



This manual covers the following models:

- **T715**

Thermostat Applications Guide

Description	
Gas or Oil Heat	Yes
Electric Furnace	Yes
Heat Pump (No Aux. or Emergency Heat)	No
Heat Pump (with Aux. or Emergency Heat)	No
Multi-stage Systems	Yes
Heat Only Systems	No
Heat Only Systems - Floor or Wall Furnaces	No
Cool Only Systems	No
Millivolt	No

Power Type

- Battery Power
- Hardwire (Common Wire)
- Hardwire (Common Wire) with Battery Backup

Table of Contents

Page

Installation Tips	2
Thermostat Quick Reference	3
Subbase Installation	4
Wiring	5-6
Technician Setup	7
Technician Setup Menu	8-9
Mounting and Battery Installation	10
Programming The Thermostat	11
Programming The Thermostat (cont)	12
Specifications	13

Una versión española de este manual puede ser descargada en www.pro1iaq.com

A trained, experienced technician must install this product.

Carefully read these instructions. You could damage this product or cause a hazardous condition if you fail to follow these instructions.

Need Help?

For assistance with this product please visit <http://www.pro1iaq.com> or call Pro1 Customer Care toll-free at 888-Pro1iaq (776-1427) during normal business hours (Mon-Fri 9 AM - 6 PM Eastern)

Wall locations

The thermostat should be installed approximately 4 to 5 feet above the floor. Select an area with average temperature and good air circulation.

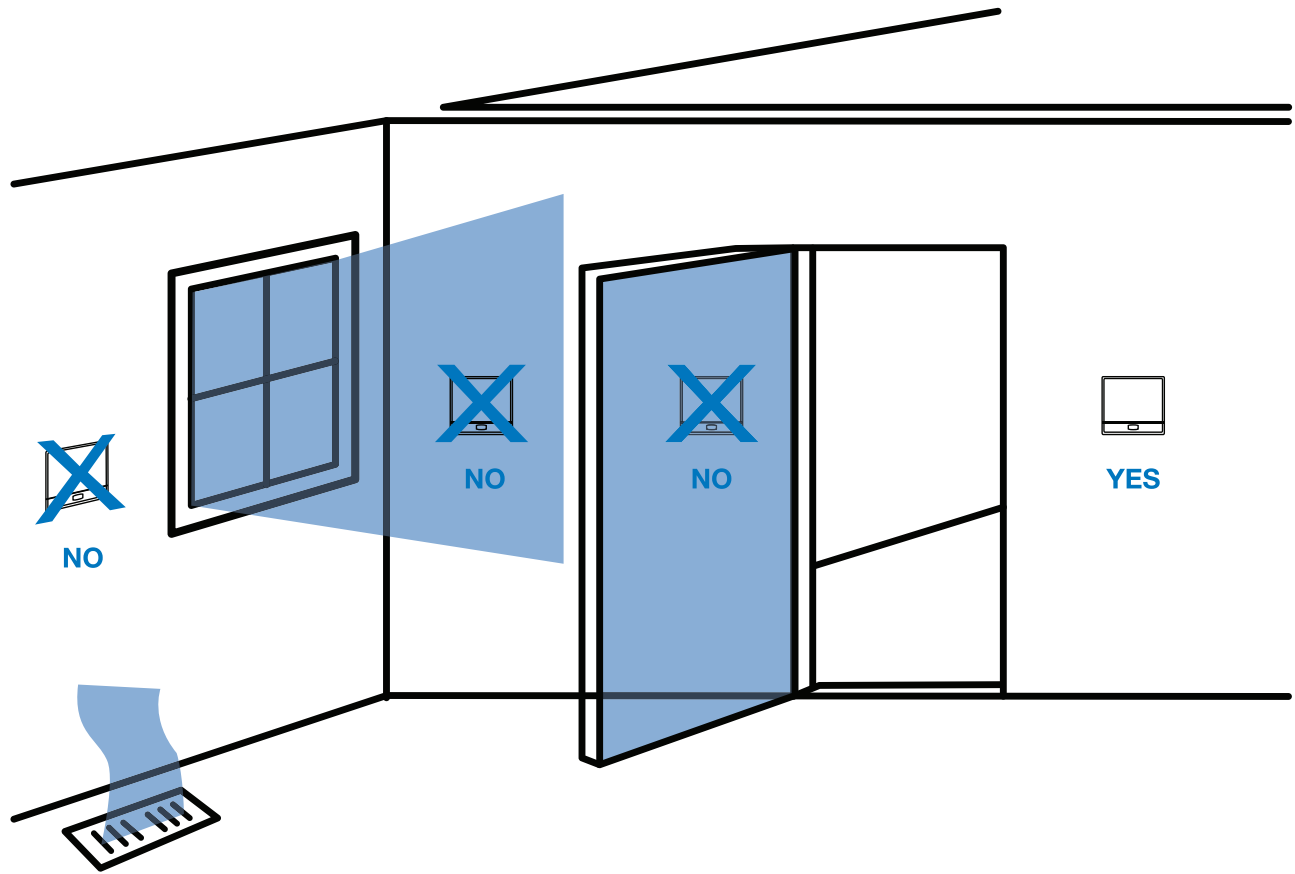

Do not install thermostat in locations:

- Close to hot or cold air ducts
- That are in direct sunlight
- With an outside wall behind the thermostat
- In areas that do not require conditioning
- Where there are dead spots or drafts (in corners or behind doors)
- Where there might be concealed chimneys or pipes
- Where appliances could radiate heat

PRO1 Tip

Pick an installation location that is easy for the user to access. The temperature of the location should be representative of the building.

Getting to know your thermostat

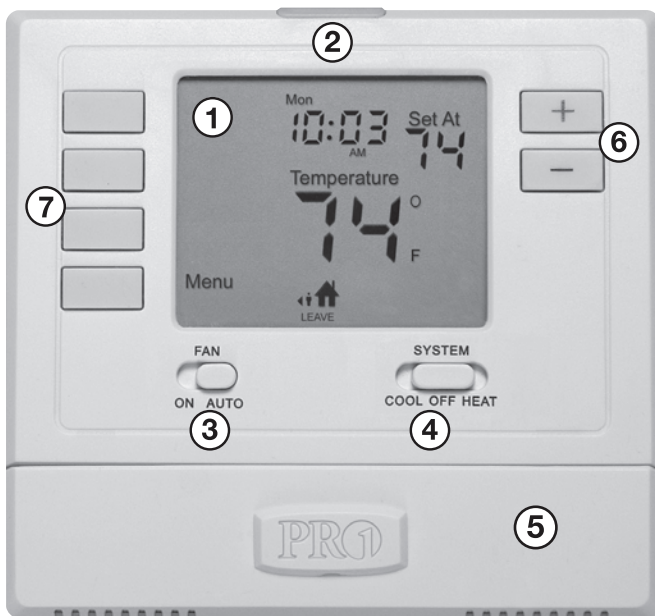

- ② Glow in the Dark Light Button
- ③ Fan Switch
- ④ System Switch
- ⑤ Easy Change Battery Door
- ⑥ Setpoint Buttons
- ⑦ User Buttons

① **LCD**

Displays the user selectable setpoint temperature.

Days of the week and time

Hold is displayed when thermostat program is permanently overridden.

Button options

Indicates the current room temperature.

System operation indicators: The **COOL**, **HEAT** or **FAN** icon will display when the **COOL**, **HEAT** or **FAN** is on.
NOTE: The compressor delay feature is active if these icons are flashing. The compressor will not turn on until the 5 minute delay has elapsed.

Low Battery Indicator: Replace batteries when indicator is shown.

Programmable Time Period Icons: This thermostat has 4 programmable time periods per day.
+1 will appear in the display when the second stage of **HEAT** or the second stage of **COOL** is active.

* * * * *

COOL HEAT FAN

Tech Set Next Step 88:88 Set At 88
Sun Mon Tue Wed Thu Fri Sat
Set Time Run Sched Temperature Hold
Set Sched Hold Prev Step 88 C F
Menu Done WAKE LEAVE RETURN SLEEP

Important:

The low battery indicator is displayed when the AA battery power is low. If the user fails to replace the battery within 21 days, the thermostat display will only show the low battery indicator as a final warning before the thermostat becomes inoperable.

Removing the private label badge

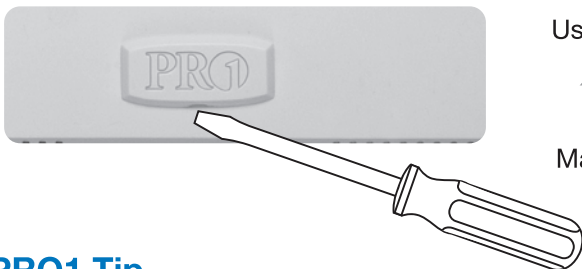

Use the bevel on lower ridge

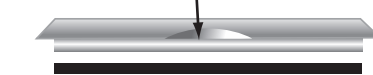

Magnet in door

Gently slide a screwdriver into the bottom edge of the badge. Gently turn the screwdriver counter clockwise. The badge is held on by a magnet in the well of the battery door. The badge should pry off easily. **Do not use force.**

PRO1 Tip

All Pro1 thermostats use the same universal magnetic badge. Visit our website at www.pro1iaq.com to learn more about our free private label program.



Caution: Electrical Hazard

Failure to disconnect the power before beginning to install this product can cause electrical shock or equipment damage.



Mercury Notice:

All of Pro1's products are mercury free. However, if the product you are replacing contains mercury, dispose of it properly. Your local waste management authority can give you instructions on recycling and proper disposal.

For vertical mount put one screw top and one screw bottom.

For horizontal mount put one screw left and one screw right.

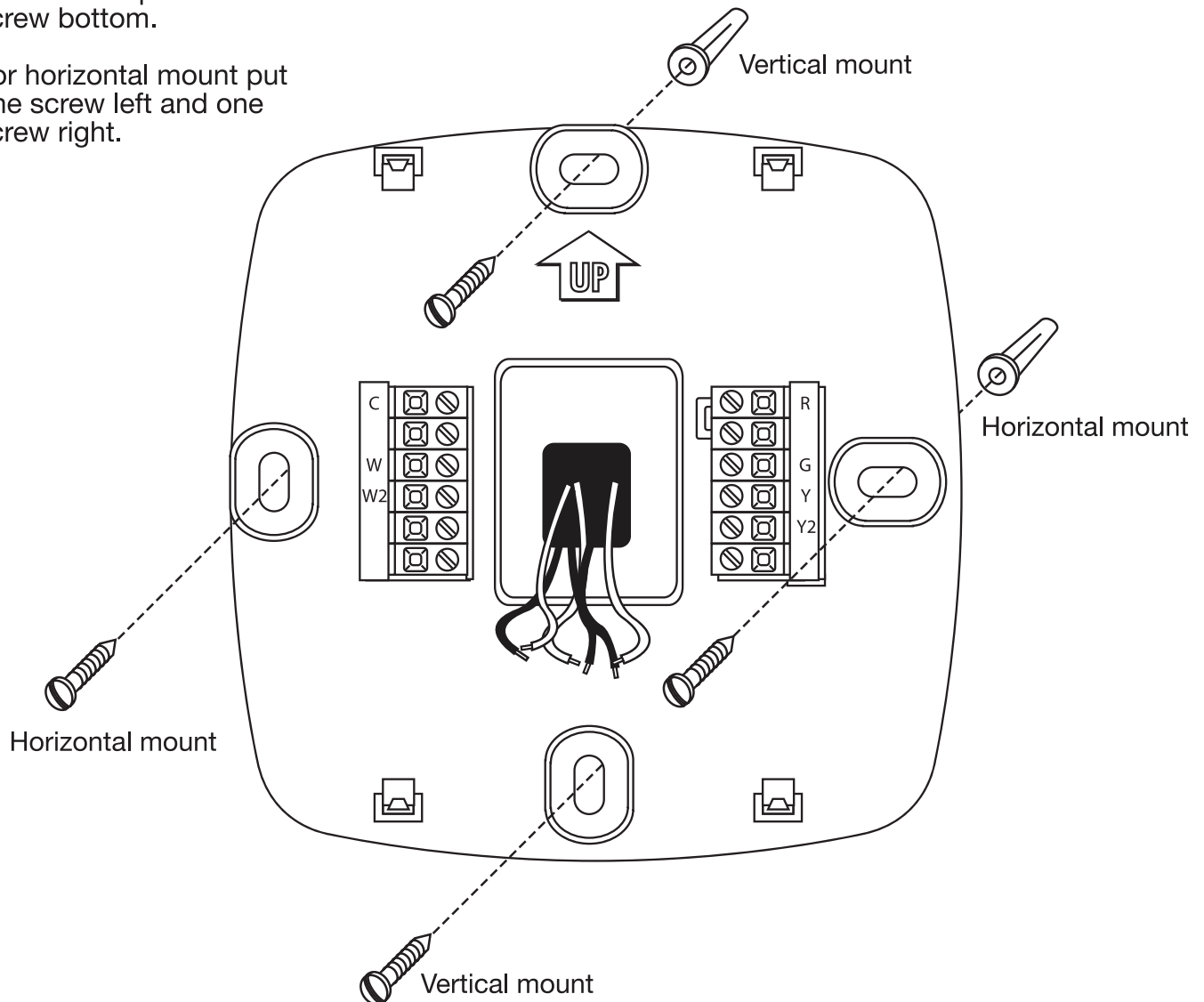



Caution: Electrical Hazard

Failure to disconnect the power before beginning to install this product can cause electrical shock or equipment damage.



Warning:

All components of the control system and the thermostat installation must conform to Class II circuits per the NEC Code.

Wiring

1. If you are replacing a thermostat, make note of the terminal connections on the thermostat that is being replaced. In some cases the wiring connections will not be color coded. For example, the green wire may not be connected to the **G** terminal.
2. Loosen the terminal block screws. Insert wires then retighten terminal block screws.
3. Place nonflammable insulation into wall opening to prevent drafts.

Terminal Designations

- | | |
|-------------------------------------|--|
| W Heat relay - Stage 1 | C Common wire from secondary side of cooling system transformer or for heat only system transformer |
| Y Compressor relay - Stage 1 | Y2 Compressor Relay - Stage 2 |
| G Fan relay | W2 Heat Relay - Stage 2 |
| R Transformer power | |

PRO1 Tips

C terminal

The C (common wire) terminal does not have to be connected when the thermostat is powered by batteries.

Wire specifications

Use shielded or non-shielded 18 - 22 gauge thermostat wire.

New Thermostat Installation Wiring

- 1 Power supply.
- 2 Optional 24 VAC common connection when thermostat is used in battery power mode.

Typical 2H/2C system: 1 transformer

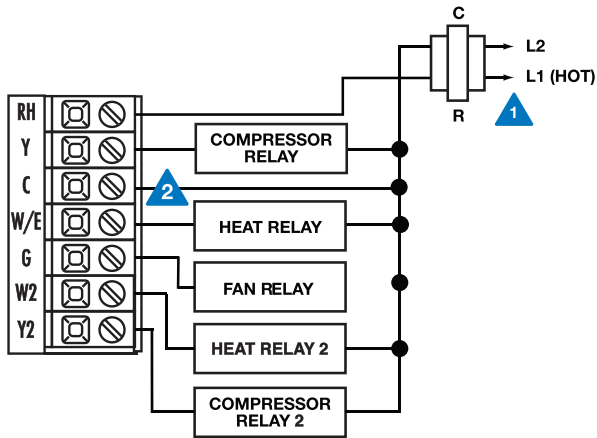

Typical heat-only system

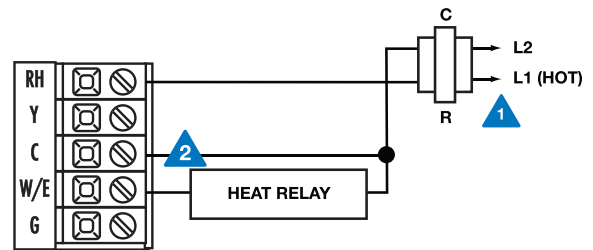

Typical heat-only system with fan

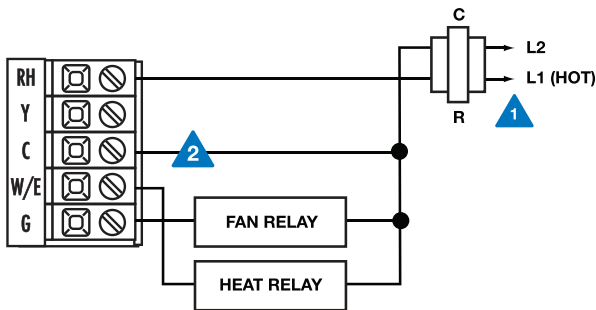

Typical cool-only system

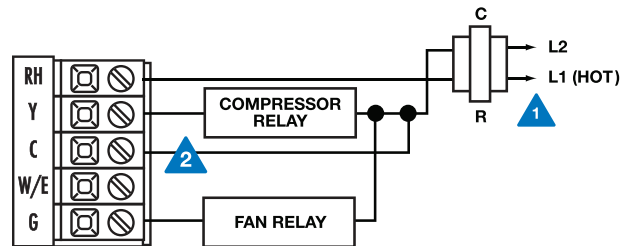

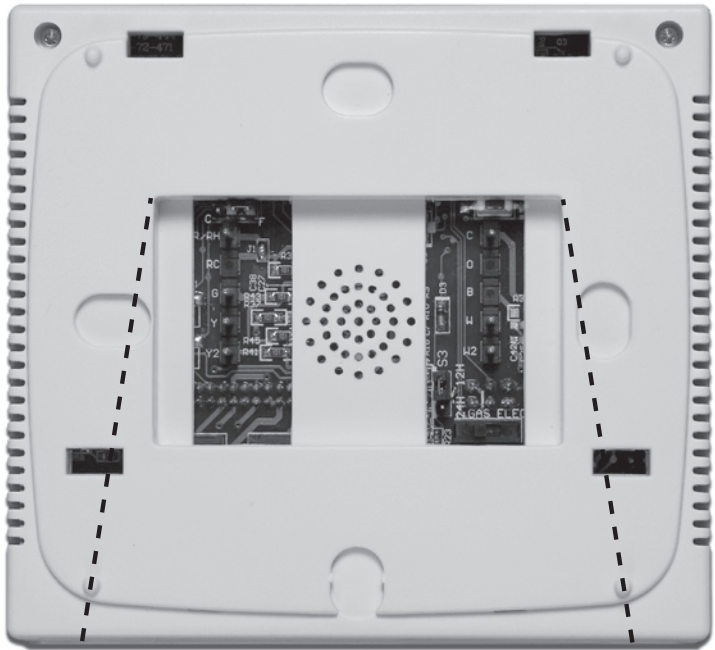

Select **F** or **C** with the jumper pin

Reset button

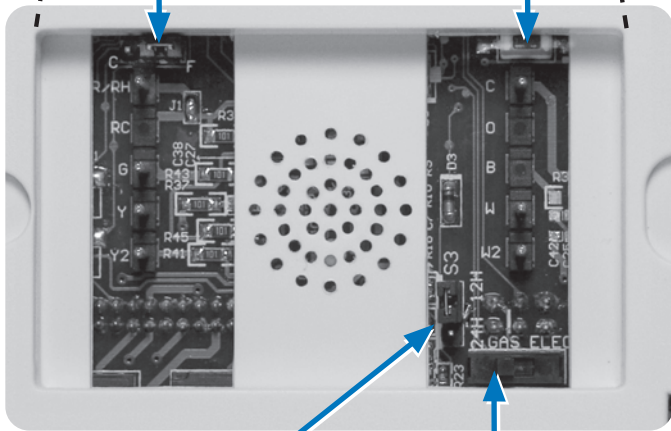

12 or 24 hour jumper pin

Set fan operation switch

Gas or Electric Setup

Gas: For systems that control the fan during a call for heat, put the fan operation switch to the **GAS** position.

Electric: The thermostat operation switch should be put in the **ELEC** position. This setting allows the thermostat to operate the fan when the fan relay is connected to the **G** terminal.

Fahrenheit/Celsius Display

Select **F** or **C** with the jumper pin on the back of the thermostat. **F** is for Fahrenheit and **C** is for Celsius.

12 or 24 Hour Time

12 or 24 hour (military time) can be selected with the jumper pin.



Important:

The **RESET** button must be pressed after changing any switch or jumper pin setting. Batteries must be installed for this operation.

Technician Setup Menu

This thermostat has a technician setup menu for easy installer configuration. To set up the thermostat for your particular application:

1. Press **MENU** button
2. Press and hold **TECH SET** button for 3 seconds. This 3 second delay is designed so that homeowners do not accidentally access the installer settings.



3. Configure the installer options as desired using the table below.

Use the or keys to change settings and the **NEXT STEP** or **PREV STEP** key to move from one option to another. **Note:** Only press **DONE** key when you want to exit the Technician Setup options.

Tech Setup Steps					
Filter Change Reminder	Room Temperature Calibration	Minimum Compressor On Time	Compressor Short Cycle Delay	Cooling Swing	Heating Swing
This feature will flash "FILT" in the display after the elapsed run time to remind the user to change the filter. A setting of "off" will disable this feature.	This feature allows the installer to change the calibration of the room temperature display. For example, if the thermostat reads 70° and you would like it to read 72° then select +2.	This feature allows the installer to select the minimum run time for the compressor. For example, a setting of 4 will force the compressor to run for at least 4 minutes every time the compressor turns on, regardless of the room temperature.	The compressor short cycle delay protects the compressor from "short cycling". This feature will not allow the compressor to be turned on for 5 minutes after it was last turned off.	The swing setting, often called "cycle rate", "differential" or "anticipation" is adjustable. A smaller swing setting will cause more frequent cycles and a larger swing setting will cause fewer cycles.	The swing setting, often called "cycle rate", "differential" or "anticipation" is adjustable. A smaller swing setting will cause more frequent cycles and a larger swing setting will cause fewer cycles.
LCD Will Show					
Adjustment Options					
You can adjust the filter change reminder from "off" to 2000 hours of runtime in 50 hour increments.	You can adjust the room temperature display to ready -4°F to +4°F above or below the factory calibrated reading.	You can select the minimum compressor run time from "off", "3", "4", or "5" minutes. If 3, 4, or 5 is selected, the compressor will run for at least the selected time before turning off.	Selecting "ON" will not allow the compressor to be turned on for 5 minutes after the last time the compressor was on. Select "off" to remove this delay.	The cooling swing setting is adjustable from ±0.4°F to ±2°F. For example: A swing setting of 0.5°F will turn the cooling on at approximately 0.5°F above the setpoint and turn the cooling off at approximately 0.5°F below the setpoint.	The heating swing setting is adjustable from ±0.4°F to ±2°F. For example: A swing setting of 0.5°F will turn the heating on at approximately 0.5°F below the setpoint and turn the heating off at approximately 0.5°F above the setpoint.
Factory Default Settings					
Off	0 °F	Off	On	0.8 °F	0.8 °F

PRO1 Tip

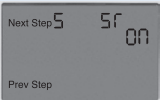
The second stage will turn on at 2x the swing setting. The second stage will turn off when 1x the swing is reached. For example, if the swing setting is .8 degrees for heating and the thermostat is set at 70°F, the first stage will turn on at approximately 69.2°F. The second stage will turn on at 68.4°F. The second stage will turn off at 69.2°F and the first will turn off at 70.8°F.

Tech Setup Steps (Continued...)	
Satisfy Setpoint	Staging Delay
<p>This feature allows the thermostat to keep multiple stages of heat or cool energized until setpoint is satisfied.</p>	<p>This feature allows a delay to occur when a second and third stage is needed. This allows the previous stage extra time to satisfy setpoint.</p>
LCD Will Show	
	
Adjustment Options	
<p>Use the + or - key to turn on or off.</p>	<p>Use the + or - key to select OFF, 5, 10, 15, 30, 45, 60, 90.</p>
Factory Default Settings	
OFF	OFF

Note:

Pro1 Standard staging logic, optional satisfy setpoint and optional staging delay allows for job by job customization that balances comfort, energy efficiency and equipment longevity.

INSTALLATION MANUAL

MOUNT THERMOSTAT & BATTERY INSTALLATION

Mount Thermostat

Align the 4 tabs on the subbase with corresponding slots on the back of the thermostat, then push gently until the thermostat snaps in place.



Battery Installation

Battery installation is optional if thermostat is hardwired (C terminal connected).

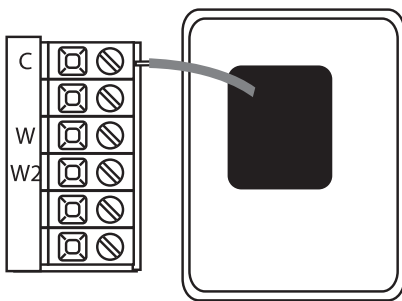

Insert 2 AA Alkaline batteries (included).

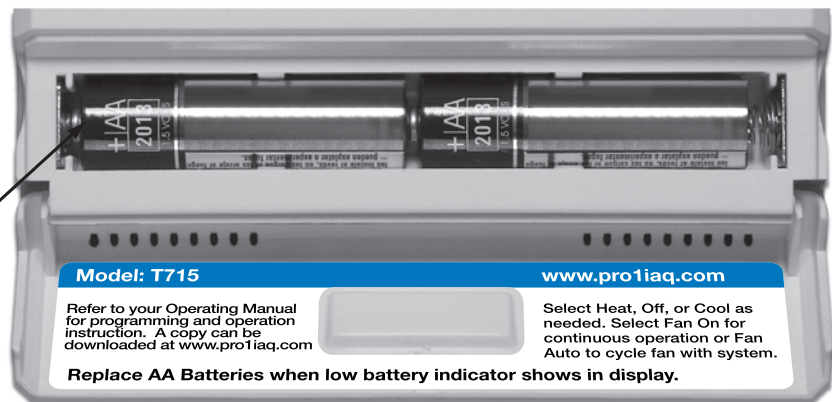

Simple operating instructions are found on the back of the battery door.

Set Time













Follow the steps below to set the day of the week and current time:

1. Press **MENU**
2. Press **SET TIME**
3. Day of the week will be flashing. Use the or key to select the current day of the week.
4. Press **NEXT STEP**
5. The current hour is flashing. Use the or key to select the current hour. When using 12-hour time, make sure the correct a.m. or p.m. choice is selected.
6. Press **NEXT STEP**
7. Minutes are now flashing. Use the or key to select current minutes.
8. Press **DONE** when completed

Programming

All programmable Pro1 thermostats are shipped with an energy saving pre-program. You can customize this default program by following the Set Program Schedule.













Your thermostat can be programmed to have all the weekdays the same, a separate program for Saturday, and a separate program for Sunday. There are four time periods for each program (**WAKE, LEAVE, RETURN, SLEEP**).

Factory Default Program				
Day of the Week	Events	Time	Setpoint Temperature (Heat)	Setpoint Temperature (Cool)
Weekday	Wake 	6 a.m.	70° F (21° C)	75° F (24° C)
	Leave 	8 a.m.	62° F (17° C)	83° F (28° C)
	Return 	6 p.m.	70° F (21° C)	75° F (24° C)
	Sleep 	10 p.m.	62° F (17° C)	78° F (26° C)
Saturday	Wake 	8 a.m.	70° F (21° C)	75° F (24° C)
	Leave 	10 a.m.	62° F (17° C)	83° F (28° C)
	Return 	6 p.m.	70° F (21° C)	75° F (24° C)
	Sleep 	11 p.m.	62° F (17° C)	78° F (26° C)
Sunday	Wake 	8 a.m.	70° F (21° C)	75° F (24° C)
	Leave 	10 a.m.	62° F (17° C)	83° F (28° C)
	Return 	6 p.m.	70° F (21° C)	75° F (24° C)
	Sleep 	11 p.m.	62° F (17° C)	78° F (26° C)

INSTALLATION MANUAL

PROGRAMMING THE THERMOSTAT

You can use the table below to plan your customized program schedule.

Programming Table				
Day of the Week	Events	Time	Setpoint Temperature (Heat)	Setpoint Temperature (Cool)
Weekday	Wake 			
	Leave 			
	Return 			
	Sleep 			
Saturday	Wake 			
	Leave 			
	Return 			
	Sleep 			
Sunday	Wake 			
	Leave 			
	Return 			
	Sleep 			

Set Program Schedule

To customize your program schedule, follow these steps

Weekday:

1. Select **HEAT** or **COOL** from the system switch.
Note: You have to program heat and cool each separately.
2. Press **MENU**
3. Press **SET SCHED**. Note: Monday-Friday is displayed and the **WAKE** icon is shown. You are now programming the wake time period for the weekday setting.
4. Time is flashing. Use the or key to make your time selection for the weekday **WAKE** time period.
5. Press **NEXT STEP**
6. The setpoint temperature is flashing. Use the or key to make your setpoint selection for the weekday wake period.
7. Press **NEXT STEP**
8. Repeat steps 4 through 7 for weekday **LEAVE** time period, for weekday **RETURN** time period, and for weekday **SLEEP** time period.

Saturday:

9. Repeat steps 4 through 7 for Saturday **WAKE** time period, for Saturday **LEAVE** time period, for Saturday **RETURN** time period, and for Saturday **SLEEP** time period.

Sunday:

10. Repeat steps 4 through 7 for Sunday **WAKE** time period, for Sunday **LEAVE** time period, for Sunday **RETURN** time period, and for Sunday **SLEEP** time period.

Specifications

The display range of temperature	41°F to 95°F (5°C to 35°C)
The control range of temperature	44°F to 90°F (7°C to 32°C)
Load rating	1 amp per terminal, 1.5 amp maximum all terminals combined
Display accuracy	± 1°F
Swing (cycle rate or differential)	Heating is adjustable from 0.2°F to 2.0°F Cooling is adjustable from 0.2°F to 2.0°F
Power source	18 to 30 VAC, NEC Class II, 50/60 Hz for hardwire (common wire) Battery power from 2 AA Alkaline Energizer batteries
Operating ambient	32° to +105° (0° to +41°C)
Operating humidity	90% non-condensing maximum
Dimensions of thermostat	4.7"W x 4.4"H x 1.1"D

Contact Us

Pro1 IAQ Inc.

1111 S. Glenstone
Suite 2-100
Springfield, MO 65804

Toll-free: 1-888-Pro1iaq (776-1427)

Toll Number (Outside the USA): 330-821-3600

Web: <http://www.pro1iaq.com>

Hours of Operation: Monday - Friday 9 AM - 6 PM Eastern