



## Wired Remote Controller XE71

(XE71-44/G)

# ***Owner's Manual***

## **Original Instructions**

---

Thank you for choosing our product.  
Please read this Owner's Manual carefully before operation and retain it for future reference.  
If you have lost the Owner's Manual visit [www.greecomfort.com/resources/dealer-resources-current-product/](http://www.greecomfort.com/resources/dealer-resources-current-product/)

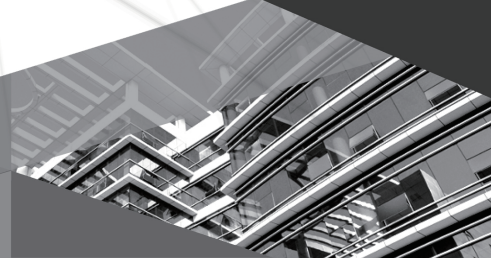

## User Notice

- ◆ Never install the wired remote controller in highly humid environments or expose to direct sunlight.
- ◆ Never drop, shake, toss or frequently disassemble the wired remote controller or the wireless remote controller.
- ◆ Never operate the wired remote controller and the wireless remote controller with wet hands.
- ◆ Do not remove or install the wired controller by yourself. If you have questions, please contact your local licensed HVAC technician.
- ◆ This wired controller is compatible with several kinds of units.  
Some functions of the wired controller are not available for certain units. For more details please refer to the owner's manual of unit. Selecting an unavailable function will do nothing and will not affect unit's operation.
- ◆ The wired controller is universal. The remote receiver is either in the indoor unit or in the wired controller. Please refer to the specific models.
- ◆ When some indoor units are connected to the wired controller and the remote controller is set in the auto mode (where the temperature adjusts automatically), the remote controller will override the wired controllers auto mode setting.



**Please read the manual carefully before installing and using this product.**

# Contents

Wired Remote Controller XE71 (XE71-44/G).....	1
1 Symbols on LCD .....	1
1.1 Outside View of the Wired Remote Controller .....	1
1.2 LCD Display of the Wired Remote Controller .....	1
2 Touch Pad.....	2
2.1 Buttons on the Wired Remote Controller .....	2
2.2 Function of the Buttons .....	3
3 Operation Instructions .....	4
3.1 On/Off .....	4
3.2 Mode Setting.....	4
3.3 Temperature Setting.....	4
3.4 Fan Setting.....	5
3.5 Timer Setting.....	5
3.6 Swing Setting .....	7
3.7 Sleep Setting.....	8
3.8 Turbo Setting.....	9
3.9 E-heater Setting .....	10
3.10 Blow Setting .....	11
3.11 Other Functions.....	12
4 Installation and Dismantlement .....	13
4.1 Connection of the Signal Line of the Wired Remote Controller .....	13
4.2 Installation of the Wired Remote Controller .....	13
4.3 Dismantlement of the Wired Remote Controller .....	16
5 Errors Display .....	16

## Wired Remote Controller XE71<sub>(XE71-44/G)</sub>

### 1 Symbols on LCD

#### 1.1 Outside View of the Wired Remote Controller



Fig.1 Outside View of the Wired Remote Controller

#### 1.2 LCD Display of the Wired Remote Controller

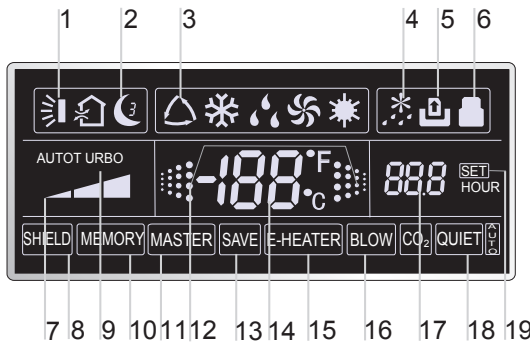

Fig.2 LCD Display of the Wired Remote Controller

Table 1

No.	Symbols	Description
1		Swing function.
2		Sleep function (Only sleep 1).
3		Running modes of the indoor unit (Cooling, Dry, Fan and Heating).
4		Defrosting function for the outdoor unit.
5		Gate-control function.
6		Lock function.
7		High, middle, low or auto fan speed of the indoor unit.
8		Shield functions (buttons, temperature, On/Off or Mode is shielded by the remote monitor).
9		Turbo function.
10		Memory function (The indoor unit resumes the original setting state after power failure and then power recovery).
11		Master wired remote controller (this function is yet unavailable for this unit).
12		It blinks under on state of the unit without operation of any button.
13		Energy-saving function (this function is yet unavailable for this unit).
14		Ambient/preset temperature value.
15		Electric auxiliary heating function. Not available in U.S.
16		Blow function.
17		Timing value.
18		Quiet function (two types: quiet and auto quiet) (this function is yet unavailable for this unit).
19	SET	It will be displayed under the debugging mode.

## 2 Touch Pad

### 2.1 Buttons on the Wired Remote Controller

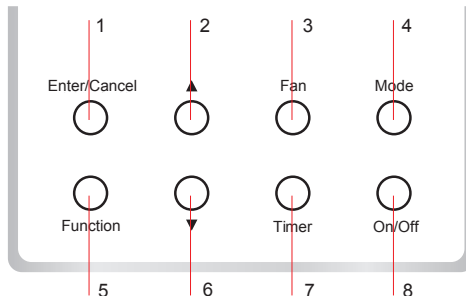



Fig. 3 Buttons on the Wired Remote Controller

## 2.2 Function of the Touch Pad Buttons

Table 2

No.	Name	Function
1	Enter/Cancel	Function selection and cancellation.
2	▲	① Running temperature setting of the indoor unit, range:61~86°F(16~30 ℃). ② Timer setting, range:0.5-24 hr.
6	▼	
3	Fan	Setting of the high/middle/low/auto fan speeds.
4	Mode	Setting the Cooling/Heating/Fan/Dry/Auto mode of the indoor unit.
5	Function	Switchover to the Turbo/Save/E-heater/Blow etc. functions.
7	Timer	Timer setting.
8	On/Off	Turn indoor unit on/off.
4+2	▲+Mode	Press for 5 secs when unit is off to Enter/Cancel the Memory function (If memory is set, indoor unit will return to the last setting upon power failure. If not, the indoor unit is defaulted to "off" after power recovery. "Memory off" is the default setting at time of delivery).
3 +6	Fan+▼	By pressing these at the same time when unit is off  will be displayed on the wired remote controller.
2 +6	▲+▼	Upon startup of the unit, if there are no problems or if the unit is off, press both at the same time for 5s to enter the lock mode where no buttons will won't respond when pressed. Repress both for 5s to cancel this operation.
4+6	Mode+▼	While "OFF" the Celsius and Fahrenheit scales can be switched by pressing "Mode" and "▼" for five seconds.
5+7	Function+Timer	While "OFF", it's possible to go into the commissioning status by pressing "Function" and "Timer" for five seconds and leaving "00" in the temperature display area. Then, pressing "Mode", adjust the options in the timer area by pressing "▲" and "▼"to select the following options: ① Indoor ambient temperature is sensed by the return air temperature sensor ( 01 displayed on the timer area). ② Indoor ambient temperature is sensed by the wired controller (02 displayed on the timer area). ③ The return air temperature sensor is selected under the cooling, dry, or fan mode; while the wired controller temperature sensor is selected under the heating or auto mode. (03 is displayed on the timer area). ④ The wired controller temperature sensor is selected under the cooling, dry, or fan mode; while the return air temperature sensor is selected under the heating mode. (04 is displayed on the timer display area).
5+7	Function+Timer	While "OFF", it is possible to go to the commissioning status by pressing "Function" and "Timer" for five seconds. Press "Mode" button until "01" icon is shown in the temperature display area. Press "▲" and "▼" to select the following available options: ① Three low levels (01) ; ② Three high levels (02).

### 3 Operation Instructions

#### 3.1 On/Off

Press On/Off to turn on the unit, press again to turn it off.

Note: The state shown in Fig.4 indicates unit is "Off" after powering on. The state shown in Fig.5 indicates the unit is "On" after powering on.

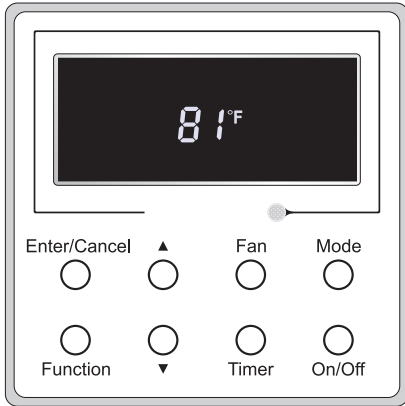

Fig. 4 "Off" State

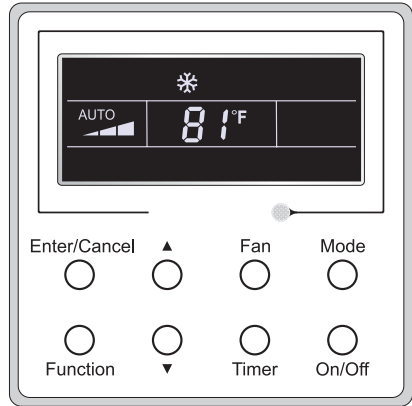
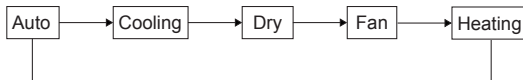

Fig. 5 "On" State

#### 3.2 Mode Setting

While in the "On" state press "Mode" to switch the operation modes in the following sequence:Auto-Cooling-Dry-Fan-Heating.



#### 3.3 Temperature Setting

Press ▲ or ▼ to increase/decrease the preset temperature. If either is pressed continuously, the temperature will be increased or decreased by 1°F(1℃) every 0.5s, as shown in Fig.6.

In the Cooling, Dry, Fan or Heating mode, the temperature setting range is 61°F~86°F(16℃~30℃). In the Auto mode, the setting temperature is not adjustable.

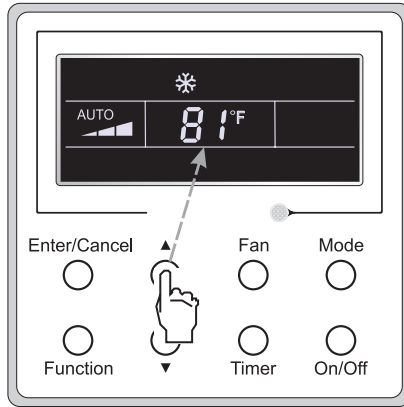

Fig.6

### 3.4 Fan Setting

In the "On"/"Off" state of the unit, press Fan and the fan speed of the indoor unit will change in the order shown in Fig.7.

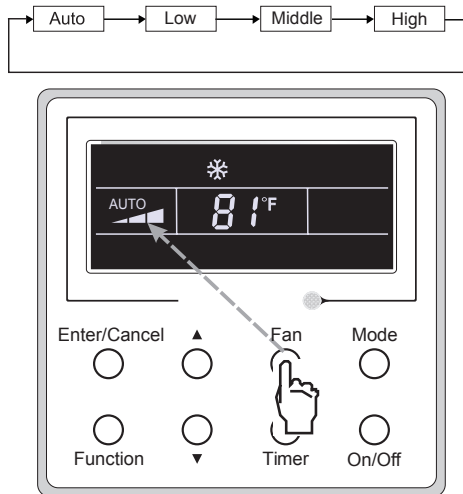

Fig.7

### 3.5 Timer Setting

In the "On"/"Off" state of the unit, press Timer to set timer off/on.

Timer "On" setting: Press "Timer", and the LCD will display "xx.x hour", with "hour" blinking. Then press ▲ or ▼ to adjust the time. Then press Enter/Cancel to confirm.

Timer "Off" setting: Press "Timer", if LCD won't display xx.x hour then it means the timer setting is canceled.

Timer "Off" setting under the "On" state of the unit is shown as Fig.8.



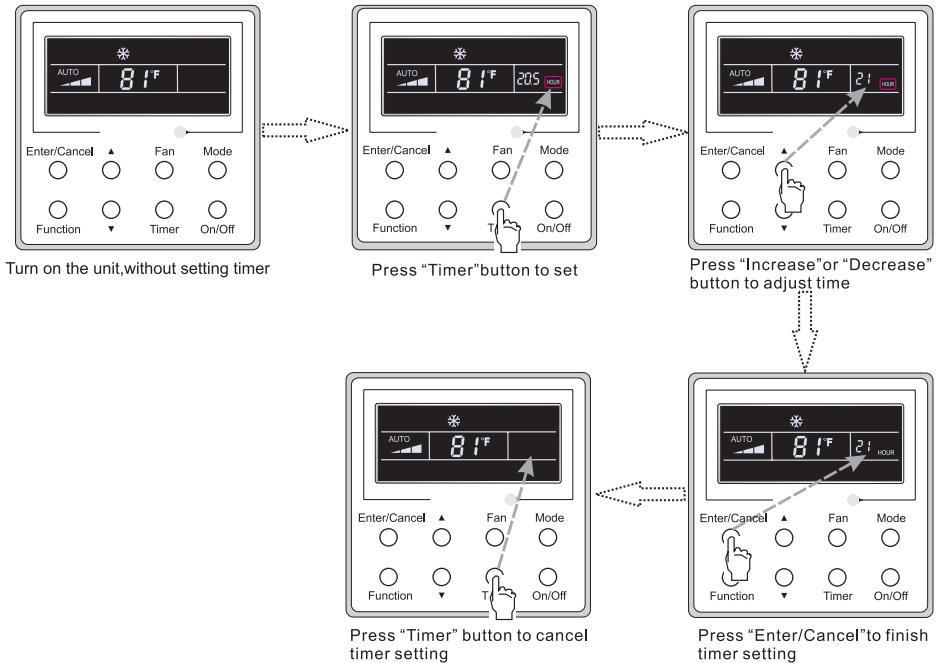



Fig. 8 Timer off Setting under the "On" State of the Unit

Timer range: 0.5-24hr. Every press of ▲ or ▼ will make the set time increased or decreased by 0.5hr. If either of them is pressed continuously, the set time will increase/ decrease by 0.5hr every 0.5s.

### 3.6 Swing Setting

Swing On: Press Function key under on state of the unit to activate the swing function. In this case,  will blink. After that, press Enter/Cancel to make a confirmation.

Swing Off: When the Swing function is on, press Function key to enter the Swing setting interface, with  blinking. After that, press Enter/Cancel to cancel this function.

Swing setting is shown as Fig.9.

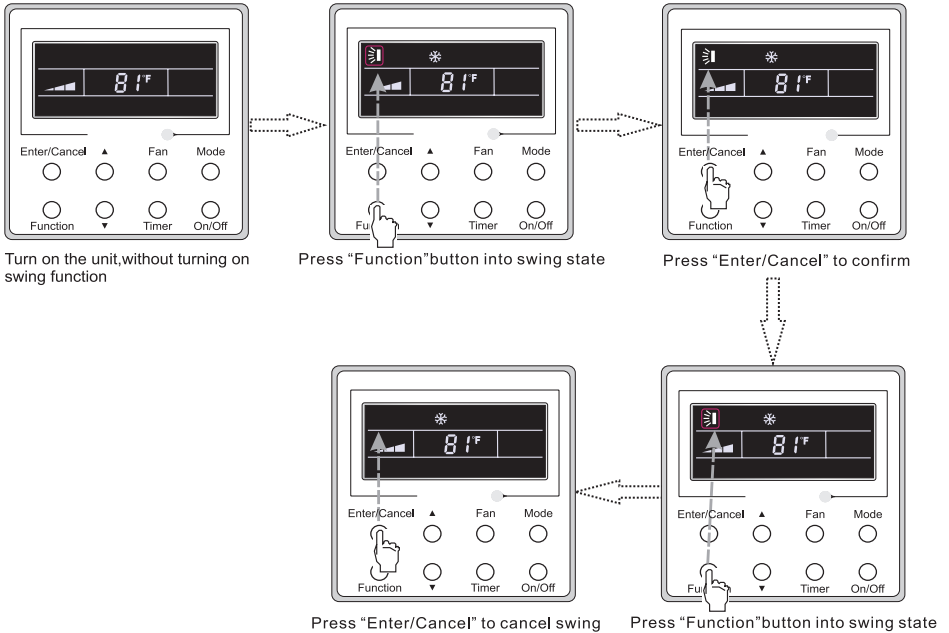

Fig. 9 Swing Setting

Note:

- ① . Sleep, Turbo or Blow setting is the same as the Swing setting.
- ② . After the setting has been done, it has to press the key "Enter/Cancel" to back to the setting status or quit automatically five seconds later.

### 3.7 Sleep Setting

**Sleep on:** Press Function under on state of the unit till the unit enters the Sleep setting interface. Press Enter/Cancel to confirm the setting.

**Sleep off:** When the Sleep function is activated, press Function to enter the Sleep setting interface. After that, press Enter/Cancel to can this function.

In the Cooling or Dry mode, the temperature will increase by 1°C after the unit runs under Sleep 1 for 1hr and 1°C after another 1hr. After that, the unit will run at this temperature.

In the Heating mode, the temperature will decrease by 1°C after the unit runs under Sleep 1 for 1hr and 1°C after another 1hr. After that, the unit will run at this temperature.

Sleep setting is shown as Fig.10.

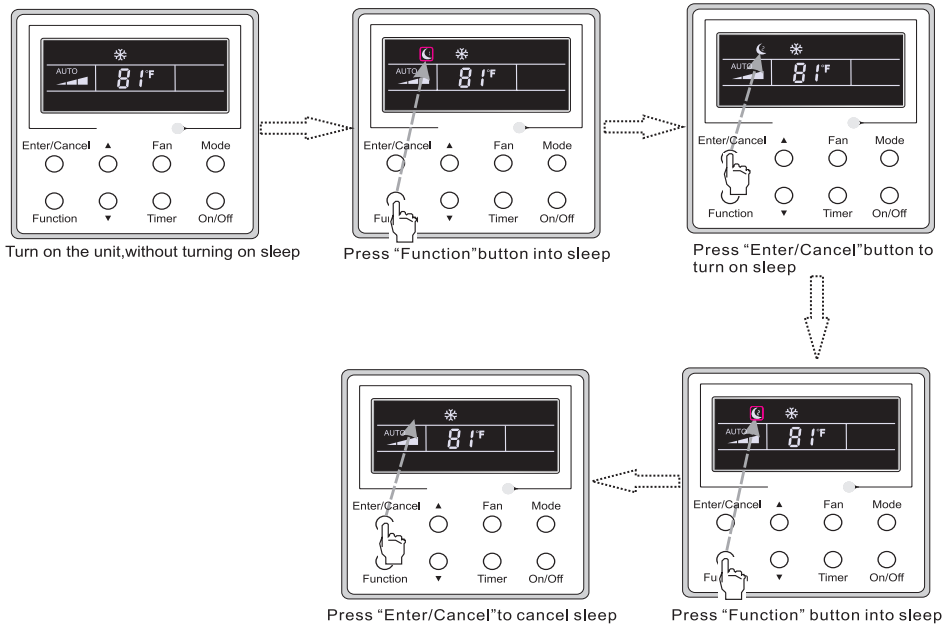

Fig. 10 Sleep Setting

### 3.8 Turbo Setting

Turbo function: The unit at the high fan speed can realize quick cooling or heating so that the room temperature can quickly approach the setting value.

In the Cooling or Heating mode, press Function till the unit enters the Turbo setting interface and then press Enter/Cancel to confirm the setting.

When the Turbo function is activated, press Function to enter the Turbo setting interface and then press Enter/Cancel to cancel this function.

Turbo function setting is as shown in Fig.11.

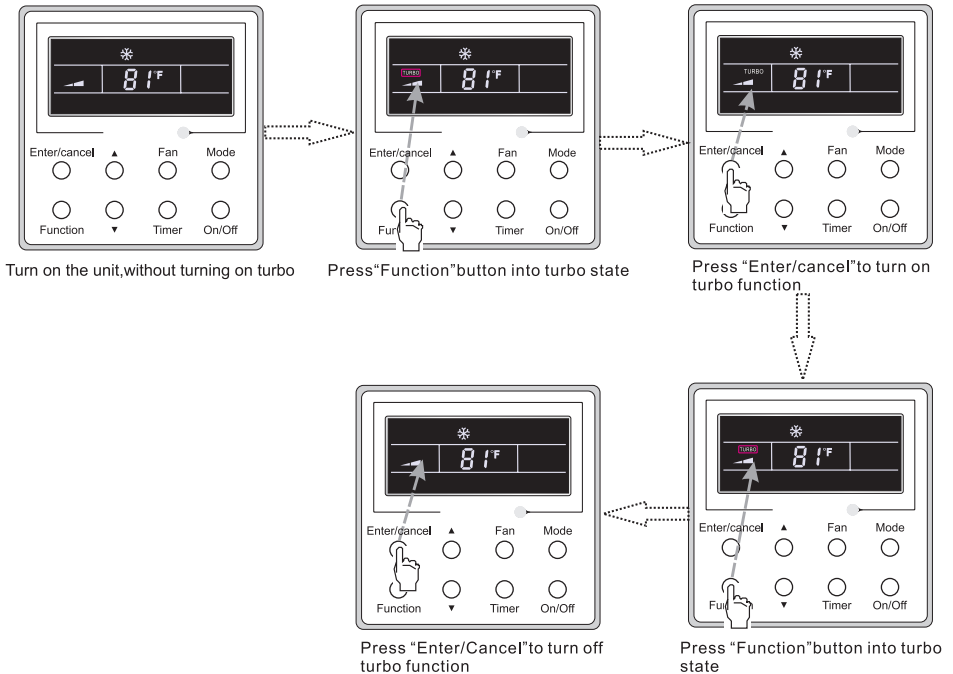

Fig.11 Turbo Setting

### 3.9 E-heater Setting

E-heater (auxiliary electric heating function): In the Heating mode, E-heater is allowed to be turned on for improvement of efficiency.

Once the wired remote controller or the remote controller enters the Heating mode, this function will be turned on automatically.

Press Function in the Heating mode to enter the E-heater setting interface and then press Enter/Cancel to cancel this function.

Press Function to enter the E-heater setting interface, if the E-heater function is not activated, and then press Enter/Cancel to turn it on.

The setting of this function is shown as Fig.12 below:

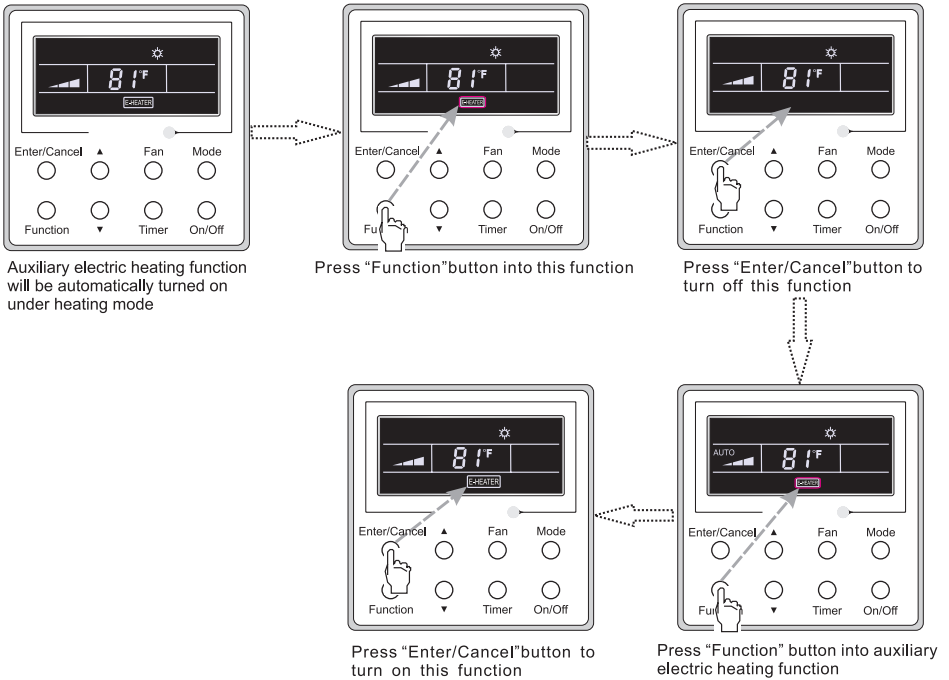

Fig.12 E-heater Setting

### 3.10 Blow Setting

Blow function: After the unit is turned off, the water in evaporator of indoor unit will be automatically evaporated to avoid mildew.

In the Cooling or Dry mode, press Function till the unit enters the Blow setting interface and then press Enter/Cancel to activate this function.

When the Blow function is activated, press Function to the Blow setting interface and then press Enter/Cancel to cancel this function.

Blow function setting is as shown in Fig.13

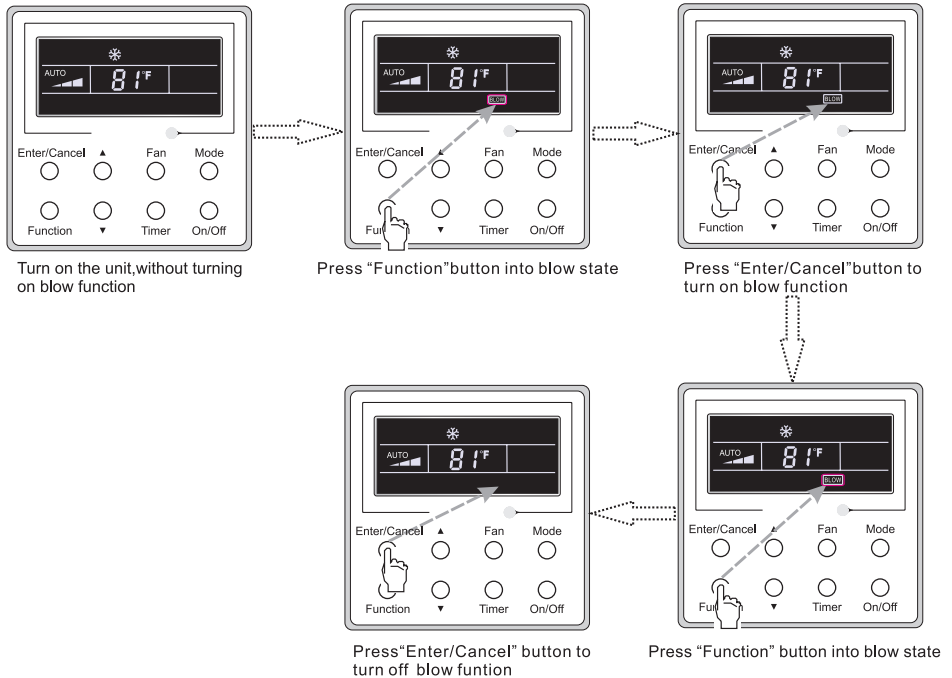

Fig.13 Blow Setting

**Notes:**

① . When the Blow function is activated, if turning off the unit by pressing On/Off or by the remote controller, the indoor fan will run at the low fan speed for 2 min, with "BLOW" displayed on the LCD. While, if the Blow function is deactivated, the indoor fan will be turned off directly.

② . Blow function is unavailable in the Fan or Heating mode.

### 3.11 Other Functions

#### (1). Lock

Upon startup of the unit without malfunction or under the “Off” state of the unit, press ▲ and ▼ at the same time for 5s till the wired remote controller enters the Lock function. In this case, LCD displays . After that, repress these two buttons at the same time for 5s to quit this function.

Under the Lock state, any other button press won't get any response.

#### (2). Memory

Memory switchover: Under the “Off” state of the unit, press Mode and ▲ at the same time for 5s to switch memory states between memory on and memory off. When this function is activated, Memory will be displayed. If this function is not set, the unit will be under the “Off” state after power failure and then power recovery.

Memory recovery: If this function has been set for the wired remote controller, the wired remote controller after power failure will resume its original running state upon power recovery.

Memory contents: On/Off, Mode, set temperature, set fan speed and Lock function.

#### (3). Selection of the Temperature Sensor

Under OFF state of the unit, press both “Function” and “Timer” for five seconds to go the commissioning status. Under this status, adjust the display in the temperature display area to “00” through the button “Mode”, and then adjust the option of the temperature sensor in the timer display area through the button ▲ or ▼.

- ① . Indoor ambient temperature is sensed at the return air inlet(01 in the timer display area).
- ② . Indoor ambient temperature is the sensed at the wired controller(02 in the timer display area).
- ③ . Select the temperature sensor at the return air inlet under the cooling, dry and fan modes, while select the temperature sensor at the wired controller under the heating and auto modes.(03 in the timer display area).
- ④ . Select the temperature sensor at the wired controller under the cooling, dry and fan modes, and select the temperature sensor at the return air inlet under the heating mode and auto modes (04 displayed in the timer display area).

After the setting, press “Enter/Cancel” to make a confirmation and quit this setting status.

Pressing the button “On/Off” also can quit this commissioning status but the set data won't be memorized.

Under the commissioning status, if there is no any operation in 20 seconds after the last button press, it will back to the previous state without memorizing the current data.

#### **Note:**

After connected with indoor unit, if the type of ambient temperature sensor has not been manually set, the wired controller will select the ambient temperature sensor according to the model of connected IDU; if it connects to cassette type IDU, duct type IDU, floor ceiling type IDU, ceiling type IDU, it will adopt ③, otherwise it will adopt ①. If the type of ambient temperature sensor is set manually, the wired controller will subject to the manual setting, and will not set according to automatic IDU model selection.

(4). Selection of the Fan Speed

Under OFF state of the unit, press both the buttons “Function” and “Timer” for five seconds to go to the commissioning status, and then adjust the display in the temperature display area to 01 through the button “Mode” and adjust the setting of the fan speed, which comes to two options.

01: Three low fan speeds; 02: Three high fan speeds

After the setting, press “Enter/Cancel” to make a confirmation and quit this setting status.

Pressing the button “On/Off” also can quit this commissioning status but the set data won’t be memorized.

Under the commissioning status, if there is no any operation in 20 seconds after the last button press, it will back to the previous state without memorizing the current data.

## 4 Installation and Dismantlement

### 4.1 Connection of the Signal Line of the Wired Remote Controller

- Open the cover of the electric control box of the indoor unit.
- Let the single line of the wired remote controller through the rubber ring.
- Connect the signal line of the wired remote controller to the 4-pin socket of the indoor unit .
- Tighten the signal wire with ties.
- The communication distance between the main board and the wired remote controller can be up to 20 meters ( the standard distance is 8 meters)

### 4.2 Installation of the Wired Remote Controller

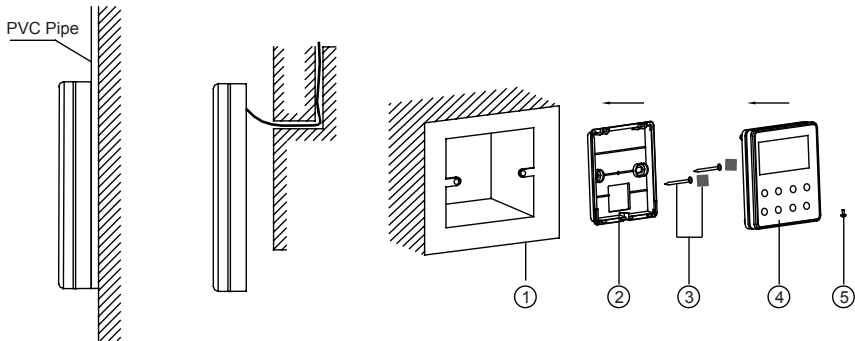

Fig.14 Accessories for the Installation of the Wired Remote Controller

Table 3

No.	1	2	3	4	5
Name	Socket box embedded in the wall	Soleplate of the Wired Remote Controller	Sponge 20×20×2 Screw M4X25	Front Panel of the Wired Remote Controller	Screw ST2.9X6



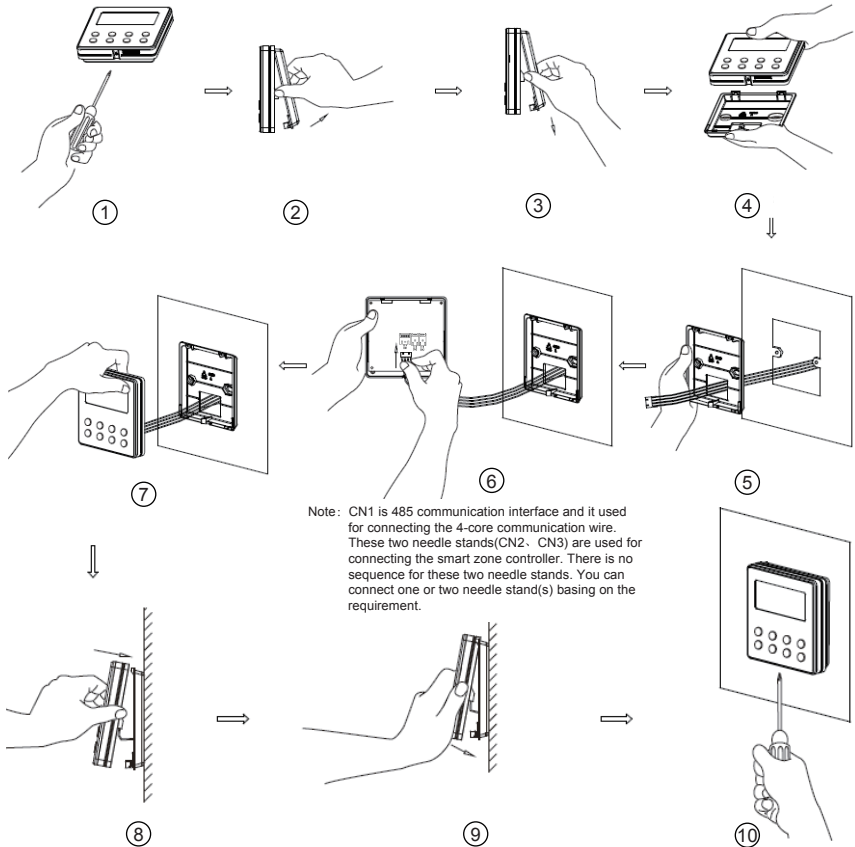

Fig.15

- Fig.15 shows the installation steps of the wired remote controller, but there are some issues that need your attention.
- (1). Prior to the installation, please firstly cut off the power supply of the wire buried in the installation hole, that is, no operation is allowed with electricity during the whole installation.
  - (2). Pull out the four-core twisted pair line from the installation holes and then let it go through the rectangular hole behind the soleplate of the wired remote controller.
  - (3). Stick the soleplate of wired controller on the wall and then use screw M4×25 to fix soleplate and installation hole on wall together, attach the sponge 20×20×2 at the screw hole and then press it with fingers to make sure it's attached firmly.
  - (4). Insert the four-core twisted pair line into the slot of the wired remote controller and then buckle the front panel and the soleplate of the wired remote controller together.
  - (5). Finally, fix the front panel and the soleplate of the wired remote controller tightly by screws ST2.9X6.

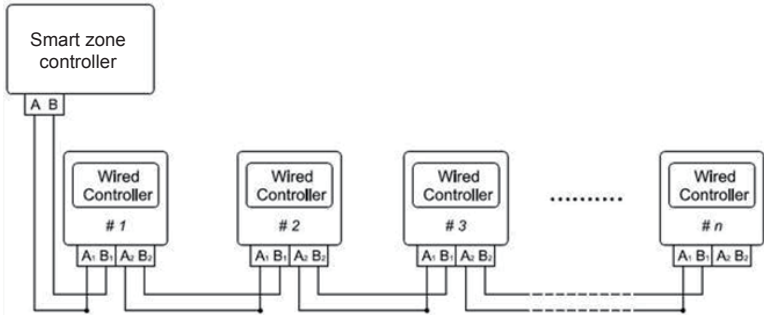

Fig.16

Fig.16 shows the schematic diagram of control system connection. XE71(XE71-44/G) can connect the smart zone controller (integrated control system). “n” indicates the number of communication node address (programmable wired controller XE71). The complete system is composed of the smart zone controller, wired controller XE71 and communication cable. The wired controller XE71 can support 16 communication node addresses at the most (n≤16).

Terminal A and terminal B of the smart zone controller are respectively connected to the corresponding communication needle stand terminal of the #1wired controller by the communication cable; the other needle stand of #1 wired controller is connected to the #2 wired controller through the telecommunication cable and so forth until connect to the #n wired controller. Except the last wired controller in the control system (only use CN2 or CN3, and the other one will not be connected), there’s no the sequence and the importance for the wired controller. The series number in the figure is only for the sake of clarity.

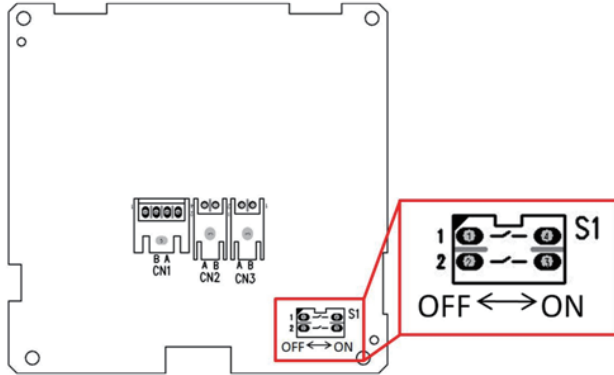

Fig.17

Fig.17 shows schematic diagram of DIP switch. There is a 2-bit DIP switch on the main board of wired controller XE71(XE71-44/G). As for the last #n wired controller in the control system, the 1-bit and the 2-bit of the DIP switch should be manually pulled to position “on” and position “off” respectively. The DIP switches of other wired controllers should be kept at the initial ex-factory status (1-bit and 2-bit are set at position “off”).

**⚠ CAUTION!**

Please pay special attention to the following during the installation to avoid any problems with the air conditioning unit due to electromagnetic interference.

- ① . Separate the signal and communication lines of the wired remote controller from the power

cord and connection lines between the indoor and outdoor unit, with a minimum interval of 20cm, otherwise the communication of the unit will probably work abnormally.

② . If the air conditioning unit is installed where is vulnerable to electromagnetic interference, then the signal and communication lines of the wired remote controller must be the shielding twisted pair lines.

### 4.3 Dismantlement of the Wired Remote Controller

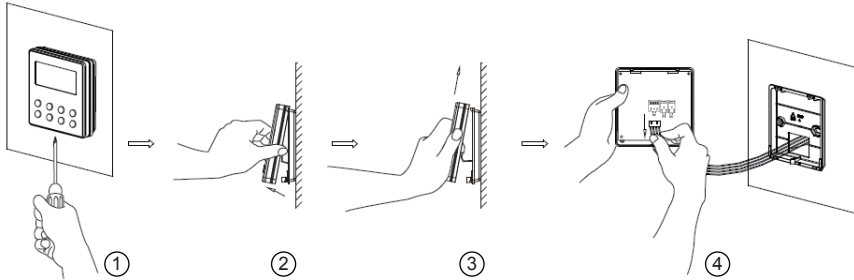

## 5 Errors Display

If there is an error occurring during the operation of the system, the error code will be displayed on the LCD, as show in Fig.18. If multi errors occur at the same time, their codes will be displayed circularly.

**Note:** In event of any error, please turn off the unit and contact the professionally skilled personnel.

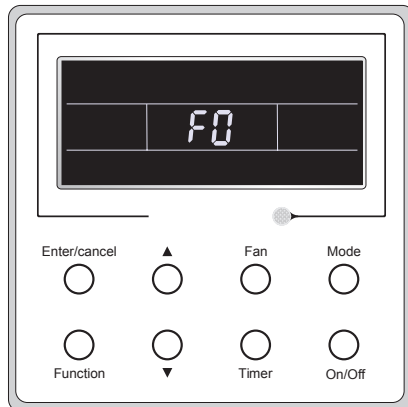

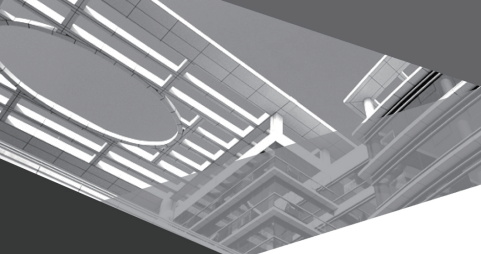

Fig.18

Table 4 Meaning of Each Error

Error	Error Code	Error	Error Code
Return air temperature sensor open/short circuited	F1	Drive board communication error	P6
evaporator temperature sensor open/short circuited	F2	Compressor overheating protection	H3
Indoor unit liquid valve temperature sensor open/short circuited	b5	Indoor and outdoor units unmatched	LP
Indoor gas valve temperature sensor open/short circuited	b7	Communication line misconnected or expansion valve error	dn
IPM temperature sensor open/short circuited	P7	Running mode conflict	E7
Outdoor ambient temperature sensor open/short circuited	F3	Pump-down	Fo
Outdoor unit condenser mid-tube temperature sensor open/short circuited	F4	Defrost or oil return	
Discharge temperature sensor open/short circuited	F5	Forced defrosting	H1
Indoor and outdoor communication error	E6	Compressor startup failure	Lc
DC bus under-voltage protection	PL	High discharge temperature protection	E4
DC bus over-voltage protection	PH	Overload protection	E8
Compressor phase current sensing circuit error	U1	Whole unit over-current protection	E5
Compressor demagnetization protection	HE	Over phase current protection	P5
PFC protection	Hc	Compressor desynchronizing	H7
IPM Temperature Protection	P8	IPM Current protection	H5
Over-power protection	L9	Compressor phase loss/reversal protection	Ld
System charge shortage or blockage protection	F0	Frequency restricted/reduced with whole unit current protection	F8
Capacitor charging error	PU	Frequency restricted/reduced with IPM current protection	En
High pressure protection	E1	Frequency restricted/reduced with high discharge temperature	F9
Low pressure protection	E3	Frequency restricted/reduced with anti-freezing protection	FH
Compressor stalling	LE	Frequency restricted/reduced with overload protection	F6
Over-speeding	LF	Frequency restricted/reduced with IPM temperature protection	EU
Drive board temperature sensor error	PF	Indoor unit full water error	E9
AC contactor protection	P9	Anti-freezing protection	E2
Temperature drift protection	PE	AC input voltage abnormal	PP
Sensor connection protection	Pd	Whole unit current sensing circuit error	U5
DC bus voltage drop error	U3	4-way valve reversing error	U7
Outdoor fan 1 error protection	L3	Motor stalling	H6
Outdoor fan 2 error protection	LA	PG motor zero-crossing protection	U8
compressor inhalation temperature sensor error	dc		



**GREE ELECTRIC APPLIANCES, INC. OF ZHUHAI**

Add: West Jinji Rd, Qianshan, Zhuhai, Guangdong, China, 519070

Tel: (+86-756) 8522218

Fax: (+86-756) 8669426

E-mail: [gree@gree.com.cn](mailto:gree@gree.com.cn) [www.gree.com](http://www.gree.com)

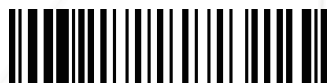

600005061061