



HART **COOLEY**[®]
install confidence.

Type B Gas Vent Systems
Edition 8

3
LIMITED WARRANTY
TYPE B GAS VENT
HART & COOLEY, INC.



- Contact your customer service representative or territory sales manager for pricing and availability.
- Free freight when your total spend is a minimum of \$2600.*

Thousands of HVAC products ready to ship.



heatfab.



Residential Vent & Chimney

Vent:

Standard efficiency b-vent, high efficiency polypropylene, special gas vent for condensing, near-condensing, and non-condensing vent systems. Stock residential diameters and system components available in 3" – 14". Additional sizes available up to 30". Direct vent systems also available. Premium quality materials and designs backed by UL standards.

Chimney:

All fuel chimney systems for venting wood, coal, oil, or gas. Available in residential diameters 4" – 8". Additional sizes available up to 24". Pellet venting systems for gas, wood pellet, and bio-fuels. Stainless steel inner and outer materials. Variety of installer friendly components backed by UL standards.

Chimney Liner:

Aluminum and stainless steel. Lengths available up to 50'. Standard diameters available up to 8". Variety of installer friendly components backed by UL standards.



Grilles, Registers, & Diffusers

A full line for residential and commercial applications. Offered in steel, aluminum and plastic. Many sizes in stock for quick shipment.



Flexible Air Duct

Flexible air duct systems UL Greenguard Gold certified for residential and commercial applications. Complete line of R-4.2, R-6.0, and R-8.0 available in many outer jacket and core combinations from 3" - 24" diameters and 25' - 50' lengths. Flexible aluminum, duct, duct sleeves and uninsulated flex duct also available.

MILCOR.

Interior Access Doors

Access Doors – High quality and affordable interior access doors for all types of requirements. In stock or custom.



Roof Top Products

New construction and retrofit drain systems, flashings, expansion joint covers, equipment rails and curbs, duct supports and pipe mounting pedestals. In stock, or made to order.

WARD®

Duct Components

Components and accessories for the residential and commercial HVAC and sheet metal industries including flange, rail, corners, hangers & strapping, and duct access doors.



Filters

A complete line of Multi-Pleat or Commercial & Industrial Disposable panel filters, available in fiberglass and polyester.

*Some restrictions may apply.

Table of Contents

About	2
Construction Features	3

Type B Round Gas Vent Pipe & Fittings

RP	Round Pipe 3" through 12"	4
R	Round Pipe 14" through 30"	5
RPA/R18A	Adjustable Length Pipe	6
REA90	0-90° Adjustable Elbow	6
REA60	60/45° Adjustable Elbow	7
R45	45° Elbow	7
REA45	45° Adjustable Elbow	7
RT	Tee	8
RTC	Tee Cap	8
RYF	Wye	9
RDH	Draft Hood Connector	9
RHW	Rain Cap 3" through 8"	10
RWW	High Wind Cap	10
CU	Universal Cap 10" through 30"	10
C	Metal Cap 14" through 30"	11
RN	Increaser	11
RIX	Universal Increaser/Adapter	11
RIX	Increaser	12
RRA	Female Adapter	12
RAA	Male Adapter	13
RA	Male Adapter	13
RF	Adjustable Roof Flashing Flat to 6/12	14
RFA	Adjustable Roof Flashing 6/12 to 12/12	14
RTF	Tall Cone Roof Flashing	15
RS	Storm Collar 3" through 6"	15
RS	Adjustable Storm Collar 7" through 12"	15
SC	Adjustable Storm Collar 14" through 30"	16
RGS	Gripper Support 3" through 6"	16
FSP	Firestop Support 3" through 8"	17
SP	Support Plate 10" through 30"	17
RPC	Pipe Collar 3" through 8"	17
RWT	Wall Thimble	18
RWB	Wall Bracket	18

RFS	Firestop Spacer	18
SFC	Single-Wall Flexible Gas Vent Connector	19
DFC	Double-Wall Flexible Gas Vent Segment	19

Type B Oval Gas Vent Pipe & Fittings

OP	Oval Pipe	20
OPA	Adjustable Oval Pipe	20
OES45	Standard Elbow	21
OEF45	Flat Elbow	21
OT	Standard Oval Tee	21
OBC	Tee Support	22
OTC	Oval Tee Cap	22
OAR	Oval-to-Round Adapter	22
OARA	Oval-to-Round Adapter	23
RAO	Round-to-Oval Adapter	23
OCP	Plate Spacers	23
OBPWS	Hold-Down Plate	24
OFS	Firestop Spacers	24
OC	Oval Cap 4"	24
ECW	Cap 4"	25
OF	Oval Flashing	25
OSC	Oval Storm Collar	25

Type B Gas Vent Installations

Gas Appliance Chimney Liner Systems

ALK	Basic Kit	27
ALKE	Extension Kit	27
ALK-FS	Insulated Sleeve	28
ALK-FC	Flex Coupler	28
FX-PD	Pull Down	28
ALK-VA	Adapters	29
RLA	Female B-Vent Adapter	29

Hart & Cooley Type B Gas Vent

Safe. Durable. Easy to install. The total package.

Safety:

The *Hart & Cooley*® double-wall, air-insulated **B-Vent** system is secured by locking joints. Properly installed, the vent won't come apart through vibration, and offers protection against vent failure or fire hazard. **Type B Gas Vent** is designed for negative pressure applications and flue gas temperatures not exceeding 400°F above ambient for Category I appliances.

Durability:

By using high-quality materials and skilled workmanship, our galvanized outer pipe and aluminum inner pipe provide protection against corrosion and external damage.

Easy and Secure Installation:

Install with confidence! *Hart & Cooley's* simple two step engagement helps installers achieve installation quickly and easily. Simply engage pipe sections and secure by sliding the lock ring over security tabs. This unique system creates a strong connection without the use of screws. With our complete offering of fittings, supports, and caps, *Hart & Cooley B-Vent* is your most valuable teammate to complete any installation.

Warranty

Hart & Cooley warrants **type-B gas vent** for a period of twelve (12) months after shipment, ensuring product is free from material or workmanship defect under normal service and use for which the products were designed.

Customer Service & Tech Support

Have a question about a product or installation? Our customer service & technical support staff is readily available to take your call and make your job easier.

Checkout our website, which offers a convenient search tool and contains our entire line of products in a user-friendly format.



Hart & Cooley, Inc.

5030 Corporate Exchange Blvd. SE
Grand Rapids, MI 49512

P (800) 433-6341

F (800) 223-8461

hartandcooley.com

Construction Features

Sizes 3" to 12" diameters

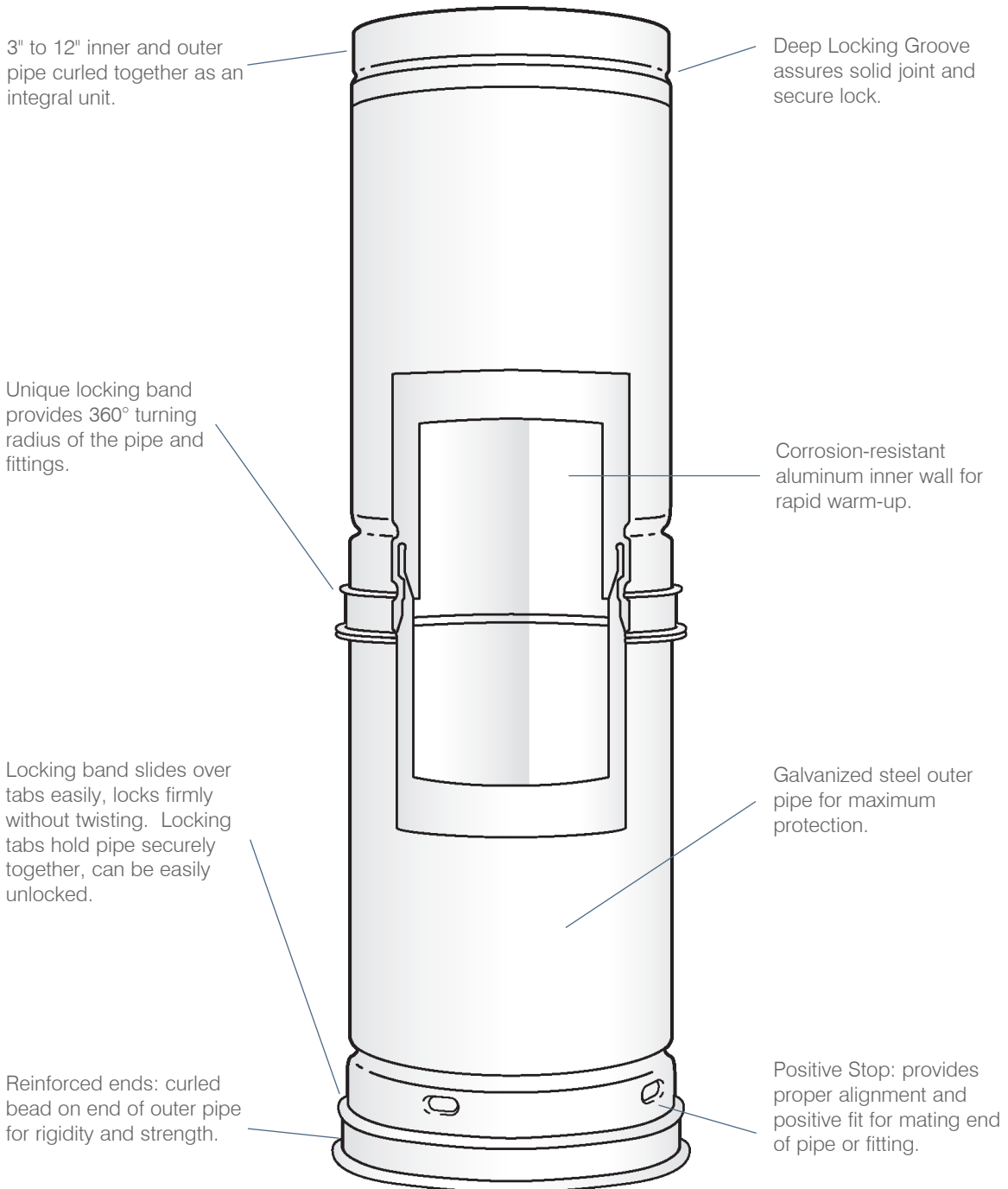

Hart & Cooley® B-Vent
complies with the latest Underwriters Laboratories Standard No. 441

Type B Round Gas Vent Pipe & Fittings

Round Pipe - RP*

3" through 12"

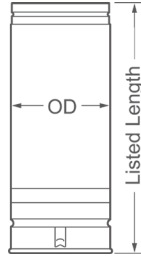

Lock-Ring Style

- Assembled length is the total length less overlap
 3" to 12" has 1 3/8" overlap
 14" to 30" has 1" overlap
- Outside Diameter (OD)
 Sizes 3" through 6" is size plus 1/2"
 Sizes 7" through 30" is size plus 1"
- The allowable minimum clearance to combustibles is 1"

Size	Model Number	Listed Length	Size	Model Number	Listed Length
3"	3RP6	6"	6"	6RP6	6"
	3RP12	12"		6RP12	12"
	3RP18	18"		6RP18	18"
	3RP24	24"		6RP24	24"
	3RP3	36"		6RP3	36"
	3RP4	48"		6RP4	48"
	3RP5	60"		6RP5	60"
4"	4RP6	6"	7"	7RP12	12"
	4RP12	12"		7RP18	18"
	4RP18	18"		7RP24	24"
	4RP24	24"		7RP3	36"
	4RP3	36"		7RP4	48"
	4RP4	48"		7RP5	60"
	4RP5	60"		8RP12	12"
5"	5RP6	6"	8"	8RP18	18"
	5RP12	12"		8RP24	24"
	5RP18	18"		8RP3	36"
	5RP24	24"		8RP4	48"
	5RP3	36"	8RP5	60"	
	5RP4	48"	10"	10RP18	18"
	5RP5	60"		10RP24	24"
		10RP3		36"	
		12"	12RP18	18"	
			12RP24	24"	
			12RP3	36"	

A full set of installation instructions are supplied with caps and supports.

*Denotes UL listing

Round Pipe - R*

14" through 30"

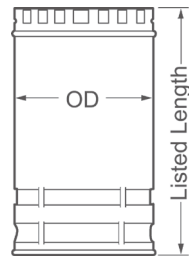

Snap-Lock Style

Size	Model Number	Listed Length
14"	14R12	12"
	14R18	18"
	14R24	24"
	14R3	36"
16"	16R12	12"
	16R18	18"
	16R24	24"
	16R3	36"
18"	18R12	12"
	18R18	18"
	18R24	24"
	18R3	36"
20"	20R12	12"
	20R18	18"
	20R24	24"
	20R3	36"
22"	22R12	12"
	22R18	18"
	22R24	24"
	22R3	36"
24"	24R12	12"
	24R18	18"
	24R24	24"
	24R3	36"
26"	26R12	12"
	26R18	18"
	26R24	24"
	26R3	36"
28"	28R12	12"
	28R18	18"
	28R24	24"
	28R3	36"
30"	30R12	12"
	30R18	18"
	30R24	24"
	30R3	36"

Adjustable Length Pipe - RPA*/R18A

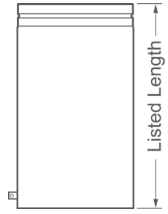

- 12" length is adjustable 1" to 10"
- 18" length is adjustable 1" to 16"

Model Number	Size	Listed Length
3RPA	3"	12"
4RPA	4"	12"
5RPA	5"	12"
6RPA	6"	12"
7RPA	7"	18"
8RPA	8"	18"
10RPA	10"	18"
12RPA	12"	18"
14R18A	14"	18"
16R18A	16"	18"
18R18A	18"	18"
20R18A	20"	18"
22R18A	22"	18"
24R18A	24"	18"
26R18A	26"	18"
28R18A	28"	18"
30R18A	30"	18"

Adjustable Elbow - REA90*

0-90°

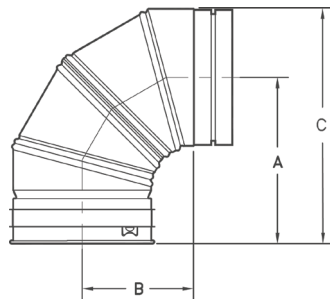

Model Number	Size	A	B	C
3REA90	3 1/2"	5 1/2"	3 3/4"	7 1/4"
4REA90	4"	6"	4 1/4"	8 1/4"
5REA90	5"	6 1/2"	4 3/4"	9 1/4"
6REA90	6"	7"	5 1/4"	10 1/4"
7REA90	7"	7 3/4"	6"	11 3/4"
8REA90	8"	8 1/4"	6 1/2"	12 3/4"

Adjustable Elbow - REA60*

60/45°

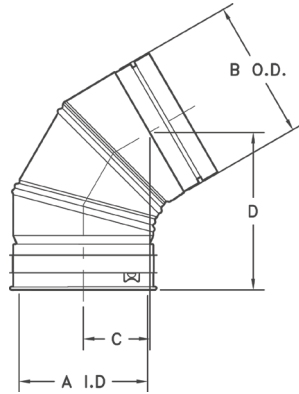

Model Number	Size	A I.D.	B O.D.	C	D
3REA60	3"	3"	3 1/2"	1 7/8"	5 1/4"
4REA60	4"	4"	4 1/2"	2 1/8"	5 1/2"
5REA60	5"	5"	5 1/2"	2 1/4"	6"
6REA60	6"	6"	6 1/2"	2 5/8"	6 3/8"

Adjustable Elbow - REA45*

45°

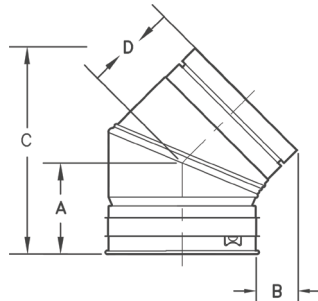

Model Number	Size	A	B	C	D
7REA45	7"	4 3/8"	2 5/8"	10 3/8"	4 3/4"
8REA45	8"	4 5/8"	2 7/8"	11 1/8"	4 3/4"
10REA45	10"	5"	3 1/4"	12 3/4"	4 3/4"
12REA45	12"	5 1/2"	3 3/4"	13 3/4"	4 3/4"

Elbow - R45*

45°

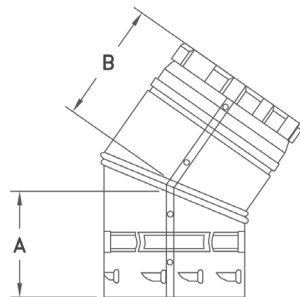

Model Number	Size	A	B
14R45	14"	6 5/8"	6 1/2"
16R45	16"	7"	7"
18R45	18"	7 9/16"	7 1/2"
20R45	20"	8 1/2"	8 5/8"
22R45	22"	8"	7 5/8"
24R45	24"	8 5/8"	8 5/16"
26R45	26"	9"	9"
28R45	28"	9 1/2"	9 1/2"
30R45	30"	10"	10"

- 14" elbow is adjustable
- 16" through 30" elbows are fixed

Tee - RT*

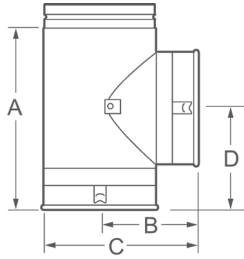

Model Number	Size	A	B	C	D
3RT3	3" x 3" x 3"	7 1/2"	4 1/2"	6 1/4"	4 1/2"
4RT4	4" x 4" x 4"	8 1/2"	5"	7 1/4"	5"
5RT5	5" x 5" x 5"	9 1/2"	5 1/2"	8 1/4"	5 1/2"
5RT4	5" x 5" x 4"	9 1/2"	5 1/2"	8 1/4"	5 1/2"
5RT3	5" x 5" x 3"	9 1/2"	5 1/2"	8 1/4"	5 1/2"
6RT6	6" x 6" x 6"	10 1/2"	6"	9 1/4"	6"
6RT4	6" x 6" x 4"	10 1/2"	6"	9 1/4"	6"
6RT3	6" x 6" x 3"	10 1/2"	6"	9 1/4"	6"
7RT7	7" x 7" x 7"	11 1/2"	6 1/2"	10 3/4"	6 3/4"
8RT8	8" x 8" x 8"	12 1/2"	7"	11 3/4"	7 1/4"
10RT10	10" x 10" x 10"	14 1/2"	8"	13 3/4"	8 1/4"
12RT12	12" x 12" x 12"	16 1/2"	9"	15 3/4"	9 1/4"
14RT	14" x 14" x 14"	24"	11 3/4"	19 1/4"	12"
16RT	16" x 16" x 16"	26"	13"	21 1/2"	13 1/4"
18RT	18" x 18" x 18"	28 1/2"	14 1/4"	23 3/4"	14 1/2"
20RT	20" x 20" x 20"	30"	15 1/2"	26"	15 3/4"
22RT	22" x 22" x 22"	33"	16 3/4"	28 1/4"	17"
24RT	24" x 24" x 24"	36"	18"	30 1/2"	18 1/4"
26RT	26" x 26" x 26"	38"	19"	32 1/2"	19 1/4"
28RT	28" x 28" x 28"	40"	20"	34 1/2"	20 1/4"
30RT	30" x 30" x 30"	42"	21"	36 1/2"	21 1/4"

Tee Cap - RTC

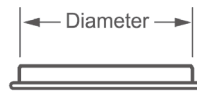
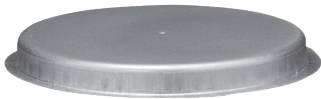

Model Number	Diameter Size
3RTC	3"
4RTC	4"
5RTC	5"
6RTC	6"
7RTC	7"
8RTC	8"
10RTC	10"
12RTC	12"
14RTCP	14"
16RTCP	16"
18RTCP	18"
20RTCP	20"
22RTCP	22"
24RTCP	24"
26RTCP	26"
28RTCP	28"
30RTCP	30"

Wye - RYF*

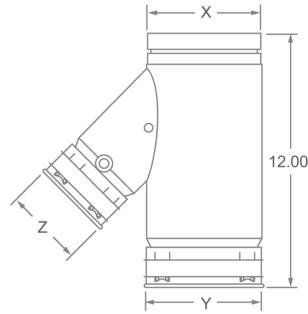

Model Number	Size X / Y / Z
4RYF33	4" / 3" / 3"
4RYF44	4" / 4" / 4"
4RYF43	4" / 4" / 3"
5RYF53	5" / 5" / 3"
5RYF54	5" / 5" / 4"
5RYF43	5" / 4" / 3"
5RYF44	5" / 4" / 4"
6RYF54	6" / 5" / 4"
6RYF53	6" / 5" / 3"
6RYF43	6" / 4" / 3"
6RYF44	6" / 4" / 4"
6RYF63	6" / 6" / 3"
6RYF64	6" / 6" / 4"

Draft Hood Connector - RDH*

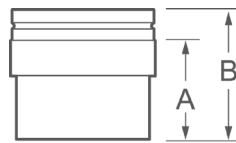

Model Number	Size	A	B
3RDH	3"	4 1/2"	6"
4RDH	4"	4 1/2"	6"
5RDH	5"	4 1/2"	6"
6RDH	6"	4 1/2"	6"
7RDH	7"	7"	8 1/2"
8RDH	8"	7"	8 1/2"
10RDH	10"	7"	8 1/2"
12RDH	12"	7"	8 1/2"

Rain Cap - RHW*

3" through 8"

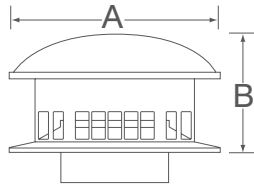

- Prevents rain and debris from entering the vent
- External screen prevents entry of birds

Model Number	Size	A	B
3RHW	3"	6"	3 ¼"
4RHW	4"	8"	4 ¼"
5RHW	5"	10"	5 ¼"
6RHW	6"	12"	6 ¼"
7RHW	7"	14"	7 ½"
8RHW	8"	16"	8 ½"

High Wind Cap - RWW*

3" through 6"

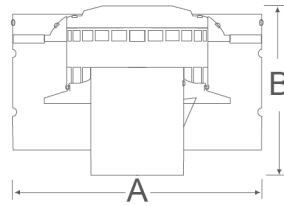

- Use in high wind environments

Model Number	Size	A	B
3RWW	3"	8"	5 ½"
4RWW	4"	10"	6"
5RWW	5"	12"	7"
6RWW	6"	14"	7 ½"

Universal Cap - CU*

10" through 30"

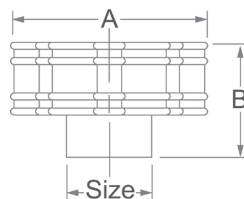

- Barriers provided in cap opening spaced less than 1" are designed to resist entry of birds
- Slips into most B-Vent

Model Number	Size	A	B
10CU	10"	15 ¾"	7 ½"
12CU	12"	19"	9"
14CU	14"	22"	11"
16CU	16"	25"	12"
18CU	18"	28 ¼"	13 ½"
20CU	20"	31 ½"	15"
22CU	22"	34 ½"	16 ½"
24CU	24"	37 ¾"	18"
26CU	26"	42"	19 ½"
28CU	28"	44"	21"
30CU	30"	48"	22 ½"

Metal Cap - C*

14" through 30"

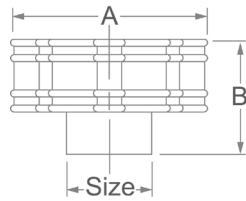

- Barriers provided in cap opening spaced less than 1" are designed to resist entry of birds
- Snap-locks onto pipe

Model Number	Size	A	B
14C	14"	22"	11"
16C	16"	25"	12"
18C	18"	28 1/4"	13 1/2"
20C	20"	31 1/2"	15"
22C	22"	34 1/2"	16 1/2"
24C	24"	37 3/4"	18"
26C	26"	42"	19 1/2"
28C	28"	44"	21"
30C	30"	48"	22 1/2"

Increaser - RN*



Model Number	Size	A	B
3RN4	3" to 4"	3 3/4"	5 1/4"
3RN5	3" to 5"	3 3/4"	5 1/4"
3RN6	3" to 6"	3 3/4"	5 1/4"
3RN7	3" to 7"	3 3/4"	5 1/4"
4RN5	4" to 5"	3 3/4"	5 1/4"
4RN6	4" to 6"	3 3/4"	5 1/4"
4RN7	4" to 7"	3 3/4"	5 1/4"
5RN6	5" to 6"	3 3/4"	5 1/4"
6RN7	6" to 7"	3 3/4"	5 1/4"
6RN8	6" to 8"	3 3/4"	5 1/4"
7RN8	7" to 8"	3 7/8"	5 3/8"
8RN10	8" to 10"	3 7/8"	5 3/8"
8RN12	8" to 12"	3 7/8"	5 3/8"
10RN12	10" to 12"	3 7/8"	5 3/8"

Universal Increaser/Adapter - RIX*



- Adapts and increases from locking ring style, small-diameter vent pipe to snap-lock large-diameter vent pipe

Model Number	Diameter Size
8RIX14U	8" to 14"
10RIX14U	10" to 14"
10RIX16U	10" to 16"
10RIX18U	10" to 18"
12RIX14U	12" to 14"
12RIX16U	12" to 16"
12RIX18U	12" to 18"
12RIX20U	12" to 20"

Increaser - RIX*



Model Number	Diameter Size	Model Number	Diameter Size
14RIX16	14" to 16"	22RIX24	22" to 24"
14RIX18	14" to 18"	18RIX26	18" to 26"
16RIX18	16" to 18"	20RIX26	20" to 26"
14RIX20	14" to 20"	22RIX26	22" to 26"
16RIX20	16" to 20"	24RIX26	24" to 26"
18RIX20	18" to 20"	20RIX28	20" to 28"
14RIX22	14" to 22"	22RIX28	22" to 28"
16RIX22	16" to 22"	24RIX28	24" to 28"
18RIX22	18" to 22"	26RIX28	26" to 28"
20RIX22	20" to 22"	22RIX30	22" to 30"
16RIX24	16" to 24"	24RIX30	24" to 30"
18RIX24	18" to 24"	26RIX30	26" to 30"
20RIX24	20" to 24"	28RIX30	28" to 30"

Female Adapter - RRA*

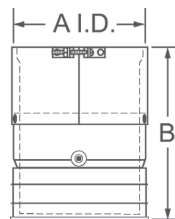

Model Number	Size	A. I.D.	B
3RRA	3"	3 3/4"	6"
4RRA	4"	4 3/4"	6"
5RRA	5"	5 3/4"	6"
6RRA	6"	6 3/4"	6"

- Adapts Hart & Cooley vent to other brands of B-Vent (ours to theirs)

Male Adapter - RAA*

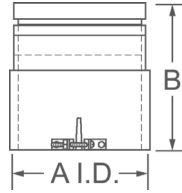

Model Number	Size	A I.D.	B
3RAA	3"	3 11/16"	6"
4RAA	4"	4 11/16"	6"
5RAA	5"	5 11/16"	6"
6RAA	6"	6 11/16"	6"
7RAA	7"	7 11/16"	8 1/2"
8RAA	8"	8 11/16"	8 1/2"

- Adapts thicker wall brands of B-Vent to Hart & Cooley vent (theirs to ours)

Male Adapter - RA*

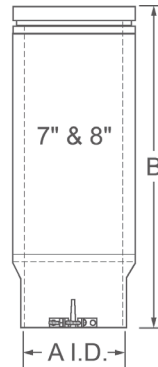
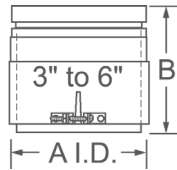

Model Number	Size	A I.D.	B Dim.
3RA	3"	3 9/16"	6"
4RA	4"	4 9/16"	6"
5RA	5"	5 9/16"	6"
6RA	6"	6 9/16"	6"
7RA	7"	7 9/16"	17 3/4"
8RA	8"	8 9/16"	17 3/4"

- Adapts other brands of B-Vent to Hart & Cooley vent (theirs to ours)

Competitive Manufacturer	Pipe Diameter	Airspace	Adapter Male	Model Female
Metalbestos	3" - 6"	1/4"	RA or RPA†	RRA
	7" - 8"	1/4"	RA	-
Metal Fab	3" - 6"	1/4"	RA or RPA†	RRA
	7" - 8"	1/2"	RPA	-
AmeriVent	3" - 6"	1/4"	RA or RPA†	RRA
	7" - 8"	1/2"	RPA	-
Air-Jet	3" - 6"	3/8"	RAA	-
	7" - 8"	3/8"	RAA	-
DuraVent	3" - 6"	5/16"	RAA	RRA
	7" - 8"	5/16"	RAA	-

†RPA, the Adjustable Length, can be found on page 6

Adjustable Roof Flashing - RF

Flat to 6/12

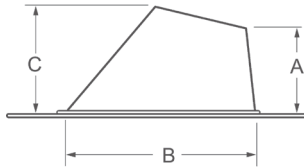
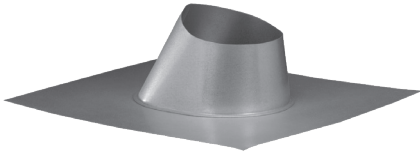

Model Number	Size	A	B	C
3RF	3"	3"	6 1/8"	4 1/8"
4RF	4"	3 1/4"	7 3/8"	4 1/8"
5RF	5"	3 1/2"	8 5/8"	4 3/4"
6RF	6"	3 3/4"	10"	5 1/4"
7RF	7"	4"	11 1/8"	6 3/8"
8RF	8"	4 1/4"	13 1/8"	6 3/4"
10RF	10"	4 3/4"	15 5/8"	7 1/2"
12RF	12"	4 3/4"	18"	8"
14RF	14"	5 1/4"	21"	9 1/4"
16RF	16"	5 1/4"	23 1/4"	9 1/2"
18RF	18"	5 3/4"	25 7/8"	10 1/2"
20RF	20"	5 3/4"	28 1/8"	11"
22RF	22"	6 1/4"	30 5/8"	12"
24RF	24"	6 1/4"	32 7/8"	12 1/2"
26RF	26"	NA	NA	12"
28RF	28"	NA	NA	12"
30RF	30"	NA	NA	13"

Adjustable Roof Flashing - RFA

6/12 to 12/12

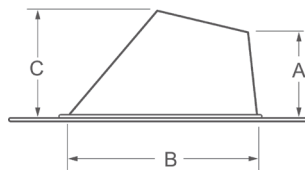
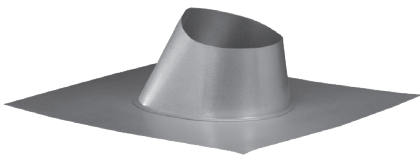

Model Number	Size	A	B	C
3RFA	3"	5 1/2"	6"	7 1/4"
4RFA	4"	5 3/8"	7 3/8"	7 9/16"
5RFA	5"	5 5/8"	8 5/8"	8 5/8"
6RFA	6"	5 3/8"	10"	8 13/16"
7RFA	7"	5 3/8"	11 7/8"	9 3/4"
8RFA	8"	5 1/4"	13"	10 1/16"

Tall Cone Roof Flashing - RTF

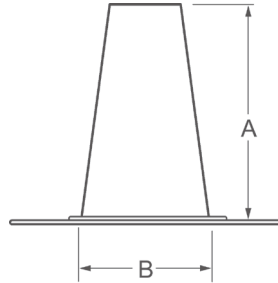

Model Number	Size	A	B
3RTF	3"	11"	7 1/2"
4RTF	4"	11"	7 1/2"
5RTF	5"	11"	7 1/2"
6RTF	6"	11"	7 1/2"
7RTF	7"	11"	11"
8RTF	8"	11"	11"
10RTF	10"	11"	16"
12RTF	12"	11"	16"
14RTF	14"	11"	19 1/4"
16RTF	16"	11"	19 1/4"
18RTF	18"	11"	23 5/8"
20RTF	20"	11"	23 5/8"
22RTF	22"	11"	27 5/8"
24RTF	24"	11"	27 5/8"
26FT	26"	11"	31 9/16"
28FT	28"	11"	31 9/16"
30FT	30"	11"	31 9/16"

Storm Collar - RS

3" through 6"

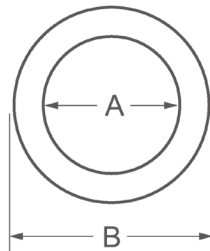

Model Number	Size	A	B
3RS	3"	3 1/2"	6 5/8"
4RS	4"	4 1/2"	7 5/8"
5RS	5"	5 1/2"	8 5/8"
6RS	6"	6 1/2"	9 5/8"

Adjustable Storm Collar - RS

7" through 12"

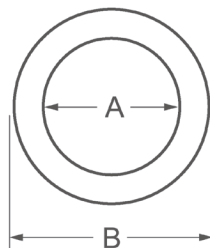

Model Number	Size	A	B
7RS	7"	8"	10 7/8"
8RS	8"	9"	11 7/8"
10RS	10"	11"	14 1/2"
12RS	12"	13"	16 1/2"

Adjustable Storm Collar - SC

14" through 30"

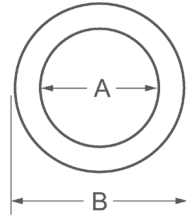

- Designed to be snug around vent pipe for a weather-tight fit
- For use with roof flashing and caulk

Model Number	Size	A	B
14SC	14"	15"	18 7/8"
16SC	16"	17"	21 1/4"
18SC	18"	19"	23 1/4"
20SC	20"	21"	25 15/16"
22SC	22"	23"	28 5/16"
24SC	24"	25"	30 11/16"
26SC	26"	27"	33 1/16"
28SC	28"	29"	35 1/16"
30SC	30"	31"	37 1/16"

Gripper Support - RGS*

3" through 10"

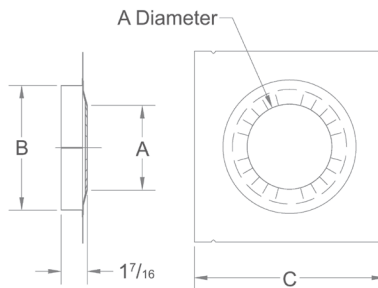
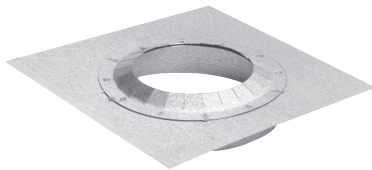

- Supports 30' of pipe
- Acts as a firestop
- 7", 8" and 10" not UL-listed

Model Number	Size	A	B	C
3RGS	3"	3 1/2"	5 1/2"	9"
4RGS	4"	4 1/2"	6 1/2"	10"
5RGS	5"	5 1/2"	7 1/2"	11"
6RGS	6"	6 1/2"	8 1/2"	12"
7RGS	7"	7 1/2"	-	13"
8RGS	8"	8 1/2"	-	14"
10RGS	10"	10 1/2"	-	16"

Firestop Support - FSP*

3" through 8"

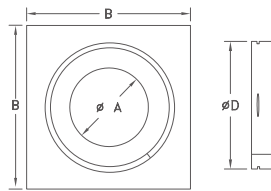
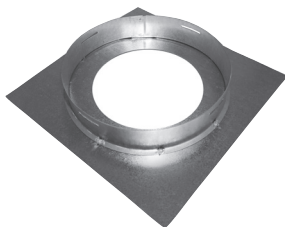

- Supports 20' of pipe
- Acts as a firestop

Model Number	Size	A	B	C	D
3FSP	3"	3 5/8"	7 1/2"	3 1/2"	5 1/2"
4FSP	4"	4 5/8"	8 1/2"	4 1/2"	6 1/2"
5FSP	5"	5 5/8"	9 1/2"	5 1/2"	7 1/2"
6FSP	6"	6 5/8"	10 1/2"	6 1/2"	8 1/2"
7FSP	7"	8 1/8"	12"	8"	10"
8FSP	8"	9 1/8"	13"	9"	11"

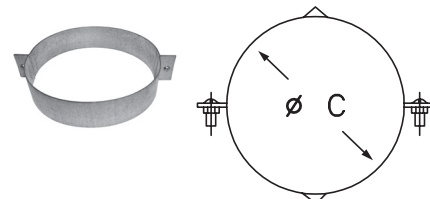

Support Plate - SP*

10" through 30"

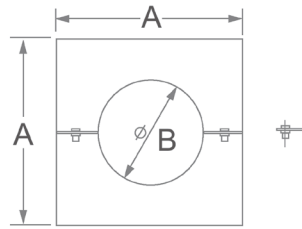
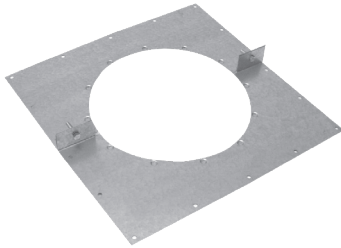

Model Number	Size	A	B
10SP	10"	18"	10 5/8"
12SP	12"	20"	12 5/8"
14SP	14"	22"	14 5/8"
16SP	16"	24"	16 5/8"
18SP	18"	26"	18 5/8"
20SP	20"	28"	20 5/8"
22SP	22"	30"	22 5/8"
24SP	24"	32"	24 5/8"
26SP	26"	34"	26 5/8"
28SP	28"	36"	28 5/8"
30SP	30"	38"	30 5/8"

- Supports 30' of pipe

Pipe Collar - RPC

3" through 8"

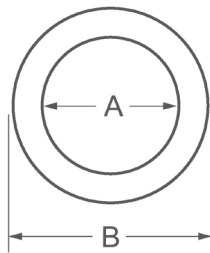
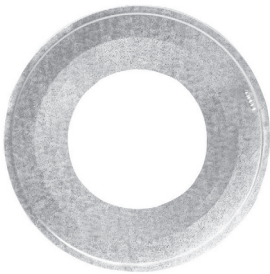

Model Number	Size	A	B
3RPC	3"	3 5/8"	8 3/4"
4RPC	4"	4 5/8"	8 3/4"
5RPC	5"	5 5/8"	10 7/8"
6RPC	6"	6 5/8"	12 7/8"
7RPC	7"	8 1/8"	14 7/8"
8RPC	8"	9 1/8"	16 7/8"

- To cover a rough opening

Wall Thimble - RWT

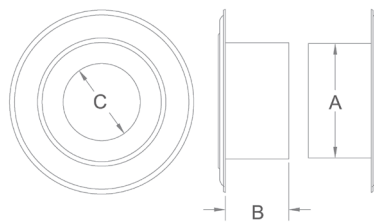

Model Number	Size	A	B	C
3RWT	3"	5 1/2"	3 1/16"	3 9/16"
4RWT	4"	6 1/2"	3 1/16"	4 9/16"
5RWT	5"	7 1/2"	3 1/16"	5 9/16"
6RWT	6"	8 1/2"	3 1/4"	6 9/16"
7RWT	7"	10"	3 1/4"	8 1/16"
8RWT	8"	11"	3 1/4"	9 1/16"

- Provides necessary clearance to combustibles
- Sleeve is adjustable from 3" to 6"

Wall Bracket - RWB



Model Number	Size	A	B	C
3RWB	3"	3"	3 1/2"	3 1/4"
4RWB	4"	4"	4 1/2"	3 3/4"
5RWB	5"	5"	5 1/2"	4 1/4"
6RWB	6"	6"	6 1/2"	4 3/4"
7RWB	7"	7"	8"	5 1/2"
8RWB	8"	8"	19 5/8"	6 5/8"
10RWB	10"	10"	21 11/16"	7 13/16"
12RWB	12"	12"	23 3/4"	9"

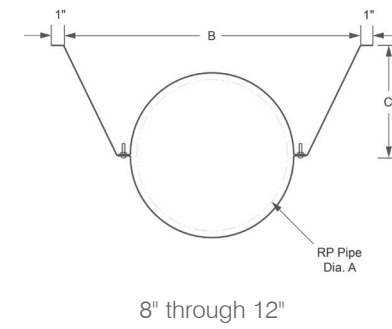
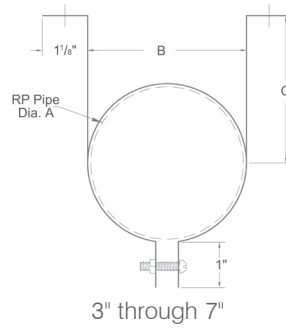

- Available in 3" through 12"
- 8" through 12" bracket used with perforated pipe strap supplied by others

Single-Wall Flexible Gas Vent Connector - SFC

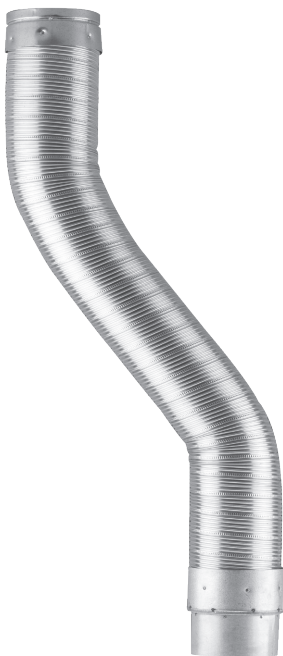

- Single-wall flexible construction
- Includes an integral appliance draft hood connector for fast installation
- Locks onto Hart & Cooley type-B gas vent
- Requires 1" clearance to combustibles per installation instructions
- UL-listed for use as a connection from an appliance to type-B gas vent in conditioned spaces only
- Do not enclose
- Available in 3" through 5" diameters and 1' through 5' lengths

Diameter	Model Number	Length
3"	3SFC12	12"
	3SFC24	24"
	3SFC3	36"
	3SFC4	48"
	3SFC5	60"
4"	4SFC12	12"
	4SFC24	24"
	4SFC3	36"
	4SFC4	48"
	4SFC5	60"
5"	5SFC12	12"
	5SFC24	24"
	5SFC3	36"
	5SFC4	48"
	5SFC5	60"

Double-Wall Flexible Gas Vent Segment - DFC



- Features double-wall, air-insulated construction
- Has type-B male/female ends for easy connection with Hart & Cooley B-Vent
- Requires 1" clearance to combustibles
- UL-listed for use as a connection from an appliance to type-B gas vent and as a segment of type-B gas vent
- Can be used in unconditioned spaces, such as attics and crawl spaces
- Do not enclose
- Available in 3" through 5" diameters and 2' through 5' lengths

Diameter	Model Number	Length
3"	3DFC24	24"
	3DFC3	36"
	3DFC4	48"
	3DFC5	60"
4"	4DFC24	24"
	4DFC3	36"
	4DFC4	48"
	4DFC5	60"
5"	5DFC24	24"
	5DFC3	36"
	5DFC4	48"
	5DFC5	60"

Type B Oval Gas Vent Pipe & Fittings

Oval Pipe - OP

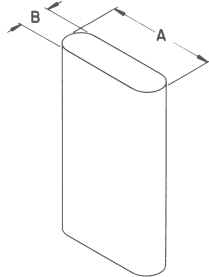

Type B

Sizes 4" and 5" may be installed with 1" minimum clearance to combustibles.

Type BW (recessed heater)

4" oval vent (when installed in 2 x 4 stud wall with recessed heater) requires clearances as determined by use of 4OBPWS hold-down plate, 4OCP ceiling plate spacers, and 4OFS firestop spacers.

Type B 2x4

4" and 5" oval vent (when installed in 2 x 4 stud wall, not using a recessed heater) requires clearance as determined by use of 4OFS or 5OFS firestop spacers at each ceiling level.

Model Number	Size	A	B
4OP6	4"	7 1/16"	2 7/8"
4OP12	4"	7 1/16"	2 7/8"
4OP18	4"	7 1/16"	2 7/8"
4OP24	4"	7 1/16"	2 7/8"
4OP3	4"	7 1/16"	2 7/8"
4OP4	4"	7 1/16"	2 7/8"
4OP5	4"	7 1/16"	2 7/8"
5OP18	5"	10 3/4"	2 7/8"
5OP24	5"	10 3/4"	2 7/8"
5OP3	5"	10 3/4"	2 7/8"
5OP4	5"	10 3/4"	2 7/8"
5OP5	5"	10 3/4"	2 7/8"

- Oval Pipe overlaps 1 3/8" when joined together; therefore, assembled length is 1 3/8" less than listed length.
- Offers all the advantages of round pipe, and may be used for the following types of installation.

4" Oval:

Conventional Type B

Type B-2x4 when used with firestop

Type BW-2x4 with recessed heater

5" Oval:

Type B

Type B-2x4

Adjustable Oval Pipe - OPA



Sizes for 12" Lengths:

4", 5" (adjustable from 3" to 10")

Model Number	Size
4OPA	4"
5OPA	5"

- Telescopes onto oval pipe sections
- Adjusts from 3" to 10"

Standard Elbow - OES45

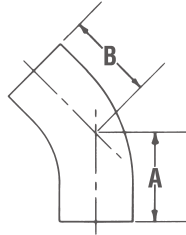

Model Number	Size	A	B
4OES45	4"	3"	3"
5OES45	5"	3 1/2"	3 1/2"

- Used in pairs where offsets are desired in 1" minimum clearance enclosures or open spaces, such as attics or basements
- Add pipe sections between pairs to produce additional offset

Flat Elbow - OEF45

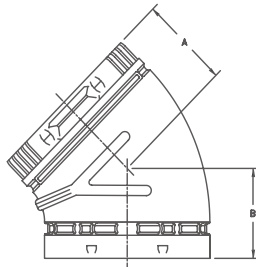

Model Number	Size	A	B
4OEF45	4"	3 3/4"	3 3/4"
5OEF45	5"	4 3/4"	4 3/4"

- Used in pairs where offsets are desired in 1" minimum clearance enclosures or open spaces, such as attics or basements
- Add pipe sections between pairs to produce additional offset

Standard Oval Tee - OT

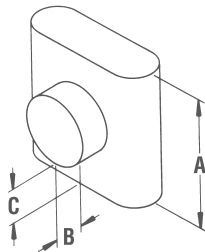

Model Number	Size	A	B	C
4OT	4"	12"	2 9/16"	2 3/8"
5OT	5"	12"	2 9/16"	2 3/8"

- The branch size and trunk size have the same diameter
- The tee branch accepts either double-wall or single-wall pipe

Tee Support - OBC

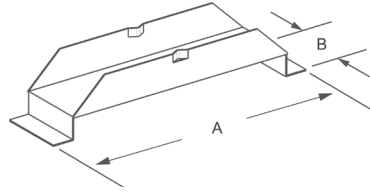

Model Number	Size	A	B
4OBC	4"	3"	11 1/2"
5OBC	5"	3"	12 7/8"

- Supports and centers the tee
- Use with the tee cap shown below

Oval Tee Cap - OTC

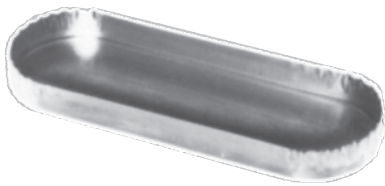

Model Number	Size
4OTC	4"
5OTC	5"

- Used to close off the bottom of the tee

Oval-to-Round Adapter - OAR*

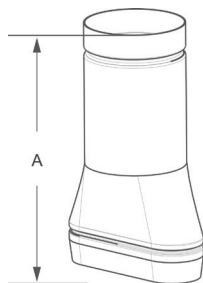

Model Number	Size	A Dim.
4OAR	4"	11 3/8"

- Adapts from oval to lock-ring style round B-Vent

Oval-to-Round Adapter - OARA

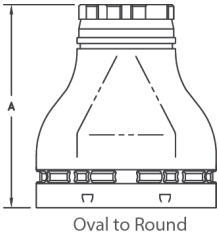

Model Number	Size	A
4OARA	4"	6 7/8"
5OA5RA	5"	9 3/8"

- Used for conversion of vent from oval to round
- Requires use of RAA male adapter to continue with round

Round-to-Oval Adapter - RAO

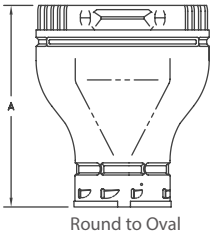

Model Number	Size	A
4RAO	4"	6 7/8"
5RA5O	5"	9 3/8"

- Used for conversion of vent from round to oval
- Requires use of RRA female adapter to come from round

Plate Spacers - OCP

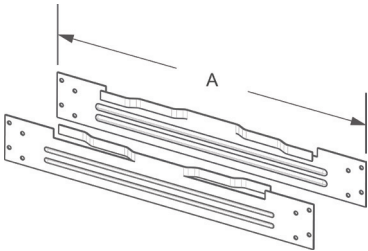
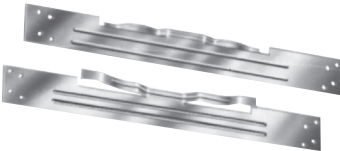

Model Number	Size	A
4OCP	4"	17 1/2"

- Required at the first ceiling level above a wall furnace to center and space vent properly and to provide the required opening between floors
- Firestop spacers must be used at subsequent levels

Hold-Down Plate - OBPWS

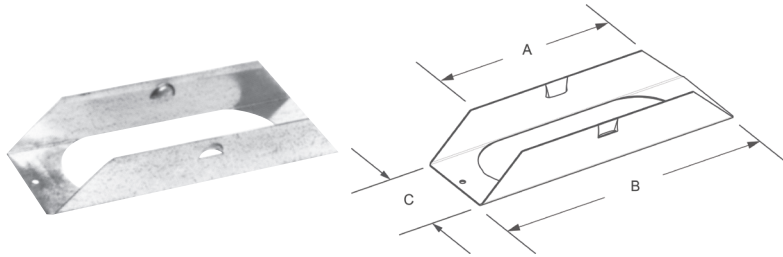

Model Number	Size	A	B	C
4OBPWS	4"	6 1/2"	9 5/8"	2 3/16"

- Required for connecting Type-BW vent to a wall furnace outlet

Firestop Spacers - OFS

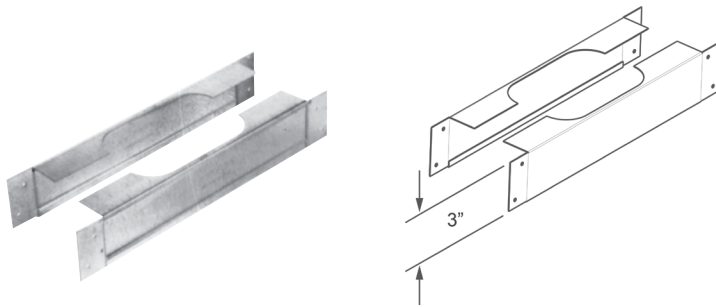

Model Number	Size	Wall
4OFS	4"	2" x 4"
5OFS	5"	2" x 4"
4OFS6	4"	2" x 6"

- Centers oval vent in 16" O.C. stud space
- Serves as a firestop at the ceiling level
- Required component for Type-B 2 x 4 and multi-story Type-BW installations

Oval Cap - OC

4"



Model Number	Size	A	B
OC	4"	5 3/8" x 8 1/2"	3 1/2"

Cap - ECW

5"

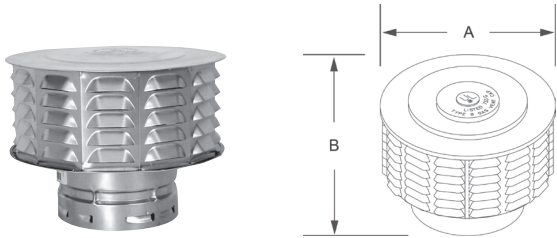

Model Number	Size	A	B
5ECW	5"	9 7/8"	5 5/16"

- Use with 5" Oval to Round Adapter, 50A5RA

Oval Flashing - OF

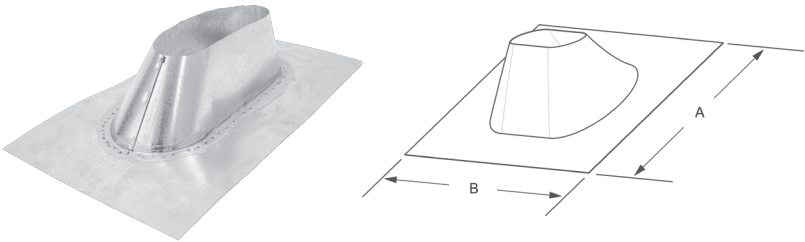

Model Number	Size	A	B
4OF	4"	17 7/8"	13 1/2"
5OF	5"	23"	14"

- Installed either parallel or perpendicular to the roof ridge
- Fits roof pitches flat to 5/12

Oval Storm Collar - OSC



Model Number	Size
4OSC	4"
5OSC	5"

- Serves as a counter flashing and requires mastic to seal to the vent pipe

Type B Gas Vent Installations

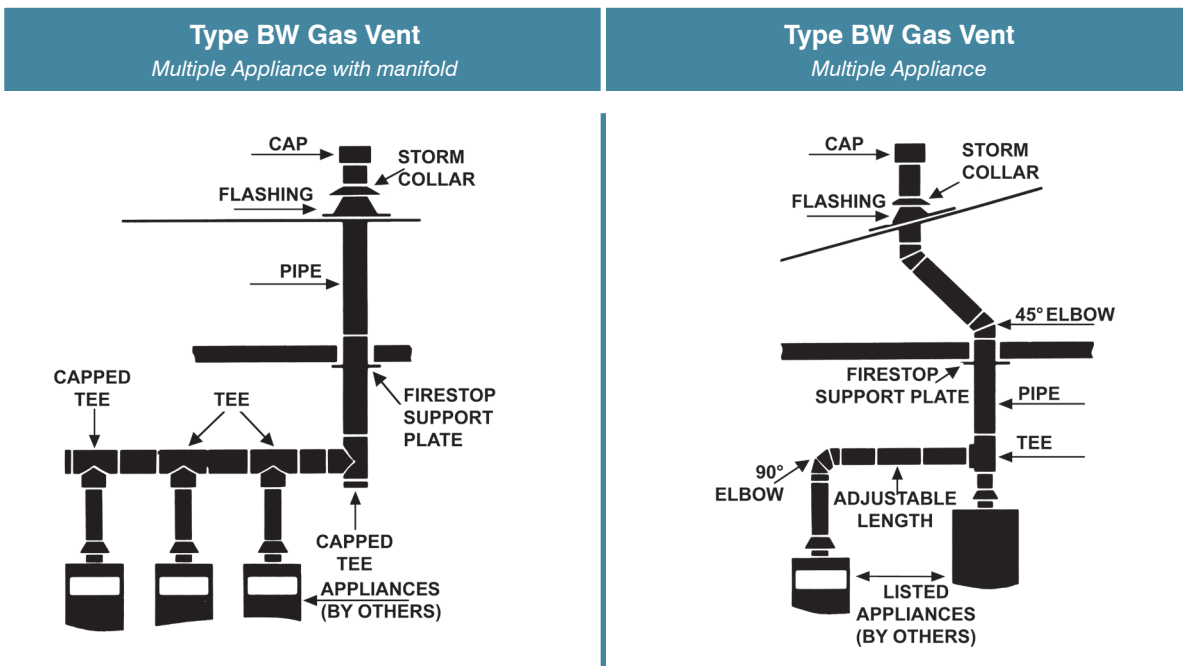
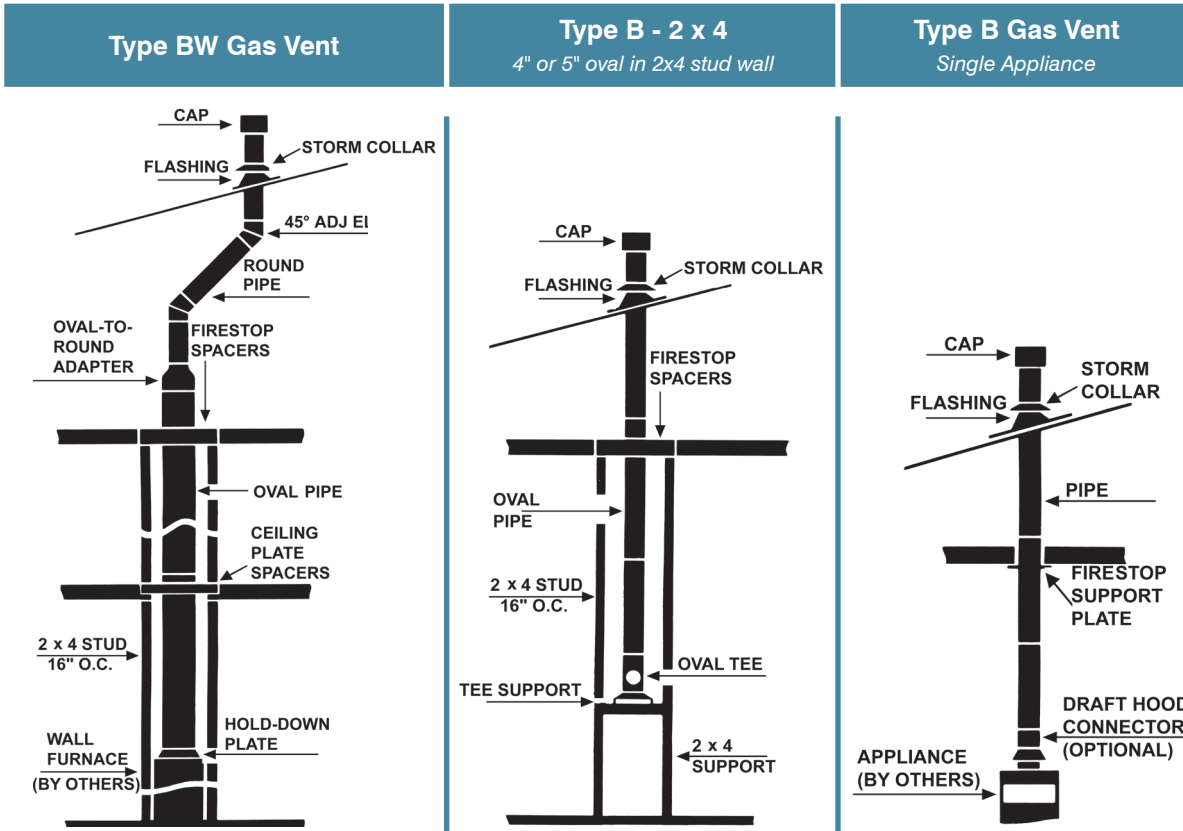

Gas Appliance Chimney Liner Systems

Basic Kit - ALK



- Available in 3", 4", 5", 5.5", 6", 7" and 8" diameters
- Available in 15', 25' and 35' lengths
- Listed to: UL1777 and ULC-S635
- Compatible with type-B gas vent systems
- Kit includes length, round top, flashing with 3" collar, mortar guard, fasteners and instructions

Model Number	Size	Length
3ALK15	3"	15'
3ALK25	3"	25'
3ALK35	3"	35'
4ALK15	4"	15'
4ALK25	4"	25'
4ALK35	4"	35'
5ALK15	5"	15'
5ALK25	5"	25'
5ALK35	5"	35'
55ALK25	5 ½"	25'
55ALK35	5 ½"	35'
6ALK25	6"	25'
6ALK35	6"	35'
7ALK25	7"	25'
7ALK35	7"	35'
8ALK25	8"	25'
8ALK35	8"	35'

Extension Kit - ALKE



- 10' flexible liner length
- Includes coupler and fastener package
- UL-listed

Model Number	Size	Length
3ALKE10	3"	10'
4ALKE10	4"	10'
5ALKE10	5"	10'
55ALKE10	5 ½"	10'
6ALKE10	6"	10'
7ALKE10	7"	10'
8ALKE10	8"	10'

Insulated Sleeve - ALK-FS



Model Number	Size
4ALK-FS	3" - 4"
5ALK-FS	5"
6ALK-FS	5 1/2" - 6"
7ALK-FS	7"
8ALK-FS	8"

- Insulation sleeve with tough poly exterior
- Cable ties included

Flex Coupler - ALK-FC

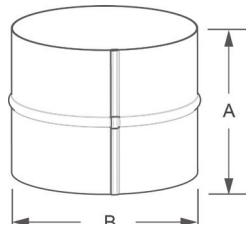

Model Number	Size	A	B
3ALK-FC	3"	4"	2.97"
4ALK-FC	4"	4"	3.97"
5ALK-FC	5"	4"	4.97"
55ALK-FC	5 1/2"	4"	5.47"
6ALK-FC	6"	4"	5.97"
7ALK-FC	7"	4"	6.97"
8ALK-FC	8"	4"	7.97"

- For fitting or joining ALK liner lengths

Pull Down - FX-PD

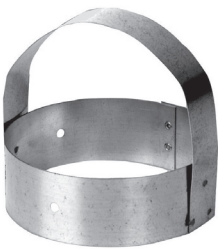

Model Number	Size
3FX-PD	3"
4FX-PD	4"
5FX-PD	5"
55FX-PD	5 1/2"
6FX-PD	6"
7FX-PD	7"
8FX-PD	8"

- Used to stretch and lead ALK liner down chimney

Adapters - ALK-VA

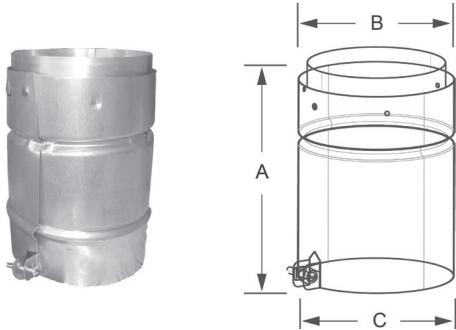

Model Number	Size	A	B	C
3ALK-VA	3"	5.88"	2.95"	3.57"
4ALK-VA	4"	5.88"	3.95"	4.57"
5ALK-VA	5"	5.88"	4.95"	5.57"
6ALK-VA	6"	5.88"	5.95"	6.57"
7ALK-VA	7"	5.88"	6.95"	8.57"
8ALK-VA	8"	5.88"	7.95"	9.57"

- Adapter to transition from all brands of listed type-B Gas Vent to ALK Liner

Female B-Vent Adapter - RLA



Model Number	Size	A	B
3RLA	3"	3"	5 ⁵ / ₈ "
4RLA	4"	4"	5 ⁵ / ₈ "
5RLA	5"	5"	5 ⁵ / ₈ "
6RLA	6"	6"	5 ⁵ / ₈ "
7RLA	7"	7"	5 ⁵ / ₈ "
8RLA	8"	8"	5 ⁵ / ₈ "

- Sold separately; not part of kit



Hart & Cooley, Inc.
5030 Corporate Exchange Blvd. SE
Grand Rapids, MI 49512

P (800) 433-6341
F (800) 223-8461

hartandcooley.com



GRILLES | REGISTERS | DIFFUSERS | FLEXIBLE AIR DUCT
VENT | CHIMNEY | ACCESS DOOR | FILTERS | DUCT COMPONENTS