



# U Match

## CEILING CASSETTE

### OWNER'S MANUAL

---

#### *Models:*

#### ***Indoor Unit***

*UMAT18HP230V1AC*

*UMAT24HP230V1AC*

*UMAT30HP230V1AC*

*UMAT36HP230V1AC*

*UMAT42HP230V1AC*

*UMAT48HP230V1AC*

#### ***Outdoor Unit***

*UMAT18HP230V1AO*

*UMAT24HP230V1AO*

*UMAT30HP230V1AO*

*UMAT36HP230V1AO*

*UMAT42HP230V1AO*

*UMAT48HP230V1AO*



# **Thank you for choosing a U-Match Ceiling Cassette Air Conditioning & Heating System!**

*You can feel confident in your selection because the same pride in craftsmanship and engineering knowledge that goes into millions of other Gree installed products worldwide has gone into your unit.*

*Please read this owner's manual carefully before operation and retain it for future reference.*

## **Table of Contents**

<i>Introduction</i> .....	2
<i>Nomenclature</i> .....	3
<i>Safety Precautions</i> .....	4
<i>System Components</i> .....	5
<i>System Functions</i> .....	6-8
<i>Wireless Remote Controller</i> .....	9-14
<i>Care and Cleaning</i> .....	15-16
<i>Troubleshooting</i> .....	17-18
<i>Diagnostic Codes</i> .....	19-20
<i>Energy Saving Tips</i> .....	21
<i>Warranty</i> .....	Back

# **INTRODUCTION**

---

## ***Superior Design for Superior Performance***

*Gree's discreet U-Match Ceiling Cassette provides low-noise performance through design and innovation. The Ceiling Cassette is a one-stop solution for heating and air conditioning large and small rooms. This flexible climate solution conveniently disappears above the surface of any room's drop ceiling. Features include a highly effective inverter driven variable speed compressor, 4-way air discharge, multi speed fan, swing louver and a cleanable air filter.*

*Gree's cutting edge fan technology is quiet and powerful. It efficiently circulates the conditioned air throughout the space while safely removing water via the internal condensate drain pump.*

*Flexibility and innovation make the Ceiling Cassette the best choice for creating ideal climate conditions.*

# NOMENCLATURE

## Indoor unit

Example: UMAT18HP230V1AC

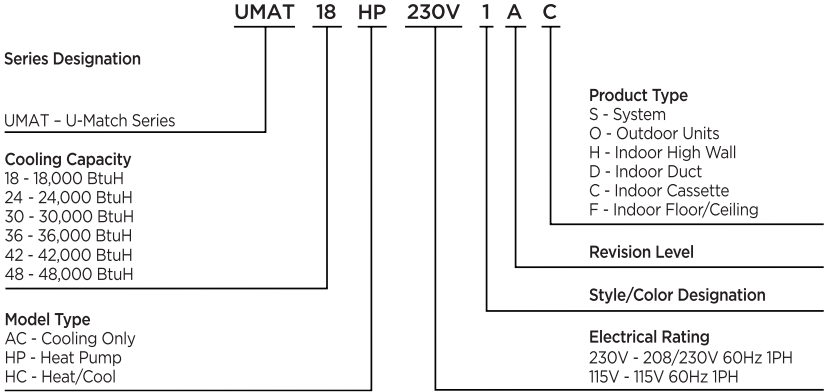

## Outdoor unit

Example: UMAT18HP230V1AO

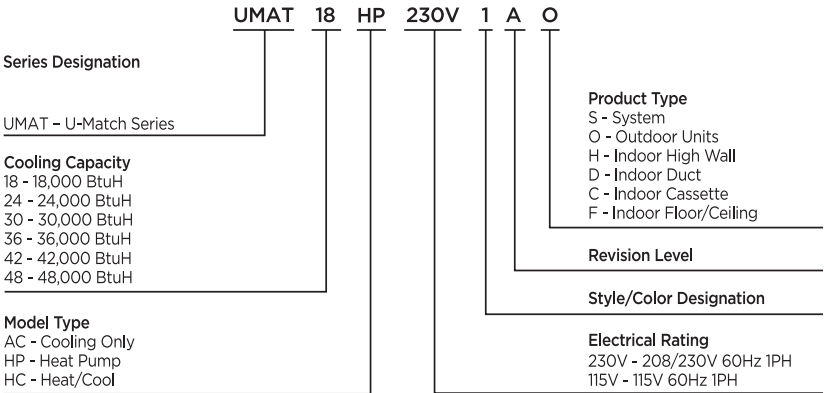

## SAFETY PRECAUTIONS

---

### **Please read the following before operation.**

Recognize safety information.  This is the safety-alert symbol. When you see this symbol on the unit and in instructions or manuals, be alert to the potential for personal injury. Understand these signal words: **DANGER**, **WARNING**, and **CAUTION**. These words are used with the safety-alert symbol.

**DANGER** identifies the most serious hazards which will result in severe personal injury or death.

**WARNING** signifies hazards which could result in personal injury or death.

**CAUTION** is used to identify unsafe practices which may result in minor personal injury or product and property damage.

**NOTE** is used to highlight suggestions which will result in enhanced installation, reliability, or operation.

**NOTE:** Your actual air conditioning & heating system and related devices may differ from the images shown in this manual.

### **WARNING**

This appliance is not intended for use by children without responsible adult supervision. Proper care should be taken to ensure safety.

### **WARNING**

Heat pumps, air conditioners & heating equipment should be installed, started up, and serviced only by qualified installers and service technicians. Air conditioning, heat pumps and refrigeration systems are hazardous due to high voltage electrical components, high refrigerant pressures, and moving parts.

### **WARNING**

- Disconnect electrical power to the indoor and outdoor units before performing any maintenance or cleaning.
- Do not attempt to repair the Gree system yourself. Incorrect repairs may cause electric shock or fire. Contact a qualified service technician for all service requirements.
- Keep combustible materials away from the unit.

### **CAUTION**

- Do not put hands or any objects into the air inlets or outlets. This may cause personal injury or damage the unit.
- When cleaning, be careful not to splash water on the unit. Doing this may cause electric shock or damage to unit.
- In the event of a failure (burning smell, etc.), immediately disconnect all electrical power to indoor and outdoor units.

# SYSTEM SCHEMATIC

## Indoor unit

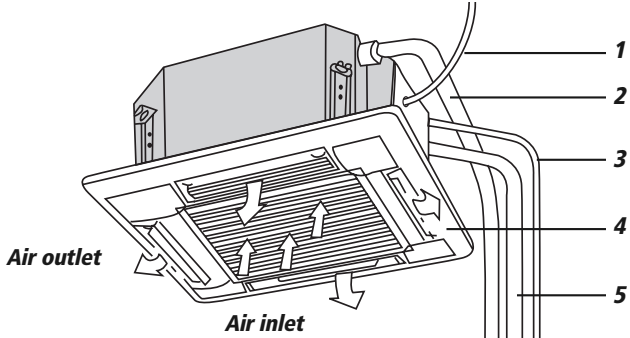

## System Components\*

1. Indoor Power Supply
2. Drain Pipe
3. Communication Cable
4. Decorative Discharge Air Grille (sold separately)
5. Refrigeration Pipes
6. Wired Tether Controller (sold separately)
7. Remote Controller
8. Service Cover
9. Communication Cable
10. Front Panel
11. Outdoor Power Supply
12. Liquid Pipe
13. Gas Pipe
14. Drain Hose

\* Not all items included in equipment purchase

## Outdoor Unit

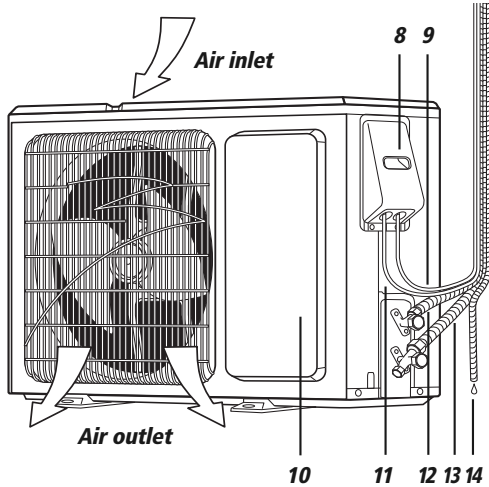

### CAUTION

The refrigerant pipe, drain pipe and electrical wiring for this unit should be installed by a qualified HVAC professional only.

## **SYSTEM FUNCTIONS**

---

### **WHISPER QUIET**

*Not only are the Gree systems energy efficient but they are quiet too. Ceiling Cassette operates with sound levels starting as low as 37 dB(A).*

### **MULTI FAN SPEEDS**

*Whether operating in either Cooling or Heating mode, the indoor fan can be set to your choice of three different speeds (Low, Medium or High) to achieve maximum comfort.*

### **BUILT IN CONDENSATE LIFT PUMP**

*The unit features a built-in drain pump that lifts condensate up to 39 inches above the drain pan to a gravity condensate drain system. In most cases, the internal condensate lift mechanism will avoid the need for an external condensate pump.*

### **CONDENSATE SENTRY**

*The unit's fail-safe mechanism recognizes when there is a high level in the condensate pan and shuts off the system to prevent overflow.*

### **INTELLIGENT PRE-HEATING**

*U-Match Systems guards against the annoying cool air blown into the room in heating mode. The system constantly monitors the discharge air temperature. It will delay the indoor fan until the indoor coil has warmed up to prevent blowing uncomfortable cool air into the room.*

### **CONTROLLERS**

*The Ceiling Cassette unit comes with a factory supplied Wireless Remote Controller. An optional Wired Tether Controller is sold separately.*

**NOTE:** *The controllers are mutually exclusive. They cannot be used at the same time.*

### **WIRELESS REMOTE**

*The Gree multi-functional infrared hand held wireless controller is sleek, ergonomically designed, easy to use and has a large backlit LCD display.*

### **TETHER CONTROLLER**

*The Gree wired Tether Controller mounts to the wall up to 25 feet from the unit. It provides complete control over your unit's operation mode, desired temperature, fan speed, airflow direction and more. (Sold Separately)*

# SYSTEM FUNCTIONS

---

## **INTELLIGENT DEFROST**

*The Intelligent Defrost function increases room comfort and saves energy by eliminating unnecessary defrost cycles. In heating mode, the unit will monitor the outdoor coil for frost buildup. Once frost buildup has been detected, the system will switch into a defrost mode to remove the frost.*

## **I FEEL MODE**

*The unit will sense room temperature at the remote controller instead of at the indoor unit. It then adjusts airflow and temperature accordingly for the ultimate in personal comfort control and energy savings. This function is only available with the wired Tether Controller. (Sold Separately)*

## **SWING LOUVER**

*The adjustable swing louvers can be controlled from the wireless controller. Vertical swing louvers allows five different air discharge directions including Continuous Sweep. Maximize comfort by adjusting the direction of airflow in the room by moving the louvers up or down.*

## **FRESH AIR INTAKE**

*The Ceiling Cassette has a ventilation air knockout that allows a 4-inch flex duct connection and a field-supplied duct booster fan. The maximum fresh air allowed is 20% of the unit's high-speed fan airflow rating.*

## **POWER FAILURE MODE**

*Power interruptions are no problem for the U-Match system. User selections and system parameters are stored in non-volatile memory. These parameters are retained during a power failure. When power is returned, the Ceiling Cassette system will automatically return to the last operating mode.*

## **TURBO MODE**

*Use Turbo Mode for situations where you wish to achieve the desired room temperature in the shortest possible time. This mode runs the unit at ultra high speeds for quickest results.*

## **CLOCK**

*The wireless remote controller has a built-in clock feature. The remote will display the time of day in a 24-hour format.*

## **TIMER MODE**

*The unit can be programmed to turn ON or OFF after a specific amount of time. The time period is adjustable between one half and 24 hours.*



# SYSTEM FUNCTIONS

---

## **MODE BUTTON**

The unit can be set to five different operating modes: HEAT, COOL, DRY, FAN ONLY and AUTO.

**NOTE:** AUTO MODE has fixed setpoints of 68° F heating and 77° F cooling, which are not adjustable. The system will automatically select heating or cooling to maintain room temperature within this band.

## **SLEEP MODE**

The unit will automatically adjust room temperature during your sleep time. This slight change in temperature will not affect your comfort level due to the natural effects that sleeping has on the body, but it will save on energy consumption and will lower electric bills.

## **X-FAN MODE**

When operating in humid areas, the X-fan or Dry Coil function allows the indoor fan to run for a pre-determined amount of time after the unit is turned off (cooling or dry modes) to ensure that additional moisture is removed from coil.

## **FAHRENHEIT °F / CELSIUS °C**

The remote controller can be set to display in either °F or °C.

## **SELF-DIAGNOSIS**

With an on-board computer using real-time diagnostics, the Gree U-Match system helps to prolong its own life. The automatic diagnosis feature continuously scans for unacceptable operating conditions or malfunctions. If such conditions occur, the system takes corrective action or stops. Error codes are shown on the unit display to facilitate easy troubleshooting and repair.

## **PRIVACY LOCK MODE**

The wireless remote controller has a Privacy Lock. The Privacy Lock averts unauthorized access or tampering with system settings.

## **AGENCY LISTINGS**

All systems are listed with AHRI (Air conditioning, Heating, and Refrigeration Institute) and are ETL certified per UL Standards.

# OPERATION OF WIRELESS REMOTE CONTROLLER

## Remote Controller

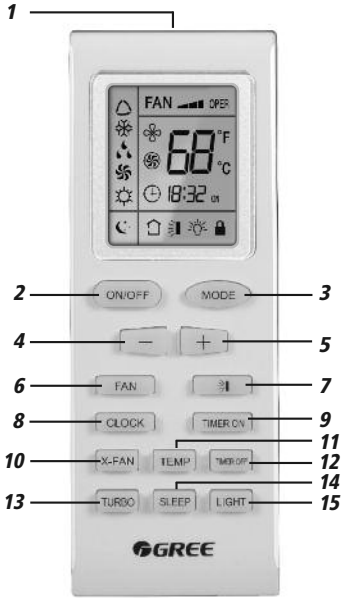

### Part Name

- 1 Signal Transmitter
- 2 ON/OFF Button
- 3 Mode Button
- 4 - Button
- 5 + Button
- 6 Fan Button
- 7 Swing Button
- 8 Clock Button
- 9 Timer ON Button
- 10 X-Fan Button
- 11 Temp Button
- 12 Timer OFF Button
- 13 Turbo Button
- 14 Sleep Button
- 15 Light Button

## INTRODUCTION FOR ICONS ON DISPLAY SCREEN

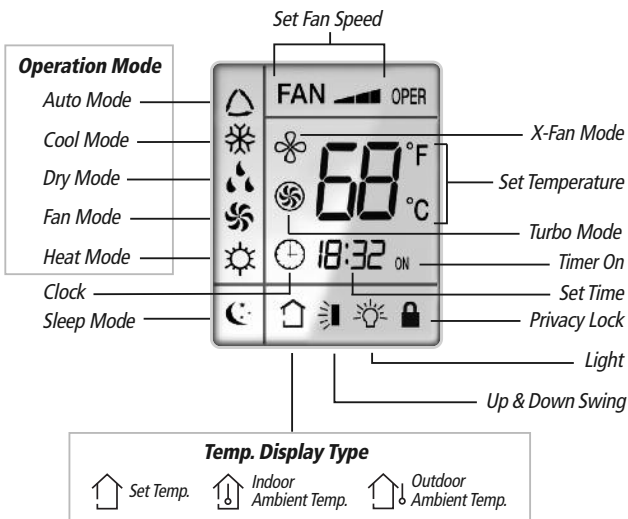

# OPERATION OF WIRELESS REMOTE CONTROLLER

## REMOTE CONTROLLER OPERATIONS

The wireless remote controller is sleek, versatile and allows you to change room temperatures and functions on your U-Match Ceiling Cassette system from the palm of your hand. The large LCD display and buttons make it easy-to-understand and easy-to-use.

The remote controller is set from factory to display temperatures in °F. If °C is desired, turn the remote **OFF** and then press "**MODE**" and "**—**" buttons on the remote simultaneously.

The wireless remote controller is the interface between the user and the Gree cassette system. Commands are entered by the user to control the system. Any command that has been entered with the remote controller will remain in memory until it is changed by the user or the batteries are replaced.

When entering commands, point the remote controller in the direction of the unit. The unit will emit an audible beep when the signals are received correctly.

### ON/OFF BUTTON

When you press the **ON/OFF** button, "**OPER**" icon will be displayed and the unit will start in the last operating mode and room setpoint. When you press the **ON/OFF** button again, the "**OPER**" icon will disappear and the unit will shut down. The remote controller will display the time and last room setpoint.

**NOTE:** If the **ON/OFF** button is pressed too soon after a stop, the compressor will not start for 3 minutes due to the inherent protection against frequent compressor cycling.



ON Mode Display

### SWING LOUVERS

Press the Swing Louver button to select five different vertical (up & down) air discharge directions including Continuous Sweep. The Swing Louver  icon will be displayed. Press this button to set swing angle, which changes in direction as below:

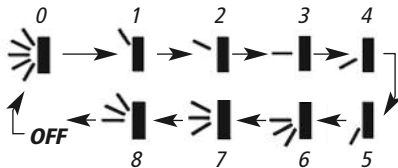

Swing Louver Display

 Indicates louver swings back and forth in the five directions, as shown.

# OPERATION OF WIRELESS REMOTE CONTROLLER

## MODE BUTTON

Use the “**MODE**” button to select one of the available modes. The selected mode will be displayed on the remote controller and the appropriate icon will be displayed.

**AUTO** – Unit will automatically select heating or cooling to maintain room temperature between 68°F and 77°F. The remote controller will display the Auto Mode icon with no setpoint. The front panel display will show “77.”

**COOL** – To cool to selected setpoint and remove moisture. System varies compressor speed to maintain desired temperature.

**HEAT** – To heat to selected room setpoint. System varies compressor speed to maintain desired room temperature.

**FAN ONLY** – To circulate air without heating or cooling. Use Fan Speed button to select speed from low to high.

**DRY** – Select **DRY MODE** to increase moisture removal during warm humid conditions. In Dry mode the indoor fan will run at low speed during the cooling cycle. When setpoint is reached, the indoor fan will turn off with the compressor.

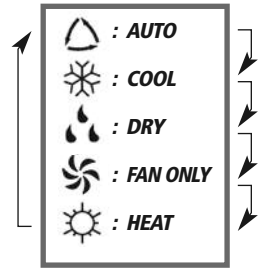

Icons Displayed

## FAN BUTTON

By pressing this button, AUTO, LOW (▲), MEDIUM (▲▲), or HIGH (▲▲▲), speeds can be circularly selected. AUTO is the default fan speed after Power ON.



Fan Button

**NOTE:** In DRY mode, fan speed is not adjustable, it will remain at LOW.

## LIGHT BUTTON

Press the LIGHT button to turn On or Off the display on the ceiling cassette. When the indoor unit first powers on, the ceiling cassette display will default to ON. The LIGHT icon will display when the front panel display is ON.



Light Display

# OPERATION OF WIRELESS REMOTE CONTROLLER

## TIMER ON MODE

The Ceiling Cassette unit can be programmed to automatically turn **ON** after a selected time period. With the unit in **OFF** mode, press **TIMER** button to activate the **TIMER** mode, and the **ON/OFF** icon will begin blinking. Press + or - button to select a time setting from 0.5 to 24 hours. Press once for slow adjustment and hold down for fast adjustment. Press **TIMER** button to confirm settings, and icon will stop blinking. The unit will turn **ON** after the selected time period.

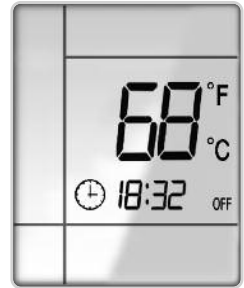

Timer ON

## TIMER OFF MODE

The Ceiling Cassette unit can be programmed to automatically turn **OFF** after a selected time period. With the unit in **ON** mode, press **TIMER** button to activate the **TIMER** mode, and the **ON/OFF** icon will begin blinking. Press + or - button to select a time setting from 0.5 to 24 hours. Press once for slow adjustment and hold down for fast adjustment. Press **TIMER** button to confirm settings, and icon will stop blinking. The unit will turn **OFF** after the selected time period.

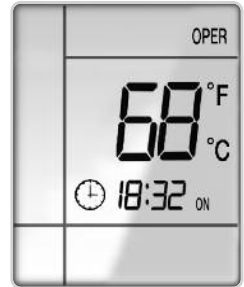

Timer OFF

## TEMP BUTTON

When the "**TEMP**" button is pushed once, the temperature indicator  is displayed. This indicates that the setpoint temperature is displayed.

When the "**TEMP**" button is pushed a second time, the display will show an  icon with a thermometer inside a house. This indicates that the room temperature is displayed.

When the "**TEMP**" button is pushed a third time, the display will show an  icon with a thermometer outside a house. This indicates that the outdoor temperature is displayed. (Not available on some models).

The room temperature and outdoor temperature will be displayed for only 5 seconds before reverting back to displaying room setpoint.



Temp Button

## PRIVACY LOCK MODE

The Privacy Lock prevents unauthorized access to the unit controls and prevents tampering with system settings. The remote controller can be locked by pushing the "+" and "-" buttons simultaneously for 2 seconds. The Privacy Lock icon will be displayed on the remote controller. Repeat the process to unlock the remote controller.



Privacy Lock Display

# OPERATION OF WIRELESS REMOTE CONTROLLER

## X-FAN MODE

When operating in humid areas, the unit has a DRY COIL function called X-Fan that will allow the indoor fan to run for a pre-determined amount of time after the unit is turned off (cooling or dry modes) to ensure that additional moisture is removed from coil. Push the "X-FAN" button to enable this feature. The **X-FAN**  icon will be displayed on remote controller. To deactivate this feature, push the "X-FAN" button again.



X-Fan Mode Display

## SLEEP MODE

The unit will automatically adjust room temperature during your sleep time. This slight change in temperature will not affect your comfort level due to the natural effects that sleeping has on the body, but it will save on energy consumption and will lower your electric bill. Press the SLEEP button to select Sleep Mode. The SLEEP  icon will appear.

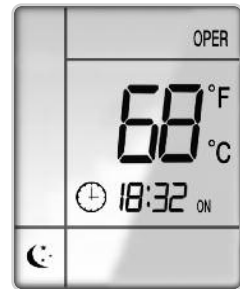

Sleep Mode Display

### In Cool or Dry modes:

If setpoint is between 61°F to 73°F, temperature will slowly increase 2°F per hour for 3 hours, then maintain this setpoint for 4 hours, then reduce setpoint by 2°F and hold at this setpoint until Sleep Mode is cancelled.

If setpoint is between 74°F to 81°F, temperature will slowly increase 2°F per hour for 2 hours, then maintain this setpoint for 5 hours, then reduce setpoint by 2°F and hold at this setpoint until Sleep Mode is cancelled.

If setpoint is between 82°F to 85°F, temperature will slowly increase 2°F per hour for 1 hour, then maintain this setpoint for 6 hours, then reduce setpoint by 2°F and hold at this setpoint until Sleep Mode is cancelled.

If setpoint is 86°F, unit will run at this setpoint for 7 hours, then reduce setpoint by 2°F and hold at this setpoint until Sleep Mode is cancelled.

### In Heat mode:

If setpoint is between 82°F to 86°F, the unit will slowly reduce setpoint by 2°F per hour for 3 hours, and then maintain this setpoint until Sleep Mode is cancelled.

If setpoint is between 69°F to 81°F, the unit will slowly reduce setpoint by 2°F per hour for 2 hours, and then maintain this setpoint until Sleep Mode is cancelled.

If setpoint is between 63°F to 68°F, the unit will reduce setpoint by 2°F, and then maintain this setpoint until Sleep Mode is cancelled.

If setpoint is 62°F, the unit will run at this setpoint until Sleep Mode is cancelled.

# OPERATION OF WIRELESS REMOTE CONTROLLER

## CLOCK BUTTON

Press the **CLOCK** button to enter Clock Setup Mode. The clock icon will begin flashing. Set the clock by pressing the + or - buttons. Press once for slow adjustment; press and hold down for fast adjustment. When finished, press the **CLOCK** button to save your clock settings. This is the current time, not the timer setting.

**NOTE:** Clock time adopts 24-hour mode. A 12-hour format is not available.



Clock Display

## TURBO MODE

The desired room setpoint can be achieved faster in **TURBO** mode. After selecting the "HEAT" or "COOL" mode button, push the "TURBO" button. The **TURBO** icon will be displayed on the remote controller and the unit will run at an ultra-high speed. To deactivate the feature, push the "TURBO" button again. The unit will return to normal operation.



Turbo Mode Display

## CHANGING BATTERIES AND ADDITIONAL NOTES

To change batteries, slide cover off battery compartment on back of remote controller. Remove and safely discard old batteries. Insert two new AAA 1.5V dry batteries, using correct polarity. Reattach back cover.

### NOTE:

- If the remote controller will not be used for a long time, remove batteries to prevent leakage damage.
- Be sure to aim the remote controller at the receiver of the main unit when operating.
- When remote emits a signal, icon will flicker; a tone will be heard when unit receives that signal.

## CHANGING BATTERIES

Remove old batteries

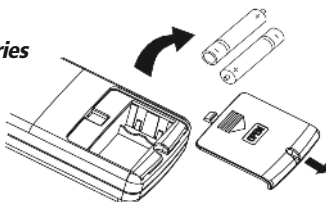

Install new batteries

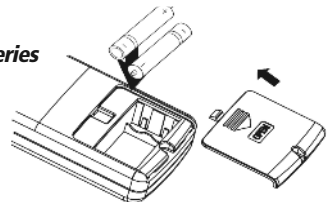

# CARE AND CLEANING

Routine maintenance consists of checking the condensate drain for clogs, hosing off the outdoor coil of outdoor unit and cleaning the air filter and the indoor decorative grille.

## **WARNING**

Turn off power and disconnect from indoor and outdoor units before cleaning. Failure to do so could cause electric shock.

### **DECORATIVE GRILLE CLEANING**

Wash the decorative grille using warm water and mild detergent with a soft cloth or soft brush.

**NOTE:** Do not use bleach, abrasives or water above 110°F (45°C) as it may cause discoloration or damage to the surface of the unit.

### **AIR FILTER CLEANING**

Changing your air filter on a regular basis prevents many problems. Dirty air filters will affect the performance and the longevity of your unit. It is recommended that air filters be cleaned every three (3) months.

### **HOW TO REMOVE AIR FILTER**

**For the 24-42K cassette unit:**

1. Push the latch as shown in the figure
2. Release the screws under clasps by a screwdriver.
3. Release the fastener and open the panel grille.

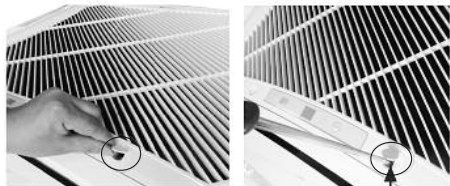

Remove the screw



Push the fastener



# CARE AND CLEANING

## **For the 18 and 48K cassette unit:**

1. Remove screws with a screwdriver as shown.
2. Release the two fasteners and open the panel grille.

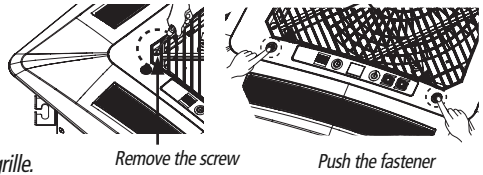

## **Disassemble the air inlet grille:**

1. Open the air inlet grille at 45°, lift up and remove the grille.
2. Disassemble the filter screen and remove it from the filter door.

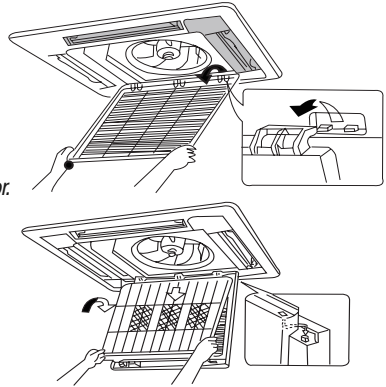

## **HOW TO CLEAN AIR FILTER**

1. Clean dust, lint and dirt from the air filter using a vacuum cleaner or washing with water. If dirt is conspicuous, wash with a mild detergent in lukewarm water. After washing air filter with water, let dry in the shade. Do not expose the air filter to direct sunlight or direct heat to dry.
2. Reinsert the air filter into filter door, careful to align properly.
3. Close secure filter door.

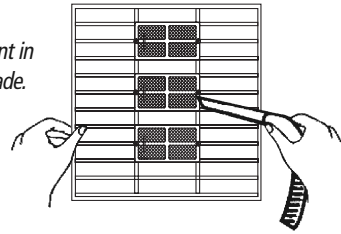

## **Re-install grille assembly**



# TROUBLESHOOTING

PROBLEM	CAUSE/SOLUTION
System does not restart.	<p><b>Cause:</b> The system has a built-in three-minute delay to prevent short and/or rapid cycling of the compressor.</p> <p><b>Solution:</b> Wait three minutes for the protection delay to expire.</p>
Indoor unit emits unpleasant odor when started	<p><b>Cause:</b> Typically unpleasant odors are the result of mold or mildew forming on the coil surfaces or the air filter.</p> <p><b>Solution:</b> Wash indoor air filter in warm water with mild cleaner. If odors persist, contact a qualified service professional to clean the coil surfaces.</p>
You hear a “water flowing” sound.	<p><b>Cause:</b> It is normal for the system to make “water flowing” or “gurgling” sounds from refrigerant pressures equalizing when the compressor starts and stops</p> <p><b>Solution:</b> The noises should discontinue as the refrigerant system equalizes after two or three minutes.</p>
A thin fog or vapor coming out of the indoor unit when system is running.	<p><b>Cause:</b> It is normal for the system to emit a slight fog or water vapor when cooling extremely humid warm air.</p> <p><b>Solution:</b> The fog or water vapor will disappear as the system cools and dehumidifies the room space.</p>
You hear a slight cracking sound when the system stops or starts.	<p><b>Cause:</b> It is normal for the system to make “slight cracking” sounds from parts expanding and contracting during system starts and stops.</p> <p><b>Solution:</b> The noises will discontinue as temperature equalizes after 2 or 3 minutes.</p>
The system will not run.	<p><b>Cause:</b> There are a number of situations that will prevent the system from running.</p> <p><b>Solution:</b> Check for the following:</p> <ul style="list-style-type: none"> <li>• Circuit breaker is “tripped” or “turned off.”</li> <li>• Power button of remote is not turned on.</li> <li>• Batteries in the remote controller are low.</li> <li>• Remote controller is in sleep mode or timer mode.</li> <li>• Otherwise, contact a qualified service professional for assistance.</li> </ul>
The unit is not heating or cooling adequately.	<p><b>Cause:</b> There are a number of reasons for inadequate cooling or heating.</p> <p><b>Solution:</b> Check the following:</p> <ul style="list-style-type: none"> <li>• Remove obstructions blocking airflow into the room.</li> <li>• Clean dirty or blocked air filter that is restricting airflow into the system.</li> <li>• Seal around door or windows to prevent air infiltration into the room.</li> <li>• Relocate (if possible) other heat sources from the room.</li> </ul>
Water leakage from the outdoor unit.	<p><b>Cause:</b> It is normal for the outdoor unit to generate condensate water in the reverse cycle heating and defrost mode.</p> <p><b>Solution:</b> This is normal. No action is required.</p>

# TROUBLESHOOTING

PROBLEM	CAUSE/SOLUTION
Water leaking from the indoor unit into the room.	<p><b>Cause:</b> While it is normal for the system to generate condensate water in cooling mode, it is designed to drain this water via a condensate drain system to a safe location.</p> <p><b>Solution:</b> If water is leaking into the room, it may indicate one of the following.</p> <ul style="list-style-type: none"><li>• The indoor unit is not level right to left. Level indoor unit.</li><li>• The condensate drain pipe is restricted or plugged. All restrictions must be removed to allow continuous drainage by gravity.</li><li>• If problem persists, contact a qualified service professional for assistance.</li></ul>
Wireless remote controller does not work.	<p><b>Cause:</b> There are a number of possible reasons</p> <p><b>Solution:</b> Check the following:</p> <ul style="list-style-type: none"><li>• The batteries might be low. Change the batteries.</li><li>• The remote controller must be within 25 ft. (7.5 m) with no obstructions of the indoor unit. If remote controller needs to be replaced, contact a qualified service professional for assistance. In the meantime, use the optional Wired Tether Controller, if available.</li></ul>
The unit will not deliver air.	<p><b>Cause:</b> There are a number of system functions that will prevent air flow.</p> <p><b>Solution:</b> Check for the following:</p> <ul style="list-style-type: none"><li>• In heat mode, the indoor fan may not start for three minutes if the room temperature is very low. This is to prevent blowing cold air.</li><li>• In heat mode, if the outdoor temperature is low and humidity is high, the system may need to defrost for up to 10 minutes before beginning a heating cycle.</li><li>• In dry mode, the indoor fan may stop for up to three minutes during the compressor off delay.</li><li>• Otherwise, you should contact a qualified service professional for assistance.</li></ul>
Moisture or condensation on the discharge air louvers or outlet vents.	<p><b>Cause:</b> It is normal for the system to develop condensation or moisture on the discharge air louvers when cooling warm humid air for a long period of time.</p> <p><b>Solution:</b> The condensation or moisture will disappear as the system cools and dehumidifies the room space.</p>



## CAUTION

### Stop operation and call for service in the following circumstances:

- You hear a harsh or unusual sound during operation.
- Unusually foul odor is emitted during operation.
- Water is leaking in the room.
- You notice a burning smell or see smoke.
- Circuit breaker trips frequently, or unit stops abnormally often.

## DIAGNOSTIC CODES

The U-Match System has on board diagnostics. The indoor unit and Tether Controller will display error codes. The following is a summary of the codes with explanation:

### Error Codes

No.	Error Code	Malfunction Name	Origin of Malfunction	Description
1	E1	High Pressure Protection	High Pressure Switch	If outdoor unit detects the high pressure switch is cut off for 3-sec successively, high pressure protection will occur. All the loads (except the 4-way valve in heating mode) will be switched off. In this case, all the buttons and remote control signals except ON/OFF button will be disabled and system won't be recovered automatically. Switch off the unit or re-energize the unit after cutting off power to eliminate this protection.
2	E2	Indoor Coil Freeze Protection	Indoor Evaporator Temperature Sensor	If indoor unit detects the evaporator temperature is lower than protective temperate value after the unit has been running for a period of time under cooling or dry mode, the unit will report this fault, in which case the compressor and outdoor fan motor will be stopped. The unit will not run until evaporator temperature is higher than the protective temp. value and the compressor is stopped for 3-min.
3	E4	Compressor High Discharge Temperature Protection	Compressor Discharge Temperature	If outdoor unit detects the discharge temperature is higher than protective temperature value, the unit will report high discharge temperature protection. If the protection occurs over 6 times, the unit cannot be recovered automatically. Switch off the unit or re-energize the unit after cutting off power to reset this protection.
4	E6	Communication Malfunction	Comm. Failure Between Indoor and Outdoor Main Board	If the outdoor unit does not receive data from indoor unit, communication malfunction will be reported. If there is communication abnormality between display board and indoor unit, communication malfunction will be reported.
5	E8	Low Indoor Airflow	Indoor Fan Motor	If the indoor unit does not receive signal from indoor fan motor for 30-sec successively when the fan motor is operating, indoor fan motor malfunction will be reported. In this case, the unit can automatically resume operation after stopping. If the malfunction occurs 6 times within one hour, the unit cannot be recovered automatically. Switch off the unit or re-energize the unit after cutting off power to eliminate this malfunction.
6	E9	Condensate Overflow Protection	Overflow Switch	If indoor unit detects the condensate overflow switch warning for 8-sec successively, the system will enter condensate overflow protection. The unit will shut off and will not recover automatically. Switch unit off and then switch it on to eliminate this malfunction.
7	F0	Indoor Ambient Temperature Sensor at Return Air Inlet Malfunction	Indoor Ambient Temperature Sensor	If indoor unit detects the indoor ambient temperature sensor is open circuit or short circuit for 5-sec successively, indoor ambient temp. sensor malfunction will be reported. The unit can automatically resume operation after the malfunction disappears. If indoor ambient temperature sensor malfunction occurs in fan mode, only the error code is displayed and the indoor unit will operate normally.
8	F1	Indoor Evaporator Coil Temperature Sensor Malfunction	Evaporator Coil Temperature Sensor	If indoor unit detects the evaporator temperature sensor is open circuit or short circuit for 5-sec successively, evaporator temperature sensor malfunction will be reported. The unit can automatically resume operation after the malfunction disappears. If evaporator temperature sensor malfunction occurs in fan mode, only the error code is displayed and the indoor unit will operate normally.

# DIAGNOSTIC CODES

## Error Codes

No.	Error Code	Malfunction Name	Origin of Malfunction	Description
9	F2	Indoor Condenser Coil Temperature Sensor Malfunction	Condenser Coil Temperature Sensor	If outdoor unit detects the condenser coil temperature sensor open circuit or short circuit for 5-sec successively, condenser coil temperature sensor malfunction will be reported. The unit can automatically resume operation after the malfunction disappears. If condenser temperature sensor malfunction occurs in fan mode, only the error code is displayed and the indoor unit will operate normally.
10	F3	Outdoor Ambient Temperature Sensor Malfunction	Outdoor Ambient Temperature Sensor	If outdoor unit detects the outdoor ambient temperature sensor open circuit or short circuit for 5-sec successively, outdoor ambient temperature sensor malfunction will be reported. The unit can automatically resume operation after the malfunction disappears. If outdoor ambient temperature sensor malfunction occurs in fan mode, only the error code is displayed and the indoor unit will operate normally.
11	F4	Compressor Discharge Temperature Sensor Malfunction	Compressor Discharge Temperature Sensor	If outdoor unit detects the compressor discharge temperature sensor is open circuit or short circuit for 5-sec successively after the compressor has been operating for 3-min, outdoor discharge temperature sensor malfunction will be reported. The unit can automatically resume operation after the malfunction disappears.
12	F5	Wired Controller Temp. Sensor Malfunction	Wired Tether Controller Temp. Sensor	If the wired Tether Controller detects open circuit or short circuit of its temperature sensor for 5-sec successively, wired controller temperature sensor malfunction will be reported.
13	H1	Defrost Mode	No Failure	System is defrosting outdoor coil.
14	H3	Compressor Overload Protection	Compressor Overload Switch	If outdoor unit detects the compressor overload switch open within 3-sec successively, the unit will report compressor overload protection. If the fault occurs successively 3 times, the unit will not recover automatically. Switch off the unit or re-energize the unit to eliminate this protection.
15	H4	Overload Protection	Evaporator Temperature, Condenser Temperature	If indoor unit detects the evaporator coil temperature is higher than protective temp. value, the unit will report overload protection. The unit will restart operation after evaporator temperature is lower than the protective temp. value and the compressor is stopped for 3-minutes. If the protection occurs over 6 times, the unit will not recover automatically. Switch off the unit or re-energize the unit to eliminate this protection.
16	H6	Outdoor Fan Motor Malfunction	Outdoor Fan Motor	If outdoor unit does not receive feedback signal from outdoor fan motor for 30-sec successively when the fan motor is operating, an outdoor fan motor malfunction will be reported. In this case, the unit can automatically resume operation after stopping. If the malfunction occurs 6 times within one hour, the unit will not recover automatically. Switch off the unit or re-energize the unit to eliminate this malfunction.
17	U7	Reversing or 4-way Valve Malfunction	Reversing/ 4-way Valve	After the compressor starts operation in heating mode, if the outdoor unit detects the difference between evaporator temperature and indoor ambient temperature is lower than the protective value for 10-min successively, Reversing Valve Malfunction will be reported and the outdoor unit will stop operation. If the malfunction occurs 3 times, the unit will not recover automatically. Switch off the unit or re-energize the unit to eliminate this malfunction.

## ENERGY SAVING TIPS

---

- 1. Relaxing room temperature at night is OK:** During the nighttime hours you don't require the same level of conscious cooling or heating. Try using Sleep Mode to gradually relax room temperature and allow the unit to run less and save energy.
- 2. Curtains and shades:** In the summer, you need to block the effects of the sun. Close window curtains and shades on the south and west side of your home to help block solar heat. In winter, the sun is your friend. Open curtains and shades to allow solar heat into your room.
- 3. Close doors:** If you don't need to heat and cool your whole home, confine the heating and cooling to one room by closing doors. Limit the space you're heating and cooling to specified capability of the unit.
- 4. Service the unit:** Some basic maintenance might be all you need. The outdoor unit will greatly benefit from a good hosing out, especially in treed areas where seeds and other debris can stick to coil fins and make the unit work up to 15% harder!
- 5. Rearrange the room:** Furniture that obstructs airflow means you could be heating and cooling the back of a chair or the front of a sofa instead of the actual living space. Remove or rearrange obstacles blocking airflow.
- 6. Try 75 degrees:** 75°F is a good point for an air conditioner to run at its optimal performance level. Even a 5-degree change in temperature can make your unit use up to 40% more energy!
- 7. Lighting:** Turning lights off can help reduce your heat. Each light bulb is a tiny heater. Your air conditioner must waste energy overcoming the heat from your lights to reach and hold your desired room temperature.
- 8. Is anyone home?** If possible, while you're away turn your unit to Auto mode and make sure windows and drapes are closed. Although room temperature may be less than optimal for a few minutes when you come home, the unit will soon have the room back to your desired temperature.
- 9. Don't forget the fan:** The fan is much like a car. The faster it runs, the more energy it uses. Sometimes we need the car to go fast, but slow is good enough most of the time. Try saving money by using the comfortable quiet low fan speed as much as possible.



**GREE ELECTRIC APPLIANCES, INC.**

[www.greecomfort.com](http://www.greecomfort.com)



## LIMITED WARRANTY

GREE distributor (hereinafter "Company") warrants this product against failure due to defect in materials or workmanship under normal use and maintenance as follows. All warranty periods begin on the date of original installation. If the date cannot be verified, the warranty period begins one hundred twenty (120) days from date of manufacture. If a part fails due to defect during the applicable warranty period Company will provide a new or remanufactured part, at Company's option, to replace the failed defective part at no charge for the part. This limited warranty is subject to all provisions, conditions, limitations and exclusions listed below.

- Seven (7) years on compressor and Five (5) years on all parts to the original registered end-user.
- One (1) year warranty on remote controller unit.
- Proper installation – Limited warranty applies only to systems that are installed by a state certified or licensed HVAC contractor, under applicable local and state law in accordance with all applicable building codes and permits; GREE installation and operation instructions and good trade practices.
- Warranty applies only to products remaining in their original installation location.
- Defective parts must be returned to the distributor through a registered servicing dealer for credit.

**LIMITATIONS OF WARRANTIES:** ALL IMPLIED WARRANTIES AND/OR CONDITIONS (INCLUDING IMPLIED WARRANTIES OR CONDITIONS OF MERCHANTABILITY AND FITNESS FOR A PARTICULAR USE OR PURPOSE) ARE LIMITED TO THE DURATION OF THIS LIMITED WARRANTY, SOME STATES OR PROVINCES DO NOT ALLOW LIMITATIONS ON HOW LONG AN IMPLIED WARRANTY OR CONDITION LASTS, SO THE ABOVE MAY NOT APPLY TO YOU. THE EXPRESS WARRANTIES MADE IN THIS WARRANTY ARE EXCLUSIVE AND MAY NOT BE ALTERED, ENLARGED, OR CHANGED BY ANY DISTRIBUTOR, DEALER, OR OTHER PERSON, WHATSOEVER.

### THIS WARRANTY DOES NOT COVER:

1. Labor or other costs incurred for diagnosing, repairing, removing, installing, shipping, servicing or handling of either defective parts, or replacement parts, or new units.
2. Normal maintenance as outlined in the installation and servicing instructions or Owner's Manual, including filter cleaning and/or replacement and lubrication.
3. Failure, damage or repairs due to faulty installation, misapplication, abuse, improper servicing, unauthorized alteration or improper operation.
4. Failure to start due to voltage conditions, blown fuses, open circuit breakers, or damages due to the inadequacy or interruption of electrical service.
5. Failure or damage due to floods, winds, fires, lightning, accidents, corrosive environments (rust, etc.) or other conditions beyond the control of the Company.
6. Parts not supplied or designated by Company, or damages resulting from their use.
7. Products installed outside USA and Canada.
8. Electricity or fuel costs, or increases in electricity or fuel costs from any reason whatsoever, including additional or unusual use of supplemental electric heat.
9. Any cost to replace, refill or dispose of refrigerant, including the cost of refrigerant.
10. Any special, indirect or consequential property or commercial damage of any nature whatsoever. Some states or provinces do not allow the exclusion of incidental or consequential damages, so the above limitation may not apply to you.

For additional warranty exclusions, visit [www.GreeComfort.com](http://www.GreeComfort.com).

This warranty gives you specific legal rights, and you may also have other rights which vary from state to state or province to province.

For warranty service or repair, contact your installing contractor. You may find the installer's name on the equipment or in your Owner's packet.

Complete product registration below and send back by e-mail at [service@twclimate.com](mailto:service@twclimate.com)

### PRODUCT REGISTRATION

Model No. \_\_\_\_\_

Serial No. \_\_\_\_\_ Date of Installation \_\_\_\_\_

Owner Name \_\_\_\_\_

Address of Installation \_\_\_\_\_

Installing Contractor \_\_\_\_\_

Address \_\_\_\_\_

Phone No. / E-mail \_\_\_\_\_