



MULTI **CEILING CASSETTE** **OWNER'S MANUAL**

Models:

CAS12HP230V1AC

CAS18HP230V1AC

CAS24HP230V1AC



Thank you for choosing a Multi21 Ceiling Cassette Air Conditioning & Heating System!

You can feel confident in your selection because the same pride in craftsmanship and engineering knowledge that goes into millions of other Gree installed products worldwide has gone into your unit.

Please read this owner's manual carefully before operation and retain it for future reference.

Table of Contents

<i>Introduction</i>	<i>2</i>
<i>Nomenclature</i>	<i>3</i>
<i>Safety Precautions</i>	<i>4</i>
<i>System Parts</i>	<i>5</i>
<i>System Functions</i>	<i>6-8</i>
<i>Wireless Remote Controller</i>	<i>9-15</i>
<i>Wired Tether Controller</i>	<i>16-24</i>
<i>Care and Cleaning</i>	<i>25-26</i>
<i>Troubleshooting</i>	<i>27-28</i>
<i>Diagnostic Codes</i>	<i>29-32</i>
<i>Energy Saving Tips</i>	<i>33</i>
<i>Warranty</i>	<i>Back</i>

INTRODUCTION

Superior Design for Superior Performance

Gree's discreet Multi21 Ceiling Cassette provides low-noise performance through design and innovation. The Ceiling Cassette is a one-stop solution for heating and air conditioning large and small rooms. This flexible climate solution conveniently disappears above the surface of any room's drop ceiling. Features include a highly effective inverter driven variable speed compressor, 4-way air discharge, multi speed fan, swing louver and a cleanable air filter.

Gree's cutting edge fan technology is quiet and powerful. It efficiently circulates the conditioned air throughout the space while safely removing water via the internal condensate drain pump.

Flexibility and innovation make the Ceiling Cassette the best choice for creating ideal climate conditions.

NOMENCLATURE

Example: CAS18HP230V1A C

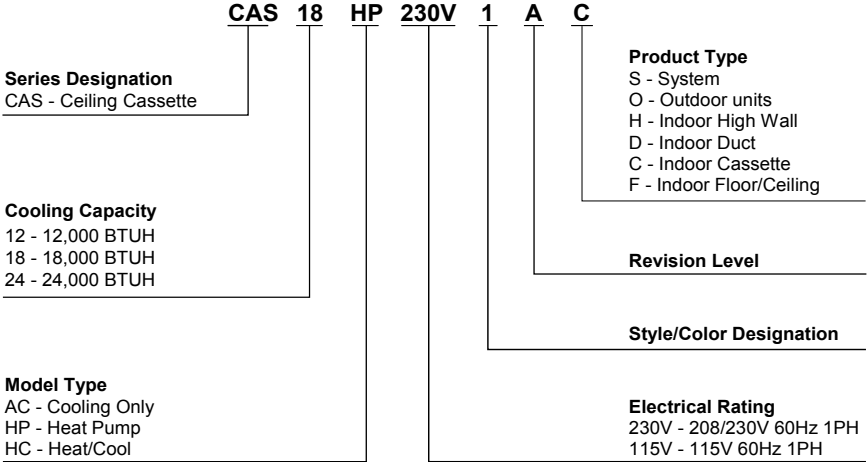

SAFETY PRECAUTIONS

Please read the following before operation.

Recognize safety information.  This is the safety-alert symbol. When you see this symbol on the unit and in instructions or manuals, be alert to the potential for personal injury. Understand these signal words: **DANGER**, **WARNING**, and **CAUTION**. These words are used with the safety-alert symbol.

DANGER identifies the most serious hazards which will result in severe personal injury or death.

WARNING signifies hazards which could result in personal injury or death.

CAUTION is used to identify unsafe practices which may result in minor personal injury or product and property damage.

NOTE is used to highlight suggestions which will result in enhanced installation, reliability, or operation.

NOTE: Your actual air conditioning & heating system and related devices may differ from the images shown in this manual.

WARNING

This appliance is not intended for use by children without responsible adult supervision. Proper care should be taken to ensure safety.

WARNING

Heat pumps, air conditioners & heating equipment should be installed, started up, and serviced only by qualified installers and service technicians. Air conditioning, heat pumps and refrigeration systems are hazardous due to high voltage electrical components, high refrigerant pressures, and moving parts.

WARNING

- Disconnect electrical power to the indoor and outdoor units before performing any maintenance or cleaning.
- Do not attempt to repair the Gree system yourself. Incorrect repairs may cause electric shock or fire. Contact a qualified service technician for all service requirements.
- Keep combustible materials away from the unit.

CAUTION

- Do not put hands or any objects into the air inlets or outlets. This may cause personal injury or damage the unit.
- When cleaning, be careful not to splash water on the unit. Doing this may cause electric shock or damage to unit.
- In the event of a failure (burning smell, etc.), immediately disconnect all electrical power to indoor and outdoor units.

SYSTEM PARTS

Indoor unit

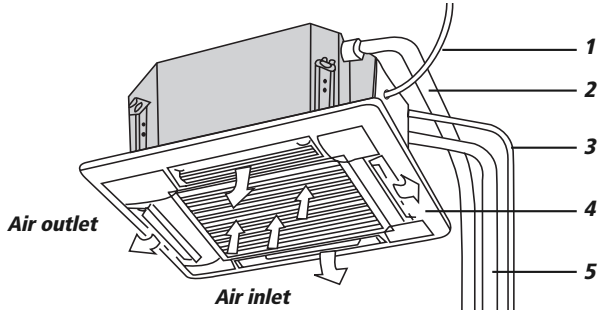

Part Name

1. Power Supply and Communication Wires
2. Drain Pipe
3. Liquid Pipe
4. Decorative Discharge Air Grille (sold separately)
5. Gas Pipe
6. Wired Tether Controller
7. Remote Controller
8. Service Cover
9. Power Supply and Communication Wires
10. Front Panel
11. Outdoor Power Supply
12. Liquid Pipe
13. Gas Pipe
14. Drain Hose

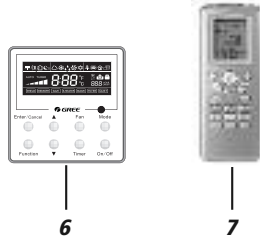

Outdoor Unit

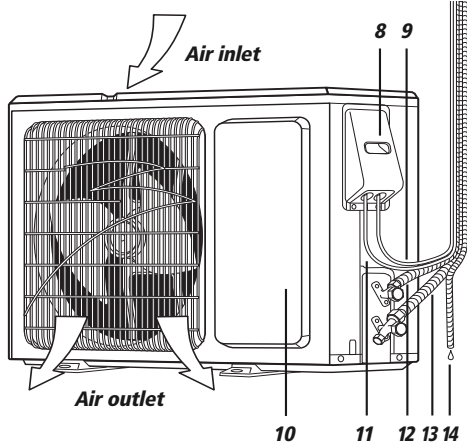

Part Numbers	Description
CASGRILLE15M	Decorative Grille for 12,000 & 18,000 BTU Cassettes
CASGRILLE1LG	Decorative Grille for 24,000 BTU Cassette
MC20700140	XK-19 Wired Tether Controller with touch buttons.

⚠ CAUTION

The refrigerant pipe, drain pipe and electrical wiring for this unit should be installed by a qualified HVAC professional only.

SYSTEM FUNCTIONS

WHISPER QUIET

Not only are the Gree systems energy efficient but they are quiet too. Ceiling Cassette operates with sound levels starting as low as 37 dB(A).

MULTI FAN SPEEDS

Whether operating in either Cooling or Heating mode, the indoor fan can be set to your choice of three different speeds (Low, Medium or High) to achieve maximum comfort.

BUILT IN CONDENSATE LIFT PUMP

The unit features a built-in drain pump that lifts condensate up to 39 inches above the drain pan to a gravity condensate drain system. In most cases, the internal condensate lift mechanism will avoid the need for an external condensate pump.

CONDENSATE SENTRY

The unit's fail-safe mechanism recognizes when there is a high level in the condensate pan and shuts off the system to prevent overflow.

INTELLIGENT PRE-HEATING

Multi21 Systems guard against the annoying cool air blown into the room in heating mode. The system constantly monitors the discharge air temperature. It will delay the indoor fan until the indoor coil has warmed up to prevent blowing uncomfortable cool air into the room.

CONTROLLERS

The Ceiling Cassette unit comes with a factory supplied Wireless Remote Controller and a Wired Tether Controller.

WIRELESS REMOTE

The Gree multi-functional infrared hand held wireless controller is sleek, ergonomically designed, easy to use and has a large backlit LCD display.

TETHER CONTROLLER

The Gree wired Tether Controller mounts to the wall up to 25 feet from the unit. It provides complete control over your unit's operation mode, desired temperature, fan speed, airflow direction and more.

SYSTEM FUNCTIONS

INTELLIGENT DEFROST

The Intelligent Defrost function increases room comfort and saves energy by eliminating unnecessary defrost cycles. In heating mode, the unit will monitor the outdoor coil for frost buildup. Once frost buildup has been detected, the system will switch into a defrost mode to remove the frost.

I FEEL MODE

The unit will sense room temperature at the remote controller instead of at the indoor unit. It then adjusts airflow and temperature accordingly for the ultimate in personal comfort control and energy savings. This function is only available with the wired Tether Controller.

SWING LOUVER

The adjustable swing louvers can be controlled from the wireless controller. Vertical swing louvers allows five different air discharge directions including Continuous Sweep. Maximize comfort by adjusting the direction of airflow in the room by moving the louvers up or down.

FRESH AIR INTAKE

The Ceiling Cassette has a ventilation air knockout that allows a 4-inch flex duct connection and a field-supplied duct booster fan. The maximum fresh air allowed is 20% of the unit's high-speed fan airflow rating.

POWER FAILURE MODE

Power interruptions are no problem for the Multi21 system. User selections and system parameters are stored in non-volatile memory. These parameters are retained during a power failure. When power is returned, the Ceiling Cassette system will automatically return to the last operating mode.

TURBO MODE

Use Turbo Mode for situations where you wish to achieve the desired room temperature in the shortest possible time. This mode runs the unit at ultra high speeds for quickest results.

CLOCK

The wireless remote controller has a built-in clock feature. The remote will display the time of day in a 24-hour format.

TIMER MODE

The unit can be programmed to turn ON or OFF after a specific amount of time. The time period is adjustable between one half and 24 hours.

SYSTEM FUNCTIONS

MODE BUTTON

The unit can be set to five different operating modes: HEAT, COOL, DRY, FAN ONLY and AUTO.

NOTE: AUTO MODE has fixed setpoints of 68° F heating and 77° F cooling, which are not adjustable. The system will automatically select heating or cooling to maintain room temperature within this band.

SLEEP MODE

The unit will automatically adjust room temperature during your sleep time. This slight change in temperature will not affect your comfort level due to the natural effects that sleeping has on the body, but it will save on energy consumption and will lower electric bills.

X-FAN MODE

When operating in humid areas, the X-fan or Dry Coil function allows the indoor fan to run for a pre-determined amount of time after the unit is turned off (cooling or dry modes) to ensure that additional moisture is removed from coil.

FAHRENHEIT °F / CELSIUS °C

The remote controller can be set to display in either °F or °C.

SELF-DIAGNOSIS

With an on-board computer using real-time diagnostics, the Gree Multi21 system helps to prolong its own life. The automatic diagnosis feature continuously scans for unacceptable operating conditions or malfunctions. If such conditions occur, the system takes corrective action or stops. Error codes are shown on the unit display to facilitate easy troubleshooting and repair.

PRIVACY LOCK MODE

The wireless remote controller has a Privacy Lock. The Privacy Lock averts unauthorized access or tampering with system settings.

AGENCY LISTINGS

All systems are listed with AHRI (Air conditioning, Heating, and Refrigeration Institute) and are ETL certified per UL Standards.

OPERATION OF WIRELESS REMOTE CONTROLLER

Remote Controller

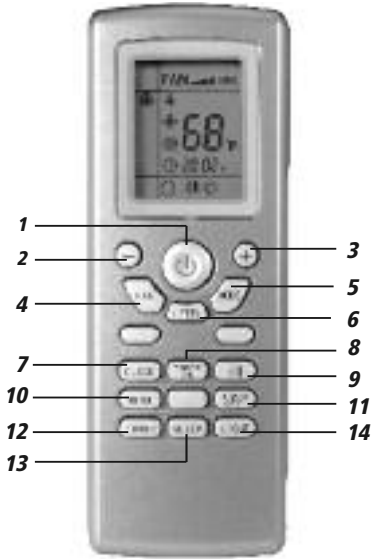

Part Name

1. ON/OFF Button
2. Down Button
3. Up Button
4. Fan Button
5. Mode Button
6. I Feel Button
7. Clock Button
8. Timer On Button
9. Swing Louver Button
10. X-Fan Button
11. Timer Off Button
12. Turbo Button
13. Sleep Button
14. Light Button

INTRODUCTION FOR ICONS ON DISPLAY SCREEN

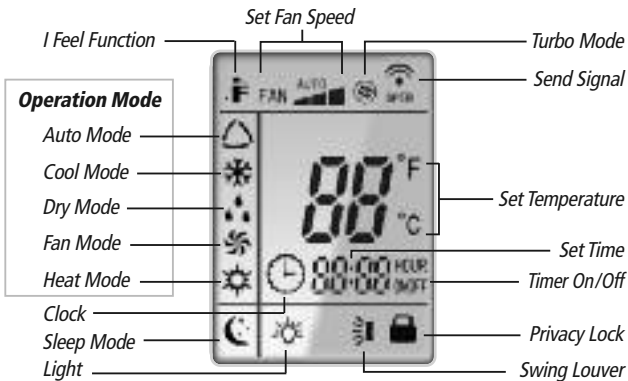

OPERATION OF WIRELESS REMOTE CONTROLLER

REMOTE CONTROLLER OPERATIONS

The wireless remote controller is sleek, versatile and allows you to change room temperatures and functions on your Multi21 Ceiling Cassette system from the palm of your hand. The large LCD display and buttons make it easy-to-understand and easy-to-use.

The remote controller is set from factory to display temperatures in °F. If °C is desired, turn the remote controller **OFF** with the **ON/OFF** button and then press "**MODE**" and "**▼**" buttons on the remote simultaneously for 5 seconds.

ON/OFF BUTTON

When the system is in **OFF** mode, the remote controller will display the time and last room setpoint. When you press the **ON/OFF** button, this indicator  will be displayed and the unit will start in the last operating mode and room setpoint.

NOTE: If the **ON/OFF** button is pressed too soon after a stop, the compressor will not start for 1 to 5 min. due to the inherent protection against frequent compressor cycling.



ON Mode Display

4-DIMENSION SWING LOUVERS

- Press the Vertical Swing Louver button to select five different vertical (up & down) air discharge directions including Continuous Sweep. The Swing Louver  icon will be displayed. Press this button to set swing angle, which changes in direction as below:

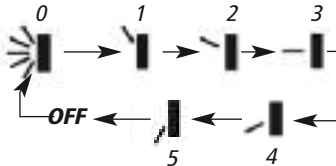

 Indicates louver swings back and forth in the five directions, as shown.



Swing Louver Display

OPERATION OF WIRELESS REMOTE CONTROLLER

MODE BUTTON

Use the “**MODE**” button to select one of the available modes. The selected mode will be displayed on the remote controller and the appropriate light will illuminate on the front display panel.

AUTO – Unit will automatically select heating or cooling to maintain room temperature between 68°F and 77°F. The remote controller will display the Auto Mode icon with no setpoint.

COOL – To cool to selected setpoint and remove moisture. Press ▲ or ▼ to adjust set temperature. System varies compressor speed to maintain desired temperature.

HEAT – To heat to selected room setpoint. Press ▲ or ▼ to adjust set temperature. System varies compressor speed to maintain desired room temperature.

FAN ONLY – To circulate air without heating or cooling. Use Fan Speed button to select speed from low to high.

DRY – Select **DRY MODE** to increase moisture removal during warm humid conditions. In this mode, fan speed cannot be adjusted.

1. If the Room Temperature is above or equal to the set temperature, the system will be operating with high fan speed for several minutes and then it will switch to the selected fan speed.
2. If the Room Temperature is below the set temperature, the system will be OFF and the indoor fan will be at low speed.

I FEEL MODE

Press this button to use the I FEEL function, and the () icon will be displayed. The unit will sense room temperature at the remote controller instead of at the indoor unit. It then adjusts airflow and temperature accordingly for the ultimate in personal comfort control and energy savings. Press the button again to exit this function. For best performance, keep remote controller away from heat or cold temperature sources while using this function.

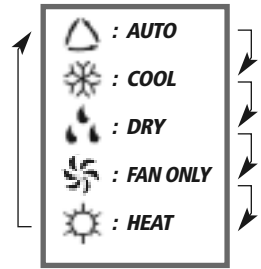

Icons Displayed



I Feel Mode

OPERATION OF WIRELESS REMOTE CONTROLLER

TIMER SETTING

Timer-ON / Timer-OFF BUTTON

To set when you want the unit to turn On at the end of a selected time period, use the button labeled "Timer-ON/Timer-OFF" on the remote controller. Press this button to make the clock icon disappear, replaced with the word "ON" (blinking). Press ▲ or ▼ buttons to adjust timer setting 1 minute at a time. Press and hold ▲ or ▼ button to set timer more quickly. Press "Timer-ON/Timer-OFF" button again to confirm setting, and the word "ON" will stop blinking. To cancel, press "Timer-ON/Timer-OFF" button again.



Timer Setting ON/OFF

To set when you want the unit to turn Off at the end of a selected time period, use the same button. Press this button to make the clock icon disappear, replaced with the word "OFF" (blinking). Adjust settings the same as with "Timer-ON/Timer-OFF" settings.

NOTE: Under Timer On and Off status, you can set "Timer-ON/Timer-OFF" simultaneously. Before setting timer, be sure to set clock to correct time.

TURBO MODE

The desired room setpoint can be achieved faster in **TURBO** mode. After selecting the "HEAT" or "COOL" mode button, push the "TURBO" button. The **TURBO**  icon will be displayed on the remote controller and the unit will run at an ultra-high speed. To deactivate the feature, push the "TURBO" button again. The unit will return to normal operation.



Turbo Mode Display

LIGHT BUTTON

Press this button to turn off display light on indoor unit. Press again to turn it back on.



Light Display

OPERATION OF WIRELESS REMOTE CONTROLLER

FAN BUTTON

Press the FAN button to adjust the indoor fan speed:
Low (▲), Medium (▲▲), High (▲▲▲), Turbo and Auto.

- Turbo function is not available in Dry and Auto mode.
- The fan operates at low speed in Dry and Auto modes, and the speed cannot be adjusted.
- When Auto is selected, the unit will select the proper fan speed automatically, according to the ambient temperature.



Fan Display

NOTE: Turbo function is not available in Dry and Auto Modes. The Multi21 Ceiling Cassette unit will select proper fan speed automatically according to ambient temperature.

CLOCK SETTING

Press this button to set clock time. "⌚" icon on remote controller will blink. Within 5 seconds, press ▲ or ▼ button to set clock time. With each pressing of ▲ or ▼ buttons, clock time will increase or decrease 1 minute. To quickly adjust time setting, press and hold ▲ or ▼ button for 2 seconds. Release button when you have reached the desired time setting. Press "CLOCK" button to confirm the time, and "⌚" icon will stop blinking.



Clock Setting Display

NOTE: Clock time adopts 24-hour mode. A 12-hour time format is not available.

PRIVACY LOCK

The Privacy Lock prevents unauthorized access to the unit controls and prevents tampering with system settings. The remote controller can be locked by pushing the "▲" and "▼" buttons simultaneously for 5 seconds. The Privacy Lock icon will be displayed on the remote controller. Repeat the process to unlock the remote controller.



Privacy Lock Display

OPERATION OF WIRELESS REMOTE CONTROLLER

SLEEP MODE

The Multi21 Ceiling Cassette system will automatically adjust room temperature during your sleep time. This slight change in temperature will not affect your comfort level due to the natural effects that sleeping has on the body, but it will save on energy consumption and will lower your electric bill. Press the SLEEP button to select Sleep mode or Cancel. The SLEEP  icon will appear.



Sleep Mode Display

TRADITIONAL MODE - SLEEP

In Traditional Mode the unit will slowly relax the room set temperature by up to 4° F until Sleep Mode is cancelled.

In Cool or Dry modes:

The unit will run at current room setpoint for 1 hour. After 1 hour, the setpoint will increase by 2°F (1°C). After 2 hours, the setpoint will increase by 4°F (2°C) and maintain this setpoint until Sleep Mode is cancelled.

In Heat mode:

The unit will run at current room setpoint for 1 hour. After 1 hour, the setpoint will decrease by 2° F (1°C). After 2 hours, the setpoint will decrease by 4°F (2°C) and maintain this setpoint until Sleep Mode is cancelled.

OPERATION OF WIRELESS REMOTE CONTROLLER

CHANGING BATTERIES AND ADDITIONAL NOTES

To change batteries, slide cover off battery compartment on back of remote controller. Remove and safely discard old batteries. Insert two new AAA 1.5V dry batteries, using correct polarity. Reattach back cover.

NOTE:

- If the remote controller will not be used for a long time, remove batteries to prevent leakage damage.
- Be sure to aim the remote controller at the receiver of the main unit when operating.
- When remote emits a signal, icon will flicker; a tone will be heard when unit receives that signal.

CHANGING BATTERIES

**Remove
old batteries**

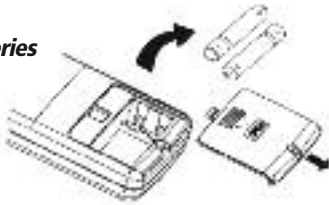

**Install
new batteries**

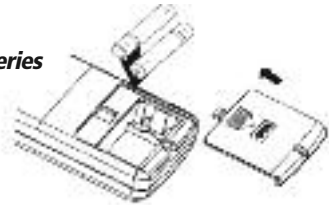

OPERATION OF WIRED TETHER CONTROLLER

ON/OFF BUTTON

Press On/Off to turn On the unit. Press again to turn it Off.

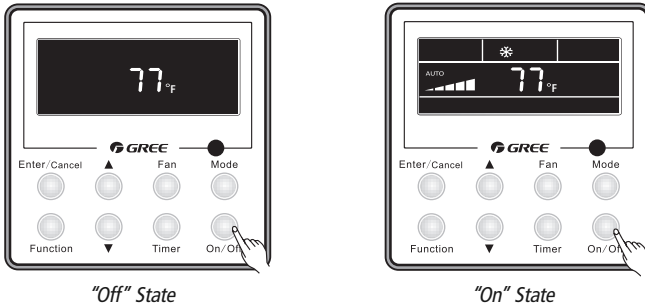

MODE SETTING

When the unit is ON, press Mode button to select an operating mode. It will change sequentially as shown below: Auto–Cool–Dry–Fan–Heat

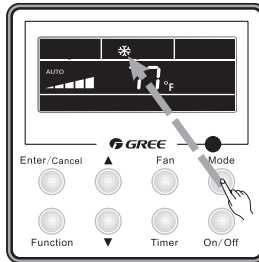
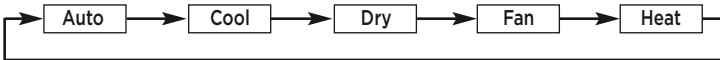

TEMPERATURE SETTING

Press ▲ or ▼ to increase/decrease the setpoint temperature as shown below. In Cool, Dry, Fan or Heat mode, the setpoint temperature range is 61°-86°F. In Auto mode, the setpoint temperature is not adjustable.

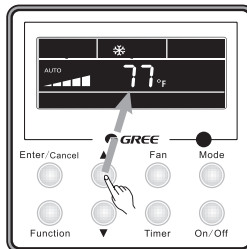

OPERATION OF WIRED TETHER CONTROLLER

FAN SETTING

When the unit is ON, press Fan button to select the fan speed of the indoor unit. It will change sequentially as shown below.

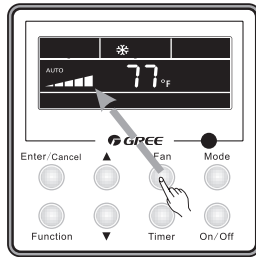
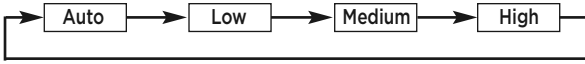

TURBO MODE

Turbo mode will force the unit up to maximum capacity to heat or cool the room in the shortest amount of time. Turbo Mode can only be used on Heat or Cool modes.

Turbo Setting

Press Function button until the Turbo icon is displayed. Then press Enter/Cancel to confirm. To cancel, press the Function button to re-enter the Turbo setting status, then press Enter/Cancel.

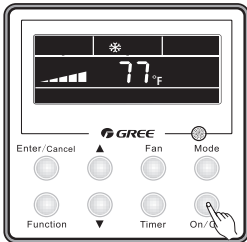

Turn On the unit and select Heat or Cool mode.

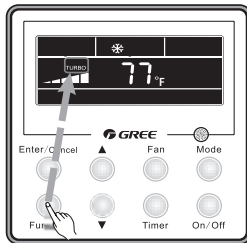

Press Function until Turbo mode Icon is displayed.

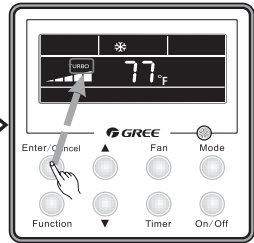

Press Enter/Cancel to start Turbo mode.

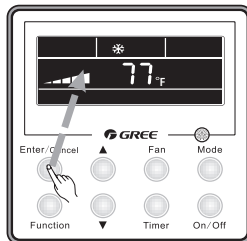

Cancel Turbo Mode

To cancel, press Function button to re-enter the Turbo settings, then press Enter/Cancel button.

OPERATION OF WIRED TETHER CONTROLLER

TIMER SETTING

The Multi21 System has two timer modes. The Timer-On mode will turn the unit ON after the preset time period. The Timer-Off Mode will turn the unit OFF after the preset time period. The preset time period can be from 0.5 to 24 hours in 0.5 hour increments.

Timer-On Setting

Turn the unit Off, press the Timer button. The OFF icon will flash and the hours will be displayed. Set the time period for the unit to remain OFF before turning ON by pressing the ▲ or ▼ buttons. Press Timer button to confirm and start Timer-On mode.

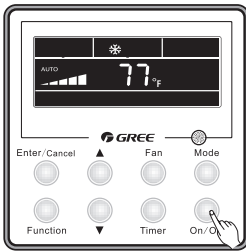

Turn Off the unit.

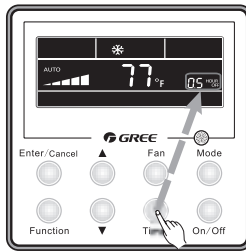

Press Timer button to select Timer On mode.

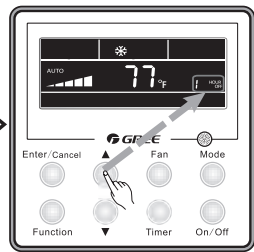

Press ▲ or ▼ to select time period.

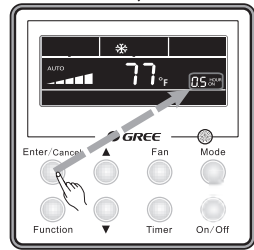

Press Enter/Cancel to start timer mode.

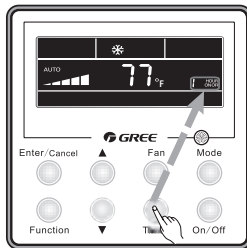

Cancel Timer

Timer modes can be cancelled anytime by pressing the Timer button.

OPERATION OF WIRED TETHER CONTROLLER

Timer-Off Setting

Turn the unit On, press the Timer button. The ON icon will flash and the hours will be displayed. Set the time period for the unit to remain ON before turning OFF by pressing the ▲ or ▼ buttons. Press Timer button to confirm and start Timer-Off mode.

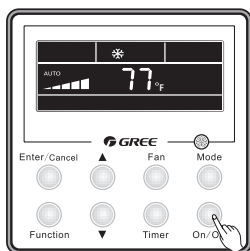

Turn On the unit and select Heat or Cool mode.

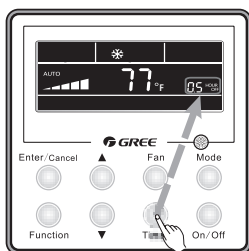

Press Timer button to select Timer Off mode.

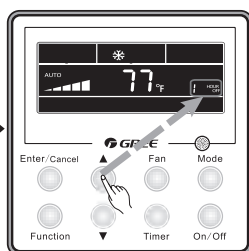

Press ▲ or ▼ to select time period.

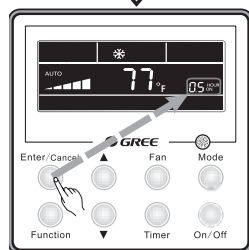

Press Enter/Cancel to start timer mode.

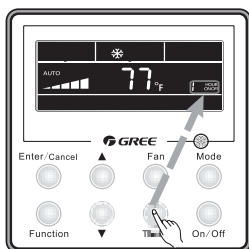

Cancel Timer

Timer modes can be cancelled anytime by pressing the Timer button.

OPERATION OF WIRED TETHER CONTROLLER

SLEEP MODE

The unit will automatically adjust room temperature during your sleep time. This slight change in temperature will not affect your comfort level due to the natural effects that sleeping has on the body, but it will save on energy consumption and will lower your electric bill. Press the SLEEP button to select Sleep Mode. The SLEEP  icon will appear.

In Cool or Dry modes:

The unit will run at current room setpoint for 1 hour. After 1 hour, the setpoint will increase by 2° F. After 2 hours, the setpoint will increase by 4° F and maintain this setpoint until Sleep Mode is canceled.

In Heat mode:

The unit will run at current room setpoint for 1 hour. After 1 hour, the setpoint will decrease by 2° F. After 2 hours, the setpoint will decrease by 4° F and maintain this setpoint until Sleep Mode is canceled.

Sleep Setting

Turn the unit On and select a mode (ex. Heat, Cool, or Dry). Press the Function button until the Sleep icon appears on the display. Press the Enter/Cancel button to start Sleep Mode.

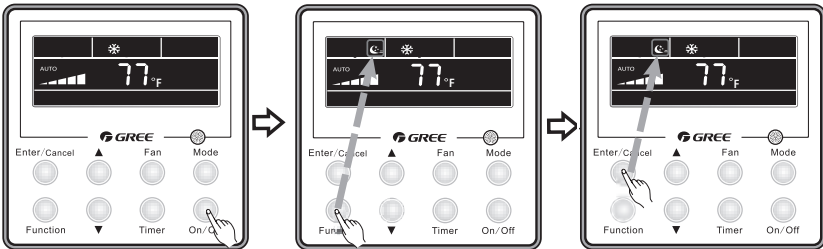

Turn On the unit and select a mode.

Press Function until the Sleep icon is displayed.

Press Enter/Cancel to start Sleep Mode.

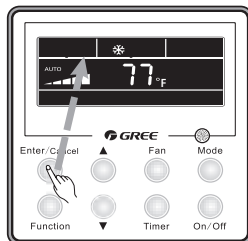

Cancel Sleep Mode

Press Function until the Sleep icon appears.
Press the Enter/Cancel button to cancel Sleep Mode.

OPERATION OF WIRED TETHER CONTROLLER

X-FAN MODE

The X-Fan function may only be selected in Cool and Dry modes. After the unit is turned Off, the X-Fan function will keep the indoor fan running for 2 minutes to dry the indoor evaporator coil to help avoid mold and mildew growth.

X-Fan Settings

Turn the unit On and select Cool or Dry mode. Press Function button until X-fan icon is displayed and then press Enter/Cancel to activate this function.

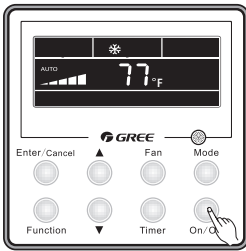

Turn On the unit, select Cooling or Dry mode.

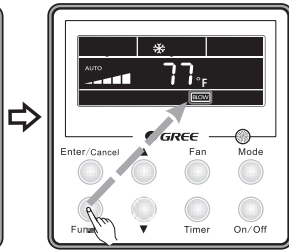

Press Function until the X-fan icon is displayed.

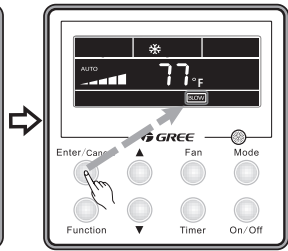

Press Enter/Cancel to start X-fan mode.

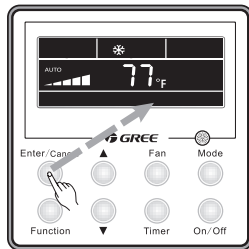

Cancel X-Fan Mode

To cancel, press Function button to re-enter the X-Fan settings, then press Enter/Cancel button.

OPERATION OF WIRED TETHER CONTROLLER

I-FEEL MODE

The indoor unit will sense room temperature at the wired Tether Controller instead of at the return air section of the indoor unit.

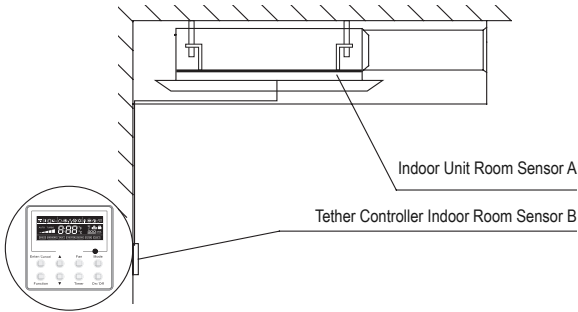

I-Feel Settings

Press the Function button until the I-Feel icon is displayed, then press Enter/Cancel to activate the function.

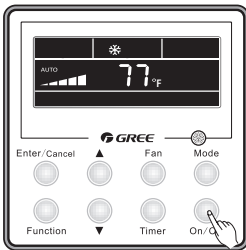

Turn Unit On.

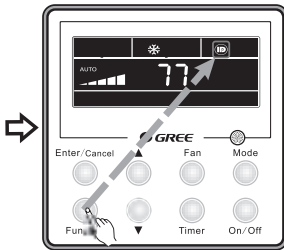

Press Function until the I-Feel icon is displayed.

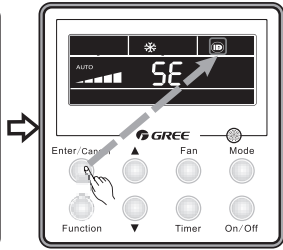

Press Enter/Cancel to start I-Feel mode.

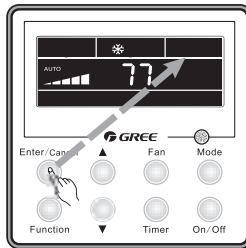

Cancel I-Feel Mode

To cancel, press Function button to re-enter the I-Feel settings, then press Enter/Cancel button.

OPERATION OF WIRED TETHER CONTROLLER

POWER FAILURE MODES

The unit has two selectable system power up modes:

IMPORTANT: This mode arrives set at “factory default,” but should not be left there. It must be reset to “Power Failure Recovery,” especially for use in commercial IT/server/computer rooms.

Power Failure Recovery

After the initial power up, the unit will store user selections and system parameters in non-volatile memory. These parameters are retained during a power failure. When power is returned, the system will automatically return to the last operating mode.

Power Failure Standby

The system will power up in standby or off mode. This is the factory default setting.

POWER FAILURE MODE SETTINGS

To set Power Failure Recovery Mode, turn the unit OFF and press the Mode and ▲ buttons simultaneously for 5 seconds until the MEMORY Icon is displayed.

Repeat the process to select Standby mode. In Standby mode the Memory icon is not displayed.

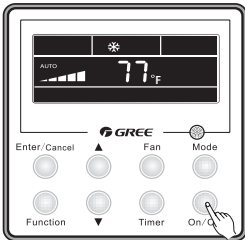

Turn Unit Off.

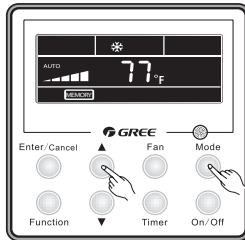

Press Mode and ▲ buttons 5 sec until MEMORY icon is displayed.

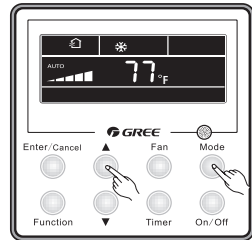

Repeat to change Modes.

OPERATION OF WIRED TETHER CONTROLLER

CELSIUS OR FAHRENHEIT TEMPERATURE DISPLAY

The wired Tether Controller is set from the factory to display temperature in Fahrenheit (F°). If Celsius (C°) is desired, turn the unit OFF, press Mode and ▼ buttons at the same time for 5 seconds to alternate between temperature displays.

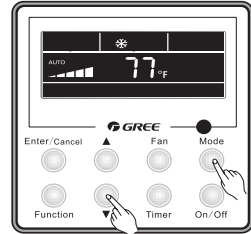

To change temperature display.

PRIVACY LOCK

The Privacy Lock prevents unauthorized access to the unit controls and prevents tampering with system settings. To lock the wired Tether Controller, press ▲ and ▼ buttons simultaneously for 5 seconds and the Lock Icon will be displayed.

Repeat the process to unlock the Tether Controller and cancel Privacy Lock.

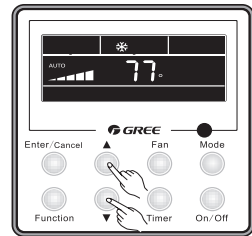

To activate Privacy Lock.

CARE AND CLEANING

Routine maintenance consists of checking the condensate drain for clogs, hosing off the outdoor coil of outdoor unit and cleaning the air filter and the indoor decorative grille.

WARNING

Turn off power and disconnect from indoor and outdoor units before cleaning. Failure to do so could cause electric shock.

DECORATIVE GRILLE CLEANING

Wash the decorative grille using warm water and mild detergent with a soft cloth or soft brush.

NOTE: Do not use bleach, abrasives or water above 110°F (45°C) as it may cause discoloration or damage to the surface of the unit.

AIR FILTER CLEANING

Changing your air filter on a regular basis prevents many problems. Dirty air filters will affect the performance and the longevity of your unit. It is recommended that air filters be cleaned every three (3) months.

HOW TO REMOVE AIR FILTER

For the 24K cassette unit:

1. Push the latch as shown in the figure
2. Release the screws under clasps by a screwdriver.
3. Release the fastener and open the panel grille.



Remove the screw

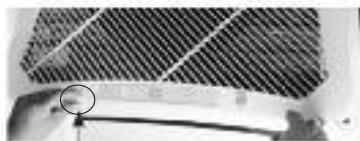

Push the fastener

CARE AND CLEANING

For the 12 and 18K cassette unit:

1. Remove screws with a screwdriver as shown.
2. Release the two fasteners and open the panel grille.

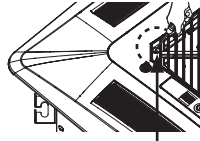

Remove the screw

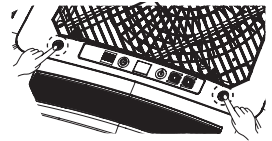

Push the fastener

Disassemble the air inlet grille:

1. Open the air inlet grille at 45°, lift up and remove the grille.
2. Disassemble the filter screen and remove it from the filter door.

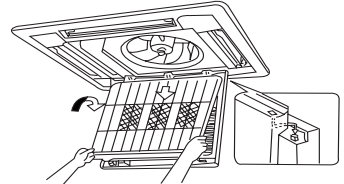
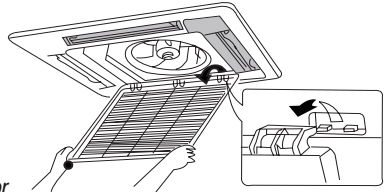

HOW TO CLEAN AIR FILTER

1. Clean dust, lint and dirt from the air filter using a vacuum cleaner or washing with water. If dirt is conspicuous, wash with a mild detergent in lukewarm water. After washing air filter with water, let dry in the shade. Do not expose the air filter to direct sunlight or direct heat to dry.
2. Reinsert the air filter into filter door, careful to align properly.
3. Close secure filter door.

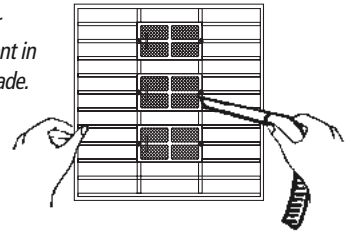

Re-install grille assembly

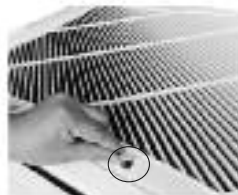

Replace the screw

TROUBLESHOOTING

PROBLEM	CAUSE/SOLUTION
System does not restart.	<p>Cause: The system has a built-in three-minute delay to prevent short and/or rapid cycling of the compressor.</p> <p>Solution: Wait three minutes for the protection delay to expire.</p>
Indoor unit emits unpleasant odor when started	<p>Cause: Typically unpleasant odors are the result of mold or mildew forming on the coil surfaces or the air filter.</p> <p>Solution: Wash indoor air filter in warm water with mild cleaner. If odors persist, contact a qualified service professional to clean the coil surfaces.</p>
You hear a "water flowing" sound.	<p>Cause: It is normal for the system to make "water flowing" or "gurgling" sounds from refrigerant pressures equalizing when the compressor starts and stops</p> <p>Solution: The noises should discontinue as the refrigerant system equalizes after two or three minutes.</p>
A thin fog or vapor coming out of the discharge register when system is running.	<p>Cause: It is normal for the system to emit a slight fog or water vapor when cooling extremely humid warm air.</p> <p>Solution: The fog or water vapor will disappear as the system cools and dehumidifies the room space.</p>
You hear a slight cracking sound when the system stops or starts.	<p>Cause: It is normal for the system to make "slight cracking" sounds from parts expanding and contracting during system starts and stops.</p> <p>Solution: The noises will discontinue as temperature equalizes after 2 or 3 minutes.</p>
The system will not run.	<p>Cause: There are a number of situations that will prevent the system from running.</p> <p>Solution: Check for the following:</p> <ul style="list-style-type: none"> • Circuit breaker is "tripped" or "turned off." • Power button of controller is not turned on. • Controller is in sleep mode or timer mode. • Otherwise, contact a qualified service professional for assistance.
The unit is not heating or cooling adequately.	<p>Cause: There are a number of reasons for inadequate cooling or heating.</p> <p>Solution: Check the following:</p> <ul style="list-style-type: none"> • Remove obstructions blocking airflow into the room. • Clean dirty or blocked air filter that is restricting airflow into the system. • Seal around door or windows to prevent air infiltration into the room. • Relocate or remove heat sources from the room.

TROUBLESHOOTING

PROBLEM	CAUSE/SOLUTION
<p>Water leaking from the indoor unit into the room.</p>	<p>Cause: While it is normal for the system to generate condensate water in cooling mode, it is designed to drain this water via a condensate drain system to a safe location.</p> <p>Solution: If water is leaking into the room, it may indicate one of the following.</p> <ul style="list-style-type: none">• The indoor unit is not level right to left. Level indoor unit.• The condensate drain pipe is restricted or plugged. All restrictions must be removed to allow continuous drainage by gravity.• If problem persists, contact a qualified service professional for assistance.
<p>The unit will not deliver air.</p>	<p>Cause: There are a number of system functions that will prevent air flow.</p> <p>Solution: Check for the following:</p> <ul style="list-style-type: none">• In heating mode, the indoor fan may not start for three minutes if the room temperature is very low. This is to prevent blowing cold air.• In heat mode, if the outdoor temperature is low and humidity is high, the system may need to defrost for up to 10 minutes before beginning a heating cycle.• In dry mode, the indoor fan may stop for up to three minutes during the compressor off delay.• Otherwise, you should contact a qualified service professional for assistance.

DIAGNOSTIC CODES

Troubleshooting

The unit has onboard diagnostics. The outdoor unit will provide status indicators. The indoor wall unit and remote controller will display error codes. The following is a summary of the codes with explanation:

Malfunction Name	Indoor Unit & Remote Display	Outdoor Unit Indicators		Possible Causes
		Yellow	Red	
Liquid Valve Coil Temperature Sensor Malfunction	b5			<ol style="list-style-type: none"> 1) Loose or bad connection between sensor and control board 2) Liquid valve temperature sensor damaged 3) Control board malfunction
Gas valve temperature sensor is open/short circuited	b7			Hardware malfunction
System Configuration Malfunction	C5			<ol style="list-style-type: none"> 1) No jumper cap inserted on the control board 2) Incorrect or damaged jumper cap on control board 3) Indoor and outdoor units are not compatible
Wrong connection of communication wire or malfunction of electronic expansion valve	dn			Hardware malfunction
System High Pressure	E1			<ol style="list-style-type: none"> 1) Over charged with refrigerant 2) Blocked or dirty outdoor coil 3) Extreme outdoor ambient conditions
Indoor Anti-Freeze Protection	E2	3 flashes and 1 sec Off		<ol style="list-style-type: none"> 1) Low return airflow 2) Indoor fan speed is too low 3) Indoor coil is blocked or dirty
Low Pressure Protection	E3		9 flashes and 1 sec Off	<ol style="list-style-type: none"> 1) Low on refrigerant 2) Pressure sensor is damaged
Compressor High Discharge Temperature Protection	E4	7 flashes and 1 sec Off		Please refer to the malfunction analysis (discharge temperature, overload) in service manual
Overcurrent Protection	E5	5 flashes and 1 sec Off		<ol style="list-style-type: none"> 1) Supply voltage is unstable 2) Supply voltage is too low and system load is too high 3) Indoor coil is blocked or dirty
Communication Malfunction	E6	Continuous On		<ol style="list-style-type: none"> 1) Communication cable is mis-wired between indoor and outdoor units 2) Indoor or Outdoor control board malfunction
Mode conflict (Indoor units calling for simultaneously Heating and Cooling)	E7			Operation status

DIAGNOSTIC CODES

Malfunction Name	Indoor Unit Display	Outdoor Unit Indicators		Possible Causes
		Yellow	Red	
High Temperature Resistant Protection	E8	6 flashes and 1 sec Off		1) Incorrect refrigerant charge level 2) Refrigerant metering device malfunction 3) Compressor malfunction
Cold Air Protection	E9			1) Indoor coil has not reach minimum heating temperature 2) Indoor ambient is abnormally cold 3) Indoor control board malfunction
EEPROM Memory Malfunction	EE	11 flashes and 1 sec Off		Control board malfunction
Module Phase Current Protection - Frequency Decrease/Limit Mode	En			Outdoor control board malfunction
Module Temperature Protection - Frequency Decrease/Limit Mode	EU		11 flashes and 1 sec Off	1) IPM module over heating or malfunctioning 2) Improper voltage at IPM Module
Refrigerant Leakage Protection	F0		9 flashes and 1 sec Off	1) refrigerant leak(s) 2) Indoor coil temperature sensor no calibrated 3) Refrigerant flow is restricted (ex. valve, exv, debris)
Indoor Ambient Temperature Sensor Malfunction	F1			1) Loose or bad connection between sensor and control board 2) Indoor ambient temperature sensor damaged 3) Control board malfunction
Indoor Coil Temperature Sensor Malfunction	F2			1) Loose or bad connection between sensor and control board 2) Indoor coil temperature sensor damaged 3) Control board malfunction
Outdoor Ambient Temperature Sensor Malfunction	F3		6 flashes and 1 sec Off	1) Loose or bad connection between sensor and control board 2) Outdoor ambient temperature sensor damaged 3) Control board malfunction
Outdoor Coil Temperature Sensor Malfunction	F4		5 flashes and 1 sec Off	1) Loose or bad connection between sensor and control board 2) Outdoor coil temperature sensor damaged 3) Control board malfunction
Outdoor Discharge Temperature Sensor Malfunction	F5		7 flashes and 1 sec Off	1) Loose or bad connection between sensor and control board 2) Discharge temperature sensor damaged 3) Control board malfunction
Compressor Overload Protection - Frequency Decrease/Limit Mode	F6		3 flashes and 1 sec Off	1) Incorrect refrigerant charge 2) Metering device malfunction 3) Compressor malfunction
Oil Return Protection - Frequency Decrease/Limit Mode	F7			Normal function status code only
System Current Overload Protection - Frequency Decrease/Limit Mode	F8		1 flashes and 1 sec Off	1) Input voltage too low 2) System pressure too low

DIAGNOSTIC CODES

Malfunction Name	Indoor Unit Display	Outdoor Unit Indicators		Possible Causes
		Yellow	Red	
High Compressor Discharge Temperature - Frequency Decrease/Limit Mode	F9	2 flashes and 1 sec Off	4 flashes and 1 sec Off	<ol style="list-style-type: none"> 1) Cooling load is too great 2) Outdoor ambient temperature too high 3) Refrigerant charge too low 4) Metering device malfunction
Indoor Coil Freeze Protection - Frequency Decrease/Limit Mode	FH			<ol style="list-style-type: none"> 1) Indoor coil has not reach minimum heating temperature 2) Indoor ambient is abnormally cold 3) Indoor control board malfunction
Pump Down or Gathering Refrigerant Status	Fo	17 flashes and 1 sec Off		Optional Service Mode
Defrost Mode in Heating	H1			Operation status
Compressor Overload Protection	H3	8 flashes and 1 sec Off		<ol style="list-style-type: none"> 1) Wiring terminal OVC-COMP is loose 2) Refer to the malfunction analysis in Service Manual
IPM Module Protection	H5	4 flashes and 1 sec Off		<ol style="list-style-type: none"> 1) IPM module over heating 2) Improper or Low voltage at the IPM module 3) IPM module malfunction
Indoor DC Fan Motor Malfunction	H6			<ol style="list-style-type: none"> 1) Loose connections between fan motor and control board 2) Fan motor or blower wheel bearings malfunction 3) Control board malfunction
Compressor De-Synchronized Malfunction	H7			<ol style="list-style-type: none"> 1) Compressor voltage is not balance 2) Control board malfunction 3) Compressor malfunction
Power Factor Correction (PFC) Protection	HC	14 flashes and 1 sec Off		<ol style="list-style-type: none"> 1) Mis-wiring of the reactor filter and PFC capacitor 2) Reactor filter or PFC capacitor malfunction 3) Control board malfunction
Compressor Demagnetization Protection	HE			Compressor malfunction
High Input Power Protection	L9	9 flashes and 1 sec Off		<ol style="list-style-type: none"> 1) Compressor malfunction 2) Power circuit malfunction
Start-Up Malfunction	LC			<ol style="list-style-type: none"> 1) Over charged with refrigerant 2) Control board malfunction 3) Compressor malfunction
Compressor phase-lacking/phase-inverse protection	Ld			Hardware malfunction

DIAGNOSTIC CODES

Malfunction Name	Indoor Unit Display	Outdoor Unit Indicators		Possible Causes
		Yellow	Red	
Incompatible Indoor and Outdoor Units	LP	16 flashes and 1 sec Off		Indoor and outdoor units are not compatible
Compressor Phase Current Protection	P5			1) IPM module malfunction 2) Outdoor control board malfunction 3) Compressor malfunction
Module Temperature Sensor Malfunction	P7			Outdoor control board malfunction
Module Temperature Protection	P8			1) Lack of thermal grease on IPM module 2) Heat sink (radiator) not tightly mounted 3) Control board malfunction
High DC Bus Voltage Protection	PH	13 flashes and 1 sec Off		1) Supply voltage on L1 and N is above 265Vac 2) Capacitor on control board malfunction 3) Outdoor control board malfunction
Low DC Bus Voltage Protection	PL	12 flashes and 1 sec Off		1) Supply voltage on L1 and N is below 150Vac 2) Capacitor on control board malfunction 3) Outdoor control board malfunction
Capacitor Charging Malfunction	PU			Capacitor malfunction
Compressor Phase-Current Detection Malfunction	U1			Outdoor control board malfunction
DC Bus Voltage Dip	U3			Outdoor control board malfunction
Input Current Detection Malfunction	U5			Outdoor control board malfunction
The four-way valve is abnormal	U7			Hardware malfunction
Zero cross detection circuit malfunction(for indoor unit)	U8			Hardware malfunction

Notes: 1) During defrosting process, the heating indicator is on for 10s and off for 0.5s.
2) Refer to Service Manual for additional information.

ENERGY SAVING TIPS

- 1. Relaxing room temperature at night is OK:** During the nighttime hours you don't require the same level of conscious cooling or heating. Try using Sleep Mode to gradually relax room temperature and allow the unit to run less and save energy.
- 2. Curtains and shades:** In the summer, you need to block the effects of the sun. Close window curtains and shades on the south and west side of your home to help block solar heat. In winter, the sun is your friend. Open curtains and shades to allow solar heat into your room.
- 3. Close doors:** If you don't need to heat and cool your whole home, confine the heating and cooling to one room by closing doors. Limit the space you're heating and cooling to specified capability of the unit.
- 4. Service the unit:** Some basic maintenance might be all you need. The outdoor unit will greatly benefit from a good hosing out, especially in treed areas where seeds and other debris can stick to coil fins and make the unit work up to 15% harder!
- 5. Rearrange the room:** Furniture that obstructs airflow means you could be heating and cooling the back of a chair or the front of a sofa instead of the actual living space. Remove or rearrange obstacles blocking airflow.
- 6. Try 75 degrees:** 75°F is a good point for an air conditioner to run at its optimal performance level. Even a 5-degree change in temperature can make your unit use up to 40% more energy!
- 7. Lighting:** Turning lights off can help reduce your heat. Each light bulb is a tiny heater. Your air conditioner must waste energy overcoming the heat from your lights to reach and hold your desired room temperature.
- 8. Is anyone home?** If possible, while you're away turn your unit to Auto mode and make sure windows and drapes are closed. Although room temperature may be less than optimal for a few minutes when you come home, the unit will soon have the room back to your desired temperature.
- 9. Don't forget the fan:** The fan is much like a car. The faster it runs, the more energy it uses. Sometimes we need the car to go fast, but slow is good enough most of the time. Try saving money by using the comfortable quiet low fan speed as much as possible.



GREE ELECTRIC APPLIANCES, INC.

www.greecomfort.com



LIMITED WARRANTY

GREE distributor (hereinafter "Company") warrants this product against failure due to defect in materials or workmanship under normal use and maintenance as follows. All warranty periods begin on the date of original installation. If the date cannot be verified, the warranty period begins one hundred twenty (120) days from date of manufacture. If a part fails due to defect during the applicable warranty period Company will provide a new or remanufactured part, at Company's option, to replace the failed defective part at no charge for the part. This limited warranty is subject to all provisions, conditions, limitations and exclusions listed below.

- Seven (7) years on compressor and Five (5) years on all parts to the original registered end-user.
- One (1) year warranty on remote controller unit.
- Proper installation – Limited warranty applies only to systems that are installed by a state certified or licensed HVAC contractor, under applicable local and state law in accordance with all applicable building codes and permits; GREE installation and operation instructions and good trade practices.
- Warranty applies only to products remaining in their original installation location.
- Defective parts must be returned to the distributor through a registered servicing dealer for credit.

LIMITATIONS OF WARRANTIES: ALL IMPLIED WARRANTIES AND/OR CONDITIONS (INCLUDING IMPLIED WARRANTIES OR CONDITIONS OF MERCHANTABILITY AND FITNESS FOR A PARTICULAR USE OR PURPOSE) ARE LIMITED TO THE DURATION OF THIS LIMITED WARRANTY, SOME STATES OR PROVINCES DO NOT ALLOW LIMITATIONS ON HOW LONG AN IMPLIED WARRANTY OR CONDITION LASTS, SO THE ABOVE MAY NOT APPLY TO YOU. THE EXPRESS WARRANTIES MADE IN THIS WARRANTY ARE EXCLUSIVE AND MAY NOT BE ALTERED, ENLARGED, OR CHANGED BY ANY DISTRIBUTOR, DEALER, OR OTHER PERSON, WHATSOEVER.

THIS WARRANTY DOES NOT COVER:

1. Labor or other costs incurred for diagnosing, repairing, removing, installing, shipping, servicing or handling of either defective parts, or replacement parts, or new units.
2. Normal maintenance as outlined in the installation and servicing instructions or Owner's Manual, including filter cleaning and/or replacement and lubrication.
3. Failure, damage or repairs due to faulty installation, misapplication, abuse, improper servicing, unauthorized alteration or improper operation.
4. Failure to start due to voltage conditions, blown fuses, open circuit breakers, or damages due to the inadequacy or interruption of electrical service.
5. Failure or damage due to floods, winds, fires, lightning, accidents, corrosive environments (rust, etc.) or other conditions beyond the control of the Company.
6. Parts not supplied or designated by Company, or damages resulting from their use.
7. Products installed outside USA and Canada.
8. Electricity or fuel costs, or increases in electricity or fuel costs from any reason whatsoever, including additional or unusual use of supplemental electric heat.
9. Any cost to replace, refill or dispose of refrigerant, including the cost of refrigerant.
10. Any special, indirect or consequential property or commercial damage of any nature whatsoever. Some states or provinces do not allow the exclusion of incidental or consequential damages, so the above limitation may not apply to you.

For additional warranty exclusions, visit www.GreeComfort.com.

This warranty gives you specific legal rights, and you may also have other rights which vary from state to state or province to province.

For warranty service or repair, contact your installing contractor. You may find the installer's name on the equipment or in your Owner's packet.

Complete product registration below and send back by e-mail at service@twclimate.com

PRODUCT REGISTRATION

Model No. _____

Serial No. _____ Date of Installation _____

Owner Name _____

Address of Installation _____

Installing Contractor _____

Address _____

Phone No. / E-mail _____