

INSTALLATION MANUAL

SPLIT SYSTEM

Air Conditioners

MODEL

**RZQ18TAVJUA
RZQ24TAVJUA
RZQ30TAVJUA
RZQ36TAVJUA
RZQ42TAVJUA
RZQ48TAVJUA**

**RZR18TAVJUA
RZR24TAVJUA
RZR30TAVJUA
RZR36TAVJUA
RZR42TAVJUA
RZR48TAVJUA**

English

Français

Español

Read these instructions carefully before installation.
Keep this manual in a handy place for future reference.
This manual should be left with the equipment owner.

Lire soigneusement ces instructions avant l'installation.
Conserver ce manuel à portée de main pour référence ultérieure.
Ce manuel doit être donné au propriétaire de l'équipement.

Lea cuidadosamente estas instrucciones antes de instalar.
Guarde este manual en un lugar a mano para leer en caso de
tener alguna duda.
Este manual debe permanecer con el propietario del equipo.

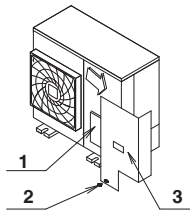

figure 1

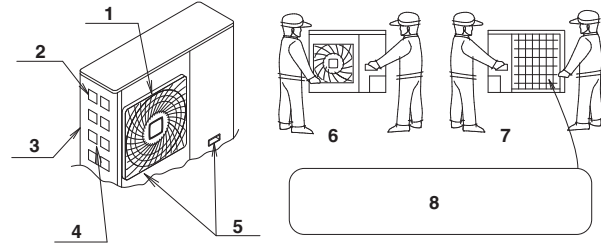

figure 2

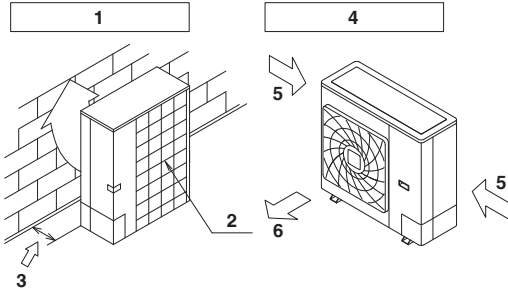

figure 3

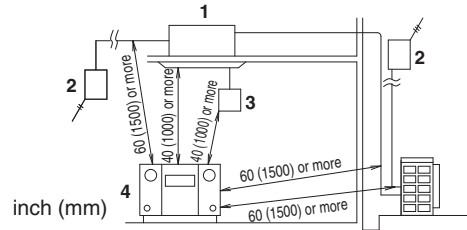

figure 4

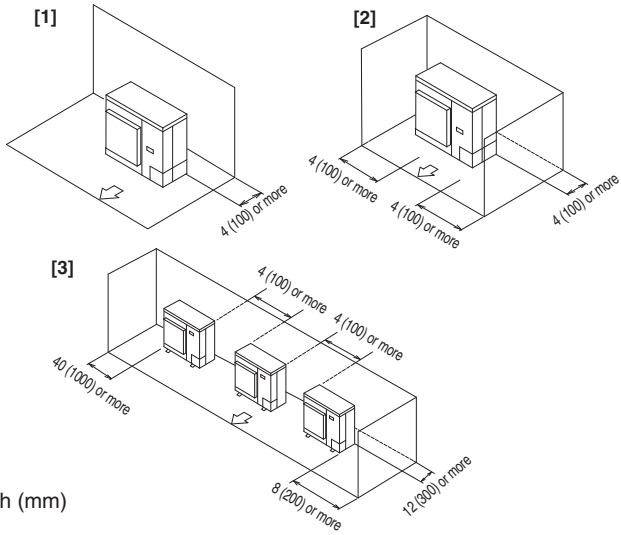

figure 5

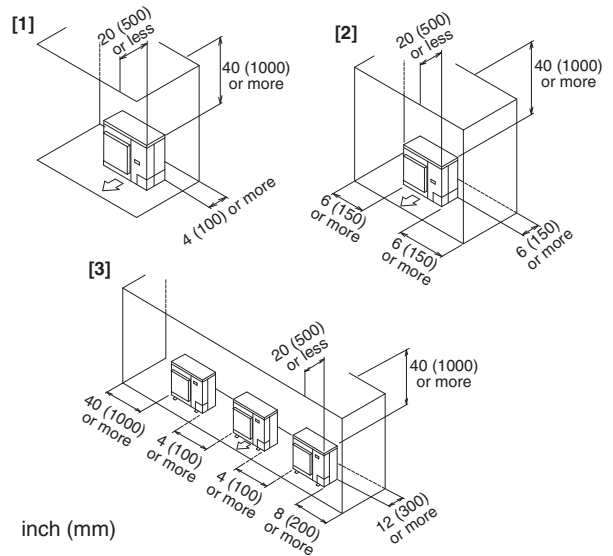

figure 6

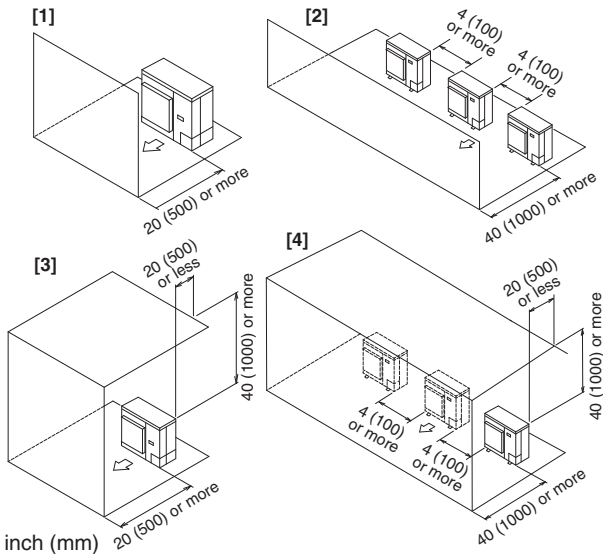

figure 7

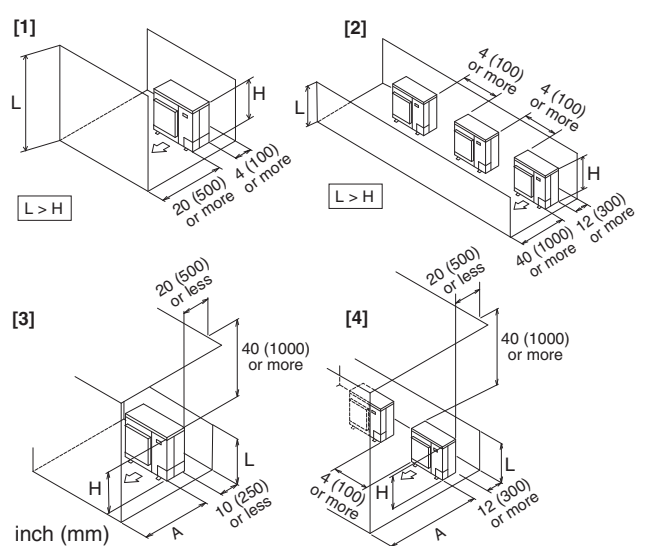

figure 8

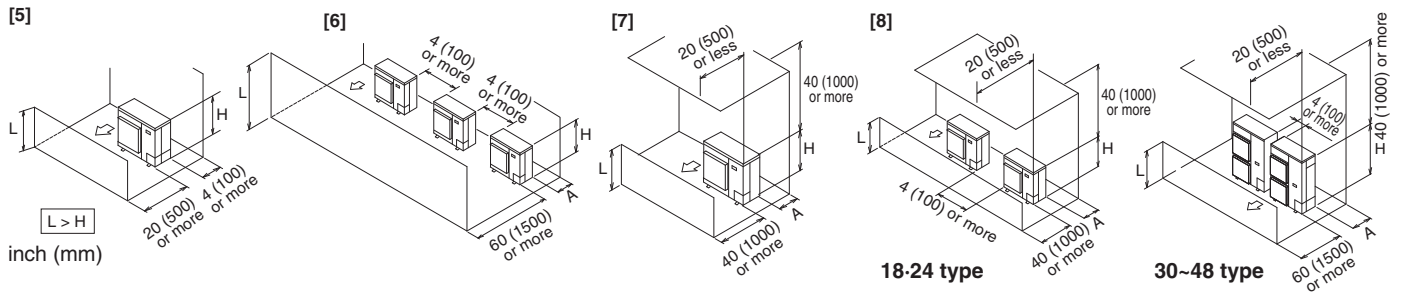

figure 8

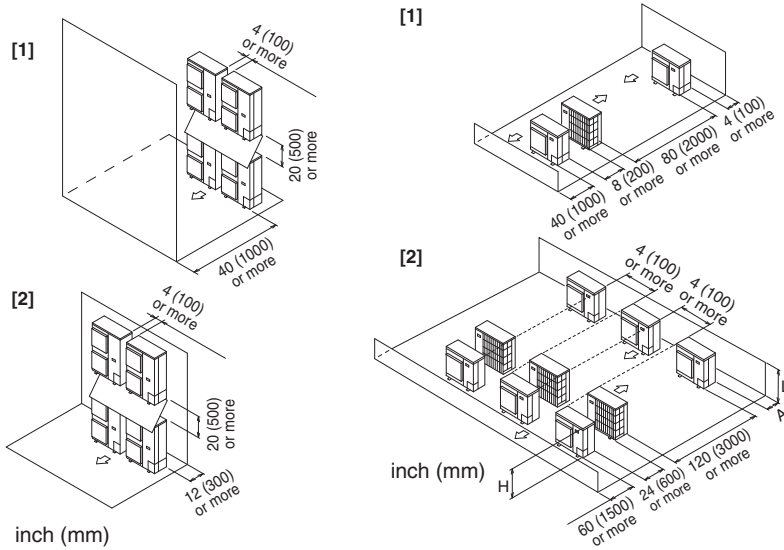

figure 9

figure 10

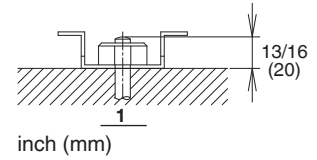

figure 11

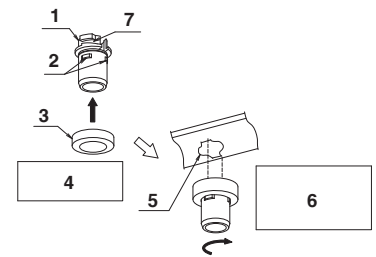

figure 12

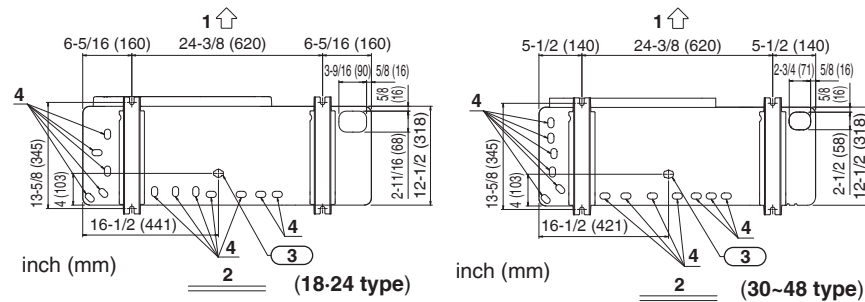

figure 13

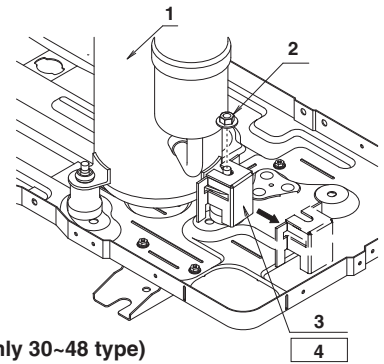

figure 14

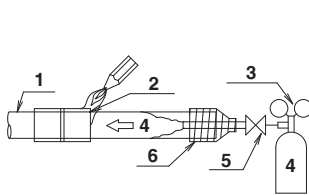

figure 15

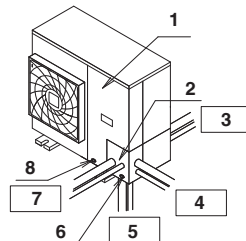

figure 16

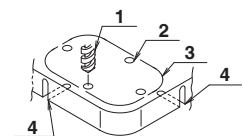

figure 17

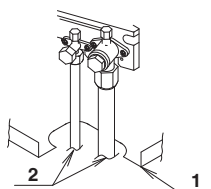

figure 18

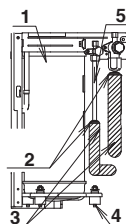

figure 19

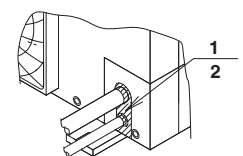

figure 20

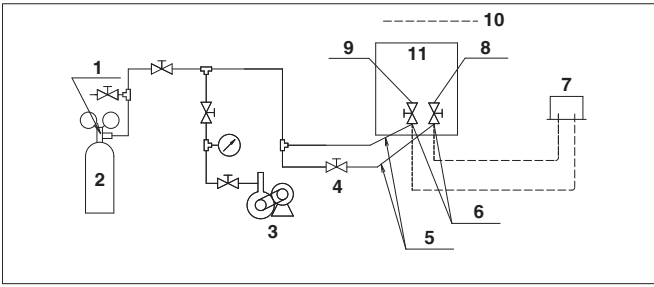

figure 21

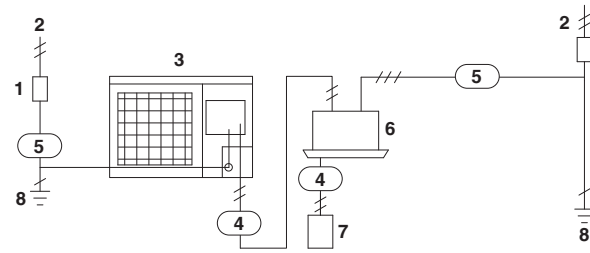

figure 22

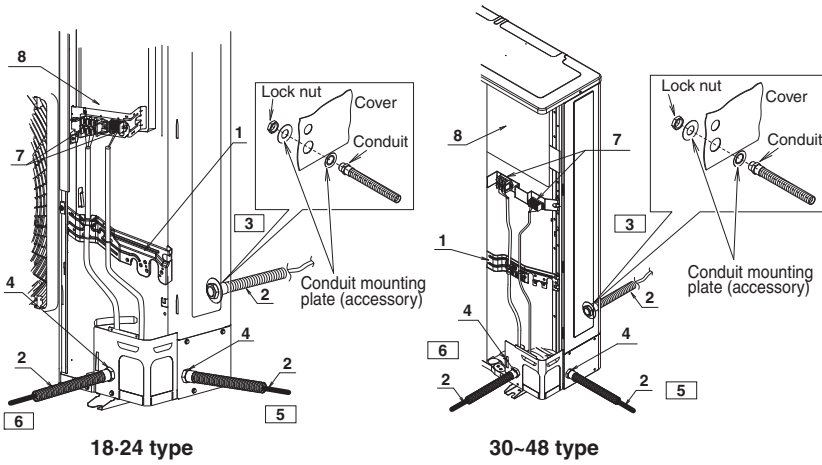

figure 23

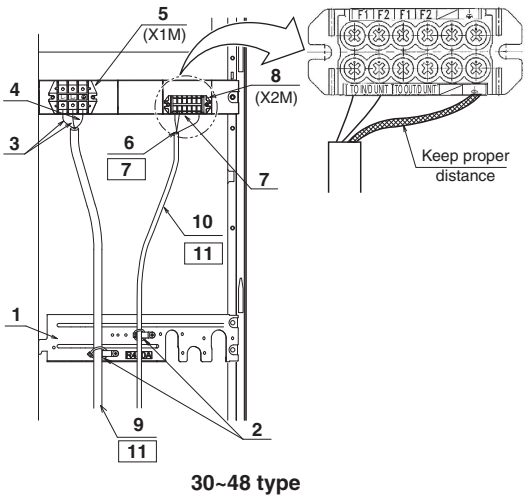
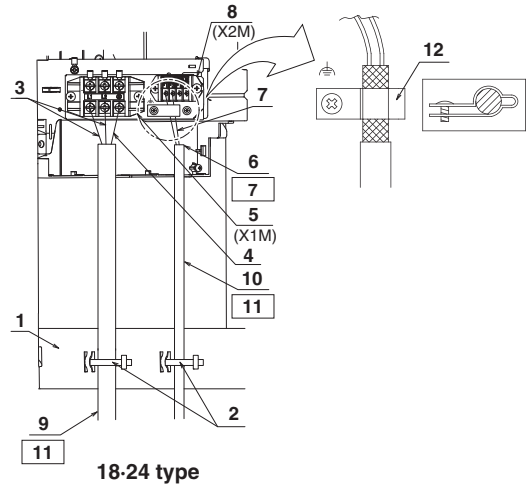

figure 25

figure 24

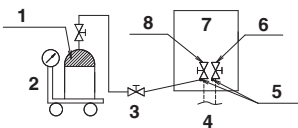

figure 26

CONTENTS

1. SAFETY CONSIDERATIONS	1
2. INTRODUCTION	2
2-1. Standard operation limit	3
2-2. Standard supplied accessories	3
3. BEFORE INSTALLATION	3
4. SELECTING INSTALLATION SITE	3
5. PRECAUTIONS ON INSTALLATION	5
6. REFRIGERANT PIPING	6
6-1. Installation tools	6
6-2. Selecting piping material	6
6-3. Protection against contamination when installing pipes	6
6-4. Pipe connection	6
6-5. Connecting the refrigerant piping	6
6-6. Thermal insulation of piping	7
6-7. Air tight test and vacuum drying	7
7. ELECTRIC WIRING	8
7-1. Wiring connection example for whole system	8
7-2. How to lay the power supply wiring and transmission wiring	9
7-3. How to connect the power supply wiring	9
7-4. Transmission wiring connection procedure	10
8. ADDITIONAL REFRIGERANT CHARGE	10
8-1. Before adding refrigerant	10
8-2. Checking the refrigerant tank	10
8-3. Adding refrigerant	10
9. POST-WORK CHECKS	11
10. TEST OPERATION	11
10-1. Power On—Check Operation	11
10-2. Temperature control operation checklist	12
10-3. Final refrigerant charge adjustment	12
11. ENERGY SAVING AND OPTIMUM OPERATION	12
11-1. Three main operation methods are available:	13
11-2. Several comfort settings are available	13
11-3. Setting of Heat Pump Lockout and Emergency Heat Mode	15
12. CAUTION FOR REFRIGERANT LEAKS	17

1. SAFETY CONSIDERATIONS

Read these "SAFETY CONSIDERATIONS for Installation" carefully before installing air conditioning equipment. After completing the installation, make sure that the unit operates properly during the startup operation. Instruct the customer on how to operate and maintain the unit. Inform customers that they should store this Installation Manual for future reference.

Always use a licensed installer or contractor to install this product. Improper installation can result in water or refrigerant leakage, electrical shock, fire, or explosion.

Meanings of **DANGER**, **WARNING**, **CAUTION**, and **NOTE** Symbols:

 **DANGER** Indicates an imminently hazardous situation which, if not avoided, will result in death or serious injury.

 **WARNING** Indicates a potentially hazardous situation which, if not avoided, could result in death or serious injury.

 **CAUTION** Indicates a potentially hazardous situation which, if not avoided, may result in minor or moderate injury. It may also be used to alert against unsafe practices.

 **NOTE** Indicates situations that may result in equipment or property damage accidents only.

DANGER

- Refrigerant gas is heavier than air and replaces oxygen. A massive leak can lead to oxygen depletion, especially in basements, and an asphyxiation hazard could occur leading to serious injury or death.
- Do not ground units to water pipes, gas pipes, telephone wires, or lightning rods as incomplete grounding can cause a severe shock hazard resulting in severe injury or death. Additionally, grounding to gas pipes could cause a gas leak and potential explosion causing in severe injury or death.
- If refrigerant gas leaks during installation, ventilate the area immediately. Refrigerant gas may produce toxic gas if it comes into contact with fire. Exposure to this gas could cause severe injury or death.
- After completing the installation work, check that the refrigerant gas does not leak throughout the system.
- Do not install unit in an area where flammable materials are present due to risk of explosions that can cause serious injury or death.
- Safely dispose of all packing and transportation materials in accordance with federal/state/local laws or ordinances. Packing materials such as nails and other metal or wood parts, including plastic packing materials used for transportation may cause injuries or death by suffocation.

WARNING

- Only qualified personnel must carry out the installation work. Installation must be done in accordance with this installation manual. Improper installation may result in water leakage, electric shock, or fire.
- When installing the unit in a small room, take measures to keep the refrigerant concentration from exceeding allowable safety limits. Excessive refrigerant leaks, in the event of an accident in a closed ambient space, can lead to oxygen deficiency.
- Use only specified accessories and parts for installation work. Failure to use specified parts may result in water leakage, electric shocks, fire, or the unit falling.
- Install the air conditioner or heat pump on a foundation strong enough that it can withstand the weight of the unit. A foundation of insufficient strength may result in the unit falling and causing injuries.
- Take into account strong winds, typhoons, or earthquakes when installing. Improper installation may result in the unit falling and causing accidents.
- Make sure that a separate power supply circuit is provided for this unit and that all electrical work is carried out by qualified personnel according to local, state and national regulations. An insufficient power supply capacity or improper electrical construction may lead to electric shocks or fire.
- Make sure that all wiring is secured, that specified wires are used, and that no external forces act on the terminal connections or wires. Improper connections or installation may result in fire.
- Before touching electrical parts, turn off the unit.
- This equipment can be installed with a Ground-Fault Circuit Interrupter (GFCI). Although this is a recognized measure for additional protection, with the grounding system in North America, a dedicated GFCI is not necessary.

- When installing or relocating the system, keep the refrigerant circuit free from substances other than the specified refrigerant (R410A) such as air. Any presence of air or other foreign substance in the refrigerant circuit can cause an abnormal pressure rise or rupture, resulting in injury.
- Do not change the setting of the protection devices. If the pressure switch, thermal switch, or other protection device is shorted and operated forcibly, or parts other than those specified by Daikin are used, fire or explosion may occur.



CAUTION

- Do not touch the switch with wet fingers. Touching a switch with wet fingers can cause electric shock.
- Do not allow children to play on or around the unit to prevent injury.
- Do not touch the refrigerant pipes during and immediately after operation as the refrigerant pipes may be hot or cold, depending on the condition of the refrigerant flowing through the refrigerant piping, compressor, and other refrigerant cycle parts. It may result in your hands getting burns or frostbite if you touch the refrigerant pipes.
To avoid injury, give the pipes time to return to normal temperature or, if you must touch them, be sure to wear proper gloves.
- The heat exchanger fins are sharp enough to cut, and can cause injury if improperly used. To avoid injury, wear gloves or cover the fins when working around them.
- Insulate piping to prevent condensation.
- Be careful when transporting the product.
- Do not turn off the power immediately after stopping operation. Always wait for at least 5 minutes before turning off the power. Otherwise, water leakage may occur.
- Do not use a charging cylinder. Using a charging cylinder may cause the refrigerant to deteriorate.
- Refrigerant R410A in the system must be kept clean, dry, and tight.
 - (a) Clean and Dry - Foreign materials (including mineral oils such as SUNISO oil or moisture) should be prevented from getting into the system.
 - (b) Tight - R410A does not contain any chlorine, does not destroy the ozone layer, and does not reduce the earth's protection against harmful ultraviolet radiation.
R410A can contribute to the greenhouse effect if it is released. Therefore take proper measures to check for the tightness of the refrigerant piping installation.
Read the chapter Refrigerant Piping and follow the procedures.
- Since R410A is a blend, the required additional refrigerant must be charged in its liquid state. If the refrigerant is charged in a gaseous state, its composition can change and the system will not work properly.
- The indoor unit is for R410A. See the catalog for indoor models that can be connected. Normal operation is not possible when connected to other units.
- Remote controller transmitting distance can be shorter than expected in rooms with electronic fluorescent lamps (inverter or rapid start types). Install the indoor unit far away from fluorescent lamps as much as possible.
- Indoor units are for indoor installation only. Outdoor units can be installed either outdoors or indoors. This unit is for outdoor use.

- Do not install the air conditioner or heat pump in the following locations:
 - (a) Where a mineral oil mist or oil spray or vapor is produced, for example, in a kitchen.
Plastic parts may deteriorate and fall off or result in water leakage.
 - (b) Where corrosive gas, such as sulfurous acid gas, is produced.
Corroding copper pipes or soldered parts may result in refrigerant leakage.
 - (c) Near machinery emitting electromagnetic waves.
Electromagnetic waves may disturb the operation of the control system and cause the unit to malfunction.
 - (d) Where flammable gas may leak, where there is carbon fiber, or ignitable dust suspension in the air, or where volatile flammables such as thinner or gasoline are handled. Operating the unit in such conditions can cause a fire.
- Take adequate measures to prevent the outdoor unit from being used as a shelter by small animals. Small animals making contact with electrical parts can cause malfunctions, smoke, or fire. Instruct the customer to keep the area around the unit clean.



NOTE

- Install the power supply and transmission wires for the indoor and outdoor units at least 3.5 ft. (1 m) away from televisions or radios to prevent image interference or noise.
Depending on the radio waves, a distance of 3.5 ft. (1 m) may not be sufficient to eliminate the noise.
- Dismantling the unit, treatment of the refrigerant, oil and additional parts must be done in accordance with the relevant local, state, and national regulations.
- Do not use the following tools that are used with conventional refrigerants: gauge manifold, charge hose, gas leak detector, reverse flow check valve, refrigerant charge base, vacuum gauge, or refrigerant recovery equipment.
- If the conventional refrigerant and refrigerant oil are mixed in R410A, the refrigerant may deteriorate.
- This air conditioner or heat pump is an appliance that should not be accessible to the general public.
- As design pressure is 478 psi (3.3 MPa), the wall thickness of field-installed pipes should be selected in accordance with the relevant local, state, and national regulations.

Codes and Regulations

This product is designed and manufactured to comply with national codes. Installation in accordance with such codes and/or prevailing local codes/regulations is the responsibility of the installer. The manufacturer assumes no responsibility for equipment installed in violation of any codes or regulations. Rated performance is achieved after 72 hours of operation.

2. INTRODUCTION

1. This series uses R410A refrigerant. Be absolutely sure to comply with "6. REFRIGERANT PIPING", because even greater caution is needed to prevent impurities from entering R410A (mineral oils and water).
2. The design pressure is 478psi (3.3MPa), which means that piping may be thicker than conventionally, so please refer to "6. REFRIGERANT PIPING".
3. This is a mixed refrigerant, so charge as a liquid when adding refrigerant. (If charged as a gas, the composition of the refrigerant may change, preventing normal operation.)
4. The indoor unit must use R410A. See the catalog for indoor unit models which can be connected. (Normal operation is not possible when connected to other units.)
5. The power supply of this series is single-phase, 208/230V, 60Hz.

2-1 Standard operation limit

Normal operation

The figures below assume following operating conditions for indoor and outdoor units:

Equivalent pipe length 25 ft. (7.6 m)
 Level difference 0 ft. (0 m)

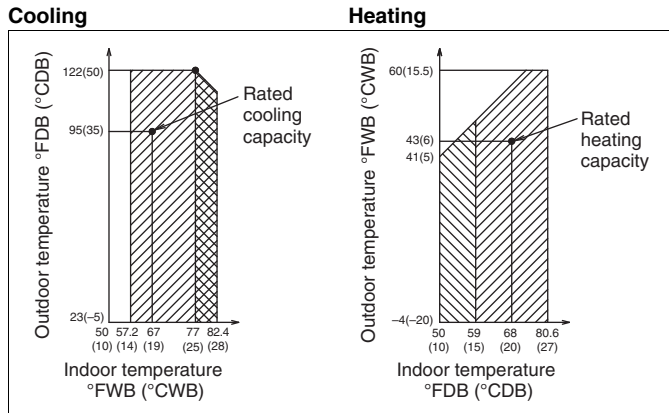

- Range for operation
- Range for pull down operation
- Range for warming up operation

2-2 Standard supplied accessories

Make sure that the accessories shown below are all present.
 (The accessories can be found behind the front panel.)

Name	Clamp	Conduit mounting plate		Wire clamp and screw
Quantity	4 pcs.	2 pcs.	2 pcs.	1 (only 18-24 type)
Shape				

Name	Insulation tube		Installation manual	Warranty card
Quantity	1 pc.	1 pc.	1	1
Shape				
	(Large)	(Small)		

(Refer to figure 1)

1. Accessories
2. Screw for front panel
3. Front panel

3. BEFORE INSTALLATION

<Transporting the unit>

As shown in figure 2, move the unit slowly. (Take care not to let hands or other objects come in contact with rear fins.)

(Refer to figure 2)

1. Air outlet grille
2. Intake hole
3. Corner
4. Outdoor unit
5. Handle
6. Front
7. Rear
8. Always hold the unit by the corners, as holding it by the side intake holes on the casing may cause them to deform.

Use only accessories and parts which are of the designated specification when installing.

4. SELECTING INSTALLATION SITE

(1) Select an installation site where the following conditions are satisfied and that meets with your customer's approval.

- Places which are well-ventilated.
- Places where the unit does not bother next-door neighbors.
- A location where small animals will not make nests in the unit.
- Safe places which can withstand the unit's weight and vibration and where the unit can be installed level.
- A locations where there is enough space to install the unit.
- Places where the indoor and outdoor unit's piping and wiring lengths come within the allowable ranges.
- A location where there is no risk of flammable gas leaking.

(2) If the unit is installed in a location where it might be exposed to strong wind, install as per figure 3.

- 11 mph (5 m/s) or higher winds blown against the outdoor unit's exhaust cause a deterioration in the system performance. High winds force re-circulation of the exhaust air into the inlet, which is known to cause the following effects:
 - Reduction in performance.
 - Increased frost formation in heating mode.
 - System shut down due to increased pressures.
- If very strong wind blows continuously on the air outlet side of the outdoor unit, the fan may turn in reverse at high speed and break, so install as per figure 3.

(Refer to figure 3)

1. Turn the air outlet side toward the building's wall, fence or windbreak screen.
2. Air inlet grille
3. Ensure there is enough space for installing the unit.
4. Set the outlet side at a right angle to the direction of the wind.
5. Strong wind
6. Blown air

(3) When installing the unit in a place frequently exposed to snow, pay special attention to the following:

- Install the outdoor unit on a stand (field supply), so that the bottom frame is more than 20 in. (500 mm) higher than the expected snow fall to prevent it from being covered by snow.
- Attach a snow hood (field supply) and a snow vizor (field supply).
- Avoid installation at the place where a snowdrift is generated.
- Further, perform the following countermeasures, since there is risk that the drain water produced at the defrost operation freezes.
- Install the outdoor unit so that its bottom place level has a sufficient height from foundation level, so that ice does not grow at the lower surface of the bottom place of the outdoor unit. (Recommended clearance: 20 in. (500 mm) or more)

- In areas where the outside air temperature drops below 32°F (0°C) for more than 12 hours continuously, install a drain-pan heater (optional accessory) on the bottom frame to prevent the drain from freezing.
- An optional drain pan heater is available when the unit is installed in a climate where the drain may freeze.
- The installer should use their local knowledge to determine if this accessory is necessary to prevent the drain from freezing.
- Do not use a concentrated drain plug (field supply). (If a drain plug and/or drain pipe are/is used, there is a risk of freezing.)
- If there is a problem with drain dripping from the bottom frame drain, set up a roof (field supply) below the outdoor unit, or enact other countermeasures.
- Remove the rear inlet grille to prevent snow from accumulating on the rear fins.

(4) When there is possibility of short-circuit depending on the ambient situation, use the wind direction adjusting plate (optional accessory).

(5) The refrigerant gas (R410A) is a safe, non-toxic and non-flammable gas, but if it leaks into the room, the concentration may exceed tolerance levels, especially in small rooms, so steps need to be taken to prevent refrigerant leakage. See the equipment design reference for details.

(6) Inverter-type air conditioners sometimes cause static in other electrical appliances.

When selecting an installation location, make sure the air conditioner and all wiring are sufficiently far away from radios, computers, stereos, and other appliances, as shown in figure 4.

Particularly for locations with weak reception, ensure there is a distance of at least 9.8 ft. (3 m) for indoor remote controllers, place power supply wiring and transmission wiring in conduits, and ground the conduits. Use non-shielded wire for transmission wiring.

(Refer to figure 4)

1. Indoor unit
2. Fuse/Breaker
3. Remote controller
4. Personal computer or radio

(7) Space needed for installation

<Precautions when installing units in series>

- The direction for field piping is either forward or down when installing units in series, as shown in the figure (5-10).
- If the piping is brought out from the back, the outdoor unit will require at least 10 in. (250 mm) from its right side.

(7)-1 IN CASE OBSTACLES EXIST ONLY IN FRONT OF THE AIR INLET

When nothing is obstructing the top

1. Installation of single unit
 - In case obstacles exist only in front of the air inlet **(Refer to figure 5-[1])**
 - In case obstacles exist in front of the air inlet and on both sides of the unit **(Refer to figure 5-[2])**
2. In case of installing multiple units (2 units or more) in lateral connection per row
 - In case obstacles exist in front of the air inlet and on both sides of the unit **(Refer to figure 5-[3])**

When something is obstructing the top

1. Installation of single unit
 - In case obstacles exist only in front of the air inlet **(Refer to figure 6-[1])**
 - In case obstacles exist in front of the air inlet and on both sides of the unit **(Refer to figure 6-[2])**
2. In case of installing multiple units (2 units or more) in lateral connection per row
 - In case obstacles exist in front of the air inlet and on both sides of the unit **(Refer to figure 6-[3])**

(7)-2 IN CASE OBSTACLES EXIST IN FRONT OF THE OUTLET SIDE

When nothing is obstructing the top

1. Installation of single unit **(Refer to figure 7-[1])**
2. In case of installing multiple units (2 units or more) in lateral connection per row **(Refer to figure 7-[2])**

When something is obstructing the top

1. Installation of single unit **(Refer to figure 7-[3])**
2. In case of installing multiple units (2 units or more) in lateral connection per row **(Refer to figure 7-[4])**

(7)-3 IN CASE OBSTACLES EXIST IN FRONT OF BOTH THE AIR INLET AND OUTLET SIDES

Pattern 1: Where obstacle in front of the air outlet is higher than the unit.

(There is no height limit for obstructions on the intake side.)

When nothing is obstructing the top

1. Installation of single unit **(Refer to figure 8-[1])**
2. In case of installing multiple units (2 units or more) in lateral connection per row **(Refer to figure 8-[2])**

When something is obstructing the top

1. Installation of single unit **(Refer to figure 8-[3])**

Relation of dimensions of H, A, and L are shown in the table below.
inch (mm)

	L	A
L ≤ H	0 < L ≤ 1/2H	30 (750)
	1/2H < L ≤ H	40 (1000)
H < L	Set the frame to be L ≤ H	

Note)

Close the area under the frame so the outlet air does not bypass there.

2. Series installation (up to two units) **(Refer to figure 8-[4])**

Relation of dimensions of H, A, and L are shown in the table below.
inch (mm)

	L	A
L ≤ H	0 < L ≤ 1/2H	40 (1000)
	1/2H < L ≤ H	50 (1250)
H < L	Set the frame to be L ≤ H	

Note)

1. Close the area under the frame so the outlet air does not bypass there.
2. No more than two units can be installed in series.

Pattern 2: Where obstacles in front of the air outlet is lower than the unit.

(There is no height limit for obstructions on the intake side.)

When nothing is obstructing the top

1. Installation of single unit **(Refer to figure 8-[5])**
2. In case of installing multiple units (2 units or more) in lateral connection per row **(Refer to figure 8-[6])**

Relation of dimensions of H, A, and L are shown in the table below.
inch (mm)

	L	A
	0 < L ≤ 1/2H	10 (250)
	1/2H < L ≤ H	12 (300)

When something is obstructing the top

1. Installation of single unit (Refer to figure 8-[7])

Relation of dimensions of H, A, and L are shown in the table below.
inch (mm)

	L	A
L ≤ H	0 < L ≤ 1/2H	4 (100)
	1/2H < L ≤ H	8 (200)
H < L	Set the frame to be L ≤ H	

Note)

Get the lower part of the frame sealed so that air from the outlet does not bypass.

2. Series installation (up to two units) (Refer to figure 8-[8])

Relation of dimensions of H, A, and L are shown in the table below.
inch (mm)

	L	A
L ≤ H	0 < L ≤ 1/2H	10 (250)
	1/2H < L ≤ H	12 (300)
H < L	Set the frame to be L ≤ H	

Note)

- Get the lower part of the frame sealed so that air from the outlet does not bypass.
- Only two units at most can be installed in series.

(7)-4 IN CASE OF STACKED INSTALLATION

(1) In case obstacles exist in front of the outlet side

(Refer to figure 9-[1])

(2) In case obstacles exist in front of the air inlet (Refer to figure 9-[2])

Note)

- No more than two units should be stacked.
- If there is a danger of water from the drain falling on the lower outdoor unit and freezing, install a roof (field supply) as shown in the figure 9.
- To prevent the formation and growth of ice in the bottom frame of the 2nd level outdoor unit, install the outdoor unit so that the bottom frame will be sufficiently higher than the roof. (It is recommended to leave 19.6 in. (500 mm) or more)
- About 4 in. (100 mm) is required as the dimension for laying the upper outdoor unit's drain pipe.
- Shut off the Z part (the area between the upper outdoor unit and the lower outdoor unit) so that outlet air does not bypass.

(7)-5 IN CASE OF MULTIPLE-ROW INSTALLATION (FOR ROOF TOP USE, ETC.)

1. In case of installing one unit per row (Refer to figure 10-[1])

2. In case of installing multiple units (2 units or more) in lateral connection per row (Refer to figure 10-[2])

Relation of dimensions of H, A, and L are shown in the table below.
inch (mm)

	L	A
L ≤ H	0 < L ≤ 1/2H	10 (250)
	1/2H < L ≤ H	12 (300)
H < L	Installation impossible.	

5. PRECAUTIONS ON INSTALLATION

- Before installation, make sure the unit is level and the foundation is sturdy enough to prevent vibration and noise.
- Fasten the unit in place using 4 foundation bolts M12 or equivalent. It is best to screw in the foundation bolt until their length remains 13/16 in. (20 mm) above the foundation surface.

(Refer to figure 11)

- Diagram of lower surface

<Drain pipe installation>

- Locations where drain water from the outdoor unit might be a problem.

In such locations, for example, where the drain water might drip onto passersby, lay the drain pipe using the separately sold drain plug and seal up the drain holes in the bottom frame. For details, please contact your dealer.

In case of installing the outdoor unit in cold climates, do not take this centralized drainage way. Otherwise, drain pipe freeze-up and ice build-up on the bottom frame way occur.

- When laying the drain pipe, at least 4 in. (100 mm) from the bottom of the outdoor unit is needed.
- Make sure the drainage works properly.
(Watch out for water leaks if piping is brought out the bottom.)

(Refer to figure 12)

- Drain plug
- 4 tabs
- Drain receiver
- Insert the drain receiver into the drain plug and hook the tabs.
- Bottom frame drain hole
- (1) Insert the drain plug through the drain hole in the bottom frame shown in figure 13.
(2) Turn the drain plug along the guides until it stops (approx. 40°).
- Guide

(Refer to figure 13)

- Air outlet side
- Diagram of lower surface
- Drain hole (For plug)
- Drain hole

[How to remove the transport bracket] (30-36-42-48 type)

- A yellow transport bracket and washer are attached to the leg of the compressor to protect the unit during transportation, so remove them as shown in figure 14.

(Refer to figure 14)

- Compressor
- Securing nut
- Transport bracket (Yellow)
- Turn in the direction of the arrow and remove.

(1) Open the sound-proof cover as shown in figure 14.

Do not pull the sound-proof cover or remove it from the compressor.

(2) Remove the securing nut.

(3) Remove the washer.

(4) Remove the transport bracket as shown in figure 14.

(5) Retighten the securing nut.

(6) Return the sound-proof cover as it was.

6. REFRIGERANT PIPING



CAUTION

- Do not allow anything other than the designated refrigerant to get mixed into the refrigerant cycle, such as air, nitrogen, etc. If any refrigerant gas leaks while working on the unit, ventilate the room thoroughly right away.
- Use R410A only when adding refrigerant.

6-1 Installation tools

Make sure to use speciality tools to withstand the pressure and to prevent foreign materials from mixing into the system.

Gauge manifold Charge hose	<ul style="list-style-type: none"> Make sure to use installation tools that are exclusively made for R410A installations to withstand the pressure and to prevent foreign materials (e.g. mineral oils such as SUNISO and moisture) from mixing into the system.
Vacuum pump	<ul style="list-style-type: none"> Use a 2-stage vacuum pump with a non-return valve. Make sure the pump oil does not flow backward into the system while the pump is not working. Use a vacuum pump which can evacuate to 500 microns.

6-2 Selecting piping material



CAUTION

Piping and other pressure containing parts shall comply with the applicable legislation and shall be suitable for refrigerant. Use phosphoric acid deoxidized seamless copper for refrigerant.



CAUTION

- All field piping must be installed by a licensed refrigeration technician and must comply with relevant local and national regulations.
- After piping work is complete, do not under any circumstances open the stop valve until **7. ELECTRIC WIRING** on page 8 and **9. POST-WORK CHECKS** on page 11 are complete.
- Do not use flux when brazing the refrigerant piping. Use the phosphor copper brazing filler metal (B-Cu93P-710/795:ISO 3677) which does not require flux. Flux has extremely negative effect on refrigerant piping systems. For instance, if the chlorine based flux is used, it will cause pipe corrosion or, in particular, if the flux contains fluorine, it will damage the refrigerant oil.
- Use only pipes which are clean inside and outside and which do not accumulate harmful sulfur, oxidants, dirt, cutting oils, moisture, or other contamination. (Foreign materials inside pipes including oils for fabrication must be 0.14 gr/10 ft. (30 mg/10 m) or less.)
- Use the following items for the refrigerant piping.

Material: Jointless phosphor-deoxidized copper pipe.

Thickness: Select a thickness for the refrigerant piping which complies with national and local laws.
- Maximum piping length and height difference between the outdoor and indoor units.

Model	18-24 type	30~48 type
Maximum piping length	164 ft. (50 m)	230 ft. (70 m)
Maximum height difference	98 ft. (30 m) (outdoor unit above indoor unit)	98 ft. (30 m) (outdoor unit below indoor unit)

6-3 Protection against contamination when installing pipes

- Cover the ends of pipe to prevent moisture, dirt, dust, etc. from entering the piping.
- Exercise caution when passing copper piping through the through-holes and when passing them out to the outside.

Place	Installation	Protection method
	More than a month	Pinch the pipe
	Less than a month	Pinch or tape the pipe
	Regardless of the period	

6-4 Pipe connection

- See “Stop valve operation procedure” in “**6-7 Air tight test and vacuum drying**” regarding handling of the stop valve.
- Only use the flare nuts included with the unit. Using different flare nuts may cause the refrigerant to leak.
- Be sure to perform a nitrogen blow when brazing.** (Brazing without performing nitrogen replacement or releasing nitrogen into the piping will create large quantities of oxidized film on the inside of the pipes, adversely affecting valves and compressors in the refrigerating system and preventing normal operation.)

(Refer to figure 15)

- Refrigerant pipe
- Location to be brazed
- Regulator
- Nitrogen
- Manual valve
- Taping

6-5 Connecting the refrigerant piping

- Connection to larger pipe sizes.

In certain configurations this system is designed to be connected to larger diameter pipe sizes than the standard factory service valves. If the installation requires use of larger pipe diameters, a field setting change is required for the system to operate smoothly.
- The local field piping is connectable in four directions.

(Refer to figure 16)

- Front panel
- Pipe outlet panel
- Backward
- Sideways
- Downward
- Pipe outlet panel screw
- Forward
- Screw for front panel

- When connecting the pipings downward, remove the knockout by making four holes in the middle on the each side of the knockout with a drill.**

(Refer to figure 17)

- Drill
- Center area around knockout
- Knockout
- Slit

- After knocking out the knockout, it is recommended to apply repair paint to the edge and the surrounding end surfaces to prevent rusting.

(Refer to figure 18)

- Bottom frame
- Field piping

<Precautions when connecting pipes>

- Please refer to the Table 1 for the dimensions for processing flares.
- When connecting the flare nut, coat the flare both inside and outside with refrigerating unit oil and initially tighten by hand 3 or 4 turns before tightening firmly.
- Please refer to the Table 1 for the tightening torque. (Too much tightening will end up in splitting of the flare.)

Table 1

Pipe size (in.)	Tightening torque (ft-lbf)	A dimensions for processing flares (in.)	Flare shape (in.)
φ3/8" (9.5 mm)	24.1~29.4 (32.7~39.9 N·m)	0.504~0.520 (12.8~13.2 mm)	
φ5/8" (15.9 mm)	45.6~55.6 (61.8~75.4 N·m)	0.760~0.776 (19.3~19.7 mm)	

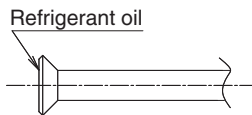

- After all the piping has been connected, use nitrogen to perform a gas leak check.

Precautions for connecting pipes

- Be careful not to let the field piping come into contact with the compressor terminal cover.

Adjust the height of the insulation material on liquid pipe when it has the possibility of getting in contact with the terminal. Also make sure that the field piping does not touch the mounting bolt of the compressor.

(Refer to figure 19)

- Compressor
 - Corking, etc.
 - Insulation material
 - Bolts
 - Field piping
- If installing the outdoor unit higher than the indoor unit, caulk the space around insulation and tubes because condensation on the check valve can seep through to the indoor unit side.

[Preventing foreign objects from entering]

- Plug the pipe through-holes with putty or insulating material (procured locally) to stop up all gaps, as shown in figure 20. (Figure 20 indicates the forward case. Do the same in case of other directions.) Insects or small animals entering the outdoor unit may cause a short in the control box.

(Refer to figure 20)

- Putty or insulating material
- (field supply)

6-6 Thermal insulation of piping

- Insulate the field piping (liquid and gas-side). (Not insulating them may cause leaking.)
- The insulation dimension is recommended as following:

Ambient temperature: 86°F (30°C), humidity: Below 80% RH	Ambient temperature: 86°F (30°C), humidity: 80% RH and above
Minimum thickness: 9/16 inch (15 mm)	Minimum thickness: 3/4 inch (20 mm)

- When using commercial copper pipes and fittings, observe the following:
 - Insulation of pipes should be done after performing air tight test and vacuum drying.
 - Heat transfer rate: 0.024 to 0.030 BTU/fth°F (0.041 to 0.052 W/Mk (0.035 to 0.045 kcal/mh°C))
 - Be sure to use insulation that is designed for use with HVAC Systems.
 - The highest temperature that the gas-side piping can reach is around 248°F (120°C), so be sure to use insulating material which is sufficiently resistant to this temperature.



CAUTION

For local insulation, be sure to insulate all the way to the pipe connections inside the unit.

Exposed piping may cause leaks or burns on contact.

6-7 Air tight test and vacuum drying

After doing the piping, perform the following inspections.

Air tight test

Be sure to use nitrogen gas. (See the figure ("Stop valve operation procedure") for the location of the service port.)

[Procedure]

Pressurize from the liquid pipes and gas pipes to 550 psi (3.8 MPa) (and not above 550 psi (3.8 MPa)). If there is not pressure drop over the next 24 hours, the equipment has passed the test.

If the pressure drops, check for leakage positions. (Confirm that there is no leakage, then release nitrogen.)

If a FTQ indoor unit is used, only pressurize to 450 psi (3.1 MPa).

Vacuum drying

Use a vacuum pump that can create a vacuum down to at least 500 microns.

[Procedure]

Operate the vacuum pump for **at least 2 hours** from **both the liquid and gas pipes** and decrease the pressure to at least 500 microns.

Leave at below 500 microns for at least 1 hour and make sure that the vacuum gauge does not rise. (If it does rise, there is either still moisture in the system or a leak.)

Cases where moisture might enter the piping (i.e., if doing work during the rainy season, if the actual work takes long enough that condensation may form on the inside of the pipes, if rain might enter the pipes during work, etc.)

After performing the vacuum drying for 2 hours, pressurize to 7.2 psi (0.05 MPa) (i.e., vacuum breakdown) with nitrogen gas, then depressurize down to at least 500 microns for an hour using the vacuum pump (vacuum drying). (If the pressure does not reach at least 500 microns even after depressurizing for at least 2 hours, repeat the vacuum breakdown - vacuum drying process.) Leave as a vacuum for 1 hour after that, and make sure the vacuum gauge does not rise.

(Refer to figure 21)

1. Decompression valve
2. Nitrogen
3. Vacuum pump
4. Valve (Open)
5. Charge hose
6. Stop valve service port
7. Indoor unit
8. Gas line stop valve (Close)
9. Liquid line stop valve (Close)
10. Indicates local procurement
11. Outdoor unit

NOTE

The stop valve must always be turned to “closed”. Otherwise the refrigerant in the outdoor unit will pour out.

Stop valve operation procedure

Precautions when handling the stop valve

- The names of parts needed to operate the stop valve are shown in the figure below. The unit is shipped from the factory with the stop valve turned to the “closed” position.

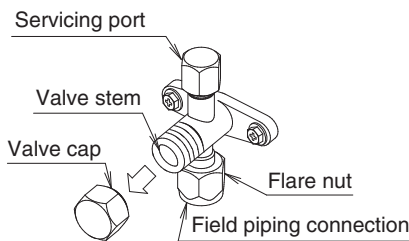

- Since the side boards may be deformed if only a torque wrench is used when loosening or tightening flare nuts, always lock the stop valve with a wrench and then use a torque wrench.
- In cases where the unit is run in heating mode when the outside temperature is low or in other situations where the operating pressure might drop, seal the gas-side flare nut on the stop valve with silicon sealant or the like to prevent it from freezing.

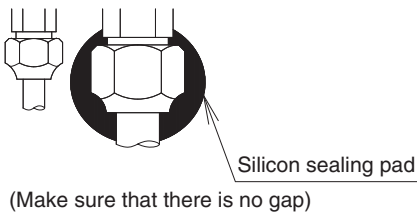

Stop valve operation procedure

Have a hex wrench ready (size: 0.2 in. (4 mm) and 0.3 in. (6 mm)).

Opening the valve

1. Place the hex wrench on the valve stem and turn counter-clockwise.
2. Stop when the valve stem no longer turns. It is now open.

Close the valve

1. Place the hex wrench on the valve stem and turn clockwise.
2. Stop when the valve stem no longer turns. It is now closed.

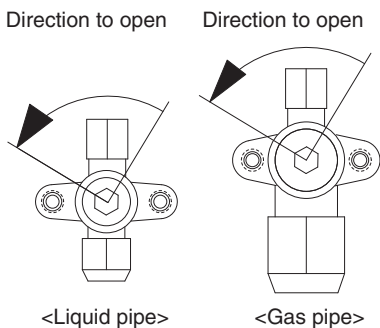

Precautions for handling valve cap

- A seal is attached to the point indicated by the arrow. Take care not to damage it.

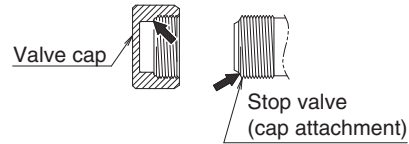

- Be sure to tighten the valve cap securely after operating the valves.

Liquid-side tightening torque	Gas-side tightening torque
10.0 ~ 12.2 ft-lbf (13.5 ~ 16.5 N-m)	16.6 ~ 20.3 ft-lbf (22.5 ~ 27.5 N-m)

Precautions for handling servicing port

- Use a push-rod-provided charging hose for operation.
- Be sure to tighten the valve cap securely after operation. Tightening torque 8.5 ~ 10.3 ft-lbf (10.8 ~ 14.7 N-m)

7. ELECTRIC WIRING

CAUTION

To the electrician

- Do not operate until refrigerant piping work is completed. (Failure to adhere by this caution may lead to irreparable compressor damage.)

7-1 Wiring connection example for whole system

- Electrical wiring work should be done by a certified professional.
- Follow the “Wiring diagram” label when carrying out any electrical wiring.
 - Only proceed with wiring work after turning off all power.
- Make sure the ground resistance is no greater than 4Ω.
- Ground the indoor and outdoor units.
- Do not connect the ground wire to gas pipes, sewage pipes, lightning rods, or telephone ground wires.
 - **Gas pipes:** can explode or catch fire if there is a gas leak.
 - **Sewage pipes:** no grounding effect is possible if hard plastic piping is used.
 - **Telephone ground wires and lightning rods:** dangerous when struck by lightning due to abnormal rise in electrical potential in the grounding.
- Use copper wire.
- When doing the electrical wiring, always shut off the power supply before working, and do not turn on the switch until all work is complete.
- This unit has an inverter, so it must be grounded in order to reduce noise and prevent it affecting other appliances, and also to release any electrical build-up in the unit case due to leaked current.
- Do not install a power-factor improving phase-advancing capacitor under any circumstances. (Not only will this not improve the power factor, but it might cause a fire.)
- Connect the wire securely using designated wire and fix it with attached clamp without applying external pressure on the terminal parts (terminal for power supply wiring, terminal for transmission wiring and ground terminal). See “7-3 How to connect the power supply wiring”.
- Leftover wiring should not be wrapped and stuffed into the unit.
- Secure the wiring with the included clamp so that it does not come in contact with the piping or stop valve. (See “7-3 How to connect the power supply wiring”.)

CAUTION

- Use a conduit for field wiring.
- Outside the unit, make sure the low voltage wiring (i.e. for the remote controller wire, between units, etc.) and the high voltage wiring do not pass near each other, **keeping them at least 2 in. (50 mm) apart**. Proximity may cause electrical interference, malfunctions, and breakage.
- Be sure to connect the power supply wiring to the power supply wiring terminal block and secure it as described in “7-3 How to connect the power supply wiring”.
- Transmission wiring should be secured as described in “7-4 Transmission wiring connection procedure”.
- Secure wiring with clamp (accessory) to avoid contact with piping.
- Make sure the wiring and the front panel do not stick up above the structure, and close the panel firmly.

(Refer to figure 22)

1. Fuse/Breaker
2. Power supply
3. Outdoor unit
4. 16V
5. 208/230V
6. Indoor unit
7. Remote controller
8. Ground wire

7-2 How to lay the power supply wiring and transmission wiring

Let the power supply wiring and transmission wiring with a conduit pass through one of the knockout on the front or side cover, and let the transmission wiring with a conduit pass through another knockout.

- For protection from uninsulated live parts, thread the power supply wiring and the transmission wiring through the included insulation tube and secure it with the included clamp.

<Power supply wiring>

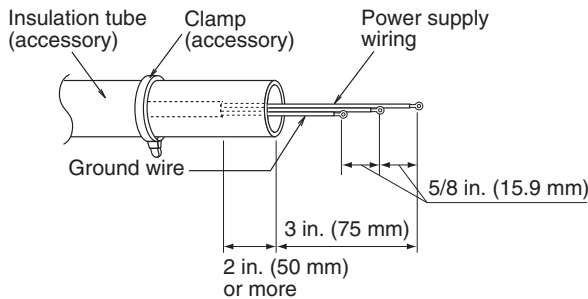

<Transmission wiring>

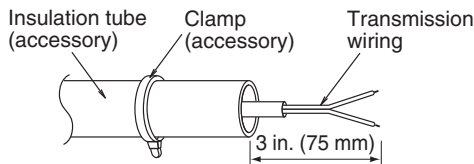

Precautions knockout

- Open the knockout with a hammer or the like.
- After knocking out the knockout, we recommend you remove burrs in the knockout and paint the edges and areas around the edges using the repair paint to prevent rusting.
- When passing wiring through knockout, make sure there are no burrs, and protect the wiring with protective tape.

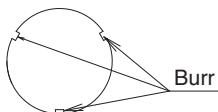

If small animals might enter the unit, block the knockout with an appropriate material (field supply).

(Refer to figure 23)

1. Stop valve fixing plate
2. Power supply wiring (including ground wire) or transmission wiring.
3. Back of unit
4. Knockout
5. Side of unit
6. Front of unit
7. Terminal block
8. Control Box

<Precautions when laying power supply wiring>

- Wiring of different thicknesses cannot be connected to the power supply terminal block. (Slack in the power supply wiring may cause abnormal heat.)
- Use sleeve-insulated round pressure terminals for connections to the power supply terminal block. When none are available, connect wire of the same diameter to both sides, as shown in the figure.

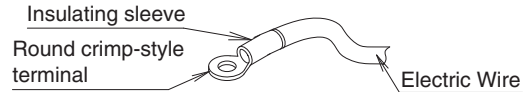

Connect wires of the same gauge to both side.

Do not connect wires of the same gauge to one side.

Do not connect wires of different gauges.

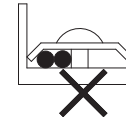
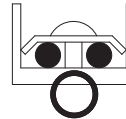

Follow the instructions below if the wiring gets very hot due to slack in the power supply wiring.

- For wiring, use the designated power wire and connect firmly, then secure using the included clamping material to prevent outside pressure being exerted on the terminal board.
- Use an appropriate screwdriver for tightening the terminal screws. A screwdriver with a small head will strip the head and make proper tightening impossible.
- Over-tightening the terminal screw may break it.

See the table below the tightening torque of the terminal screws.

Tightening torque (ft.lbf / N-m)		
M5	Power supply terminal	1.76~2.15 / 2.39~2.91
M4	Shield ground	0.87~1.06 / 1.18~1.44
M3	Transmission wiring terminal block	0.58~0.72 / 0.8~0.97

7-3 How to connect the power supply wiring

CAUTION

Attach a circuit breaker or fuse.

Model	Phase and frequency	Voltage	Maximum overcurrent protective device	Minimum circuit ampacity
18-24 type	1-60Hz	208/230V	20A	16.5A
30-36-42-48 type	1-60Hz	208/230V	35A	29.1A



CAUTION

- The wiring should be selected in compliance with local specifications. See the table above.
- Always turn off the power before doing wiring work.
- Grounding should be done in compliance with local laws and regulations.
- As shown in figure 25, when connecting the power supply wiring to the power supply terminal block, be sure to clamp securely.
- Once wiring work is completed, check to make sure there are no loose connections among the electrical parts in the control box.

(Refer to figure 24)

1. Stop valve fixing plate
2. Clamp (accessory)
3. Connecting power supply wiring
4. Ground wire (Yellow/Green)
5. Terminal block (X1M)
6. Transmission wiring
7. (To X2M [TO IN/ D UNIT] (F1, F2))
8. Terminal block (X2M)
9. Insulation tube (Large) (accessory)
10. Insulation tube (Small) (accessory)
11. Cut off the insulation tube sticking out of the outdoor unit.
12. Wire clamp and screw (accessory)

7-4 Transmission wiring connection procedure

- If an excessive force is applied while connecting a wire to the terminal block, the connection may be damaged.

(Refer to figure 25)

1. Terminal block (X2M)
2. Use balance type shield wire (with no polarity).
3. Indoor unit
4. Under no circumstances should 208/230V be connected.

Precautions regarding the length of wiring between units

Exceeding the following limits may cause transmission malfunctions, so observe them.

Max. wiring length Max. 3280 ft. (1000 m)

Precautions regarding wiring between units

- **Do not connect 208/230V power supply wiring to terminals for the transmission wiring. Doing so would destroy the entire system.**
- Wiring to the indoor unit should be wired to F1 and F2 (TO IN/D unit) on the outdoor unit's terminal block (X2M).

NOTE

- The above wiring should be wired using AWG18-16 (0.75-1.25 mm²) stranded, non-shielded wiring. (See figure 25 for how to ground the shielded parts.)
- All transmission wiring is to be procured on site.

8. ADDITIONAL REFRIGERANT CHARGE



WARNING

- When leaving the unit with the power on, be sure to switch with another person doing the installation or close the front panel.



8-1 Before adding refrigerant

- Make sure the following work and inspection is complete, in accordance with the installation manual.
 - Piping
 - Wiring
 - Air tight test, Vacuum drying

8-2 Checking the refrigerant tank

- Charge the refrigerant to the liquid pipe in its liquid state. Since R410A is a mixed refrigerant, its composition changes if charged in a gaseous state and normal system operation would no longer be assured.
- Check whether the tank has a siphon pipe before charging and place the tank so that the refrigerant is charged in liquid form. (See the figure below.)

Tank with siphon pipe



There is a siphon pipe inside, so the cylinder need not be upside-down to fill with liquid. (Stand the cylinder upright when filling.)

Other tanks



Stand the tank upside down and charge.

8-3 Adding refrigerant



WARNING

- To avoid injury always use protective gloves and eye protection when charging refrigerant.
- To avoid injury do not charge with unsuitable substances. Use only the appropriate refrigerant.



NOTE

- Refrigerant cannot be charged until field wiring has been completed. Refrigerant may only be charged after performing the airtight test and the vacuum drying (see above). When charging refrigerant into the system, take care that its maximum allowable charge is never exceeded, in view of the danger of liquid hammer. Refrigerant containers shall be opened slowly. To avoid compressor breakdown, do not charge the refrigerant more than the specified amount to raise the condensing pressure.

Filling after calculating the amount of refrigerant to add

1. Calculate the amount of refrigerant to add as described below.

<Calculation for refrigerant charging amount>

Refrigerant equivalent to 15 ft. (4.5 m) liquid piping is factory-charged in the outdoor unit.

Calculate the refrigerant charging amount based on the following formula.

- If the liquid piping length is 15 ft. (4.5 m) or less (lbs)

		Additional refrigerant charging amount [A]
Indoor unit type	FAQ, FBQ, FCQ, FHQ	0
	FTQ18-24	0.10
	FTQ30-36	0.71
	FTQ42-48	1.05

- If the liquid piping length is more than 15 ft. (4.5 m)

[A]	+	(Liquid piping length-15) ft. × 0.036	=	Additional refrigerant charging amount
lbs		lbs		lbs

Record the additional amount to the label stuck on the back of front panel.

2. After the vacuum drying is finished, open valve A and charge the calculated amount of refrigerant through the service port for the liquid-side stop valve. (See "Stop valve operation procedure" in "6. REFRIGERANT PIPING" for details on how to use the stop valve.)

(Refer to figure 26)

1. R410A Tank (Siphon system)
2. Measuring instrument
3. Valve A
4. Indoor unit
5. Stop valve service port
6. Gas line stop valve
7. Outdoor unit
8. Liquid line stop valve

State of valve A and the stop valve	Valve A	Liquid line stop valve	Gas line stop valve
Before starting to charge the refrigerant	Close	Close	Close
During charging of the refrigerant	Open	Close	Close

3. Close valve A after charging is complete.

Note: If all the refrigerant to be added cannot be charged using the above procedure, re-charge the refrigerant as below.

If all the refrigerant could not be added

Add refrigerant referring to the “Service Precautions” plate attached to the outdoor unit for details on the settings for adding refrigerant.

9. POST-WORK CHECKS

Perform the following checks after work is complete.

- (1) Drain pipe connection, removal of transport bracket → See “5. PRECAUTIONS ON INSTALLATION”.
- (2) Incorrect power supply wiring, loose screws → See “7-3 How to connect the power supply wiring”.
- (3) Incorrect transmission wiring, loose screws → See “7-4 Transmission wiring connection procedure”.
- (4) Incorrect refrigerant piping connections → See “6. REFRIGERANT PIPING”.
- (5) Piping sizes, use of insulation → See: “6-2 Selecting piping material”. “6-6 Thermal insulation of piping”.
- (6) Stop valve check → Make sure both the liquid-side and gas-side stop valves are open.
- (7) Record of Amount of Refrigerant Added → Record it on “Record of Amount of Refrigerant Added” on the “Service Precautions” label.
- (8) Measuring the insulation of the main power circuit →
 - Use a 500V mega-tester.
 - Do not use the mega-tester for low voltage other than 208/230V. (Transmission wiring)

CAUTION

To the piping installer

After completing installation, be sure to open the valves. (Operating the unit with the valve shut will break the compressor.)

10. TEST OPERATION

This unit is equipped with a crank case heater to ensure smooth startup. Be sure to turn the power on at least 6 hours before operation in order to have power running to the crank case heater.

WARNING

When leaving the unit with the power on, be sure to switch with another person doing the installation or close the front panel.



Precautions before turning the power on

- Using insulating sheets, tape electric parts as described in the “Service Precautions” label on the back of the front panel.
- The indoor unit connected to the outdoor unit operates automatically. Complete work on the indoor unit in order to ensure maximum safety.

10-1 Power On–Check Operation

- Make sure to perform the check operation after installation. (If the air conditioner is operated using the indoor remote controller without performing the check operation, the malfunction code “U3” is displayed in the indoor remote controller, and normal operation is disabled.)
- When making settings on the outdoor unit PC board (A1P or A2P) after turning the power on, do not touch anything other than the push-button switches and dip switches. (See the “Service Precautions” label for the locations of the push-button switches (BS1-5) and dip switches (DS1-1, 2) on the PC board (A1P or A2P).)
- During the operation, monitor the outdoor unit operation status and check for any incorrect wiring.

1. Close the outdoor unit's front panel. Turn the power on for the outdoor unit and the indoor unit.	Caution Be sure to turn the power on at least 6 hours before operation in order to have power running to the crank case heater.																								
2. • Open the outdoor unit's front panel. • Make sure the LED display on the outdoor unit's PC board (A1P or A2P) is as shown in the following table.																									
<18-24 type>	<table border="1"> <thead> <tr> <th>A1P</th> <th colspan="7">A2P</th> </tr> <tr> <th>HAP</th> <th>H1P</th> <th>H2P</th> <th>H3P</th> <th>H4P</th> <th>H5P</th> <th>H6P</th> <th>H7P</th> </tr> </thead> <tbody> <tr> <td>LED display (Default status before delivery)</td> <td>☀</td> <td>●</td> <td>●</td> <td>☀</td> <td>●</td> <td>●</td> <td>●</td> </tr> </tbody> </table>	A1P	A2P							HAP	H1P	H2P	H3P	H4P	H5P	H6P	H7P	LED display (Default status before delivery)	☀	●	●	☀	●	●	●
A1P	A2P																								
HAP	H1P	H2P	H3P	H4P	H5P	H6P	H7P																		
LED display (Default status before delivery)	☀	●	●	☀	●	●	●																		
<30-48 type>	<table border="1"> <thead> <tr> <th colspan="8">A1P</th> </tr> <tr> <th>HAP</th> <th>H1P</th> <th>H2P</th> <th>H3P</th> <th>H4P</th> <th>H5P</th> <th>H6P</th> <th>H7P</th> </tr> </thead> <tbody> <tr> <td>LED display (Default status before delivery)</td> <td>☀</td> <td>●</td> <td>●</td> <td>☀</td> <td>●</td> <td>●</td> <td>●</td> </tr> </tbody> </table>	A1P								HAP	H1P	H2P	H3P	H4P	H5P	H6P	H7P	LED display (Default status before delivery)	☀	●	●	☀	●	●	●
A1P																									
HAP	H1P	H2P	H3P	H4P	H5P	H6P	H7P																		
LED display (Default status before delivery)	☀	●	●	☀	●	●	●																		
LED display: ● OFF ☀ ON ☀ Blinking																									
! To avoid the risk of electric shock, do not touch anything other than the push-button switches on the PC board (A1P or A2P) when making settings.																									
3. • When the customer requests quiet operation or demand operation, make these settings using the push-button switches (BS1-5) on the outdoor unit's PC board (A1P or A2P). • Operate the push-button switches through the opening after protecting it with an insulation cover. (See the “Service Precautions” label for details.)	! Use caution to avoid electric shock while working, since the outdoor unit is on. • Only set the push-button switches (BS1-5) after making sure the operation pilot lamp on PC board is lit up. • See the “Service Precautions” label on the back side of the front panel for details on how to make the settings. (Do not forget to write the settings down on the “Service Precautions” label.) • The dip switch (DS1-1) does not need to be set, so do not touch it. Doing so may cause malfunction.																								
4. • Check that the liquid and gas-side stop valves are open, and if they are closed, open them.	Caution Do not leave any stop valve closed otherwise the compressor will fail.																								
5. Press the test operation button (BS4) for at least five seconds and perform check operation. For details, see “How to perform check operation” on the “Service Precautions” label.	• If you have to leave the outdoor unit during check operation, either switch with another worker or close the front panel. • The system operates for about 30 minutes (60 minutes at maximum) and automatically stops the check operation. • The system can start normal operation about 3 minutes after the check operation if the remote controller does not display any malfunction code. The remote controller will show the test operation display during check operation.																								
6. Close the front panel of the outdoor unit after check operation is complete.																									

<Precautions During Check Operation>

- If operation is performed within 12 minutes of the indoor and outdoor units being turned on, H2P will light up, and the compressor will not run. Only perform operation after checking that the LED display is as shown in “10-1 Power On–Check Operation” 2. table.
- In order to ensure uniform refrigerant distribution, it may take up to around 10 minutes for the compressor to start up after the unit begins running. This is not a malfunction.
- The check operation cannot be performed in other modes.
- If the discharge pipe thermistor (R2T), the suction pipe thermistor (R3T), and the pressure sensors (S1NPH and S1NPL) are removed before operation, the compressor might burn out, so avoid this under all circumstances.

10-2 Temperature control operation checklist

- After check operation is complete, check the temperature control using normal operation.
(Heating is not possible if the outdoor temperature is 75°F (24°C) or higher.)
- (1) Make sure the indoor and outdoor units are operating normally.
(If liquid compression by the compressor or other abnormal noises can be heard, stop the unit immediately, heat the crank case for a sufficient amount of time, and try again.)
- (2) Check to see if cold (or hot) air is coming out of the indoor unit.
- (3) Press the fan direction and fan speed buttons on the indoor unit to see if they operate properly.

<Precautions during temperature control checks>

- For around 5 minutes after the compressor stops, the compressor will not run even if the “On/Off” button on the remote controller is pressed.
- When the system operation is stopped by the remote controller, the outdoor unit may continue operating for up to 1 minute.
- Malfunction code “U3” is displayed if check operation is not performed using the test operation button the first time after installation. Perform the check operation in accordance with “10-1 Power On–Check Operation”.

[Remote controller displays malfunction code] (Check on a remote controller)

Malfunction code	Installation error	Remedial action
E3	The stop valve of outdoor unit is left closed.	Open the gas-side stop valve and the liquid-side stop valve.
	Refrigerant overcharge.	Recalculate the required amount of refrigerant from the piping length and correct the refrigerant charge level by recovering any excessive refrigerant with a refrigerant recovery unit.
F6	Refrigerant overcharge.	Recalculate the required amount of refrigerant from the piping length and correct the refrigerant charge level by recovering any excessive refrigerant with a refrigerant recovery unit.
E4	The stop valve of outdoor unit is left closed.	Open the gas-side stop valve and the liquid-side stop valve.
	Insufficient refrigerant.	Check if the additional refrigerant charge has been finished correctly. Recalculate the required amount of refrigerant from the piping length and add an adequate amount of refrigerant.
F3	Refrigerant overcharge.	Recalculate the required amount of refrigerant from the piping length and correct the refrigerant charge level by recovering any excessive refrigerant with a refrigerant recovery unit.
	The stop valve of outdoor unit is left closed.	Open the gas-side stop valve and the liquid-side stop valve.
U2	Insufficient power supply voltage	Check to see if the power supply voltage is supplied properly.
	If check operation has not been performed.	Perform check operation.
U4	No power is supplied to outdoor unit.	Turn the power on for the outdoor unit.
UA	If no dedicated indoor unit is being used.	Check the indoor unit. If it is not a dedicated unit, replace the indoor unit.

UF	The stop valve of outdoor unit is left closed.	Open the gas-side stop valve and the liquid-side stop valve.
	If the right indoor unit piping and wiring are not properly connected to the outdoor unit.	Make sure that the right indoor unit piping and wiring are properly connected to the outdoor unit.
UH	If the transmission wiring has not be connected or it has shorted.	Make sure the transmission wiring is correctly attached to terminals (X2M) F1/F2 (TO IN/D UNIT) on the outdoor unit circuit board.

- When using a central controller, see the installation manual or service manual which came with the central controller.

[If nothing is displayed on the remote controller]

- There might be a problem with the connections or communication between the indoor unit and the remote controller. Make sure all the wiring is properly connected.



CAUTION

To the piping installer, To the electrician

After the test operation, when handing the unit over to the customer, make sure the front panel on the unit and all screws are attached.

10-3 Final refrigerant charge adjustment

It is not necessary to do this final adjustment normally, but perform the following operation only when the most adequate refrigerant charge for the best performance is required and the piping length between the outdoor and indoor units is less than 50 ft. (15 m).
The outdoor temperature must be between 65°F (18°C) and 105°F (40°C).

The number of revolutions of the compressor must be greater than or equal to the charge mode. (It can be confirmed by LED display on PC board)

The number of revolutions of the compressor LED display.
(○●●●●●●○:Chargeable ○●●●●●●●:Impossible to charge)

Run the system for 60 minutes in cooling by the forced operation using the field setting mode 2, No.20 LED ○●●:ON, mode 2, No.7 LED ○●●:ON, (Refer to Service Manual.) to allow pressures to stabilize.

Check subcooling of outdoor unit at LSV. Systems should have the target subcooling in the table below.

- If the subcooling is low, add charge little by little to raise subcooling to the target value. (The maximum additional charge is 2.2 lbs. (1kg))
- If the subcooling is high, remove charge to lower the subcooling to the target value.

Model	Target subcooling
18-24 type	6±1°F (3.33±0.56°C)
30-36 type	7±1°F (3.89±0.56°C)
42 type	8±1°F (4.44±0.56°C)
48 type	9±1°F (5.00±0.56°C)

11. ENERGY SAVING AND OPTIMUM OPERATION

The unit is equipped with advanced energy saving functionality. Depending on the priority, emphasis can be put on energy saving or comfort level. Several parameters can be selected, resulting in the optimal balance between energy consumption and comfort for the particular application.

Several patterns are available and explained below. Modify the parameters to the needs of your building and to realize the best balance between energy consumption and comfort.

Refer to Service Manual for changing the field settings.

Setting definition: [A-B]=C; A=mode, B=setting NO., C=setting value.

11-1 Three main operation methods are available:

• Basic

The refrigerant temperature is fixed independent from the situation. It corresponds to the standard operation which is known and can be expected from/under previous systems:

- To activate this operation method under cooling operation: change field setting [2-8]=2.
- To activate this operation method under heating operation: change field setting [2-9]=2.

• Automatic (default)

The refrigerant temperature is set depending on the outdoor ambient conditions. As such adjusting the refrigerant temperature to match the required load (which is also related to the outdoor ambient conditions). E.g., when your system is operating in cooling, you do not need as much cooling under low outdoor ambient temperatures (e.g., 77°F (25°C)) as under high outdoor ambient temperatures (e.g., 95°F (35°C)).

Using this idea, the system automatically starts increasing its refrigerant temperature, automatically reducing the delivered capacity and increasing the system's efficiency.

- To activate this operation method under cooling operation: change field setting [2-8]=3 (default).

E.g., when your system is operating in heating, you do not need as much heating under high outdoor ambient temperatures (e.g., 59°F (15°C)) as under low outdoor ambient temperatures (e.g., 23°F (-5°C)).

Using this idea, the system automatically starts decreasing its refrigerant temperature, automatically reducing the delivered capacity and increasing the system's efficiency.

- To activate this operation method under heating operation: change field setting [2-9]=1 (default).

• Hi-sensible (cooling)

The refrigerant temperature is set higher (cooling) compared to basic operation. The focus under high sensible mode is improved comfort for the customer.

The selection method of indoor units is important and has to be considered as the available capacity is not the same as under basic operation. For details concerning to Hi-sensible applications, please contact your dealer.

- To activate this setting under cooling operation: change field setting [2-8] to the appropriate value, matching the requirements of the pre-designed system containing a high sensible solution.

Value	To target
4	46°F (8°C)
5	48°F (9°C)
6	50°F (10°C)
7	52°F (11°C)

11-2 Several comfort settings are available

For each of above modes a comfort level can be selected. The comfort level is related to the timing and the effort (energy consumption) which is put in achieving a certain room temperature by temporarily changing the refrigerant temperature to different values in order to achieve requested conditions more quickly.

• Powerful

Overshoot (during heating operation) or undershoot (during cooling operation) is allowed compared to the requested refrigerant temperature, in order to achieve the required room temperature very fast. The overshoot is allowed from the start up moment.

In case of cooling operation the evaporating temperature is allowed to go down to 37°F (3°C) on temporary base depending on the situation.

In case of heating operation the condense temperature is allowed to go up to 120°F (49°C) on temporary base depending on the situation. When the request from the indoor units becomes more moderate, the system will eventually go to the steady state condition which is defined by the operation method above.

- To activate the powerful comfort setting under cooling operation, change field setting [2-41]=3.

This setting is used in conjunction with setting [2-8].

- To activate the powerful comfort setting under heating operation, change field setting [2-42]=3.

This setting is used in conjunction with setting [2-9].

• Quick

Overshoot (during heating operation) or undershoot (during cooling operation) is allowed compared to the requested refrigerant temperature, in order to achieve the required room temperature very fast. The overshoot is allowed from the start up moment.

In case of cooling operation the evaporating temperature is allowed to go down to 43°F (6°C) on temporary base depending on the situation. In case of heating operation the condense temperature is allowed to go up to 115°F (46°C) on temporary base depending on the situation. When the request from the indoor units becomes more moderate, the system will eventually go to the steady state condition which is defined by the operation method above.

- To activate the quick comfort setting under cooling operation, change field setting [2-41]=2.

This setting is used in conjunction with setting [2-8].

- To activate the quick comfort setting under heating operation, change field setting [2-42]=2.

This setting is used in conjunction with setting [2-9].

• Mild

Overshoot (during heating operation) or undershoot (during cooling operation) is allowed compared to the requested refrigerant temperature, in order to achieve the required room temperature very fast. The overshoot is not allowed from the start up moment. The start up occurs under the condition which is defined by the operation mode above.

In case of cooling operation the evaporating temperature is allowed to go down to 43°F (6°C) on temporary base depending on the situation. In case of heating operation the condense temperature is allowed to go up to 115°F (46°C) on temporary base depending on the situation. When the request from the indoor units becomes more moderate, the system will eventually go to the steady state condition which is defined by the operation method above.

The start up condition is different from the powerful and quick comfort setting.

- To activate the mild comfort setting under cooling operation, change field setting [2-41]=1.

This setting is used in conjunction with setting [2-8].

- To activate the mild comfort setting under heating operation, change field setting [2-42]=1.

This setting is used in conjunction with setting [2-9].

• Eco

The original refrigerant temperature target, which is defined by the operation method (see above) is kept without any correction, unless for protection control.

- To activate the mild comfort setting under cooling operation, change field setting [2-41]=0.

This setting is used in conjunction with setting [2-8].

- To activate the mild comfort setting under heating operation, change field setting [2-42]=0.

This setting is used in conjunction with setting [2-9].

No matter which control is selected, variations on the behavior of the system are still possible due to protection controls to keep the unit operating under reliable conditions. The intentional target, however, is fixed and will be used to obtain the best balance between energy consumption and comfort, depending on the application type.

Example: Automatic mode during cooling

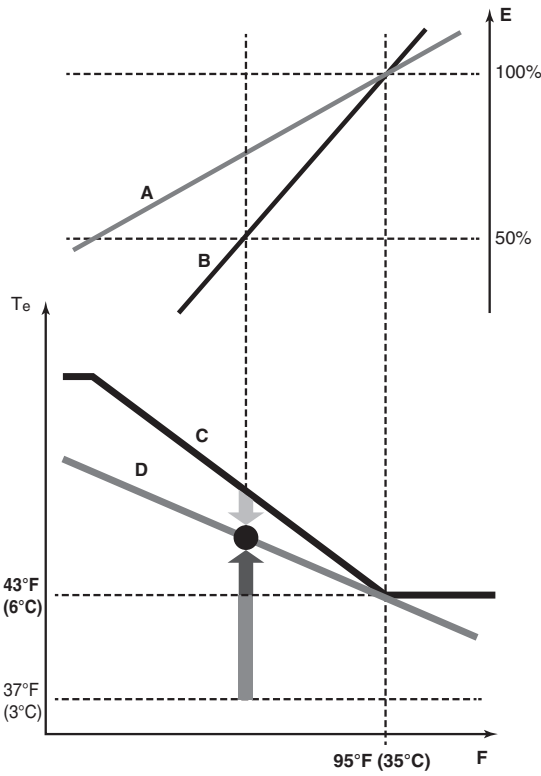

- A** Actual load curve
- B** Virtual load curve (initial capacity automatic mode)
- C** Virtual target value (initial evaporation temperature value automatic mode)
- D** Required evaporation temperature value
- E** Load factor
- F** Outside air temperature
- Te** Evaporating temperature
- Quick
- Powerful
- Mild

Example: Automatic mode during heating

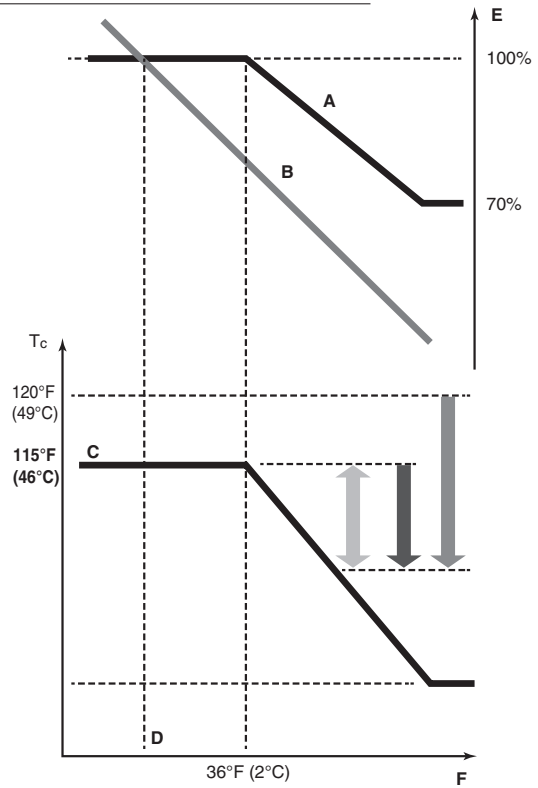

- A** Virtual load curve (default automatic mode peak capacity)
- B** Load curve
- C** Virtual target value (initial condensation temperature value automatic mode)
- D** Design temperature
- E** Load factor
- F** Outside air temperature
- Tc** Condensing temperature
- Quick
- Powerful
- Mild

Room temperature evolution:

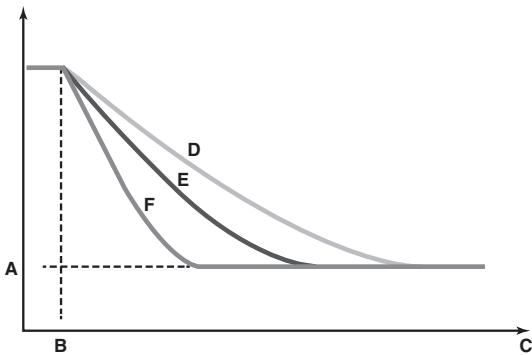

- A** Indoor unit set temperature
- B** Operation start
- C** Operating time
- D** Mild
- E** Quick
- F** Powerful

Room temperature evolution:

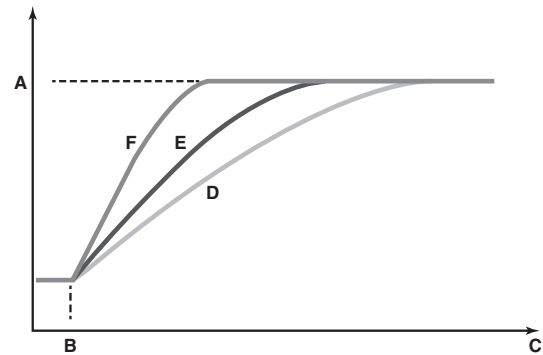

- A** Indoor unit set temperature
- B** Operation start
- C** Operating time
- D** Mild
- E** Quick
- F** Powerful

11-3 Setting of Heat Pump Lockout and Emergency Heat Mode

Heat pump is locked out when the setting below and/or external input to ABC terminal has been made.

No.	Setting item display								Setting condition display								
	Setting item	MODE H1P	TEST H2P	C/H selection			Low noise H6P	Demand H7P	*Factory setting								
				IND H3P	Master H4P	Slave H5P											
16	Setting of heat pump lockout 1	○	●	○	●	●	●	●	OFF	○	●	●	●	●	●	○	*
									ON	○	●	●	●	●	○	●	
37	Setting of heat pump lockout 2	○	○	●	●	○	●	○	OFF	○	●	●	●	●	●	●	*
									Mode 1	○	●	●	●	●	○	●	
									Mode 2	○	●	●	●	●	○	●	
									Mode 3	○	●	●	●	●	○	○	
									Mode 4	○	●	●	●	○	●	●	
									Mode 5	○	●	●	●	○	●	○	
									Mode 6	○	●	●	●	○	○	●	

Type	Description	Actions						
		Field setting	Shorted between	Heating Thermo-on		Heating Thermo-off		
				Heater	Fan	Heater	Fan	
I	–	Heat-pump heating is always locked out	2-16: ON	–	ON	ON (H/L)	OFF	LL
II	Mode 1	Lockout is controlled by ABC terminals	2-37: Mode 1	A-C	ON	ON (H/L)	OFF	LL
	B-C			OFF				
	Mode 2 (for a heater which does not need airflow)		2-37: Mode 2	A-C		LL		LL
	B-C			OFF		OFF		
	Mode 3	Lockout is controlled by the outdoor ambient temperature and setpoint which is configured by the field setting 2-57 and 2-47	2-37: Mode 3	Same as 2-37: Mode 1, A-C shorted				
	Mode 4	2-37: Mode 4	Same as 2-37: Mode 1, B-C shorted					
	Mode 5	2-37: Mode 5	Same as 2-37: Mode 2, A-C shorted					
Mode 6	2-37: Mode 6	Same as 2-37: Mode 2, B-C shorted						

Heat pump lockout temperature

Heat pump would be locked out when the outdoor ambient temperature is smaller than the heat pump lockout temperature.

This setting is only effective when heat pump lockout mode has been set.

And should make the field setting of indoor unit. Refer to Service Manual for details.

No.	Setting item display								Setting condition display									
	Setting item	MODE H1P	TEST H2P	C/H selection			Low noise H6P	Demand H7P										
				IND H3P	Master H4P	Slave H5P												
57	Heat pump lockout temperature	<input type="radio"/>	<input type="radio"/>	<input type="radio"/>	<input type="radio"/>	<input checked="" type="radio"/>	<input checked="" type="radio"/>	<input type="radio"/>	-26.1°C (-15°F)	<input type="radio"/>	<input checked="" type="radio"/>	<input checked="" type="radio"/>	<input checked="" type="radio"/>	<input checked="" type="radio"/>	<input checked="" type="radio"/>	<input checked="" type="radio"/>	<input checked="" type="radio"/>	*
									-23.3°C (-10°F)	<input type="radio"/>	<input checked="" type="radio"/>	<input checked="" type="radio"/>	<input checked="" type="radio"/>	<input checked="" type="radio"/>	<input checked="" type="radio"/>	<input type="radio"/>		
									-20.5°C (-5°F)	<input type="radio"/>	<input checked="" type="radio"/>	<input checked="" type="radio"/>	<input checked="" type="radio"/>	<input checked="" type="radio"/>	<input type="radio"/>	<input checked="" type="radio"/>		
									-17.7°C (0°F)	<input type="radio"/>	<input checked="" type="radio"/>	<input checked="" type="radio"/>	<input checked="" type="radio"/>	<input checked="" type="radio"/>	<input type="radio"/>	<input type="radio"/>		
									-15°C (5°F)	<input type="radio"/>	<input checked="" type="radio"/>	<input checked="" type="radio"/>	<input checked="" type="radio"/>	<input type="radio"/>	<input checked="" type="radio"/>	<input checked="" type="radio"/>		
									-12.2°C (10°F)	<input type="radio"/>	<input checked="" type="radio"/>	<input checked="" type="radio"/>	<input checked="" type="radio"/>	<input type="radio"/>	<input checked="" type="radio"/>	<input type="radio"/>		
									-9.4°C (15°F)	<input type="radio"/>	<input checked="" type="radio"/>	<input checked="" type="radio"/>	<input checked="" type="radio"/>	<input type="radio"/>	<input type="radio"/>	<input checked="" type="radio"/>		
									-6.6°C (20°F)	<input type="radio"/>	<input checked="" type="radio"/>	<input checked="" type="radio"/>	<input checked="" type="radio"/>	<input type="radio"/>	<input type="radio"/>	<input type="radio"/>		
									-3.8°C (25°F)	<input type="radio"/>	<input checked="" type="radio"/>	<input checked="" type="radio"/>	<input type="radio"/>	<input checked="" type="radio"/>	<input checked="" type="radio"/>	<input checked="" type="radio"/>		
									-1.1°C (30°F)	<input type="radio"/>	<input checked="" type="radio"/>	<input checked="" type="radio"/>	<input type="radio"/>	<input checked="" type="radio"/>	<input checked="" type="radio"/>	<input type="radio"/>		
									1.6°C (35°F)	<input type="radio"/>	<input checked="" type="radio"/>	<input checked="" type="radio"/>	<input type="radio"/>	<input checked="" type="radio"/>	<input type="radio"/>	<input checked="" type="radio"/>		
									4.4°C (40°F)	<input type="radio"/>	<input checked="" type="radio"/>	<input checked="" type="radio"/>	<input type="radio"/>	<input checked="" type="radio"/>	<input type="radio"/>	<input type="radio"/>		
									7.2°C (45°F)	<input type="radio"/>	<input checked="" type="radio"/>	<input checked="" type="radio"/>	<input type="radio"/>	<input type="radio"/>	<input checked="" type="radio"/>	<input checked="" type="radio"/>		
									10°C (50°F)	<input type="radio"/>	<input checked="" type="radio"/>	<input checked="" type="radio"/>	<input type="radio"/>	<input type="radio"/>	<input checked="" type="radio"/>	<input type="radio"/>		
									Forced heat pump lockout	<input type="radio"/>	<input checked="" type="radio"/>	<input checked="" type="radio"/>	<input type="radio"/>	<input type="radio"/>	<input type="radio"/>	<input checked="" type="radio"/>		

Heat pump lockout release differential

Heat pump would be resumed when the outdoor ambient temperature is recovered by differential above the heat pump lockout temperature.

No.	Setting item display								Setting condition display									
	Setting item	MODE H1P	TEST H2P	C/H selection			Low noise H6P	Demand H7P										
				IND H3P	Master H4P	Slave H5P												
47	Heat pump lockout release differential	<input type="radio"/>	<input type="radio"/>	<input checked="" type="radio"/>	<input type="radio"/>	<input type="radio"/>	<input type="radio"/>	<input type="radio"/>	2.8°C (5°F)	<input type="radio"/>	<input checked="" type="radio"/>	<input checked="" type="radio"/>	<input checked="" type="radio"/>	<input checked="" type="radio"/>	<input checked="" type="radio"/>	<input checked="" type="radio"/>		
									5.6°C (10°F)	<input type="radio"/>	<input checked="" type="radio"/>	<input checked="" type="radio"/>	<input checked="" type="radio"/>	<input checked="" type="radio"/>	<input checked="" type="radio"/>	<input type="radio"/>	*	
									8.3°C (15°F)	<input type="radio"/>	<input checked="" type="radio"/>	<input checked="" type="radio"/>	<input checked="" type="radio"/>	<input checked="" type="radio"/>	<input type="radio"/>	<input checked="" type="radio"/>		

Automatic lockout

When heat pump lockout mode has been set, the auto backup function will automatically be set. This will allow the auxiliary or secondary heat source to be automatically energized in the event of a system failure related to outdoor units.

12. CAUTION FOR REFRIGERANT LEAKS

(Points to note in connection with refrigerant leaks)

Introduction

The installer and system specialist shall secure safety against leakage according to local regulations or standards. The following standards may be applicable if local regulations are not available.

The SPLIT System, like other air conditioning systems, uses R410A as refrigerant. R410A itself is an entirely safe non-toxic, non-combustible refrigerant. Nevertheless care must be taken to ensure that air conditioning facilities are installed in a room which is sufficiently large. This assures that the maximum concentration level of refrigerant gas is not exceeded, in the unlikely event of major leak in the system and this in accordance to the local applicable regulations and standards.

Maximum concentration level

The maximum charge of refrigerant and the calculation of the maximum concentration of refrigerant is directly related to the humanly occupied space in to which it could leak.

The unit of measurement of the concentration is lb./ft³ (the weight in lb. of the refrigerant gas in 1ft³ volume of the occupied space).

Compliance to the local applicable regulations and standards for the maximum allowable concentration level is required.

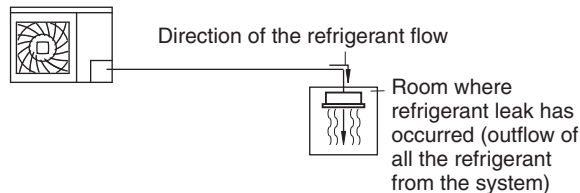

Pay a special attention to the place, such as a basement, etc. where refrigerant can stay, since refrigerant is heavier than air.

Procedure for checking maximum concentration

Check the maximum concentration level in accordance with steps 1 to 4 below and take whatever action is necessary to comply.

1. Calculate the amount of refrigerant (lb.) charged to each system separately.

amount of refrigerant in the unit (amount of refrigerant with which the system is charged before leaving the factory)	+	additional charging amount (amount of refrigerant added locally in accordance with the length of the refrigerant piping and type of indoor unit)	=	total amount of refrigerant (lb.) in the system
--	---	--	---	---

NOTE

- Where a single refrigerant facility is divided into 2 entirely independent refrigerant systems then use the amount of refrigerant with which each separate system is charged.

2. Calculate a room volume (ft³)

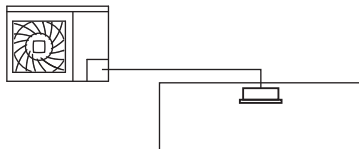

3. Calculating the refrigerant concentration by using the results of the calculations in steps 1 and 2 above.

$\frac{\text{total amount of refrigerant in the refrigerant system}}{\text{volume (ft}^3\text{) of the room in which there is an indoor unit installed}}$	\leq	maximum concentration level (lb./ft ³)
---	--------	--

4. Dealing with the situations where the result exceeds the maximum concentration level.

Where the installation of a facility results in a concentration in excess of the maximum concentration level then it will be necessary to revise the system.

Please consult your dealer.

DAIKIN MANUFACTURING COMPANY, L.P

Daikin Texas Technology Park,
19001 Kermier Road,
Waller, TX, 77484, U.S.A.



Intertek