



SERVICE MANUAL

Inverter Wall Mounted Single Split

MODELS

Cooling Only

FTKB09AXVJU

FTKB12AXVJU

FTKB18AXVJU

FTKB24AXVJU

RKB09AXVJU

RKB12AXVJU

RKB18AXVJU

RKB24AXVJU

FTKN09AXVJU

FTKN12AXVJU

FTKN18AXVJU

FTKN24AXVJU

RKN09AXVJU

RKN12AXVJU

RKN18AXVJU

RKN24AXVJU

Heatpump

FTXB09AXVJU

FTXB12AXVJU

FTXB18AXVJU

FTXB24AXVJU

RXB09AXVJU

RXB12AXVJU

RXB18AXVJU

RXB24AXVJU

FTXN09AXVJU

FTXN12AXVJU

FTXN18AXVJU

FTXN24AXVJU

RXN09AXVJU

RXN12AXVJU

RXN18AXVJU

RXN24AXVJU





Table of Contents

1.0 Inverter Single Split	1
1.1 Product line-up	1
1.2 Printed Circuit board (PCB) connector wiring diagram.....	3
1.3 Piping Length & Elevation	10
1.4 Outline & Dimension.....	11
1.5 Engineering Data.....	15
2.0 Function & Control	17
2.1 Temperature Control.....	17
2.2 Cooling and Heating Mode Operation	17
2.3 Dry Mode	18
2.4 Fan Mode	19
2.5 Auto Mode	19
2.6 Cold Draft Prevention	19
2.7 Sleep Mode	20
2.8 Quiet Function.....	20
2.9 Eco+ Function.....	20
2.10 Powerful Function.....	21
2.11 Indoor - Outdoor Communication	21
2.12 Thermistors in RK(X)B,RK(X)N	22
2.13 Minimum Off Time Control.....	23
2.14 Auto Restart.....	23
2.15 Auto Random Restart	23
2.16 Four Way Valve Control.....	24
2.17 Outdoor Fan Control.....	24
2.18 Rotation Regulating Functions	25
2.19 Defrost Cycle	26
2.20 Indoor Coil Freeze Prevention.....	27
2.21 High Pressure Protection.....	27
2.22 Discharge Pipe Temperature Control	28
2.23 Overall Current Control.....	28
2.24 Overall Frequency Control.....	29
3.0 Service Diagnosis	31
3.1 Error Indication from Indoor.....	31
3.2 Error Code retrieved by handset.....	33
3.3 Error code description for Inverter	34







4.0 Wiring Connection.....61
5.0 Refrigerant Diagram65
6.0 Appendix A.....67









Safety Cautions

Caution and warnings











- Be sure to read the following safety cautions before conducting repair work.
- The caution items are classified into “ **Warning**” and “ **Caution**”. The “ **Warning**” items are especially important since they can lead to death or serious injury if they are not followed closely. The “ **Caution**” items can also lead to serious accidents under some conditions if they are not followed. Therefore, be sure to observe all the safety caution items described below.
- About the pictograms
 - △ This symbol indicates an item for which caution must be exercised.
The pictogram shows the item to which attention must be paid.
 - This symbol indicates a prohibited action.
The prohibited item or action is shown inside or near the symbol.
 - This symbol indicates an action that must be taken, or an instruction.
The instruction is shown inside or near the symbol.
- After the repair work is complete, be sure to conduct a test operation to ensure that the equipment operates normally, and explain the cautions for operating the product to the customer.





Caution in Repair

 Warning	
<p>Be sure to disconnect the power cable plug from the plug socket before disassembling the equipment for a repair. Working on the equipment that is connected to a power supply can cause an electrical shock. If it is necessary to supply power to the equipment to conduct the repair or inspecting the circuits, do not touch any electrically charged sections of the equipment.</p>	
<p>If the refrigerant gas discharges during the repair work, do not touch the discharging refrigerant gas. The refrigerant gas can cause frostbite.</p>	
<p>When disconnecting the suction or discharge pipe of the compressor at the welded section, release the refrigerant gas completely at a well-ventilated place first. If there is a gas remaining inside the compressor, the refrigerant gas or refrigerating machine oil discharges when the pipe is disconnected, and it can cause injury.</p>	
<p>If the refrigerant gas leaks during the repair work, ventilate the area. The refrigerant gas can generate toxic gases when it contacts flames.</p>	
<p>The step-up capacitor supplies high-voltage electricity to the electrical components of the outdoor unit. Be sure to discharge the capacitor completely before conducting repair work. A charged capacitor can cause an electrical shock.</p>	
<p>Do not start or stop the air conditioner operation by plugging or unplugging the power cable plug. Plugging or unplugging the power cable plug to operate the equipment can cause an electrical shock or fire.</p>	





 Caution	
Do not repair the electrical components with wet hands. Working on the equipment with wet hands can cause an electrical shock.	
Do not clean the air conditioner by splashing water. Washing the unit with water can cause an electrical shock.	
Be sure to provide the grounding when repairing the equipment in a humid or wet place, to avoid electrical shocks.	
Be sure to turn off the power switch and unplug the power cable when cleaning the equipment. The internal fan rotates at a high speed, and cause injury.	
Do not tilt the unit when removing it. The water inside the unit can spill and wet the furniture and floor.	
Be sure to check that the refrigerating cycle section has cooled down sufficiently before conducting repair work. Working on the unit when the refrigerating cycle section is hot can cause burns.	
Use the welder in a well-ventilated place. Using the welder in an enclosed room can cause oxygen deficiency.	







Cautions Regarding Products after Repair

 Warning	
<p>Be sure to use parts listed in the service parts list of the applicable model and appropriate tools to conduct repair work. Never attempt to modify the equipment. The use of inappropriate parts or tools can cause an electrical shock, excessive heat generation or fire.</p>	
<p>When relocating the equipment, make sure that the new installation site has sufficient strength to withstand the weight of the equipment. If the installation site does not have sufficient strength and if the installation work is not conducted securely, the equipment can fall and cause injury.</p>	
<p>Be sure to install the product correctly by using the provided standard installation frame. Incorrect use of the installation frame and improper installation can cause the equipment to fall, resulting in injury.</p>	For integral units only
<p>Be sure to install the product securely in the installation frame mounted on a window frame. If the unit is not securely mounted, it can fall and cause injury.</p>	For integral units only
<p>Be sure to use an exclusive power circuit for the equipment, and follow the technical standards related to the electrical equipment, the internal wiring regulations and the instruction manual for installation when conducting electrical work. Insufficient power circuit capacity and improper electrical work can cause an electrical shock or fire.</p>	
<p>Be sure to use the specified cable to connect between the indoor and outdoor units. Make the connections securely and route the cable properly so that there is no force pulling the cable at the connection terminals. Improper connections can cause excessive heat generation or fire.</p>	
<p>When connecting the cable between the indoor and outdoor units, make sure that the terminal cover does not lift off or dismount because of the cable. If the cover is not mounted properly, the terminal connection section can cause an electrical shock, excessive heat generation or fire.</p>	
<p>Do not damage or modify the power cable. Damaged or modified power cable can cause an electrical shock or fire. Placing heavy items on the power cable, and heating or pulling the power cable can damage the cable.</p>	
<p>Do not mix air or gas other than the specified refrigerant (R-410A) in the refrigerant system. If air enters the refrigerating system, an excessively high pressure results, causing equipment damage and injury.</p>	
<p>If the refrigerant gas leaks, be sure to locate the leak and repair it before charging the refrigerant. After charging refrigerant, make sure that there is no refrigerant leak. If the leak cannot be located and the repair work must be stopped, be sure to perform pump-down and close the service valve, to prevent the refrigerant gas from leaking into the room. The refrigerant gas itself is harmless, but it can generate toxic gases when it contacts flames, such as fan and other heaters, stoves and ranges.</p>	
<p>When replacing the coin battery in the remote controller, be sure to disposed of the old battery to prevent children from swallowing it. If a child swallows the coin battery, see a doctor immediately.</p>	

 Caution	
Installation of a leakage breaker is necessary in some cases depending on the conditions of the installation site, to prevent electrical shocks.	
Do not install the equipment in a place where there is a possibility of combustible gas leaks. If a combustible gas leaks and remains around the unit, it can cause a fire.	
Be sure to install the packing and seal on the installation frame properly. If the packing and seal are not installed properly, water can enter the room and wet the furniture and floor.	

Inspection after Repair

 Warning	
Check to make sure that the power cable plug is not dirty or loose, then insert the plug into a power outlet all the way. If the plug has dust or loose connection, it can cause an electrical shock or fire.	
If the power cable and lead wires have scratches or deteriorated, be sure to replace them. Damaged cable and wires can cause an electrical shock, excessive heat generation or fire.	
Do not use a joined power cable or extension cable, or share the same power outlet with other electrical appliances, since it can cause an electrical shock, excessive heat generation or fire.	

 Caution	
Check to see if the parts and wires are mounted and connected properly, and if the connections at the soldered or crimped terminals are secure. Improper installation and connections can cause excessive heat generation, fire or an electrical shock.	
If the installation platform or frame has corroded, replace it. Corroded installation platform or frame can cause the unit to fall, resulting in injury.	
Check the grounding, and repair it if the equipment is not properly grounded. Improper grounding can cause an electrical shock.	
Be sure to measure the insulation resistance after the repair, and make sure that the resistance is 1 Mohm or higher. Faulty insulation can cause an electrical shock.	
Be sure to check the drainage of the indoor unit after the repair. Faulty drainage can cause the water to enter the room and wet the furniture and floor.	

1.0 Inverter Single Split

1.1 Product line-up

1.1.1 Indoor Unit

Nomenclature	Classification														
	Remote Controller				PCB						Air Purification		Marking		Others
	BRC52A61	BRC52A62	BRC52B63	BRC52B64	W_2_03C	W_2_03D	W_2_03E	W_2_03E_M	W_2_04A	W_2_04B	Saranet Filter	Titanium Apatite	UL	CE	Auto Restart
FTKB09/12AXVJU				X				X			X	X	X		X
FTKN09/12AXVJU		X						X			X		X		X
FTKB18/24AXVJU				X						X	X	X	X		X
FTKN18/24AXVJU		X								X	X		X		X
FTXB09/12AXVJU			X					X			X	X	X		X
FTXN09/12AXVJU	X							X			X		X		X
FTXB18/24AXVJU			X							X	X	X	X		X
FTXN18/24AXVJU	X									X	X		X		X

1.1.2 Outdoor Unit

Nomenclature	Classification									
	PCB			Refrigerant Control	Fin		Compressor	Marking		Others
	Main PCB (ADGPA34)	Main PCB (Y364)	Filter PCB (YV62)		EXV	Hydrophilic (Blue)		Hydrophilic (Gold)	DC Inverter Swing	
RKB09/12AXVJU	X			X	X		X	X		
RKN09/12AXVJU	X			X	X		X	X		
RKB18/24AXVJU		X	X	X	X		X	X		
RKN18/24AXVJU		X	X	X	X		X	X		
RXB09/12AXVJU	X			X	X		X	X		X
RXN09/12AXVJU	X			X	X		X	X		X
RXB18/24AXVJU		X	X	X	X		X	X		X
RXN18/24AXVJU		X	X	X	X		X	X		X

1.2 Printed Circuit Board (PCB) connector wiring diagram

1.2.1 Indoor PCB: FTKB09/12AXVJU, FTKN09/12AXVJU, FTXB09/12AXVJU, FTXN09/12AXVJU

1.2.1.1 Main PCB: W_2_03D ; W_2_03E ; W_2_03E_M

Item	Indication on PCB	Description
1	A1	Connector for fan motor
2	A2	Connector for swing motor
3	A3	Connector for fan motor feedback
4	A4	Fuse
5	A5	Varistor
6	A6	Connector for wired controller
7	A7	Connector for signal receiver PCB
8	A8	Connector for heat exchanger thermistor

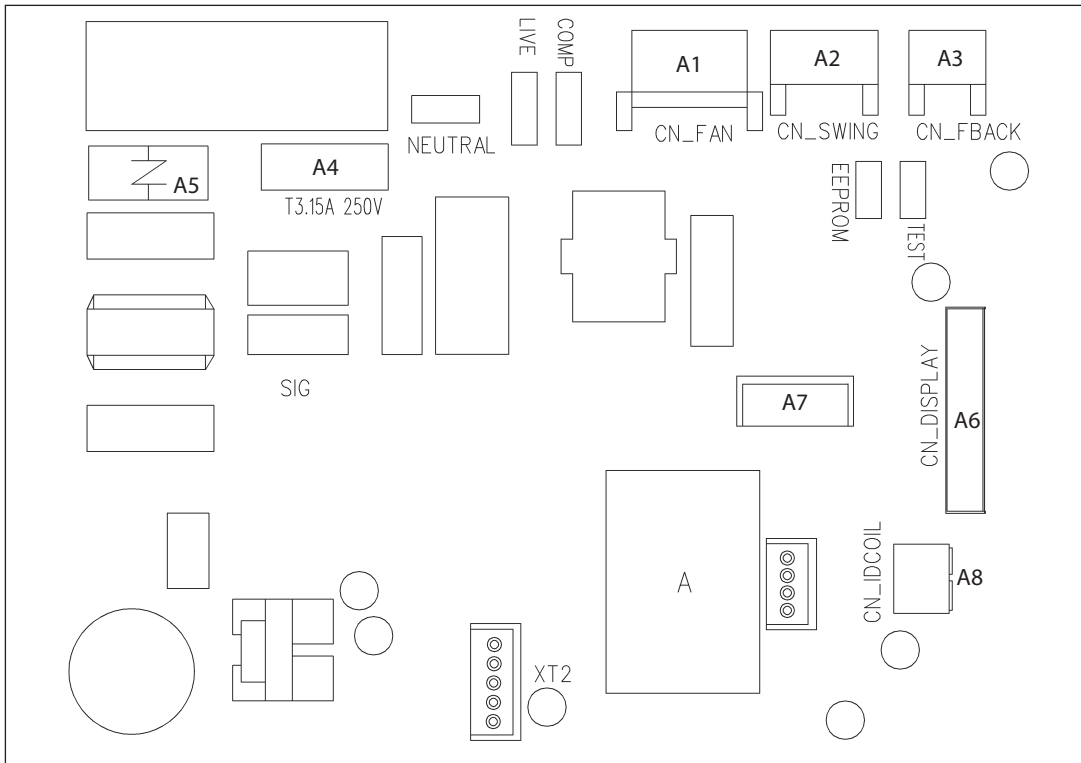

1.2.1.2 Signal board

Item	Indication on PCB	Description
1	A1	Operational LED
2	A2	Connector for Control PCB
3	A3	Remote controller signal receiver
4	A4	Operation ON/OFF switch
5	A5	Buzzer

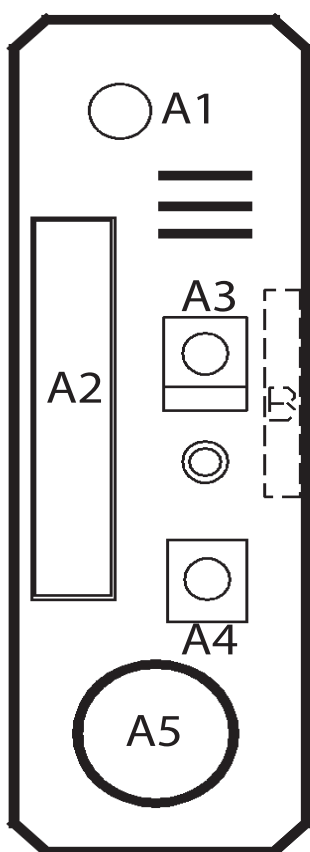

DISPLAY BOARD

Applicable Model :
FTKB09/12AXVJU
FTXB09/12AXVJU

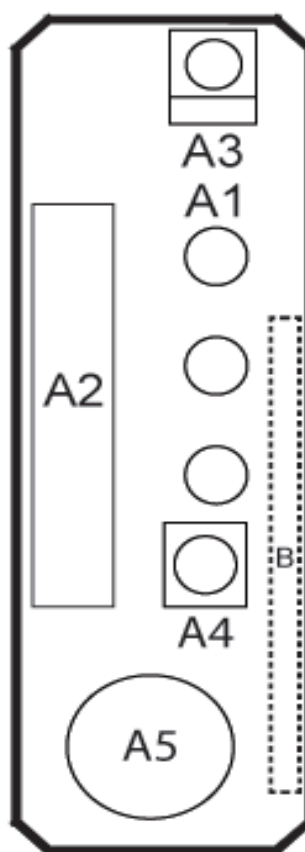

DISPLAY BOARD

Applicable Model :
FTKN09/12AXVJU
FTXN09/12AXVJU

1.2.2 Indoor PCB: FTKB18/24AXVJU, FTKN18/24AXVJU, FTXB18/24AXVJU, FTXN18/24AXVJU

1.2.2.1 Main PCB: W_2_04A ; W_2_04B

Item	Indication on PCB	Description
1	A1	Connector for fan motor
2	A2	Connector for swing motor
3	A3	Connector for fan motor feedback
4	A4	Fuse
5	A5	Varistor
6	A6	Connector for wired controller
7	A7	Connector for signal receiver PCB

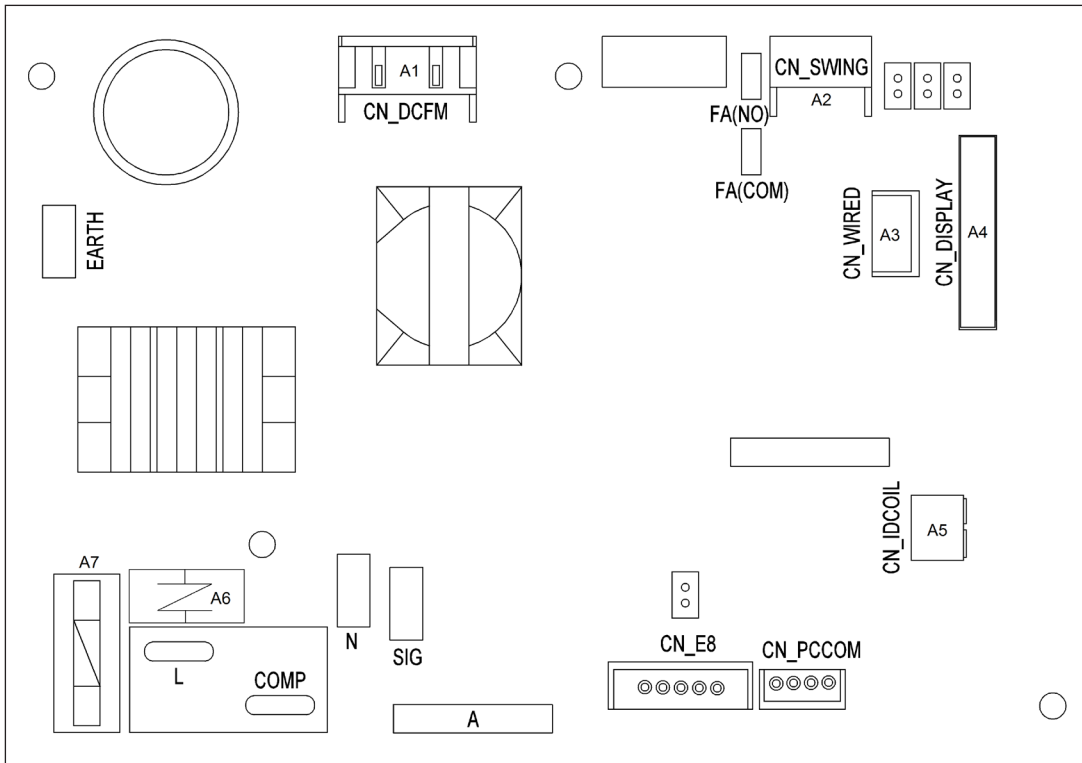

1.2.2.2 Signal board

Item	Indication on PCB	Description
1	A1	Operational LED
2	A2	Connector for Control PCB
3	A3	Remote controller signal receiver
4	A4	Operation ON/OFF switch
5	A5	Buzzer

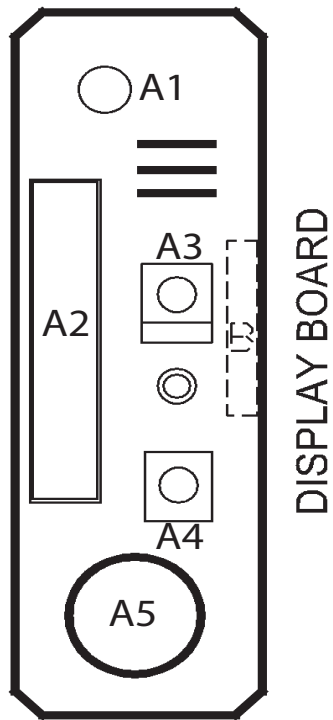

Applicable Model :
 FTKB18/24AXVJU
 FTXB18/24AXVJU

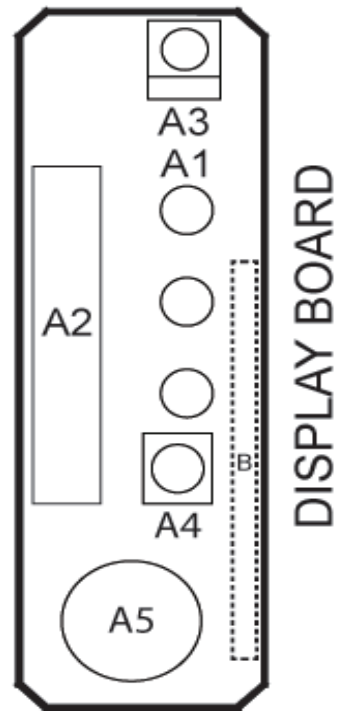

Applicable Model :
 FTKN18/24AXVJU
 FTXN18/24AXVJU

1.2.3 Outdoor PCB: RKB09/12AXVJU, RKN09/12AXVJU, RXB09/12AXVJU, RXN09/12AXVJU

1.2.3.1 Main PCB

Item	Indication on PCB	Description
1	S11	Connector for S10 on main PCB
2	HL1, HN1, S	Connector for terminal board
3	E1, E2	Terminal for earth wire
4	HL2, HN2	Connector for HL3 HN3 on main PCB
5	HL4, HN4	Connector for S12 on main PCB
6	FU1	Fuse (3.15A, 250V)
7	FU3	Fuse (30A, 250V)
8	V2, V3	Varistor

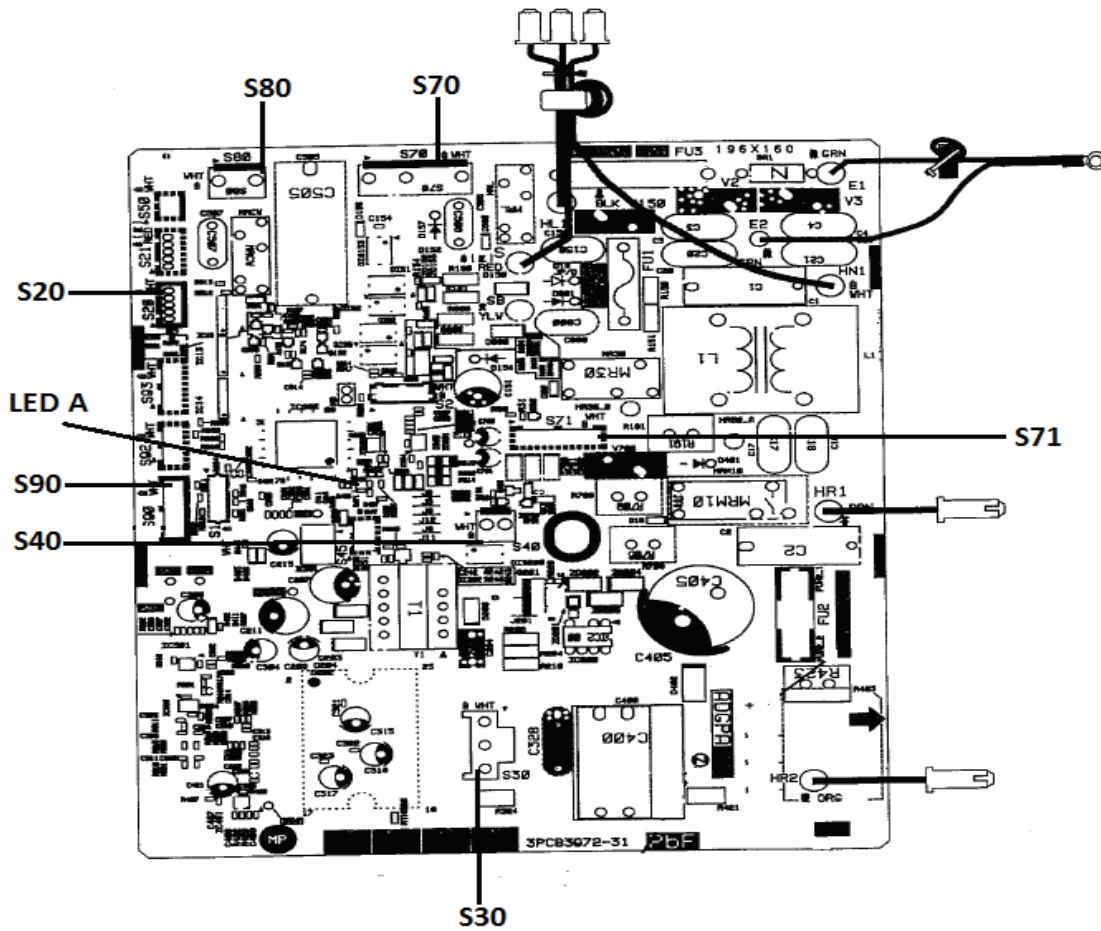

1.2.4 Outdoor PCB: RKB18/24AXVJU, RKN18/24AXVJU, RXB18/24AXVJU, RXN18/24AXVJU

1.2.4.1 Filter PCB

Item	Indication on PCB	Description
1	S11	Connector for indoor PCB
2	FU3	Fuse (20A)
3	V2, V3	Varistor

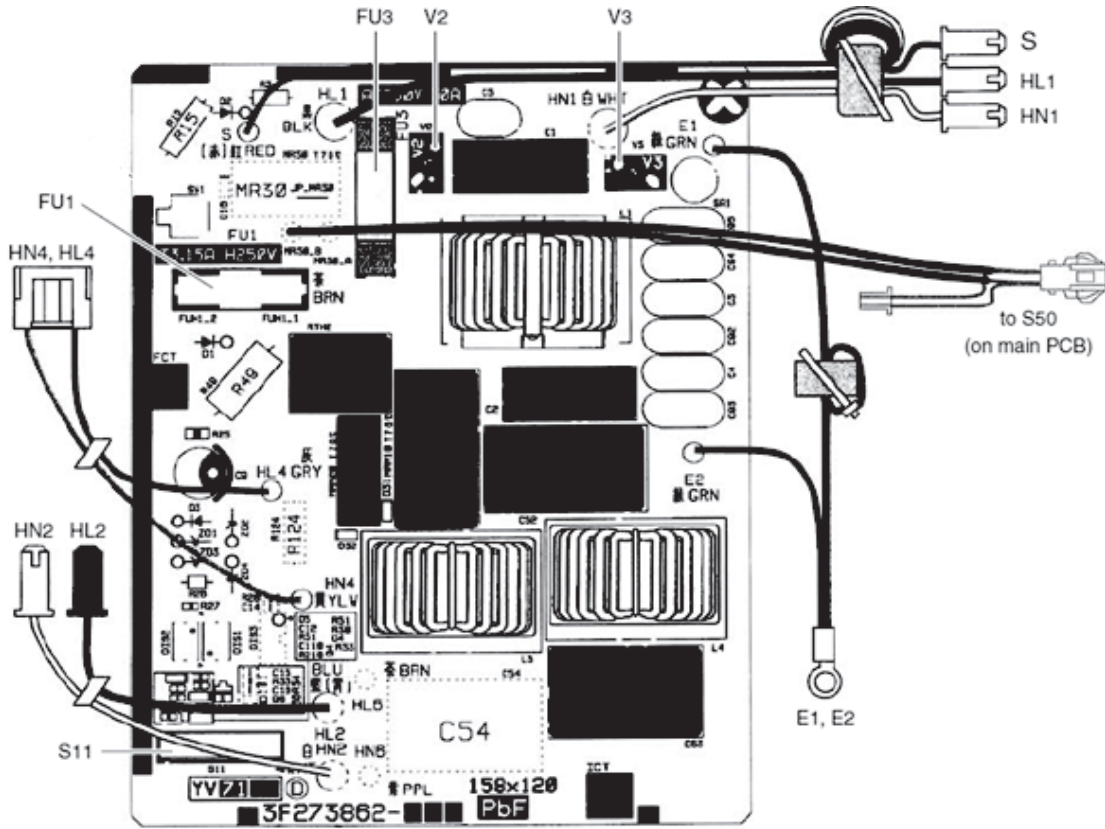

1.2.4.2 Main PCB

Item	Indication on PCB	Description
1	S10	Connector for filter PCB
2	S20	Connector for electronic expansion valve coil
3	S40	Connector for overload protector
4	S70	Connector for fan motor
5	S80	Connector for four way valve coil
6	S90	Connector for thermistors (outdoor temperature, outdoor heat exchanger, discharge pipe)
7	HL3, HN3	Connector for filter PCB
8	FU1, FU2	Fuse (3.15A)
9	LED A	Service monitor LED (green)
10	V1	Varistor

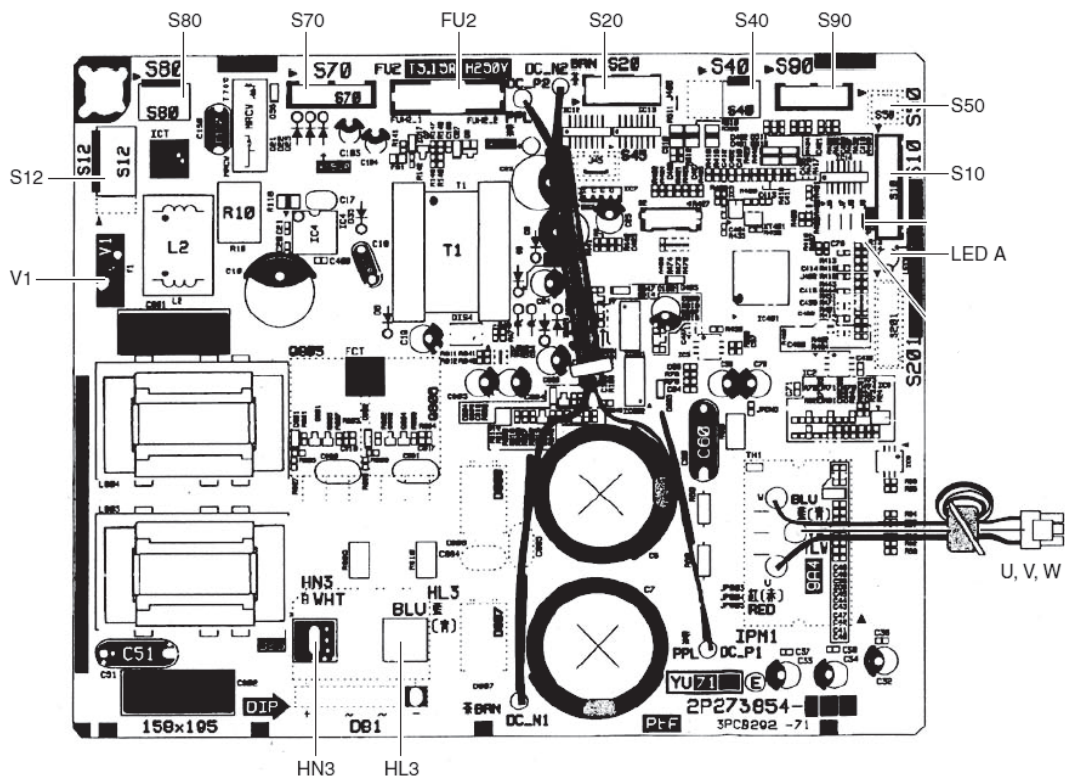

1.3 Piping Length & Elevation

Model	Max. total piping length, L [ft,(m)]	Max. height difference, E [ft,(m)]	Pre-charge for o to piping length [ft,(m)]	Additional charge [oz/ft (g/m)]
RK(X)B09AX RK(X)N09AX	65.6 (20)	32.8 (10)	25 (7.6)	0.21 (20)
RK(X)B12AX RK(X)N12AX	65.6 (20)	32.8 (10)	25 (7.6)	0.21 (20)
RK(X)B18AX RK(X)N18AX	98.4 (30)	32.8 (10)	25 (7.6)	0.21 (20)
RK(X)B24AX RK(X)N24AX	98.4 (30)	32.8 (10)	25 (7.6)	0.21 (20)

Remark : The refrigerant pre-charged in the outdoor unit is for piping length up to 25ft (7.6m).

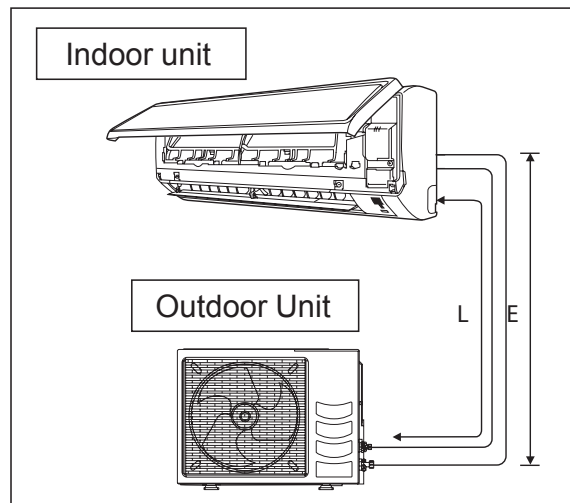

1.4 Outline & Dimension

1.4.1 Indoor Unit

Model: FTK(X)B09/12AX, FTK(X)N09/12AX

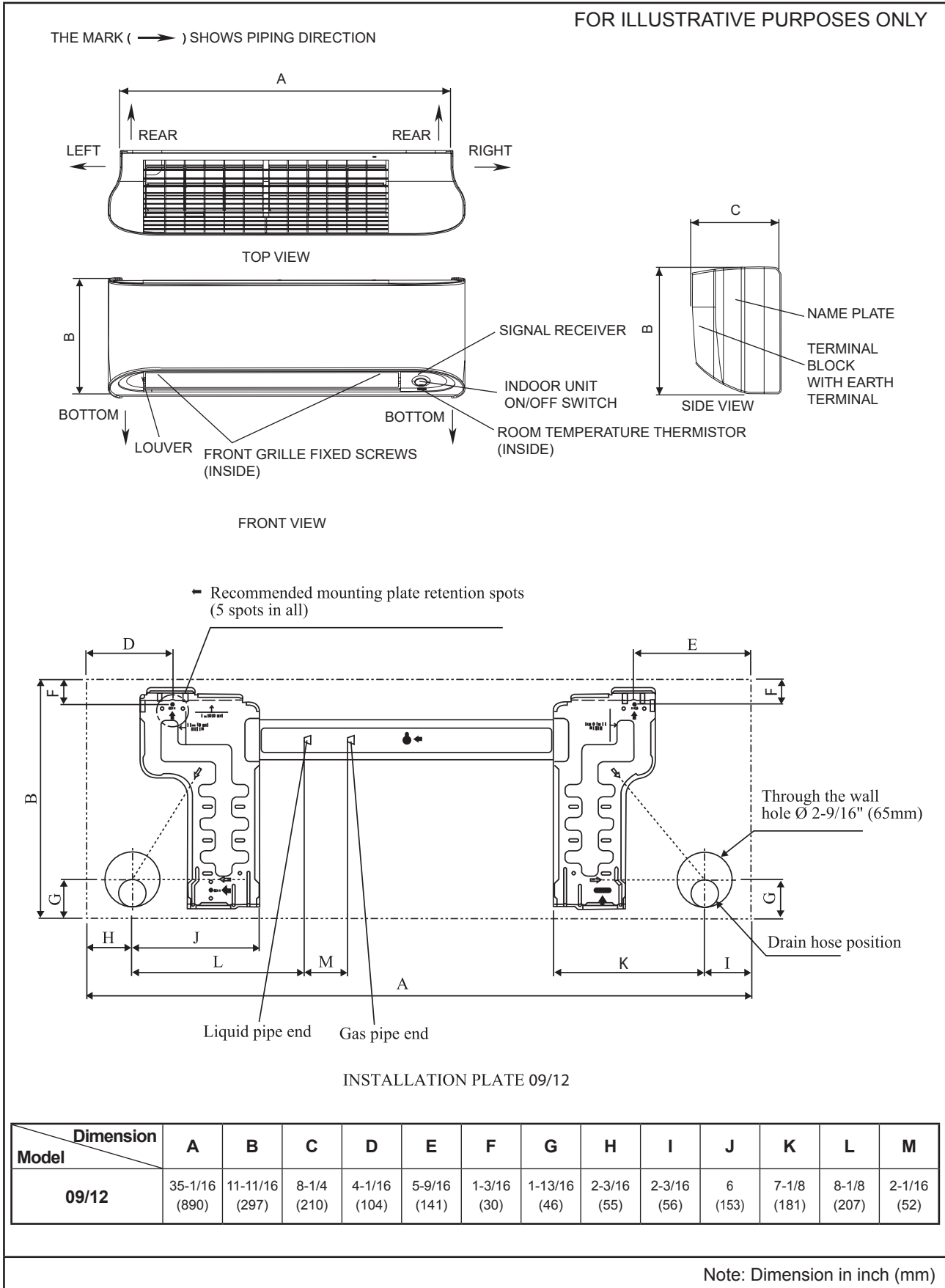

Model: FTK(X)B18/24AX, FTK(X)N18/24AX

FOR ILLUSTRATIVE PURPOSES ONLY

THE MARK (→) SHOWS PIPING DIRECTION

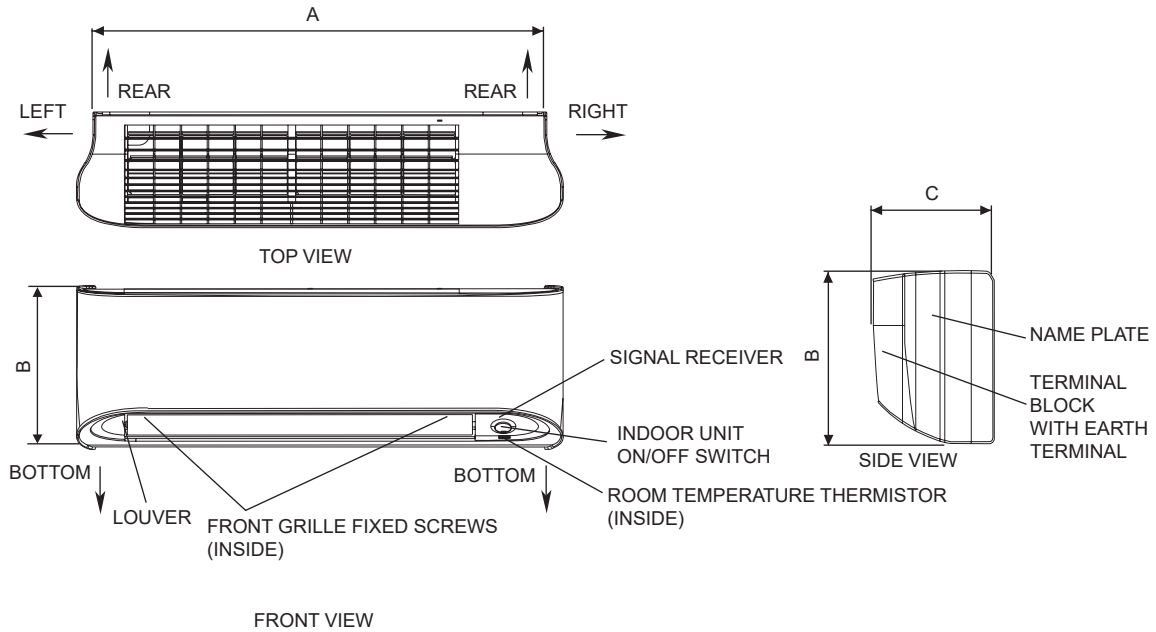

↑ Recommended mounting plate retention spots (7 spots in all)

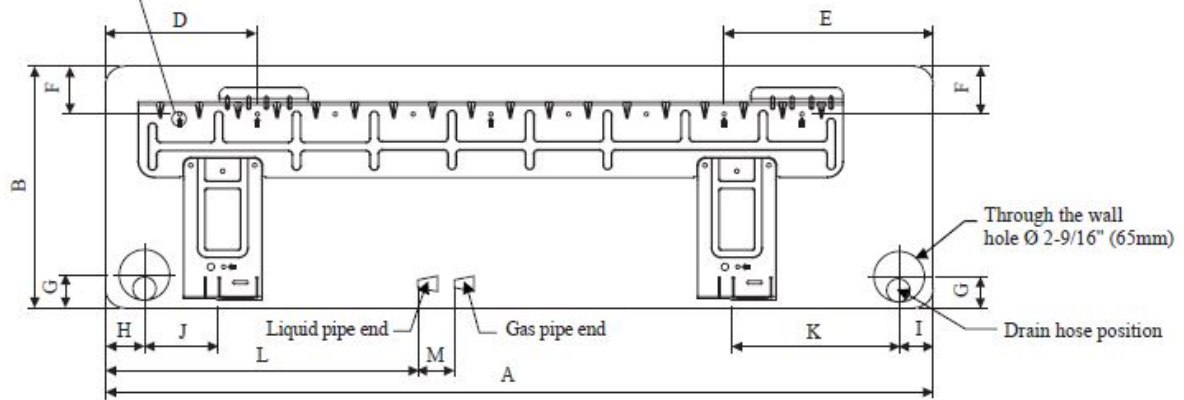

INSTALLATION PLATE 18/24

Model \ Dimension	A	B	C	D	E	F	G
18/24	46-1/8 (1172)	12-5/8 (320)	9-1/2 (242)	7-1/2 (190)	6-13/16 (173)	2-3/8 (61)	1-9/16 (40)

Model \ Dimension	H	I	J	K	L	M
18/24	1-3/4 (45)	1-7/8 (48)	3-9/16 (91)	8-5/8 (219)	22-13/16 (580)	1-3/4 (45)

Note: Dimension in inch (mm)

1.4.2 Outdoor Unit

Model: RK(X)B09/12AX, RK(X)N09/12AX

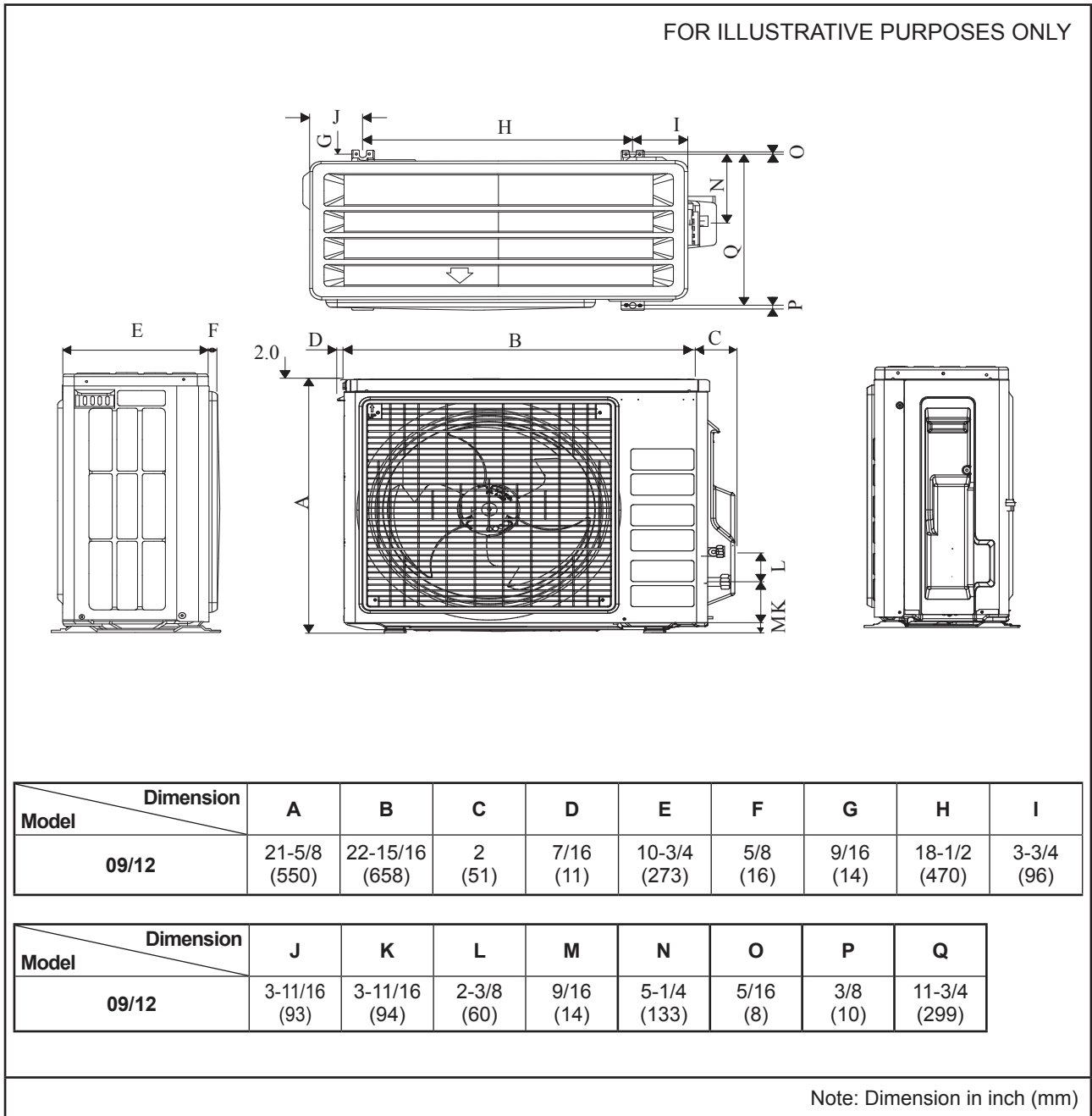

Model: RK(X)B18/24AX, RK(X)N18/24AX

FOR ILLUSTRATIVE PURPOSES ONLY

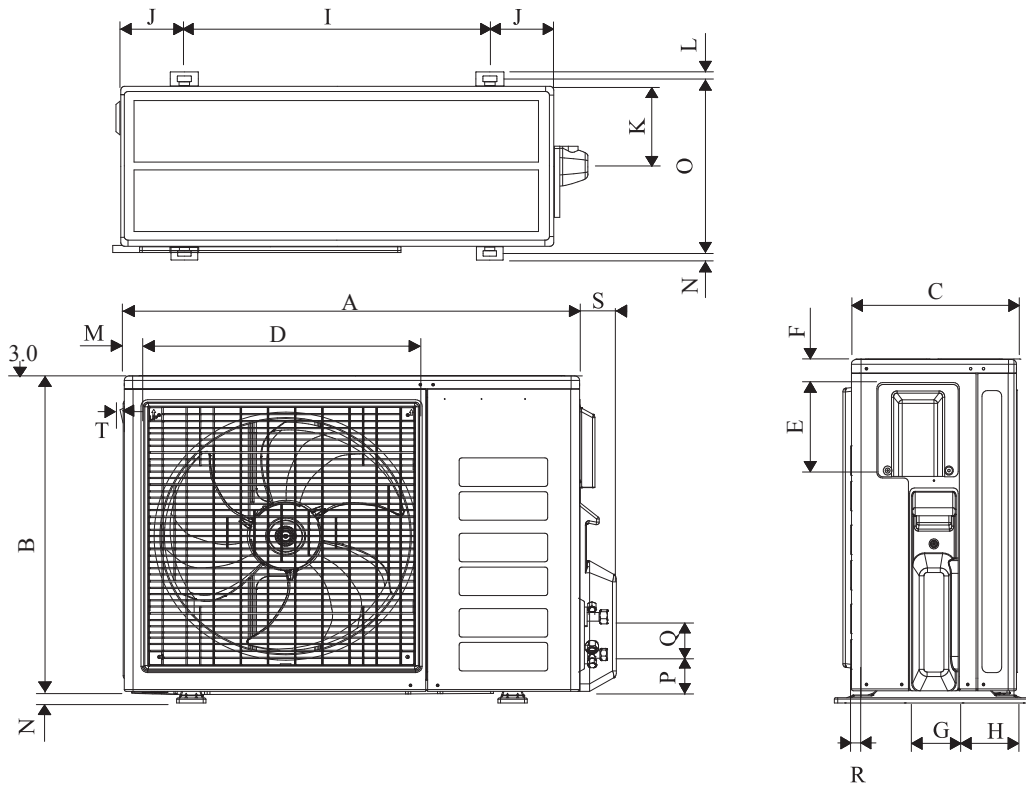

Dimension Model	A	B	C	D	E	F	G	H	I	J
18	33-11/16 (855)	24-3/4 (628)	12-15/16 (328)	20-1/2 (520)	7-1/16 (179)	1-13/16 (46)	4 (101)	4-7/16 (113)	23-3/4 (603)	4-15/16 (126)
24	33-11/16 (855)	28-3/4 (730)	12-15/16 (328)	20-1/2 (520)	7-1/16 (179)	1-13/16 (46)	4 (101)	4-7/16 (113)	23-3/4 (603)	4-15/16 (126)

Dimension Model	K	L	M	N	O	P	Q	R	S	T
18	6-7/16 (164)	9/16 (15)	1-5/16 (34)	15/16 (23)	14-1/4 (362)	2-7/8 (73)	2-15/16 (75)	5/16 (8)	2-5/8 (67)	1/4 (7)
24	6-7/16 (164)	9/16 (15)	1-5/16 (34)	15/16 (23)	14-1/4 (362)	2-7/8 (73)	2-15/16 (75)	5/16 (8)	2-5/8 (67)	1/4 (7)

Note: Dimension in inch (mm)

1.5 Engineering Data

1.5.1 Cooling Only

Model	Indoor unit		FTKB09AXVJU	FTKB12AXVJU	FTKB18AXVJU	FTKB24AXVJU	
	Outdoor unit		RKB09AXVJU	RKB12AXVJU	RKB18AXVJU	RKB24AXVJU	
Nominal Cooling Capacity (Min. ~ Max.)	Btu/h		8800 (4400 - 10200)	11000 (4400 - 13000)	18000 (4300 - 21200)	21200 (6000 - 22200)	
	W		2570 (1300 - 3000)	3220 (1300 - 3800)	5270 (1260 - 6200)	6210 (1750 - 6500)	
Nominal Total Input Power	W		800	1294	1710	1927	
Nominal Running Current	A		3.60	5.79	7.48	8.47	
SEER			17	17	17	17	
EER	(Btu/h)/W		11.00	8.50	10.50	11.00	
Power Supply	V/Ph/Hz		208/230/1/60	208/230/1/60	208/230/1/60	208/230/1/60	
INDOOR UNIT	Airflow (H/M/L/T/Q)		cfm	330/272/215/378/165	360/282/232/392/165	430/374/318/486/274	555/486/405/605/336
	Sound Pressure Level (H/M/L/T/Q)		dB(A)	42/35/30/43/23	42/35/32/43/22	40/37/35/43/32	47/44/41/49/37
	Height		in. (mm)	11-11/16 (297)	11-11/16 (297)	12-5/8 (320)	12-5/8 (320)
	Width		in. (mm)	35-1/16 (890)	35-1/16 (890)	46-1/8 (1172)	46-1/8 (1172)
	Depth		in. (mm)	8-1/4 (210)	8-1/4 (210)	9-1/2 (242)	9-1/2 (242)
	Machine Weight		lbs (kg)	20 (9)	20 (9)	31 (14)	31 (14)
OUTDOOR UNIT	Sound Pressure Level		dB(A)	46	48	53	52
	Height		in. (mm)	21-5/8 (550)	21-5/8 (550)	25-11/16 (651)	29-11/16 (753)
	Width		in. (mm)	25-15/16 (658)	25-15/16 (658)	33-11/16 (855)	33-11/16 (855)
	Depth		in. (mm)	10-3/4 (273)	10-3/4 (273)	12-15/16 (328)	12-15/16 (328)
	Machine Weight		lbs (kg)	53 (24)	57 (26)	82 (37)	97 (44)
Piping Connections	Liquid	in. (mm)	1/4 (6.35)	1/4 (6.35)	1/4 (6.35)	1/4 (6.35)	
	Gas	in. (mm)	3/8 (9.52)	3/8 (9.52)	1/2 (12.70)	5/8 (15.88)	
Operation Range	°F		50 ~115	50 ~115	14 ~115	14 ~115	

Model	Indoor unit		FTKN09AXVJU	FTKN12AXVJU	FTKN18AXVJU	FTKN24AXVJU	
	Outdoor unit		RKN09AXVJU	RKN12AXVJU	RKN18AXVJU	RKN24AXVJU	
Nominal Cooling Capacity (Min. ~ Max.)	Btu/h		8800 (4400 - 10200)	11000 (4400 - 13000)	18000 (4300 - 21200)	21200 (6000 - 22200)	
	W		2570 (1300 - 3000)	3220 (1300 - 3800)	5270 (1260 - 6200)	6210 (1750 - 6500)	
Nominal Total Input Power	W		800	1294	1710	1927	
Nominal Running Current	A		3.60	5.79	7.48	8.47	
SEER			17	17	17	17	
EER	(Btu/h)/W		11.00	8.50	10.50	11.00	
Power Supply	V/Ph/Hz		208/230/1/60	208/230/1/60	208/230/1/60	208/230/1/60	
INDOOR UNIT	Airflow (H/M/L/T/Q)		cfm	330/272/215/378/165	360/282/232/392/165	430/374/318/486/274	555/486/405/605/336
	Sound Pressure Level (H/M/L/T/Q)		dB(A)	42/35/30/43/23	42/35/32/43/22	40/37/35/43/32	47/44/41/49/37
	Height		in. (mm)	11-5/16 (288)	11-5/16 (288)	12-3/16 (310)	12-3/16 (310)
	Width		in. (mm)	33-13/16 (859)	33-13/16 (859)	44-1/4 (1124)	44-1/4 (1124)
	Depth		in. (mm)	8-1/4 (209)	8-1/4 (209)	9-5/16 (237)	9-5/16 (237)
	Machine Weight		lbs (kg)	20 (9)	20 (9)	31 (14)	31 (14)
OUTDOOR UNIT	Sound Pressure Level		dB(A)	46	48	53	52
	Height		in. (mm)	21-5/8 (550)	21-5/8 (550)	25-11/16 (651)	29-11/16 (753)
	Width		in. (mm)	25-15/16 (658)	25-15/16 (658)	33-11/16 (855)	33-11/16 (855)
	Depth		in. (mm)	10-3/4 (273)	10-3/4 (273)	12-15/16 (328)	12-15/16 (328)
	Machine Weight		lbs (kg)	53 (24)	57 (26)	82 (37)	97 (44)
Piping Connections	Liquid	in. (mm)	1/4 (6.35)	1/4 (6.35)	1/4 (6.35)	1/4 (6.35)	
	Gas	in. (mm)	3/8 (9.52)	3/8 (9.52)	1/2 (12.70)	5/8 (15.88)	
Operation Range	°F		50 ~115	50 ~115	14 ~115	14 ~115	

1.5.2 Heatpump

Model	Indoor unit		FTXB09AXVJU	FTXB12AXVJU	FTXB18AXVJU	FTXB24AXVJU
	Outdoor unit		RXB09AXVJU	RXB12AXVJU	RXB18AXVJU	RXB24AXVJU
Nominal Cooling Capacity (Min. ~ Max.)	Btu/h		8800 (4400 - 10200)	11000 (4400 - 13000)	18000 (4300 - 21200)	21200 (6000 - 22200)
	W		2570 (1300 - 3000)	3220 (1300 - 3800)	5270 (1260 - 6200)	6210 (1750 - 6500)
Nominal Heating Capacity (Min. ~ Max.)	Btu/h		9400 (4400 - 13600)	11300 (4400 - 16200)	17900 (4000 - 22500)	21200 (4100 - 27300)
	W		2750 (1300 - 4000)	3310 (1300 - 4750)	5240 (1170 - 6600)	6210 (1200 - 8000)
Nominal Total Input Power (Cooling)	W		800	1294	1710	1927
Nominal Total Input Power (Heating)	W		774	1004	1590	1688
Nominal Running Current (Cooling)	A		3.60	5.79	7.48	8.47
Nominal Running Current (Heating)	A		3.51	4.60	7.03	7.56
SEER			17	17	17	17
EER		(Btu/h)/W	11.00	8.50	10.50	11.00
COP		(Btu/h)/W	12.15	11.26	11.26	12.56
HSPF			9	9	9	9
Power Supply		V/Ph/Hz	208/230/1/60	208/230/1/60	208/230/1/60	208/230/1/60
INDOOR UNIT	Airflow (H/M/L/T/Q) (Cooling)	cfm	330/272/215/378/165	360/282/232/392/165	430/374/318/486/274	555/486/405/605/336
	Airflow (H/M/L/T/Q) (Heating)	cfm	330/272/215/378/165	360/282/232/392/165	435/374/318/486/274	580/486/405/605/336
	Sound Pressure Level (H/M/L/T/Q)	dB(A)	42/35/30/43/23	42/35/32/43/22	40/37/35/43/32	47/44/41/49/37
	Height	in. (mm)	11-11/16 (297)	11-11/16 (297)	12-5/8 (320)	12-5/8 (320)
	Width	in. (mm)	35-1/16 (890)	35-1/16 (890)	46-1/8 (1172)	46-1/8 (1172)
	Depth	in. (mm)	8-1/4 (210)	8-1/4 (210)	9-1/2 (242)	9-1/2 (242)
	Machine Weight	lbs (kg)	20 (9)	20 (9)	31 (14)	31 (14)
OUTDOOR UNIT	Sound Pressure Level	dB(A)	46	48	53	52
	Height	in. (mm)	21-5/8 (550)	21-5/8 (550)	25-11/16 (651)	29-11/16 (753)
	Width	in. (mm)	25-15/16 (658)	25-15/16 (658)	33-11/16 (855)	33-11/16 (855)
	Depth	in. (mm)	10-3/4 (273)	10-3/4 (273)	12-15/16 (328)	12-15/16 (328)
	Machine Weight	lbs (kg)	53 (24)	57 (26)	82 (37)	97 (44)
Piping Connections	Liquid	in. (mm)	1/4 (6.35)	1/4 (6.35)	1/4 (6.35)	1/4 (6.35)
	Gas	in. (mm)	3/8 (9.52)	3/8 (9.52)	1/2 (12.70)	5/8 (15.88)
Operation Range	Cooling	°F	50 ~115	50 ~115	14 ~115	14 ~115
	Heating	°F	5 ~ 64.4	5 ~ 64.4	5 ~ 64.4	5 ~ 64.4

Model	Indoor unit		FTXN09AXVJU	FTXN12AXVJU	FTXN18AXVJU	FTXN24AXVJU
	Outdoor unit		RXN09AXVJU	RXN12AXVJU	RXN18AXVJU	RXN24AXVJU
Nominal Cooling Capacity (Min. ~ Max.)	Btu/h		8800 (4400 - 10200)	11000 (4400 - 13000)	18000 (4300 - 21200)	21200 (6000 - 22200)
	W		2570 (1300 - 3000)	3220 (1300 - 3800)	5270 (1260 - 6200)	6210 (1750 - 6500)
Nominal Heating Capacity (Min. ~ Max.)	Btu/h		9400 (4400 - 13600)	11300 (4400 - 16200)	17900 (4000 - 22500)	21200 (4100 - 27300)
	W		2750 (1300 - 4000)	3310 (1300 - 4750)	5240 (1170 - 6600)	6210 (1200 - 8000)
Nominal Total Input Power (Cooling)	W		800	1294	1710	1927
Nominal Total Input Power (Heating)	W		774	1004	1590	1688
Nominal Running Current (Cooling)	WWA		3.60	5.79	7.48	8.47
Nominal Running Current (Heating)	A		3.51	4.60	7.03	7.56
SEER			17	17	17	17
EER		(Btu/h)/W	11.00	8.50	10.50	11.00
COP		(Btu/h)/W	12.15	11.26	11.26	12.56
HSPF			9	9	9	9
Power Supply		V/Ph/Hz	208/230/1/60	208/230/1/60	208/230/1/60	208/230/1/60
INDOOR UNIT	Airflow (H/M/L/T/Q) (Cooling)	cfm	330/272/215/378/165	360/282/232/392/165	430/374/318/486/274	555/486/405/605/336
	Airflow (H/M/L/T/Q) (Heating)	cfm	330/272/215/378/165	360/282/232/392/165	435/374/318/486/274	580/486/405/605/336
	Sound Pressure Level (H/M/L/T/Q)	dB(A)	42/35/30/43/23	42/35/32/43/22	40/37/35/43/32	47/44/41/49/37
	Height	in. (mm)	11-5/16 (288)	11-5/16 (288)	12-3/16 (310)	12-3/16 (310)
	Width	in. (mm)	33-13/16 (859)	33-13/16 (859)	44-1/4 (1124)	44-1/4 (1124)
	Depth	in. (mm)	8-1/4 (209)	8-1/4 (209)	9-5/16 (237)	9-5/16 (237)
	Machine Weight	lbs (kg)	20 (9)	20 (9)	31 (14)	31 (14)
OUTDOOR UNIT	Sound Pressure Level	dB(A)	46	48	53	52
	Height	in. (mm)	21-5/8 (550)	21-5/8 (550)	25-11/16 (651)	29-11/16 (753)
	Width	in. (mm)	25-15/16 (658)	25-15/16 (658)	33-11/16 (855)	33-11/16 (855)
	Depth	in. (mm)	10-3/4 (273)	10-3/4 (273)	12-15/16 (328)	12-15/16 (328)
	Machine Weight	lbs (kg)	53 (24)	57 (26)	82 (37)	97 (44)
Piping Connections	Liquid	in. (mm)	1/4 (6.35)	1/4 (6.35)	1/4 (6.35)	1/4 (6.35)
	Gas	in. (mm)	3/8 (9.52)	3/8 (9.52)	1/2 (12.70)	5/8 (15.88)
Operation Range	Cooling	°F	50 ~115	50 ~115	14 ~115	14 ~115
	Heating	°F	5 ~ 64.4	5 ~ 64.4	5 ~ 64.4	5 ~ 64.4

2.0 Function & Control

2.1 Temperature Control

The temperature is detected by the room temperature thermistor (either on the unit or on the wired panel). The set temperature can be selected either through remote controller or wired controller by user.

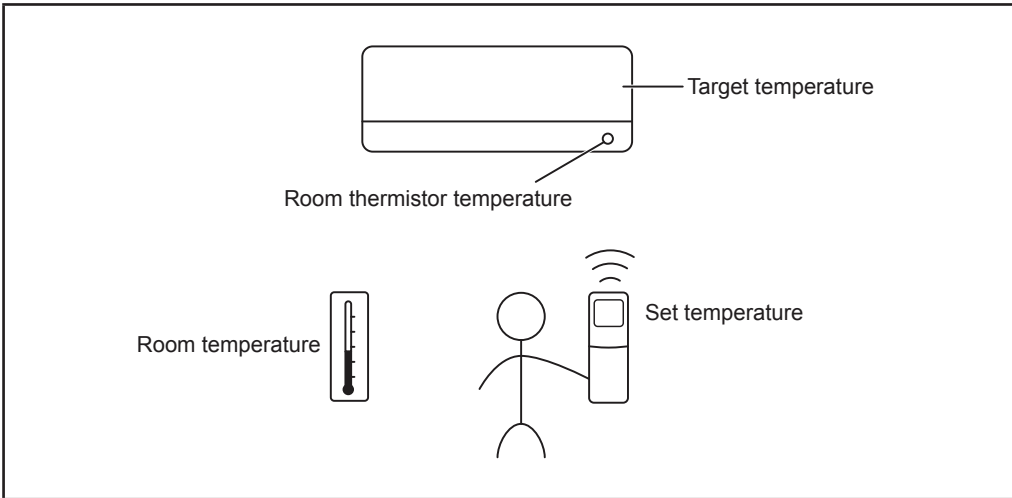

2.2 Cooling and Heating Mode Operation

The system has 5 operating modes. The mode selection is done through the indoor by using the remote controller.

The operating modes are:

- Cool
- Heat
- Fan
- Auto
- Dry

2.2.1 Cooling Mode

When $T_r \geq T_s + 1.5^\circ\text{C}$ (2.7°F)

- Compressor, Indoor Fan and Outdoor Fan ON.

When $T_r \leq T_s - 2^\circ\text{C}$ (3.6°F)

- Compressor and Outdoor Fan OFF. Indoor Fan remained ON.

T_r = Room Temperature

T_s = Set Temperature

When cooling load is too small and the room temperature still drops below compressor cut off point, compressor will stop.

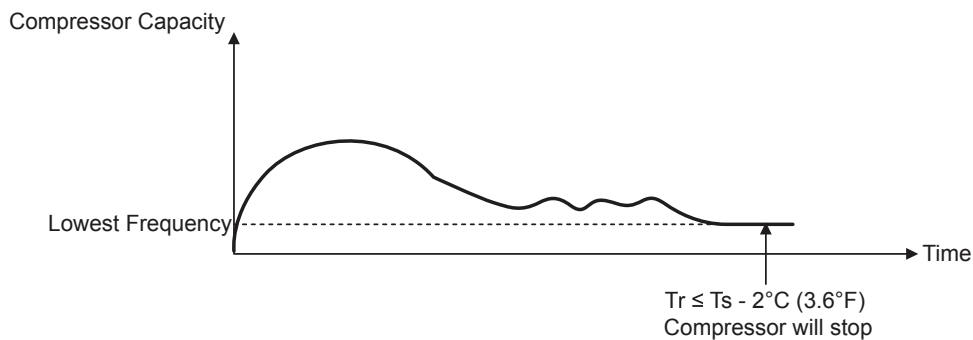

2.2.2 Heating Mode:

When $T_s > T_r - 1.0^\circ\text{C}$ (1.8°F)

- Compressor, Indoor Fan and Outdoor Fan ON.

When $T_s \leq T_r - 1.5^\circ\text{C}$ (2.7°F)

- Compressor and Outdoor Fan OFF. Indoor Fan speed will change to Super Low.

T_r = Room Temperature

T_s = Set Temperature

When heating load is too small, and the room temperature is still rising above compressor cut off point, compressor will stop.

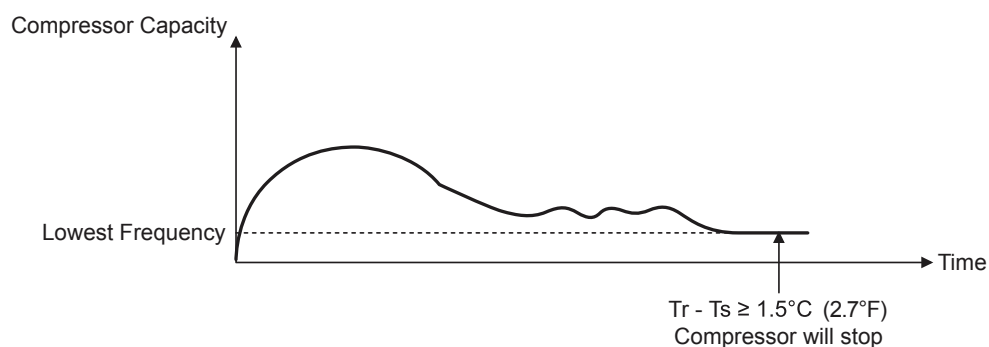

2.3 Dry Mode

Program dry operation removes humidity while preventing the room temperature from lowering. Since the microcomputer controls both the temperature and airflow rate, the temperature adjustment and FAN setting buttons are inoperable.

The microcomputer automatically sets the temperature and airflow rate. The difference between the room thermistor temperature at start-up and the target temperature is divided into two zones. Then, the unit operates in an appropriate capacity for each zone to maintain the temperature and humidity at a comfortable level.

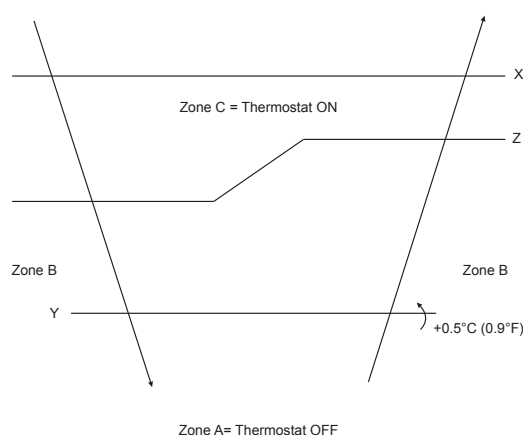

Target temperature X	Thermostat OFF point Y	Thermostat ON point Z*
Setting temperature	Room thermistor temperature – X = -2°C (3.6°F)	Room thermistor temperature – X = -0.5°C (0.9°F)

*Thermostat turns on also when the room temperature is in the zone B for 2 minutes.

2.4 Fan Mode

- Compressor and Outdoor Fan OFF. Indoor Fan remains ON.
- Only High, Medium and Low fan speeds are allowed.
- When changing cool mode to fan mode, the compressor will stop and outdoor fan stops based on fan OFF control.
- Compressor only ON if the minimum stop time is > 3 minutes and the user change back to cool mode.
- Fan speed will maintain same as during fan mode.

2.5 Auto Mode

Automatic Cooling / Heating Function

When the automatic operation is selected with the remote controller, the microcomputer automatically determines the operation mode as cooling or heating according to the room temperature and the set temperature at start-up.

The unit automatically switches the operation mode to maintain the room temperature at the set temperature.

For heat pump only

Mode switching point:

- From Heating to Cooling
 $T_r \geq T_s + 2.5^\circ\text{C}$ (4.5°F)
- From Cooling to Heating
 $T_r \leq T_s - 2.5^\circ\text{C}$ (4.5°F)

During initial operation

- Cooling operation: $T_r > T_s$
- Heating operation: $T_r < T_s$

2.6 Cold Draft Prevention

During each thermal cut in cycle, the indoor fan speed will modulate according to the indoor heat exchanger temperature shown as below:

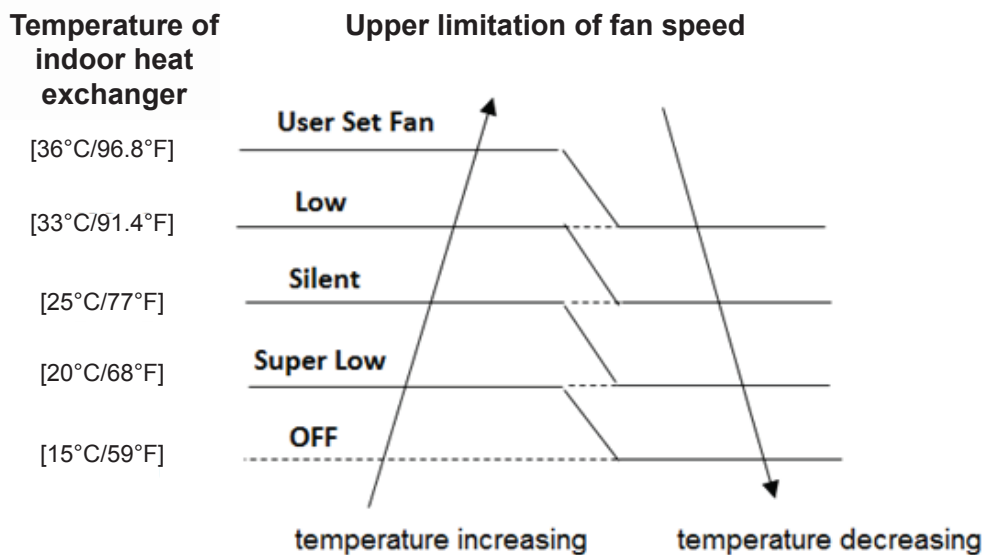

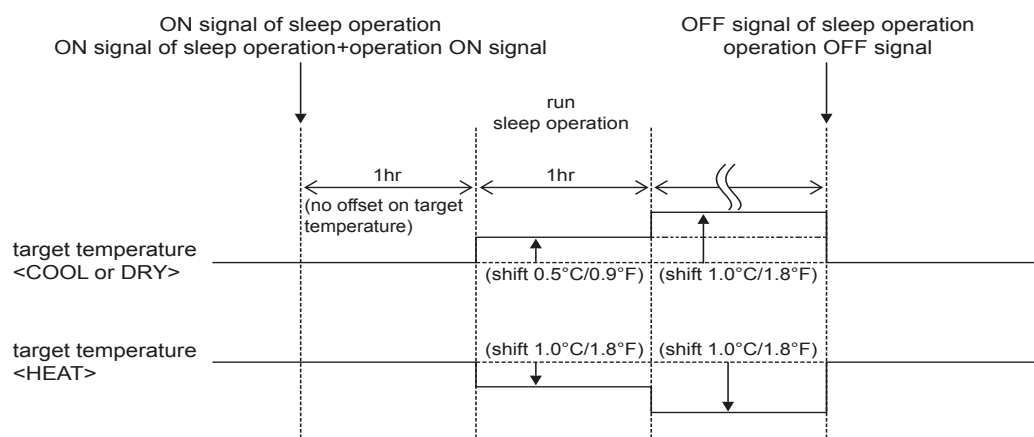

2.7 Sleep Mode

SLEEP Mode can be activated through the remote controller to keep the thermal comfort while sleeping. SLEEP Mode continues operation at the target temperature for the first hour, then automatically raises the target temperature slightly in case of cooling, or lowers it slightly in case of heating. This prevents excessive cooling in summer and excessive heating in winter to ensure comfortable sleeping conditions, and also saves electricity.



2.8 Quiet function

- Press  for quiet operation (for FTK(X)B-AX models) or  (for FTK(X)N-AX models) for quiet operation
- Fan speed turns to minimum speed.
- Press again to deactivate the function.
- Available in HEAT and COOL modes only.
- Any change of fan speed will deactivate this function.

2.9 ECO+ function (Applicable for FTK(X)B-AX models)

- Press  for eco-friendly mode cooling or heating operation.
- Set temperature automatically adjusts to eco-friendly level.
- Press again to deactivate the function.
- Available in HEAT and COOL modes only.

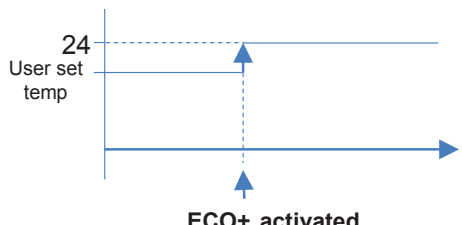
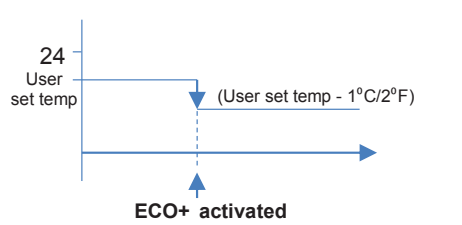
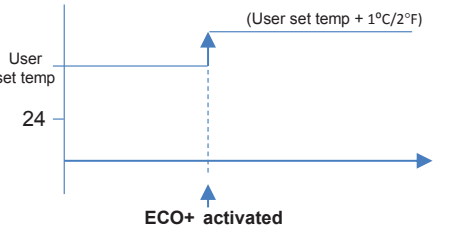
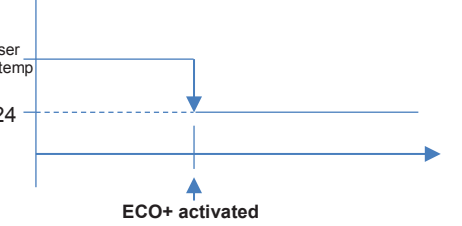
	Cool mode	Heat mode
User set temperature < 24°C (75°F)	Unit runs at 24°C (75°F) 	Unit runs at (user set temperature - 1°C/2°F) 
User set temperature = 24°C (75°F)	Unit runs at 24°C (75°F)	Unit runs at 24°C (75°F)
User set temperature > 24°C (75°F)	Unit runs at (user set temperature + 1°C/2°F) 	Unit runs at 24°C (75°F) 

2.10 Powerful function

- Press  (for FTK(X)B-AX models) or “**TURBO**” for (FTK(X)N-AX models) for powerful mode.
- When POWERFUL/TURBO button is pressed, the fan speed will run at maximum speed for 20 minutes.
- Press again to deactivate the function.
- Available in HEAT and COOL modes only.

Operation Mode	Fan Speed	Target Temperature
COOL	Current Tap + A rpm	Current set temperature -4°C (7.2°F)
HEAT	Current Tap + B rpm	Current set temperature -6°C (10.8°F)

Class 09/12: A = 100 rpm B = 100 rpm

Class 18: A = 90 rpm B = 50 rpm

Class 24: A = 80 rpm B = 50 rpm

2.11 Indoor-Outdoor Communication

Master by outdoor unit.

Outdoor controller board will transmit signal to Indoor controller board. Indoor unit will response to outdoor once the valid data is received.

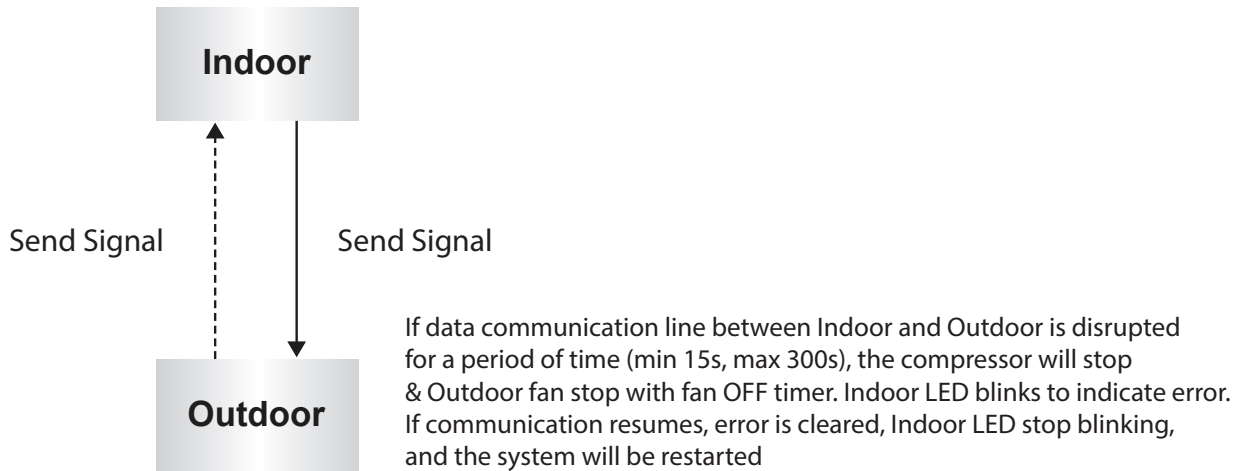

Communication between indoor and outdoor equipment, terminal 1 to ground 120 VAC, 2 to ground 120 VAC, SIG to ground 120 VAC, between 1 & 2 208/230 VAC, between 2 & 3 0 VAC but 5 to 45 VDC fluctuating signal.

2.12 Thermistors in RK(X)B, RK(X)N

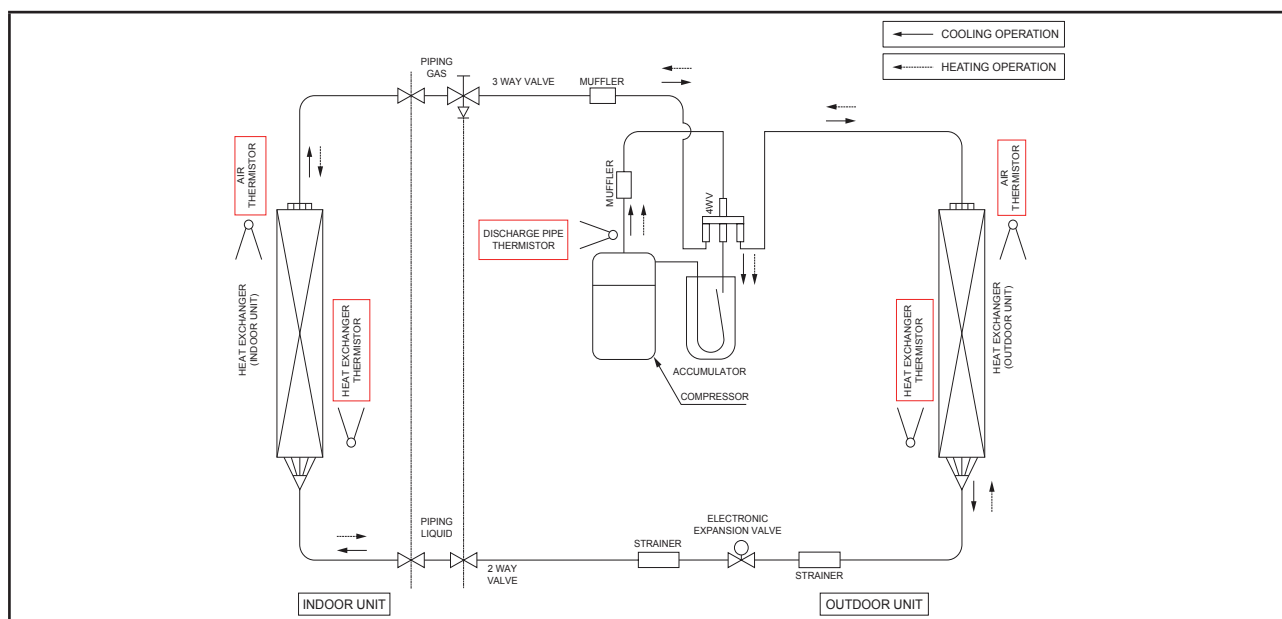

Functions of Thermistor

Thermistor	Functions
Discharge pipe	<ol style="list-style-type: none"> 1. The discharge pipe thermistor is used for controlling discharge pipe temperature. If the discharge pipe temperature (used in place of the inner temperature of the compressor) rises abnormally, the operating frequency becomes lower or the operation halts. 2. The discharge pipe thermistor is used for detecting disconnection of the discharge pipe thermistor.
Outdoor heat exchanger	<ol style="list-style-type: none"> 1. The outdoor heat exchanger thermistor is used for controlling the target discharge pipe temperature. The system sets the target discharge pipe temperature according to the outdoor and indoor heat exchanger temperature, and controls the Electronic Expansion Valve (EXV) opening so that the target discharge pipe temperature can be obtained. 2. In cooling operation, the outdoor heat exchanger thermistor is used for detecting the disconnection of the discharge pipe thermistor. When the discharge pipe temperature drops below the outdoor heat exchanger temperature by more than a certain value, the discharge pipe thermistor is judged as disconnected. 3. In cooling operation, the outdoor heat exchanger thermistor is used for high pressure protection.
Indoor heat exchanger	<ol style="list-style-type: none"> 1. The indoor heat exchanger thermistor is used for controlling the target discharge pipe temperature. The system sets the target discharge pipe temperature according to the outdoor and indoor heat exchanger temperature, and controls the Electronic Expansion Valve (EXV) opening so that the target discharge pipe temperature can be obtained. 2. In cooling operation, the indoor heat exchanger thermistor is used for freeze-up protection control. If the indoor heat exchanger temperature drops abnormally, the operating frequency becomes lower or the operation halts. 3. In heating operation, the indoor heat exchanger thermistor is used for detecting the disconnection of the discharge pipe thermistor. When the discharge pipe temperature drops below the indoor heat exchanger temperature by more than a certain value, the discharge pipe thermistor is judged as disconnected.
Outdoor air	<ol style="list-style-type: none"> 1. Used for defrost & outdoor fan speed control. 2. Used for overall current protection & preheating operation control.
Heat sink	<ol style="list-style-type: none"> 1. Used for capturing heat sink temperature. (Applicable for Daikin controller)
Suction pipe	<ol style="list-style-type: none"> 1. Used for Electronic Expansion Valve (EXV) & suction pipe (SH) protection control in heating.

2.13 Minimum Off Time Control

To prevent frequent compressor ON/OFF & to allow pressure equalization

- The compressor will be on 3 minutes stand-by after turning OFF before it is allowed to turn ON.
- Outdoor fan OFF delay to improve pressure equalization & to prevent refrigerant from entering into evaporator.

2.14 Auto Restart

Factory pre-set.

Allow unit to automatically resume the same operating mode it was in before a power failure.

To disable the auto random restart function, cut off the jumper J_AUTO as highlighted in attachment.

Please be informed that after disable auto restart function, unit is not able to restart with last state memory after power resume from failure.

2.15 Auto Random Restart

Unit restarts automatically in 64 different recovery timing patterns (within 180 seconds to 244 seconds) and operates based on the previous setting (operating mode, temperature setting and fan speed).

To disable the auto random restart function, cut off the jumper J_AUTO as highlighted in attachment.

Please be informed that after disable auto random restart, unit is not able to restart with last state memory after power resume from failure. Unit will revert to default setting as below:

Default setting

Unit: Off

Temperature: 24°C (75°F)

Fan speed: High

Mode: Cooling

Applicable for PCB W_2_03D , W_2_03E & W_2_03E_M (For all class 09/12)

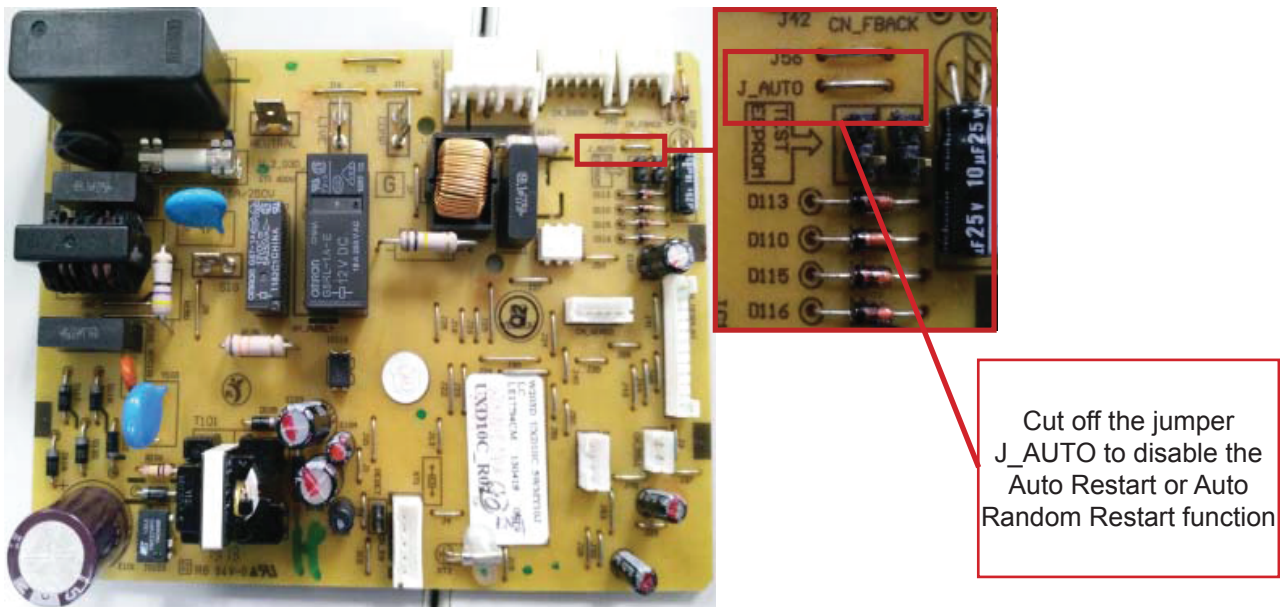

Applicable for PCB W_2_04A & W_2_04B (For all class 18/24)

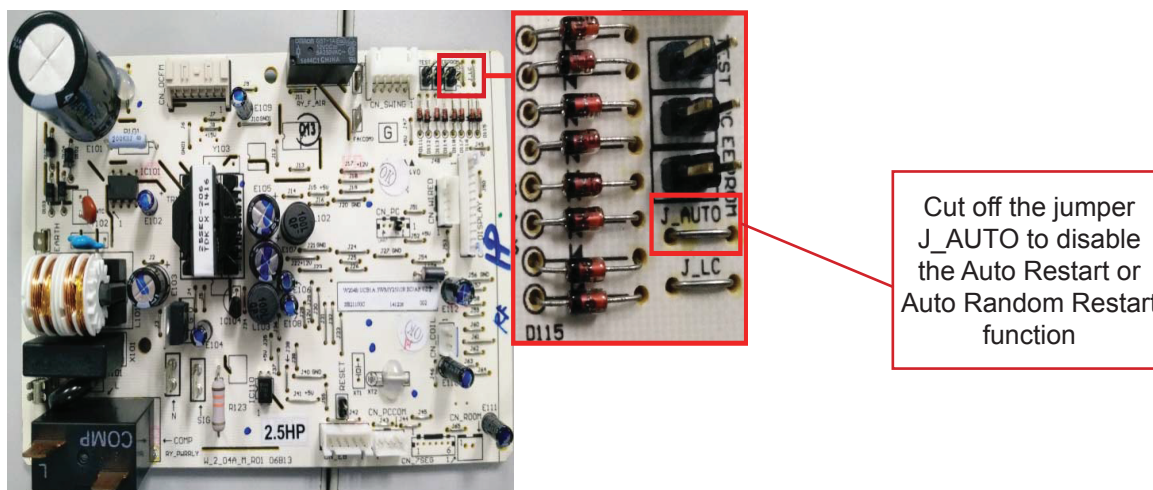

2.16 Four Way Valve Control

Change over switching is only carried out during operation.

OFF delayed is applied when the coil switches from ON to OFF

Operating mode	4-way valve is
Heat, except for defrost	ON
Cool Dry Defrost	OFF

2.17 Outdoor Fan Control

a) Fan ON control to cool down the electrical box

The outdoor fan is turned ON when the electrical box temperature is high while the compressor is OFF.

b) Fan OFF control during defrosting

The outdoor fan is turned OFF during defrosting

c) Fan OFF delay when stopped

The outdoor fan is turned OFF 60 – 70 seconds after the compressor stops

d) Fan speed control for pressure difference upkeep

The rotation speed of the outdoor fan is controlled for keeping the pressure difference during cooling operation with low outdoor temperature

- When the pressure difference is low, the rotation speed of the outdoor fan is reduced

- When the pressure difference is high, the rotation speed of the outdoor fan is controlled as well as normal operation

e) Fan speed control during forced cooling operation

The outdoor fan is controlled as well as normal operation during forced cooling operation

f) Fan speed control during POWERFUL/TURBO operation

The rotation speed of the outdoor fan is increased during POWERFUL/TURBO operation

g) Fan speed control during indoor unit quiet operation

The rotation speed of the outdoor fan is reduced by the command of the indoor unit quiet operation

h) Fan ON/OFF control when operation (cooling, heating, dry) starts/stops

The outdoor fan is turned ON when the operation starts. The outdoor fan is turned OFF when the operation stops

2.18 Rotation Regulating Functions

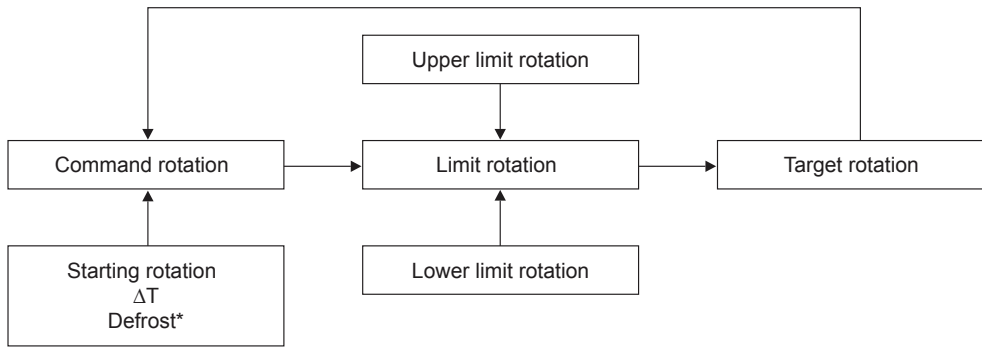

* Defrost control for heat pump model only

2.18.1 Starting Rotation

Starting Control

To avoid excessive oil discharge from compressor or to promote oil lubrication during startup.

To prevent liquid flood back to the compressor.

To limit starting current.

When compressor starts to rotate from OFF to ON, compressor rotation is set to run gradually to each upper limit at a specific timer setting.

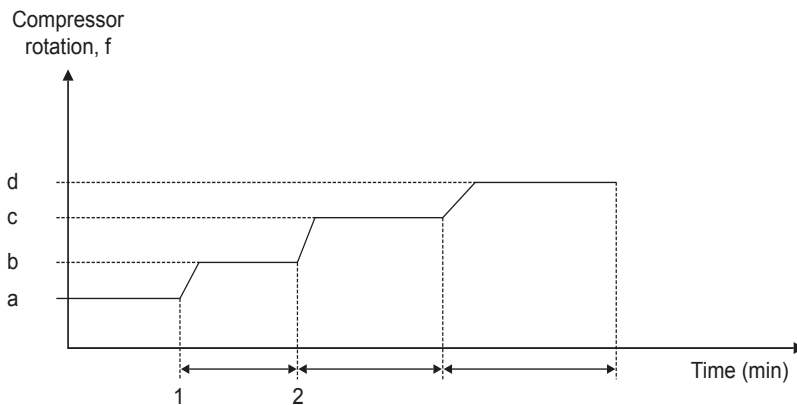

Model	a Hz (Time, s)	b Hz (Time, s)	c Hz (Time, s)	d Hz (Time, s)	Max Hz (Time, s)
RK(X)B09/12AXVJU RK(X)N09/12AXVJU	40 (180)	54 (420)	72 (180)	90 (120)	-
RK(X)B18/24AXVJU RK(X)N18/24AXVJU	55 (120)	70 (200)	85 (470)	-	-

2.18.2 Command Rotation

Cut in upon termination of Starting Control.

Achieve capacity control by controlling the compressor rotation based on:

- Temperature difference between set and room temperature, ΔT .
- Limit Rotation.
- Defrost control.

2.18.3 Limit Rotation

Determine from

- Upper limit rotation

A minimum value was determined among the upper limits rotation, i.e. protection controls.

- Lower limit rotation

A maximum value was determined among the lower limits rotation, i.e. protection controls.

Generally, compressor rotation is controlled within 5 zones: stop, drop, keep, up and reset subjected to a particular operating temperature/current/pressure.

Zone	Control
Stop	Compressor is stopped when a certain limit reaches the stop zone for abnormality correction.
Drop	Frequency will be dropped with a timer setting.
Keep	Frequency is maintained at lower/upper limit.
Up	Frequency will be increased with a timer setting.
Reset	Frequency lower/upper limit is canceled and returned to command rotation.

2.19 Defrost Cycle

Defrosting is carried out by the cooling cycle (reverse cycle). The defrosting time or outdoor heat exchanger temperature must be more than a certain value to finish defrosting.

During defrost	All models
Compressor	ON
4-way valve	OFF
EXV in operation room	Fixed opening
Outdoor fan	OFF
Indoor fan	OFF

Conditions for starting Defrost

- The starting conditions are determined with the outdoor temperature and the outdoor heat exchanger temperature
- The system is in heating condition
- Compressor minimum run time – 6 minutes OR
- More than A minutes (depending on the duration of the previous defrost control) of accumulated time have passed since the start of the operation, or ending the previous defrosting

Condition for terminating defrost

The judgment is made with the outdoor heat exchanger temperature ($B^{\circ}C$)

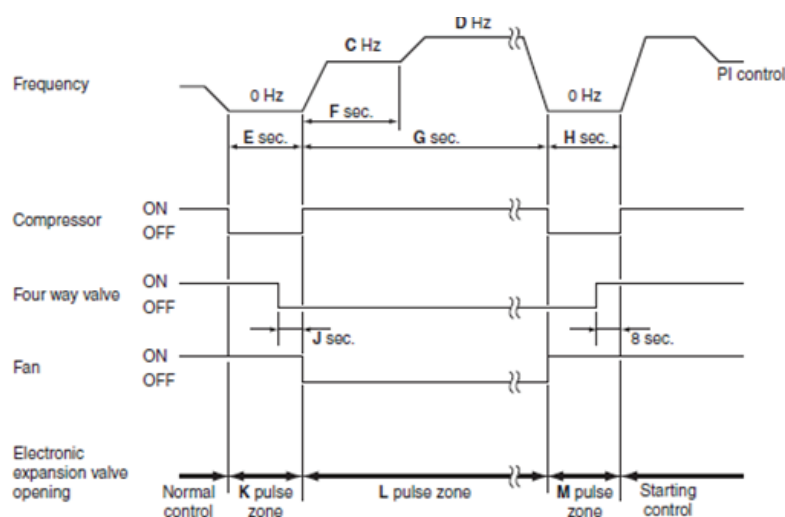

		09 class	12 class	18 class	24 class
A (minute)		20 - 25	20 - 25	25	25
B	(°C)	2 - 20	2 - 20	6 - 30	6 - 30
	(°F)	35.6 – 68.0	35.6 – 68.0	42.8 – 86.0	42.8 – 86.0
C (Hz)		64	64	48	48
D (Hz)		64	64	42	42
E (seconds)		40	40	60	60
F (seconds)		60	60	60	60
G (seconds)		630	630	490	490
H (seconds)		40	50	60	90
J (seconds)		8	8	5	5
K (pulse)		400	400	450	450
L (pulse)		300	300	300 – 450	300 – 450
M (pulse)		200	350	200	200

2.20 Indoor Coil Freeze Prevention

Only available in cooling mode.

When the indoor coil temperature < 2°C (35.6°F), the compressor starts to drop the frequency.

This protection will cut in when:

- Indoor coil temperature < 0°C (32°F) for more than 180s. Compressor will stop, outdoor fan stop after 30s and indoor fan can only run at lowest fan speed.

The unit can only be restarted after 3 minutes.

When the indoor coil temperature > 13°C (55.4°F), the compressor frequency will be reset based on the outdoor ambient, room and set temperature.

2.21 High Pressure Protection

To prevent high pressure in the system.

Compressor operating frequency is adjusted based on upper limit of coil temperature.

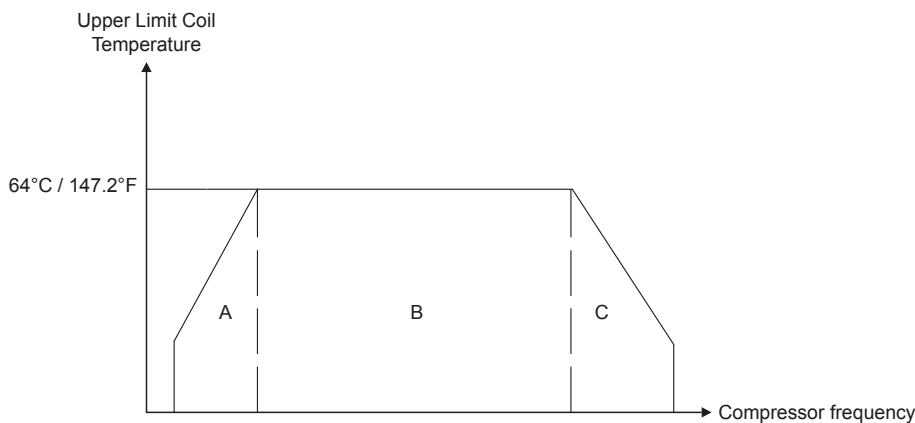

The compressor frequency is adjusted based on coil temperature:

- During cooling mode : outdoor coil temperature.
- During heating mode : indoor coil temperature.

This protection is activated when the coil temperature > 64°C (147.2°F), the compressor stops and outdoor fan stops after 30s. The unit can only be restarted after 3 minutes.

2.22 Discharge Pipe Temperature Control

Used as a measure of the compressor’s internal temperature.

Compressor frequency is control to keep this temperature from going up further when it rises above a certain level.

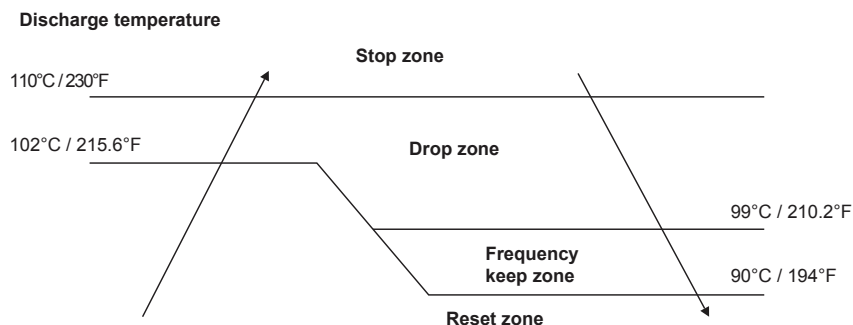

If compressor discharge temperature > 102°C (215.6°F) for the first time, this control starts and sets the current frequency as upper limit. At the same time, running frequency starts to reduce by 1 step and so on, until temperature falls between 99°C (210.2°F) and 90°C (194°F) at the keep zone.

This protection is activated when the compressor discharge temperature > 110°C (230°F). The compressor will stop and considered trip.

If the compressor discharge temperature < 90°C (194°F) , the compressor frequency will be reset based on the outdoor ambient, set and room temperature.

More detail information (i.e. “based on ambient” give the temperatures)

2.23 Overall Current Control

To monitor the overall current and to restrict the compressor upper limit rotation in order to prevent circuit breakers from exceeding the rated capacity.

Detected during compressor running.

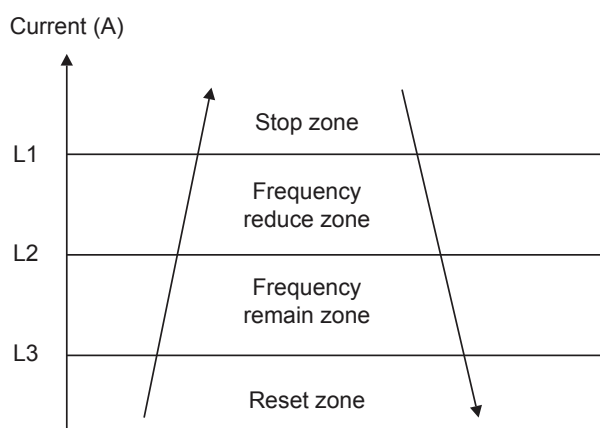

Model	L1
RK(X)B09AX RK(X)N09AX	9.5A
RK(X)B012AX RK(X)N012AX	10.0A
RK(X)B18/24AX RK(X)N18/24AX	16.0A

When the input current for running compressor exceeds L2, the running frequency will be reduced by 1 step. If the current still exceeds L2, frequency will be reduced by another step until total current falls between L2 and L3.

This protection cuts in when the input current exceeds L1 for 2 seconds. Compressor will stop and it is considered total current overload.

If input current < L3, the compressor frequency is reset based on the outdoor ambient, set and room temperature.

2.24 Overall Frequency Control

The compressor frequency is determined according to the difference between the room thermistor temperature and the target temperature.

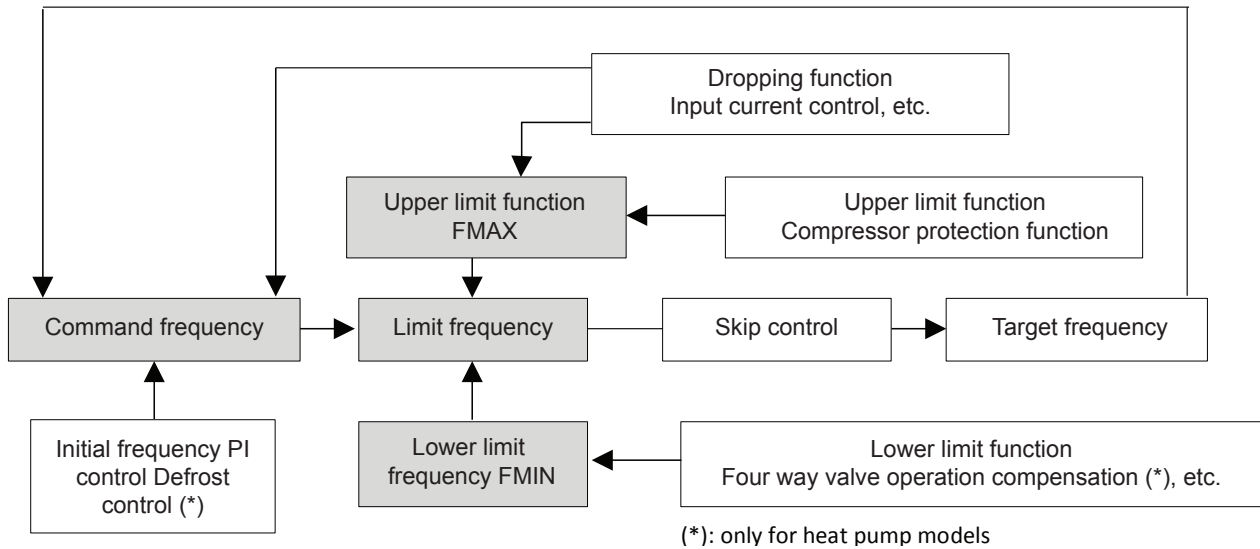

For Cooling Only Model

1. Determine command frequency

Command frequency is determined in the following order of priority.

- a. Forced cooling
- b. Indoor frequency command

2. Determine upper limit frequency

The minimum value is set as an upper limit frequency among the frequency upper limits of the following functions Compressor protection, input current, discharge pipe temperature, freeze-up protection.

3. Determine lower limit frequency

The maximum value is set as a lower limit frequency among the frequency lower limits of the following function:

Pressure difference upkeep.

4. Determine prohibited frequency

There is a certain prohibited frequency such as a power supply frequency.

For Heat Pump Model

1. Determine command frequency

Command frequency is determined in the following order of priority.

- a. Limited defrost control time
- b. Forced cooling
- c. Indoor frequency command

2. Determine upper limit frequency

The minimum value is set as an upper limit frequency among the frequency upper limits of the following functions:

Compressor protection, input current, discharge pipe temperature, heating peak-cut, freeze-up protection, defrost control.

3. Determine lower limit frequency

The maximum value is set as a lower limit frequency among the frequency lower limits of the following functions:

Four way valve operation compensation, draft prevention, pressure difference upkeep.

4. Determine prohibited frequency

There is a certain prohibited frequency such as a power supply frequency.

2.24.1 Initial Frequency

When starting the compressor, the frequency is initialized according to the ΔD value of the indoor unit.

< ΔD signal: Indoor frequency commands>

The difference between the room thermistor temperature and the target temperature is recognized as the ΔD signal and is used for frequency command.

Temperature difference	ΔD signal	Temperature difference	ΔD signal	Temperature difference	ΔD signal	Temperature difference	ΔD signal
-2.0°C (-3.6°F)	*OFF	0°C (0°F)	4	2.0°C (3.6°F)	8	4.0°C (7.2°F)	C
-1.5°C (-2.7°F)	1	0.5°C (0.9°F)	5	2.5°C (4.5°F)	9	4.5°C (8.1°F)	D
-1.0°C (-1.8°F)	2	1.0°C (1.8°F)	6	3.0°C (5.4°F)	A	5.0°C (9.0°F)	E
-0.5°C (-0.9°F)	3	1.5°C (2.7°F)	7	3.5°C (6.3°F)	B	5.5°C (9.9°F)	F

*OFF = Thermostat OFF

2.24.2 PI Control

1. P control

The ΔD value is calculated in each sampling time (20 seconds), and the frequency is adjusted according to its difference from the frequency previously calculated.

2. I control

If the operating frequency does not change for more than a certain fixed time, the frequency is adjusted according to ΔD value.

When the ΔD value is low, the frequency is lowered.

When the ΔD value is high, the frequency is increased.

3. Frequency control when other controls are functioning

- When frequency is dropping;

Frequency control is carried out only when the frequency drops.

- For limiting lower limit;

Frequency control is carried out only when the frequency rises.

4. Upper and lower limit of frequency by PI control

The frequency upper and lower limits are set according to the command of the indoor unit. When the indoor or outdoor unit quiet operation command comes from the indoor unit, the upper limit frequency is lower than the usual setting.

<Cooling / Dry>

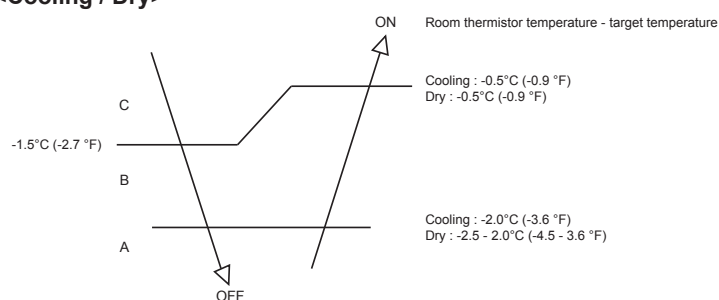

<Heating>

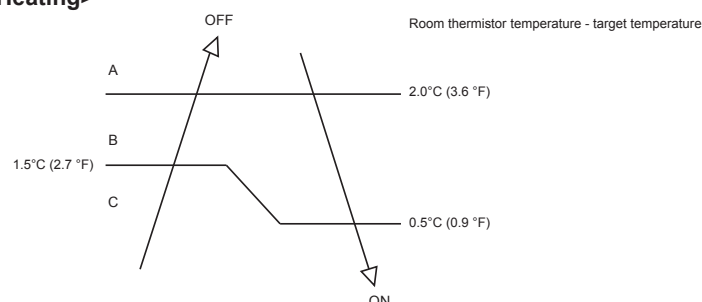

3.0 Service Diagnosis

3.1 Error Indication from Indoor

3.1.1 Indoor model

FTK(X)N09/12/18/24AX

- LED display will either be ON during operation or blinking (blue color) when any error occur as in below table.
- The blinking pattern does not indicate error details
- The error details needs to be retrieved from remote controller in error code form.

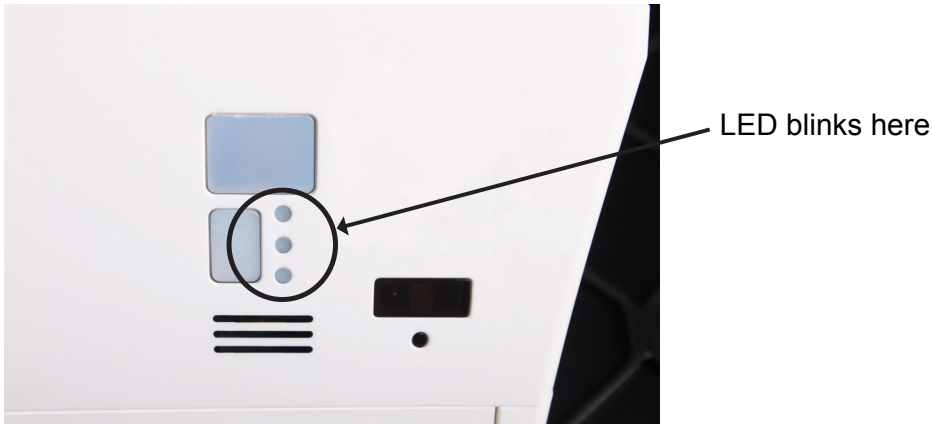



★ SLEEP (ORANGE)	⏻ COOL/HEAT (BLUE/RED)	🕒 TIMER (WHITE)	Operation / Fault Indication
	○ Blue		Cooling mode
	○ Red		Heating mode
	○ Red		Auto mode in heating operation
	○ Blue		Auto mode in cooling operation
		○	Timer On
○	○		Sleep mode on
	○ Blue		Fan mode on
	○ Blue		Dry mode on
	◐ Red		Defrost operation
	◐ Blue		Unit error

○ ON ◐ Blinking

3.1.2 Indoor model FTK(X)B09/12/18/24AX

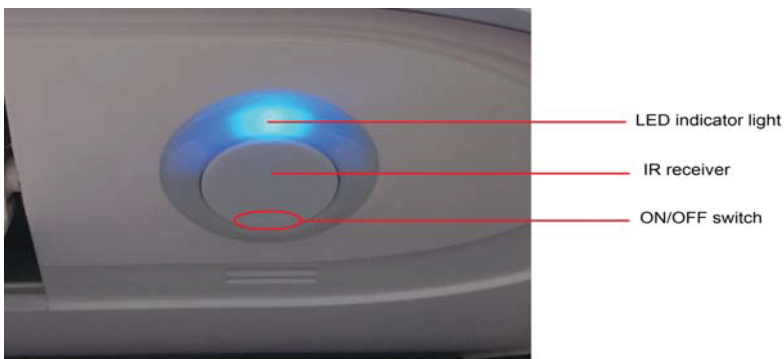
- LED display will either change color under different running condition or blinking (blue color) when any error occur as in below table.
- The blinking pattern does not indicate error details.
- The error details needs to be retrieved from remote controller in error code form.



 COOL/HEAT/TIMER (BLUE/RED/VIOLET)	Operation / Fault Indication
○ Blue	Cooling mode
○ Red	Heating mode
○ Red	Auto mode in heating operation
○ Blue	Auto mode in cooling operation
○ Violet	Timer On
○ Blue	Fan mode on
○ Blue	Dry mode on
◐ Red	Defrost operation
◐ Blue	Error indication

○ ON ◐ Blinking

3.2 Error Code retrieved by remote controller

3.2.1 Remote controller model BRC52A & BRC52B

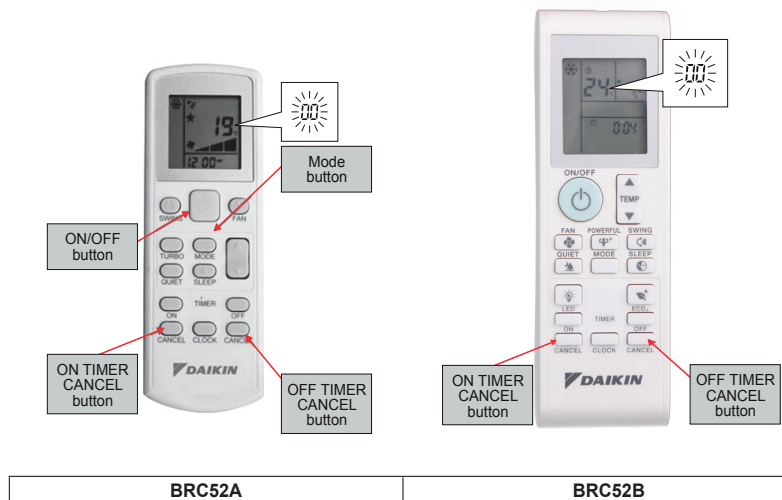

Operating Guide

1. Hold down ON TIMER CANCEL or OFF TIMER CANCEL for 5 seconds until “00” indication flashes on the remote controller temperature display section.
2. Then, press the same button repeatedly. A series of error code will appear until indoor buzzer produces a long beep. The corresponding error code is indicated on the remote controller temperature display section.

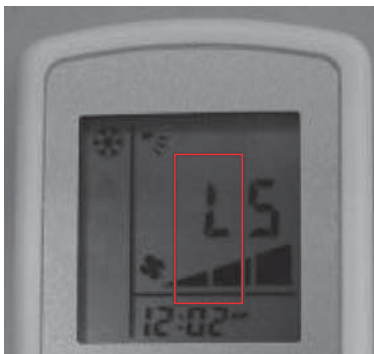

3. Indoor unit buzzer will produce a long beep if the remote controller error code matched with unit error.
4. A short and two consecutive beeps is not the unit error. For two consecutive beeps, it indicates either the alphabet or number is correct.
5. The code display will cancel itself if the button is not pressed for 1 minute.

Last State Error retrieved by remote controller BRC52A & BRC52B

Operating Guide

1. Remove battery from remote controller.
2. Replace battery again into remote controller.
3. Press Mode & ON/OFF buttons together.
4. The “00” will show at temperature section.
5. Press Mode button to 5:00.
6. Press Power On toward the indoor unit. Unit LED blinks two times indicate received signal.
7. ON hold fan button till screen become normal display.
8. Repeat the normal step to retrieve error. (by using remote controller step. Holding TIMER CANCEL...)
9. By using this method, the error shown will be Last State Error. (Previous error in the unit)

3.3 Error code description for Inverter

No.	ERROR CODE	ERROR DESCRIPTION	RK(X)B09/12/18/24AX RK(X)N09/12/18/24AX
1	00	NORMAL	○
2	A1	INDOOR PCB ABNORMALITY	○
3	A5	ANTIFREEZE PROTECTION OR HIGH PRESSURE CONTROL	○
4	A6	INDOOR FAN MOTOR ABNORMALITY	○
5	C4	INDOOR HEAT EXCHANGER THERMISTOR ABNORMALITY	○
6	C9	INDOOR ROOM THERMISTOR ABNORMALITY	○
7	E1	OUTDOOR PCB ABNORMALITY	○
8	E5	COMPRESSOR OVERLOAD	○
9	E6	COMPRESSOR LOCK/START-UP ABNORMALITY	○
10	E7	OUTDOOR FAN MOTOR LOCK	○
11	E8	AC INPUT OVER CURRENT	○
12	EA	4 WAY VALVE ABNORMALITY	○
13	F3	DISCHARGE PIPE OVERHEAT	○
14	F6	HEAT EXCHANGER OVERHEAT	○
15	H0	COMPRESSOR SENSOR SYSTEM ABNORMAL	○
16	H6	POSITION SENSOR ABNORMAL (COMPRESSOR)	○
17	H8	AC CURRENT SENSOR ABNORMALITY	○
18	H9	OUTDOOR AIR THERMISTOR ABNORMALITY	○
19	J3	COMPRESSOR DISCHARGE PIPE THERMISTOR ABNORMALITY	○
20	J6	OUTDOOR HEAT EXCHANGER THERMISTOR ABNORMALITY	○
21	L3	ELECTRICAL BOX TEMPERATURE RISE (COMPRESSOR OFF)	○
22	L4	HEAT SINK OVERHEAT (COMPRESSOR ON)	○
23	L5	IPM ABNORMALITY	○
24	P4	HEAT SINK THERMISTOR ABNORMALITY	○
25	U0	INSUFFICIENT GAS	○
26	U2	DC VOLTAGE OUT OF RANGE	○
27	U4	COMMUNICATION ABNORMALITY	○
28	UA	INSTALLATION ABNORMALITY	○

Remark: ○ : Function
- : Not Applicable

A1	
Description	INDOOR PCB ABNORMALITY
Possible Root cause	1. Faulty indoor PCB. 2. Faulty connector connection at indoor.
Troubleshooting	<pre> graph TD A[Turn off unit.] --> B[Check indoor PCB connector conditions (including PCB to terminal block and all PCB wire connector).] B --> C{Any sign of loose or abnormal.} C -- Yes --> D[Connect correctly and operate again.] C -- No --> E[Replace indoor PCB and operate again.] </pre>

A5	
Description	ANTIFREEZE PROTECTION OR HIGH PRESSURE CONTROL
Possible Root cause	<ol style="list-style-type: none"> 1. Indoor air filter, heat exchanger block due to dust accumulation. 2. Indoor air short circuit. 3. Indoor coil thermistor faulty. 4. Indoor PCB faulty. 5. Fan blower dirty.
Troubleshooting	<pre> graph TD A[Check indoor air flow.] --> B{Any air short circuit?} B -- Yes --> C(Provide sufficient air passage.) B -- No --> D[Check intake air filter.] D --> E{Is it very dirty?} E -- Yes --> F(Clean the air filter.) E -- No --> G[Check the dust accumulate indoor coil.] G --> H{Is it very dirty?} H -- Yes --> I(Clean the indoor coil.) H -- No --> J[Check fan blower condition.] J --> K{Is it very dirty?} K -- Yes --> L(Clean fan blower.) K -- No --> M[Check indoor coil thermistor resistance.] M --- N[# Refer to thermistor resistance table.(Page 67, 6.1)] M --> O{Does it conform to the thermistor resistance table?} O -- Yes --> P(Change indoor PCB.) O -- No --> Q(Change indoor thermistor.) </pre>

A6	
Description	INDOOR FAN MOTOR ABNORMALITY
Possible Root cause	1. Indoor fan motor winding short, or the motor lead wire broken. 2. Indoor PCB faulty.
Troubleshooting	<pre> graph TD Start([Turn off power supply and rotate fan by hand.]) --> D1{Does it rotate?} D1 -- No --> E1([Change fan motor.]) D1 -- Yes --> R1[Check fan motor connector condition.] R1 --> D2{Does it connect properly?} D2 -- No --> E2([Connect correctly.]) D2 -- Yes --> R2[Change PCB and turn on power.] R2 --> E3([Change fan motor.]) </pre>

C4	
Description	INDOOR HEAT EXCHANGER THERMISTOR ABNORMALITY
Possible Root cause	1. Thermistor, connector faulty. 2. Indoor PCB faulty.
Troubleshooting	<pre> graph TD Start[Check the thermistor connector condition.] --> D1{Normal?} D1 -- No --> E1([Correct the connection]) D1 -- Yes --> R1[Check thermistor resistance value.] R1 --> D2{Normal?} D2 -- No --> E2([Replace thermistor]) D2 -- Yes --> E3([Replace PCB.]) </pre> <p># Refer thermistor resistance table.(Page 67, item 6.1)</p> <p>*Remark: Refer Thermistor resistance check procedure in Appendix A.(Page 67, item 6.1)</p>

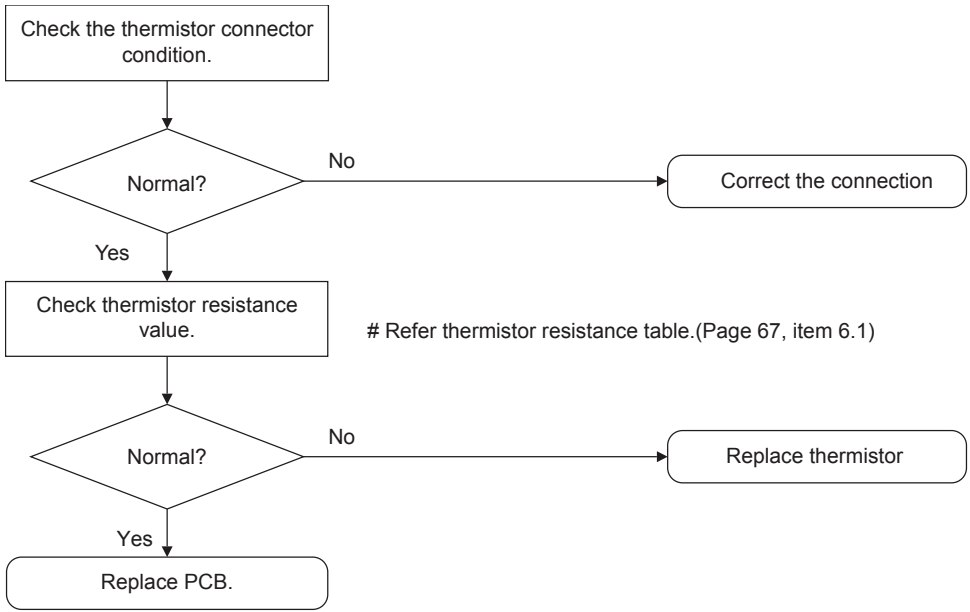
C9	
Description	INDOOR ROOM THERMISTOR ABNORMALITY
Possible Root cause	1. Thermistor, connector faulty. 2. Indoor PCB faulty.
Troubleshooting	 <pre>graph TD; A[Check the thermistor connector condition.] --> B{Normal?}; B -- No --> C[Correct the connection]; B -- Yes --> D[Check thermistor resistance value.]; D --- E[# Refer thermistor resistance table.(Page 67, item 6.1)]; D --> F{Normal?}; F -- No --> G[Replace thermistor]; F -- Yes --> H[Replace PCB.];</pre>

E1	
Description	OUTDOOR PCB ABNORMALITY
Possible Root cause	<ol style="list-style-type: none"> 1. Micro Controller program run-away due to external factor such as Noise, Momentary voltage drop, Momentary power failure. 2. Damage of EEPROM. 3. Faulty outdoor unit PCB. 4. Broken hardness between PCB.
Troubleshooting	<pre> graph TD Start([Turn on the power again.]) --> D1{Error still occur?} D1 -- No --> R1([Replace outdoor PCB.]) D1 -- Yes --> S1[Check if the outdoor unit is grounded.] S1 --> D2{Grounded?} D2 -- No --> R2([Ground the system.]) D2 -- Yes --> D3{Is the harness broken?} D3 -- No --> R3([Replace outdoor PCB.]) D3 -- Yes --> R4([Replace the harness.]) </pre>

E5	
Description	COMPRESSOR OVERLOAD
Possible Root cause	<ol style="list-style-type: none"> 1. Refrigerant Shortage. 2. 4 way valve malfunction. 3. Stop valve malfunction. 4. Outdoor unit PCB defective. 5. Water mixed in refrigerant. 6. Electronic expansion valve defective. 7. Disconnection of discharge pipe thermistor. 8. Faulty discharge pipe thermistor. 9. Disconnection of connector S40. 10. Electronic expansion valve or coil malfunction. 11. Disconnection of 2 terminals of OL.
Troubleshooting	<pre> graph TD D1{Discharge pipe thermistor disconnected?} -- Yes --> A1[Insert thermistor in position.] D1 -- No --> D2{Thermistor resistance normal?} D2 -- No --> A2[Replace thermistor.] D2 -- Yes --> T1[# Refer to thermistor resistance table.(Page 67, item 6.1)] T1 --> D3{Connectors properly connected?} D3 -- No --> A3[Connect back the connectors.] D3 -- Yes --> B1[Disconnect connector S40 from PCB.] B1 --> B2[Check resistance of 2 terminals connector S40.] B2 --> D4{0Ω?} D4 -- Yes --> B3[Check electronic expansion.] B3 --> D5{Malfunction?} D5 -- Yes --> A4[Replace electronic expansion or the coil.] D5 -- No --> B4[Check four way valve.] B4 --> D6{Malfunction?} D6 -- Yes --> A5[Replace four way valve or the coil. Replace outdoor PCB.] D6 -- No --> B5[Check refrigerant line.] B5 --> D7{Malfunction?} D7 -- Yes --> A6[Refer refrigerant line check procedures.] D7 -- No --> A7[Replace outdoor PCB.] D4 -- No --> B6[Disconnect 2 terminals of OL.] B6 --> D8{Resistance between 2 terminals is 0Ω?} D8 -- No --> A8[Disconnect 2 terminals of OL.] D8 -- Yes --> A9[Disconnect 2 terminals of OL.] </pre> <p>*Remark: Please refer to Appendix A for Electronic expansion valve (page 69,item 6.2), four way valve (page 69,item 6.3) and refrigerant line checking procedures (page 70,item 6.4).</p>

E5	
Description	COMPRESSOR OVERLOAD
Possible Root cause	1. Refrigerant Shortage. 2. 4 way valve malfunction. 3. Electronic expansion valve defective. 4. Outdoor unit PCB defective. 5. Water mixed in refrigerant.
Troubleshooting	<pre> graph TD Start([Turn off unit. Disconnect compressor wire hardness (U.V.W) and check winding.]) --> D1{Resistance follow spec?} D1 -- No --> C1([Change compressor.]) D1 -- Yes --> S1[Connect back wire and turn on unit.] S1 --> D2{Compressor stop without running?} D2 -- Yes --> C2([Change outdoor PCB.]) D2 -- No --> S2[Check electronic expansion. #Refer page 69 item 6.2] S2 --> D3{Malfunction?} D3 -- Yes --> C3([Replace electronic expansion or the coil.]) D3 -- No --> S3[Check four way valve. #Refer page 69 item 6.3] S3 --> D4{Malfunction?} D4 -- Yes --> C4([Replace four way valve or the coil. Replace outdoor PCB.]) D4 -- No --> S4[Check refrigerant line. #Refer page 70 item 6.4] S4 --> D5{Malfunction?} D5 -- Yes --> C5([Refer refrigerant line check procedures.]) D5 -- No --> C6([Replace outdoor PCB.]) </pre>

E6	
Description	COMPRESSOR LOCK/START-UP ABNORMALITY
Possible Root cause	1. Compressor locked. 2. Compressor harness disconnect.
Troubleshooting	<pre> graph TD A[Turn off power. Disconnect harnesses U, V and W.] --> B[Check with Inverter analyzer.] B --> C{Normal?} C -- No --> D[Correct power supply or replace outdoor unit PCB.] C -- Yes --> E[Turn off power and reconnect harnesses. Turn on power again and restart system.] E --> F{Emergency stop without compressor running?} F -- Yes --> G[Replace the compressor.] F -- No --> H{System shut down after errors repeated several times?} H -- No --> I[Check outdoor electronic expansion valve coil. Replace it as required.] H -- Yes --> J[Replace the compressor.] </pre>

E7	
Description	OUTDOOR FAN MOTOR LOCK
Possible Root cause	1. Fan motor breakdown. 2. Harness or connector disconnected between fan motor and PCB or in poor contact. 3. Foreign matter stuck in fan. 4. Defective outdoor unit PCB.
Troubleshooting	<pre> graph TD Q1{Fan motor connector disconnected?} -- Yes --> A1(Turn off power and reconnect connector.) Q1 -- No --> Q2{Foreign matters in or around fan?} Q2 -- Yes --> A2(Remove foreign matters.) Q2 -- No --> P1(Turn on the power.) P1 --> P2(Rotate the fan.) P2 --> Q3{Fan rotates smoothly?} Q3 -- No --> A3(Replace outdoor fan motor.) Q3 -- Yes --> P3(Check rotation pulse input on outdoor unit PCB.) P3 --> Q4{Pulse signal generated?} Q4 -- No --> A4(Replace outdoor fan motor.) Q4 -- Yes --> A5(Replace outdoor PCB.) </pre> <p>*Remark: Refer Appendix A for rotation pulse check.(Page 71, item 6.5)</p>

E8	
Description	AC INPUT OVER CURRENT
Possible Root cause	<ol style="list-style-type: none"> 1. Over current due to compressor failure. 2. Over current due to defective outdoor unit PCB. 3. Over current due to defective power transistor. 4. Over current due to short-circuit.
Troubleshooting	<pre> graph TD A[Measure the input current.] --> B{Input current flowing above its stop level?} B -- No --> C(Replace the outdoor unit.) B -- Yes --> D[Check outdoor fan motor, outdoor ambient temperature, refrigerant charge level] D --> E{Any abnormal?} E -- Yes --> F(Refer to the type of abnormality and conduct proper service.) E -- No --> G(Turn off the power and disconnect the harness U, V and W.) G --> H[Check with the inverter checker.] H --> I{Compressor faulty?} I -- Yes --> J(Change Compressor.) I -- No --> K(Change outdoor Control Box.) </pre>

EA	
Description	4 WAY VALVE ABNORMALITY
Possible Root cause	1. Thermistor defective. 2. 4 way valve defective. 3. Outdoor PCB defective. 4. Insufficient gas. 5. Foreign substance mixed in refrigerant. 6. Stop valve defective. 7. Disconnect of 4 way valve coil.
Troubleshooting	<pre> graph TD Q1{Four way valve coil disconnected (loose)?} -- Yes --> A1[Correct the four way valve coil.] Q1 -- No --> Q2{Harness disconnected?} Q2 -- Yes --> A2[Reconnect the harness.] Q2 -- No --> B1[Check the continuity of the four way valve coil and harness.] B1 --> B2[Disconnect the harness from the connector.] B2 --> Q3{Resistance between harnesses within spec?} Q3 -- No --> A3[Replace the four way valve coil. Class 09/12: 1000 ~ 2000 Ω Class 18/24: 560 Ω +- 56 Ω] Q3 -- Yes --> Q4{Check the four way valve switching output.} Q4 -- Malfunction --> A4[Replace the outdoor unit PCB.] Q4 -- Functioning --> Q5{Any thermistor disconnected?} Q5 -- Yes --> A5[Reconnect the thermistor(s).] Q5 -- No --> Q6{Check the thermistors.} Q6 -- Malfunction --> A6[Replace the defective thermistor(s).] Q6 -- Functioning --> Q7{Check the refrigerant line.} Q7 -- Malfunction --> A7[Refer to the refrigerant line check procedure.] Q7 -- Functioning --> A8[Replace the four way valve (defective or dust-clogged).] </pre> <p>*Remark: Refer to Appendix A for thermistor resistance checking procedures.(Page 67, item 6.1) Refer to Appendix A for Four way valve performance checking procedures.(Page 69, item 6.2) Refer to Appendix A for Inverter unit refrigerant check procedures.(Page 70, item 6.4)</p>

F3	
Description	DISCHARGE PIPE OVERHEAT
Possible Root cause	<ol style="list-style-type: none"> 1. Refrigerant shortage. 2. Four way valve malfunctioning. 3. Discharge pipe thermistor defective. 4. Outdoor PCB defective. 5. Water mixed in the local piping. 6. EXV defective. 7. Stop Valve defective.
Troubleshooting	<div style="text-align: center;"> <pre> graph TD A{Check the thermistors.} -- Malfunction --> B(Replace the defective thermistor(s).) A -- Functioning --> C{Check the electronic expansion valve.} C -- Malfunction --> D(Replace the electronic expansion valve or the coil.) C -- Functioning --> E{Check the refrigerant line.} E -- Malfunction --> F(Refer to the refrigerant line check procedure.) E -- Functioning --> G(Replace the outdoor unit PCB.) </pre> </div> <p>*Remark: Refer to Appendix A for thermistor resistance checking procedures. (Page 67, item 6.1) Refer to Appendix A for Electronic Expansion Valve (EXV) checking procedures. (Page 69, item 6.2) Refer to Appendix A for Inverter unit refrigerant check procedures. (Page 70, item 6.4)</p>

F6	
Description	HEAT EXCHANGER OVERHEAT
Possible Root cause	<ol style="list-style-type: none"> 1. The installation space is not large enough. 2. Faulty outdoor fan motor. 3. Faulty EXV. 4. Faulty outdoor heat exchanger thermistor. 5. Faulty stop valve. 6. Dirty heat exchanger. 7. Unit overcharge. 8. Defective outdoor unit PCB.
Troubleshooting	<pre> graph TD Start([Check the installation space.]) --> D1{Check the installation condition.} D1 -- Malfunction --> A1[Change the installation location or direction. Clean the outdoor heat exchanger.] D1 -- Functioning --> D2{Check the outdoor fan.} D2 -- Malfunction --> A2[Replace the outdoor fan motor. Reconnect the connector or fan motor lead wires.] D2 -- Functioning --> D3{Check the electronic expansion valve.} D3 -- Malfunction --> A3[Replace the electronic expansion valve or the coil. Replace the outdoor unit PCB.] D3 -- Functioning --> D4{Check the outdoor heat exchanger thermistor.} D4 -- Malfunction --> A4[Replace the outdoor heat exchanger thermistor.] D4 -- Functioning --> A5[Replace the outdoor unit PCB.] </pre> <p>*Remark: Refer to Appendix A for thermistor resistance checking procedures. (Page 67, item 6.1) Refer to Appendix A for Electronic Expansion Valve (EXV) checking procedures. (Page 69, item 6.2) Refer to Appendix A for Inverter unit refrigerant check procedures. (Page 70, item 6.4) Refer to Appendix A for Installation condition check. (Page 71, item 6.6)</p>

H0 (Class 18/24)	
Description	COMPRESSOR SENSOR SYSTEM ABNORMAL
Possible Root cause	1. Broken and disconnected harness. 2. Outdoor unit PCB defective. 3. Defective compressor.
Troubleshooting	<pre> graph TD A[Check reactor connection.] --> B{Any abnormal?} B -- Yes --> C[Connect back reactor.] B -- No --> D[Check reactor resistance.] D --- E[# Disconnect the reactor wire and measure resistance between terminal.] D --> F{<10 Ω?} F -- No --> G[Change reactor.] F -- Yes --> H[Check compressor resistance.] H --> I{<10 Ω?} I -- No --> J[Change Compressor.] I -- Yes --> K[Change outdoor PCB.] </pre>

H0 (Class 09/12)	
Description	COMPRESSOR SENSOR SYSTEM ABNORMAL
Possible Root cause	1. Broken and disconnected harness. 2. Outdoor unit PCB defective.
Troubleshooting	<pre> graph TD A[Check the harness S30.] --> B{Is the harness broken?} B -- Yes --> C(Replace the harness.) B -- No --> D[Turn off the power and turn it on again.] D --> E{Get restarted and error displayed again?} E -- No --> F(No problem. Keep on running.) E -- Yes --> G(Replace the PCB.) </pre>

H6 (Class 09/12)	
Description	POSITION SENSOR ABNORMAL (COMPRESSOR)
Possible Root cause	1. Compressor relay cable disconnected. 2. Compressor itself defective. 3. Outdoor PCB defective. 4. Stop valve closed. 5. Input voltage out of specification.
Troubleshooting	<pre> graph TD A[Check for short circuit.] --> B{Normal?} B -- No --> C[Replace the outdoor unit PCB, outdoor unit fan.] B -- Yes --> D[Check the electrolytic capacitor voltage.] D --> E{DC320 ± 30 V?} E -- No --> F[Replace the outdoor unit PCB.] E -- Yes --> G{Electricals or compressor harnesses connected as specified?} G -- No --> H[Reconnect as specified.] G -- Yes --> I[Turn off the power. Disconnect the harness U, V and W.] I --> J[Check with inverter checker (*).] J --> K{Any LED off?} K -- Yes --> L[Correct the power supply or replace the outdoor unit PCB.] K -- No --> M[Replace the compressor.] </pre> <p>* Inverter checker Part No.: 1225477</p>

H6 (Class 18/24)	
Description	POSITION SENSOR ABNORMAL (COMPRESSOR)
Possible Root cause	1. Compressor relay cable disconnected. 2. Compressor itself defective. 3. Outdoor PCB defective. 4. Stop valve closed. 5. Input voltage out of specification
Troubleshooting	<pre> graph TD A[Turn off the power.] --> B[Check the power supply voltage.] B --> C{Voltage as rated?} C -- No --> D[Correct the power supply.] C -- Yes --> E[Check stop valve.] E --> F{OK?} F -- No --> G[Replace the stop valve.] F -- Yes --> H[Check the short circuit of the diode bridge.] H --> I{Normal?} I -- No --> J[Replace the outdoor unit PCB.] I -- Yes --> K[Check the connection.] K --> L{Electrical components or compressor harnesses connected as specified?} L -- No --> M[Reconnect the electrical components or compressor harnesses as specified.] L -- Yes --> N[Turn on the power. Check the electrolytic capacitor voltage.] N --> O{320 = 50 VDC?} O -- No --> P[Replace the outdoor unit PCB.] O -- Yes --> Q[Turn off the power. Disconnect the harnesses U, V and W.] Q --> R[Check with the inverter analyzer. * Inverter analyzer: RSUK0917C] R --> S{Any LED off?} S -- No --> T[Replace the compressor.] S -- Yes --> U[Correct the power supply or replace the outdoor unit PCB.] </pre> <p>Remark: Refer to Appendix A for Diode bridge short circuit check procedures. (Page 72, item 6.8)</p>

H8	
Description	AC CURRENT SENSOR ABNORMALITY
Possible Root cause	1. Internal wiring broken. 2. Outdoor unit PCB defective.
Troubleshooting	<div style="text-align: center;"> <pre> graph TD A[Check compressor harness connection.] --> B{Connection correct?} B -- No --> C(Reconnect it correctly.) B -- Yes --> D[Restart the system and check connector between main board and IPM board.] D --> E{Does it connect properly?} E -- No --> F(Reconnect it properly.) E -- Yes --> G(Change outdoor PCB.) </pre> </div> <p>*Remark: This error is only applicable for model Class 18/24.</p>

H9, J3, J6, P4	
Description	Thermistor or related abnormality H9: OUTDOOR AIR THERMISTOR ABNORMALITY J3: COMPRESSOR DISCHARGE PIPE THERMISTOR ABNORMALITY J6: OUTDOOR HEAT EXCHANGER THERMISTOR ABNORMALITY P4: HEAT SINK THERMISTOR ABNORMALITY
Possible Root cause	1. Disconnection of the connector for the thermistor. 2. Thermistor corresponding to the error code is defective. 3. Defective heat exchanger thermistor in the case of J3 error (outdoor heat exchanger thermistor in cooling operation, or indoor heat exchanger thermistor in heating operation). 4. Defective outdoor unit PCB.
Troubleshooting	<div style="text-align: center;"> <pre> graph TD Start([Turn on the power again.]) --> D1{Error displayed again on remote controller?} D1 -- No --> R1(Reconnect the connectors or thermistors.) D1 -- Yes --> S1[Check the thermistor resistance value.] S1 --> D2{Normal?} D2 -- No --> R2(Replace the defective thermistor(s) of the following thermistors. * Outdoor temperature thermistor. * Discharge pipe thermistor. * Outdoor heat exchanger thermistor.) D2 -- Yes --> S2[Check the indoor heat exchanger thermistor resistance value in the heating operation.] S2 --> D3{Indoor heat exchanger thermistor functioning?} D3 -- No --> R3(Replace the indoor heat exchanger thermistor.) D3 -- Yes --> R4(Replace the outdoor unit PCB.) </pre> </div> <p style="margin-top: 20px;"> *Remark: Refer to Appendix A for thermistor resistance check procedures. (Page 67, item 6.1) </p>

L3							
Description	ELECTRICAL BOX TEMPERATURE RISE (COMPRESSOR OFF)						
Possible Root cause	1. Fin temperature rise due to defective outdoor unit fan. 2. Fin temperature rise due to short circuit. 3. Fin thermistor defective. 4. Connector in poor contact. 5. Outdoor unit PCB defective.						
Troubleshooting	<div style="text-align: center;"> <pre> graph TD Start([Turn off the unit and turn on back after 20 mins.]) --> Error{Error again?} Error -- No --> Fan[Check outdoor fan.] Error -- Yes --> Thermistor[Check heat sink thermistor resistance.] Fan --> FanFunc{Outdoor fan functioning?} FanFunc -- No --> FanMotor([Change outdoor fan motor.]) FanFunc -- Yes --> HeatSinkDirty{Heat sink dirty?} HeatSinkDirty -- No --> Install[Check installation condition.] HeatSinkDirty -- Yes --> CleanSink([Clean the heat sink.]) Thermistor --> ResNormal{Resistance normal?} ResNormal -- No --> ChangeThermistor([Change thermistor.]) ResNormal -- Yes --> TempHigh{Heat sink temperature > A°C?} TempHigh -- No --> ChangePCB([Change outdoor PCB.]) TempHigh -- Yes --> ChangeSink([Change heat sink or check outdoor fan condition.]) </pre> </div> <table border="1" style="width: 100%; border-collapse: collapse;"> <thead> <tr> <th style="text-align: center;">Models</th> <th style="text-align: center;">A °C (°F)</th> </tr> </thead> <tbody> <tr> <td>Class 09/12</td> <td style="text-align: center;">78 (172.4)</td> </tr> <tr> <td>class 18/24</td> <td style="text-align: center;">122 (251.6)</td> </tr> </tbody> </table> <p>*Remark: Refer to Appendix A for thermistor resistance check procedures. (Page 67, item 6.1) Refer to Appendix A for outdoor fan system check. (Page 72, item 6.7) Refer to Appendix A for installation condition check. (Page 71, item 6.6)</p>	Models	A °C (°F)	Class 09/12	78 (172.4)	class 18/24	122 (251.6)
Models	A °C (°F)						
Class 09/12	78 (172.4)						
class 18/24	122 (251.6)						

L4							
Description	Heat sink overheat						
Possible Root cause	<ol style="list-style-type: none"> 1. Fin temperature rise due to short circuit. 2. Fin temperature rise due to defective outdoor unit fan. 3. Fin thermistor defective. 4. Connector in poor contact. 5. Outdoor unit PCB defective. 6. Silicon grease is not applied properly on the radiation fin after replacing outdoor unit PCB. 						
Troubleshooting	<div style="text-align: center;"> <p>Turn off the power and turn it on again to start the system.</p> <pre> graph TD Start[Turn off the power and turn it on again to start the system.] --> D1{Error displayed again?} D1 -- No --> D2{Check the outdoor fan.} D1 -- Yes --> D3{Has the PCB been replaced?} D3 -- Yes --> A1[Check if silicon grease is applied properly on the radiation fin. If not, apply the silicon grease.] D3 -- No --> B1[Check the radiation fin temperature.] B1 --> D4{Above A °C?} D4 -- No --> A2[Replace the outdoor unit PCB.] D4 -- Yes --> D2 D2 -- Malfunction --> A3[Replace the outdoor fan motor. Correct the connectors and fan motor leads. Replace the outdoor unit PCB.] D2 -- Functioning --> D5{Radiation fin dirty?} D5 -- No --> A4[Check the installation condition.] D5 -- Yes --> A5[Clean up the radiation fin.] </pre> </div> <table border="1" style="width: 100%; border-collapse: collapse;"> <thead> <tr> <th style="text-align: center;">Models</th> <th style="text-align: center;">A °C (°F)</th> </tr> </thead> <tbody> <tr> <td>Class 09/12</td> <td style="text-align: center;">93 (199.4)</td> </tr> <tr> <td>class 18/24</td> <td style="text-align: center;">85 (185)</td> </tr> </tbody> </table> <p>*Remark: Refer to Appendix A for outdoor fan system check. (Page 72, item 6.7) Refer to Appendix A for installation condition check. (Page 71, item 6.6)</p>	Models	A °C (°F)	Class 09/12	93 (199.4)	class 18/24	85 (185)
Models	A °C (°F)						
Class 09/12	93 (199.4)						
class 18/24	85 (185)						

L5	
Description	IPM ABNORMALITY
Possible Root cause	<ol style="list-style-type: none"> 1. Over current due to defective power transistor. 2. Over current due to wrong internal wiring. 3. Over current due to abnormal supply voltage. 4. Over current due to defective PCB. 5. Error detection due to defective PCB. 6. Over- current due to closed stop valve. 7. Over current due to compressor failure. 8. Over current due to poor installation condition. 9. Connection between main board and IPM board is not properly connect.
Troubleshooting	<pre> graph TD Start([Check the installation condition.]) --> D1{Stop valve fully open?} D1 -- No --> A1([Fully open the stop valve.]) D1 -- Yes --> P1[Turn off the power and turn it on again to start the system. See if the same error occurs.] P1 --> D2{Error again?} D2 -- No --> A2([Monitor the power supply voltage and suction pressures, and other factors for a long term.]) D2 -- Yes --> P2[Turn off power and disconnect the harnesses U, V and W.] P2 --> P3[Check with the inverter analyzer.] P3 --> D3{Any LED off?} D3 -- Yes --> A3([Correct the power supply or replace the outdoor unit PCB.]) D3 -- No --> P4[Turn off the power and reconnect the harnesses. Turn on the power again and start operation.] P4 --> P5[Check the power supply voltage.] P5 --> D4{Voltage as rated?} D4 -- No --> A4([Correct the power supply.]) D4 -- Yes --> A5([Replace the compressor.]) </pre> <p>*Remark: Refer to Appendix A for installation condition check. (Page 71, item 6.6)</p>

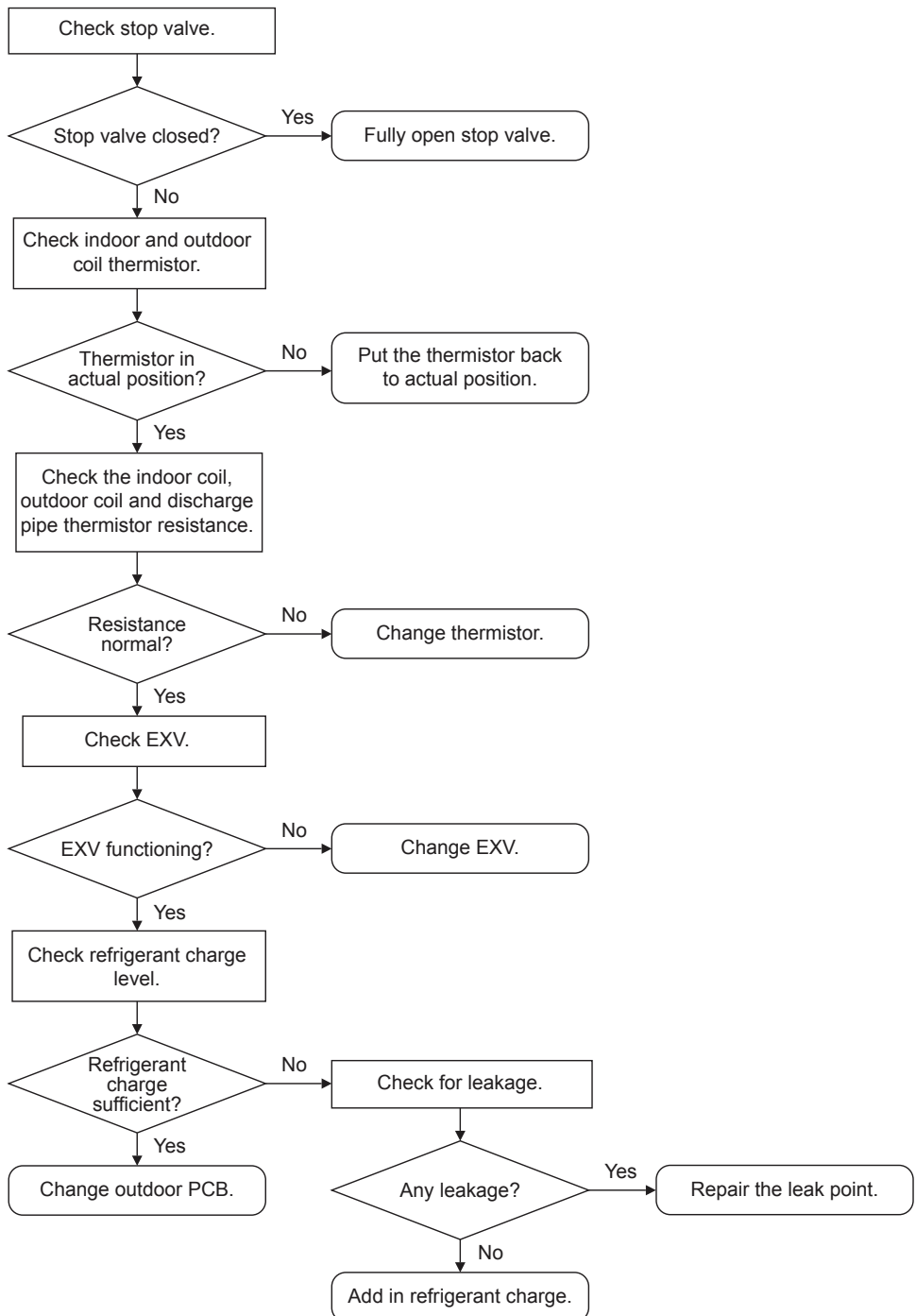
U0	
Description	INSUFFICIENT GAS
Possible Root cause	<ol style="list-style-type: none"> 1. Disconnection of the discharge pipe thermistor, indoor or outdoor heat exchanger, room or outdoor temperature thermistor. 2. Closed stop valve. 3. Refrigerant shortage (refrigerant leakage). 4. Poor compression performance of compressor. 5. Defective electronic expansion valve.
Troubleshooting	 <pre> graph TD A[Check stop valve.] --> B{Stop valve closed?} B -- Yes --> C(Fully open stop valve.) B -- No --> D[Check indoor and outdoor coil thermistor.] D --> E{Thermistor in actual position?} E -- No --> F(Put the thermistor back to actual position.) E -- Yes --> G[Check the indoor coil, outdoor coil and discharge pipe thermistor resistance.] G --> H{Resistance normal?} H -- No --> I(Change thermistor.) H -- Yes --> J[Check EXV.] J --> K{EXV functioning?} K -- No --> L(Change EXV.) K -- Yes --> M[Check refrigerant charge level.] M --> N{Refrigerant charge sufficient?} N -- Yes --> O(Change outdoor PCB.) N -- No --> P[Check for leakage.] P --> Q{Any leakage?} Q -- Yes --> R(Repair the leak point.) Q -- No --> S(Add in refrigerant charge.) </pre> <p>*Remark: Refer to Appendix A for thermistor resistance checking procedures. (Page 67, item 6.1) Refer to Appendix A for electronic expansion device checking procedures. (Page 69, item 6.2)</p>

U2	
Description	DC VOLTAGE OUT OF RANGE
Possible Root cause	<ol style="list-style-type: none"> 1. Power supply voltage is not as specified. 2. Defective DC voltage detection circuit. 3. Defective over-voltage detection circuit. 4. Defective PAM control part. 5. Disconnection of compressor harness 6. Short circuit inside the fan motor winding. 7. Noise. 8. Momentary drop of voltage. 9. Momentary power failure. 10. Defective outdoor unit PCB.
Troubleshooting	<pre> graph TD A[Check the power supply voltage.] --> B{Is the voltage fluctuation within ±10% from the rated value?} B -- No --> C[Correct the power supply.] B -- Yes --> D[Check the connection of the compressor harness.] D --> E{Loose or disconnected?} E -- Yes --> F[Reconnect the harness.] E -- No --> G{Does the outdoor fan rotate smoothly?} G -- No --> H[Replace the outdoor fan motor and the outdoor unit PCB.] G -- Yes --> I[Turn on the power.] I --- J["(Precaution before turning on the power again.) Make sure the power has been off for at least 30 seconds."] J --> K{System restarted? (Repeat a few times.)} K -- No --> L[Replace the outdoor unit PCB.] K -- Yes --> M["Disturbance factors * Noise * Power supply distortion"] M --> N[Check for such factors for a long term.] </pre>

U4	
Description	COMMUNICATION ABNORMALITY
Possible Root cause	1. Faulty outdoor unit PCB. 2. Faulty indoor unit PCB. 3. Indoor unit – outdoor unit signal transmission error due to wiring error. 4. Indoor unit – outdoor unit signal transmission error due to disturbed power supply waveform. 5. Indoor unit – Outdoor unit signal transmission error due to breaking of wire in the connection wires between the indoor and outdoor units
Troubleshooting	<pre> graph TD A[Check the power supply voltage.] --> B{Is the voltage fluctuation within ±10% from the rated value?} B -- No --> C[Correct the power supply.] B -- Yes --> D[Check the indoor unit - outdoor unit connection wires.] D --> E{Is there any wiring error?} E -- Yes --> F[Correct the indoor unit - outdoor unit connection wires.] E -- No --> G[Check the voltage of the connection wires on the indoor terminal board between No. 1(L) and SIG, and between No. 2 (N) and SIG.] G --> H{Properly connected?} H -- Yes --> I[Replace the connection wires between the indoor unit and outdoor unit.] H -- No --> J[Check the LED A on the outdoor unit PCB.] J --> K{Is LED A blinking?} K -- No --> L[Diagnose the outdoor unit PCB.] K -- Yes --> M{Rotate the outdoor fan by hand. Does the outdoor fan rotate smoothly?} M -- No --> N[Replace the outdoor fan motor and the outdoor unit PCB.] M -- Yes --> O[Check the power supply waveform.] O --> P{Is there any disturbance?} P -- No --> Q[Replace the indoor unit PCB.] P -- Yes --> R[Locate the cause of the disturbance of the power supply waveform, and correct it.] </pre> <p>*Remark: Refer to Appendix A for power supply waveform check procedures. (Page 73, item 6.9)</p>

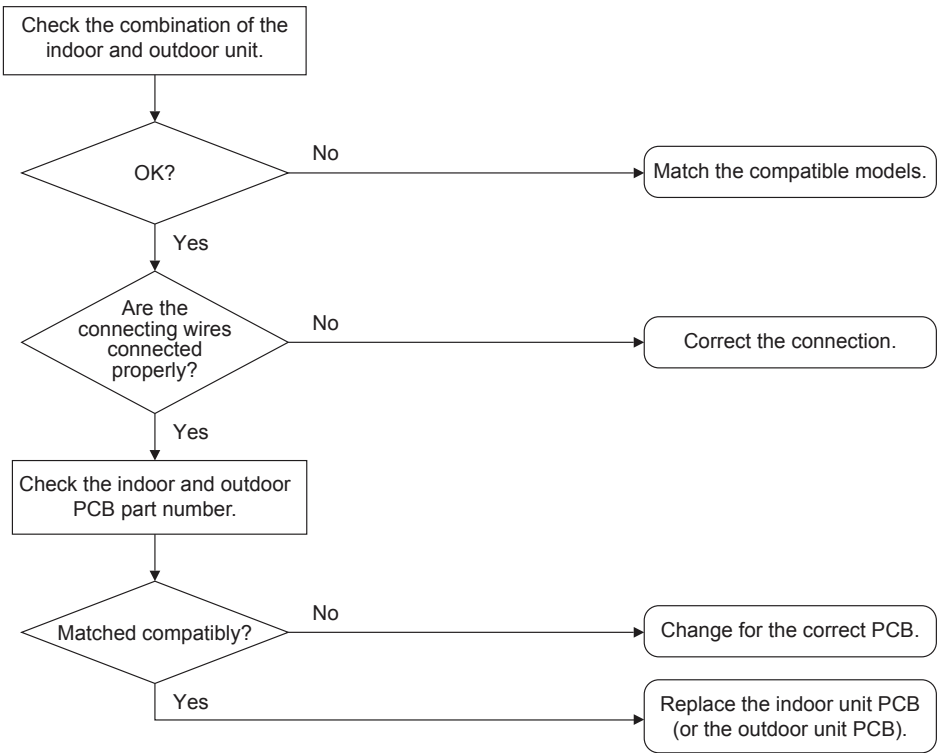
UA	
Description	INSTALLATION ABNORMALITY
Possible Root cause	1. Wrong models interconnected. 2. Wrong indoor unit PCB mounted. 3. Indoor unit PCB defective. 4. Wrong outdoor unit PCB mounted or defective.
Troubleshooting	 <pre> graph TD A[Check the combination of the indoor and outdoor unit.] --> B{OK?} B -- No --> C[Match the compatible models.] B -- Yes --> D{Are the connecting wires connected properly?} D -- No --> E[Correct the connection.] D -- Yes --> F[Check the indoor and outdoor PCB part number.] F --> G{Matched compatibly?} G -- No --> H[Change for the correct PCB.] G -- Yes --> I[Replace the indoor unit PCB (or the outdoor unit PCB).] </pre>

4.0 Wiring Connection

Model: FTKB09/12AX-RKB09/12AX ; FTKN09/12AX-RKN09/12AX

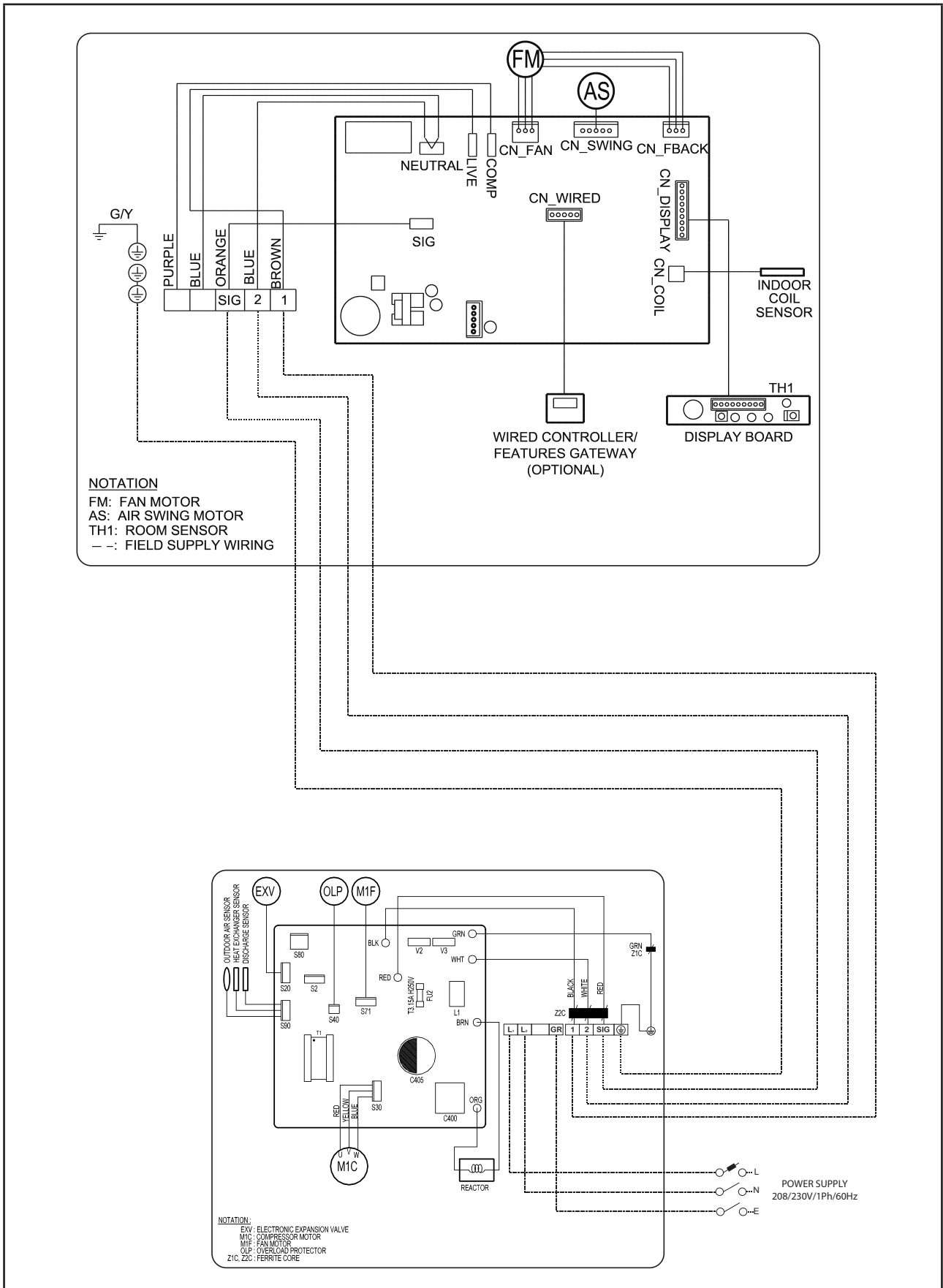

Model: FTKB18/24AX-RKB18/24AX ; FTKN18/24AX-RKN18/24AX

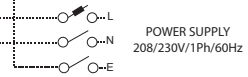
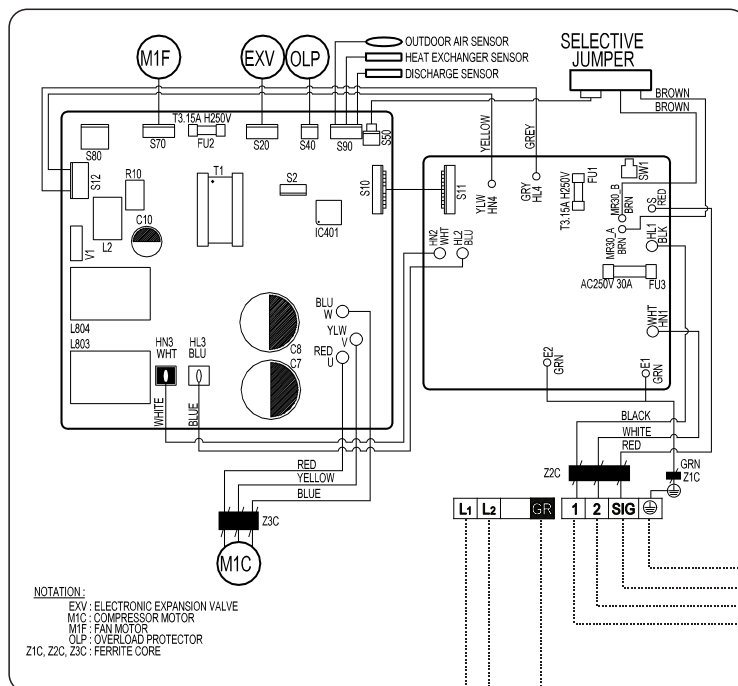
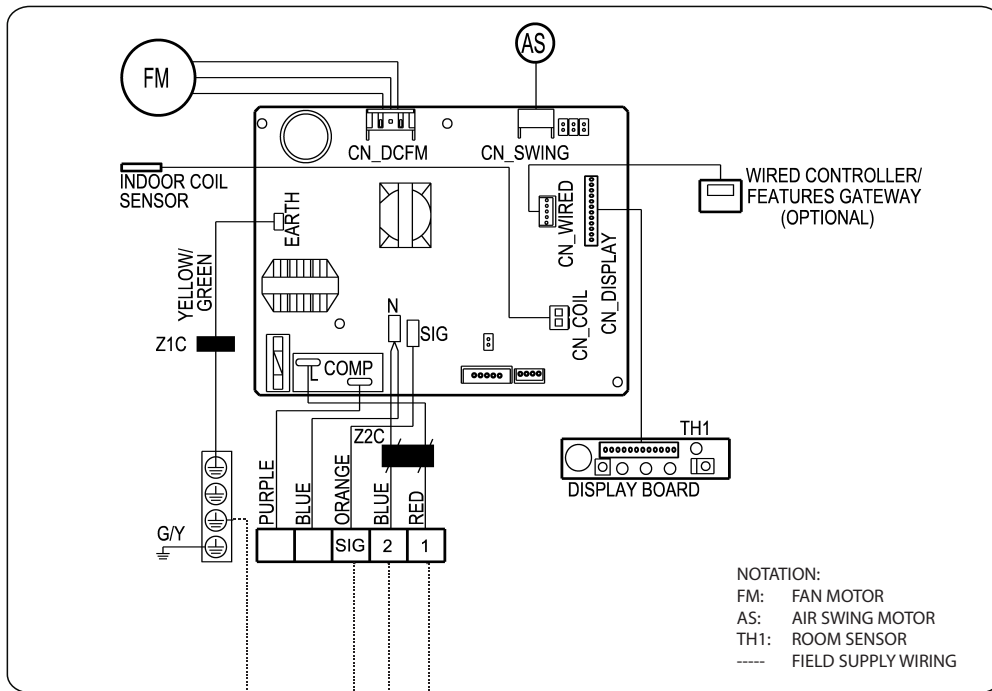

Model: FTXB09/12AX-RXB09/12AX ; FTXN09/12AX-RXN09/12AX

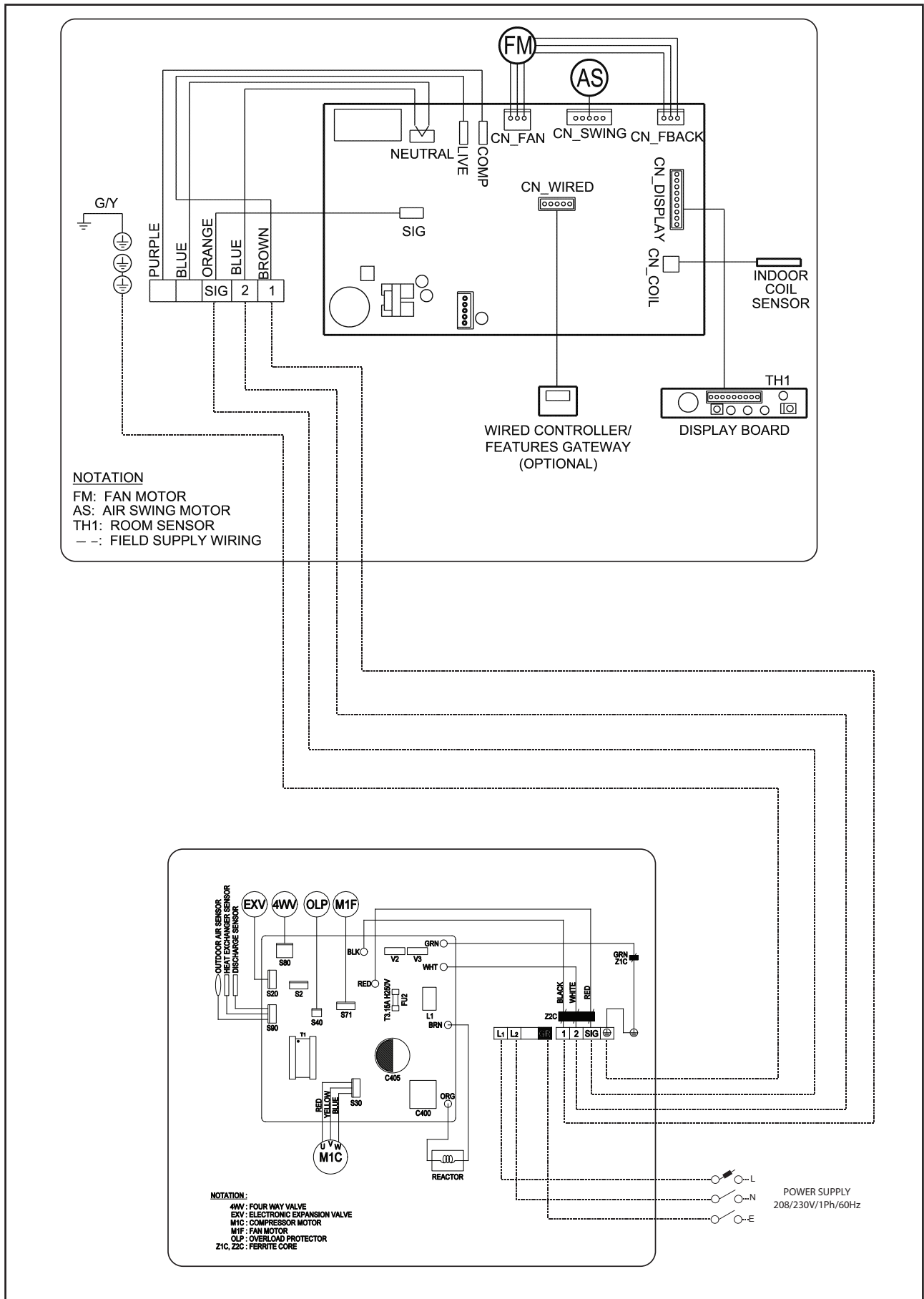

Model: FTXB18/24AX-RXB18/24AX ; FTXN18/24AX-RXN18/24AX

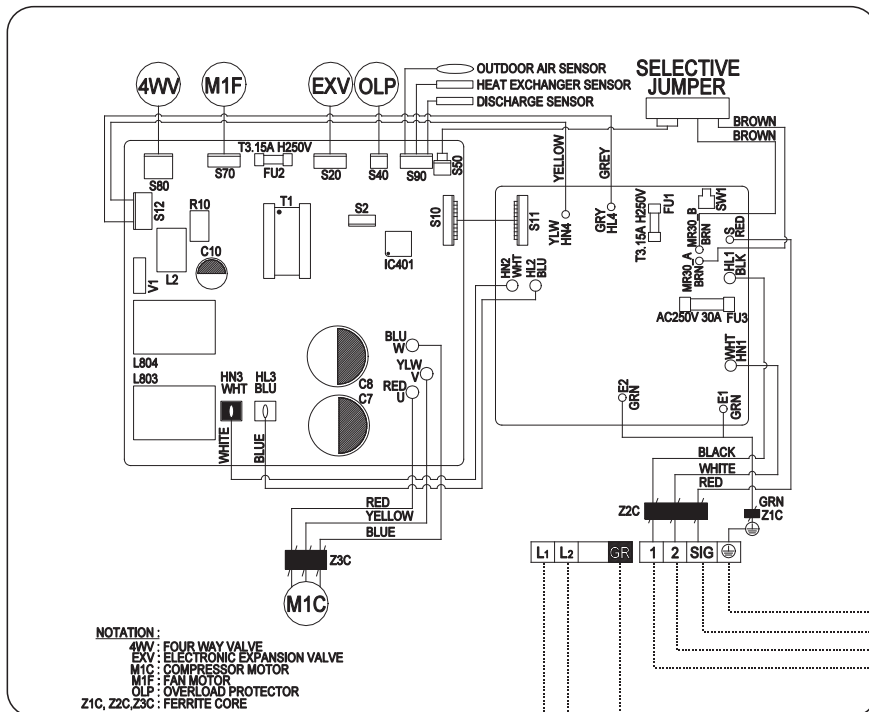
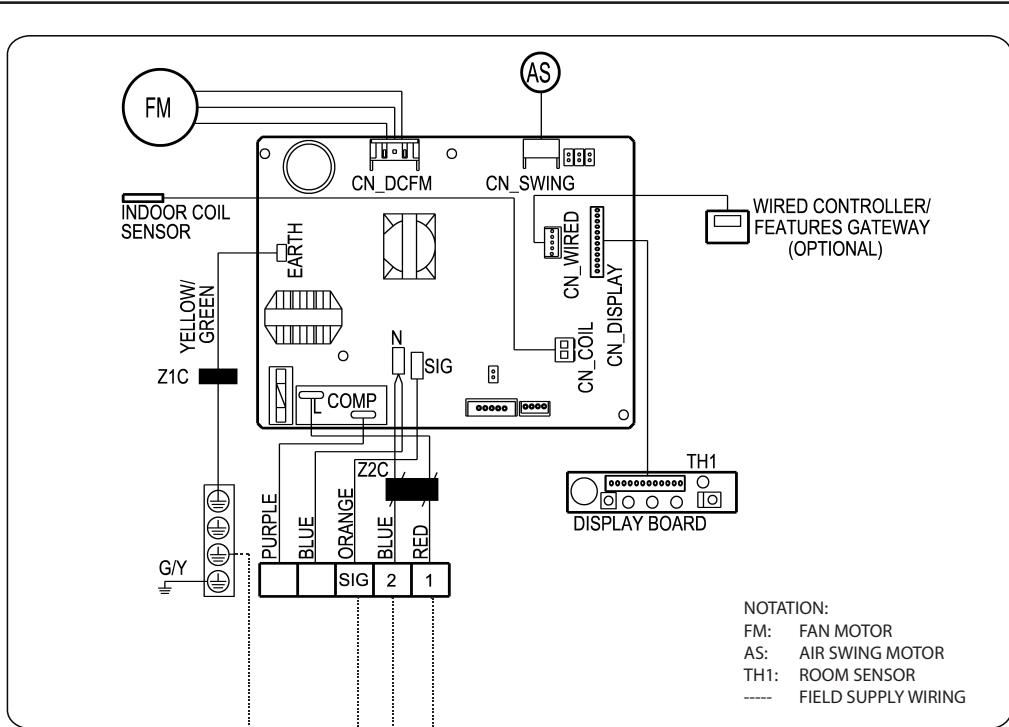

5.0 Refrigerant Diagram

Model: FTKB09/12AX - RKB09/12AX , FTKN09/12AX - RKN09/12AX

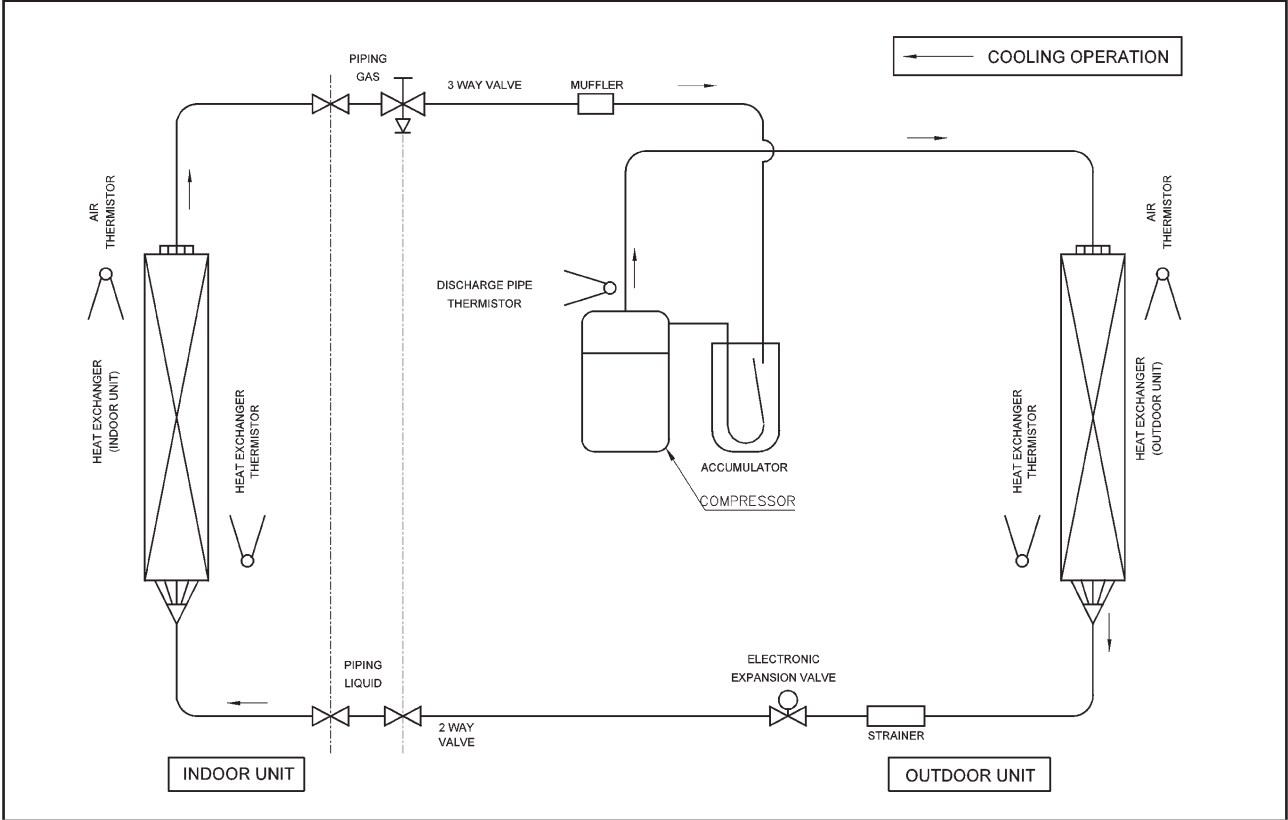

Model: FTKB18/24AX - RKB18/24AX , FTKN18/24AX - RKN18/24AX

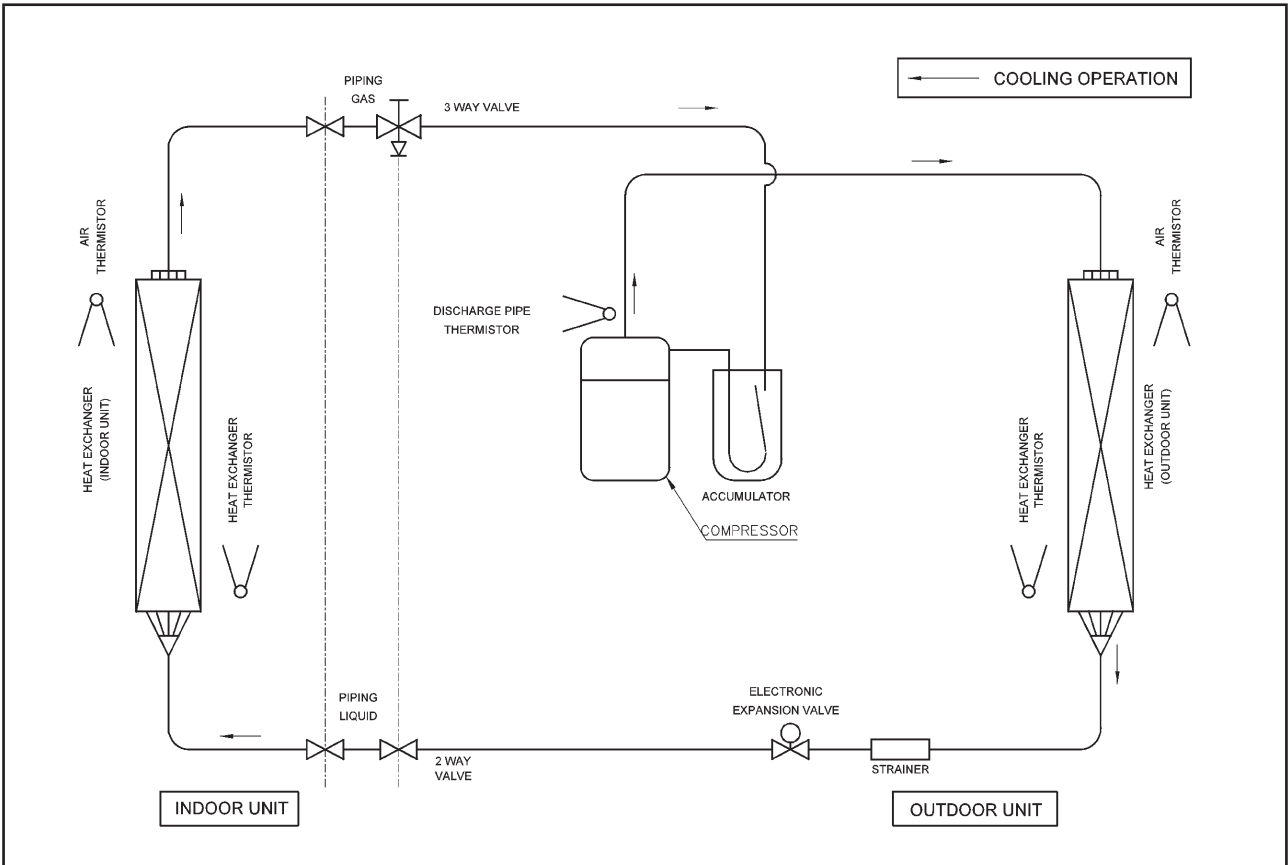

Model: FTXB09/12AX - RXB09/12AX , FTXN09/12AX - RXN09/12AX

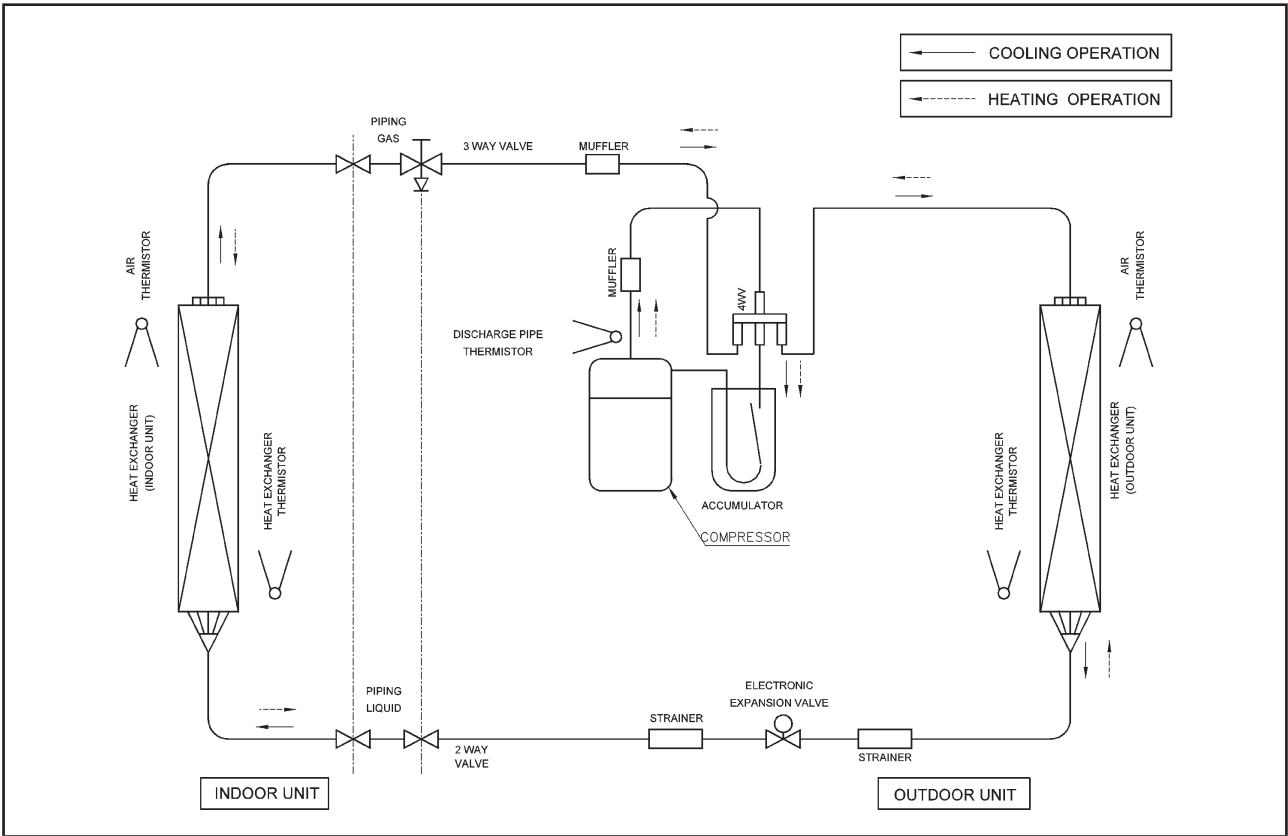

Model: FTXB18/24AX - RXB18/24AX , FTXN18/24AX - RXN18/24AX

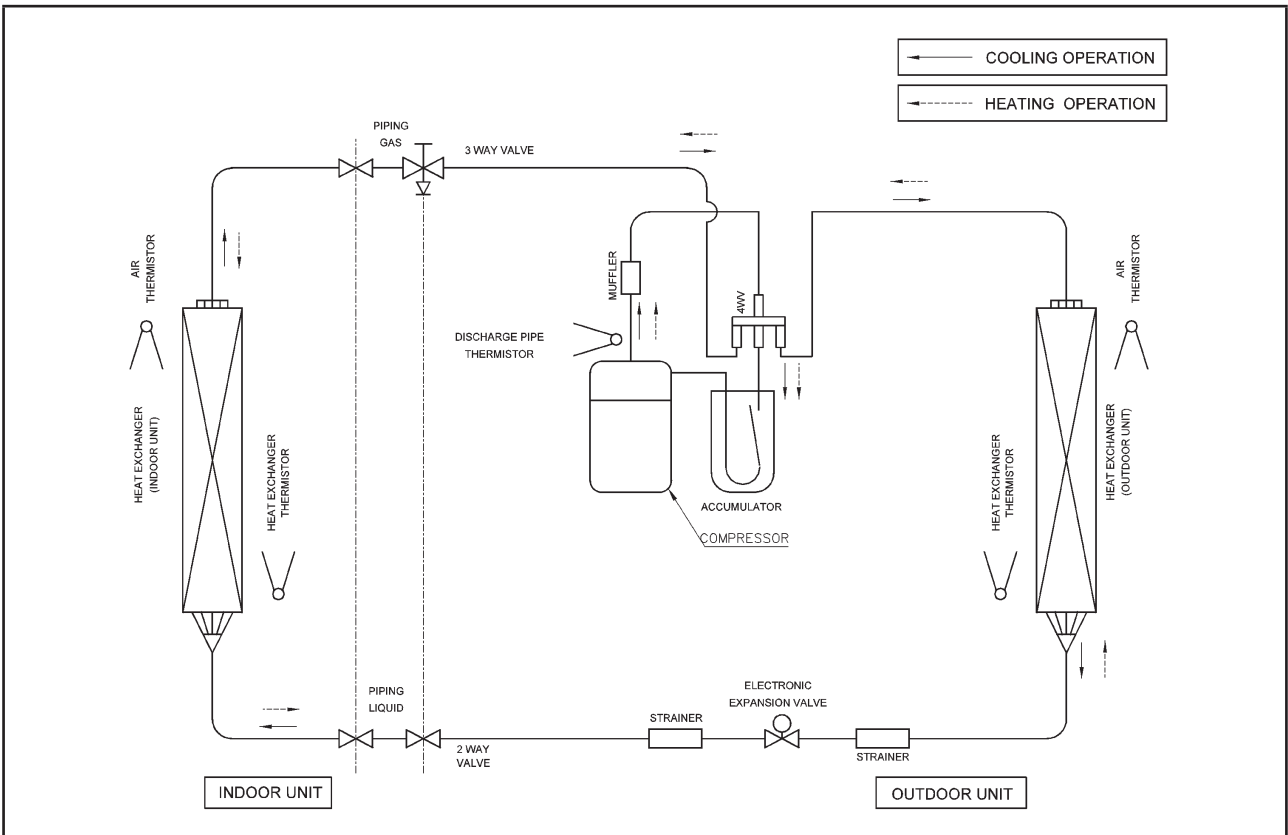

6.0 Appendix A:

6.1 Thermistor resistance checking procedures

Remove the connectors of thermistors at PCB and measure resistance of each thermistor using tester as shown below.

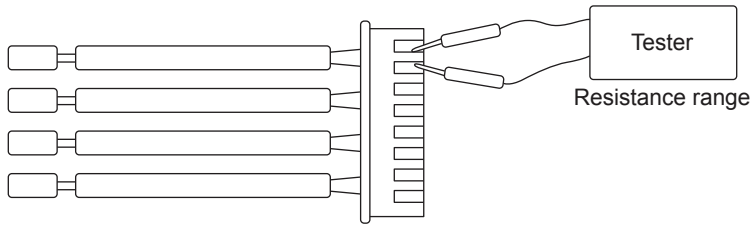

Resistance value refer to Resistance table below.

		Class 09/12/18/24
Indoor	Wall Mounted	10 kΩ (Table 2)
Outdoor	Outdoor Split	10 kΩ (Table 2)

Table 1: Resistance R25 = 20 kΩ

Temperature (°C)	Temperature (°F)	Resistance value (kΩ)
-20	-4	211.0
-15	5	150.0
-10	14	116.5
-5	23	88.0
0	32	67.2
5	41	51.9
10	50	40.0
15	59	31.8
20	68	25.0
25	77	20.0
30	86	16.0
34	95	13.0
40	104	10.6
45	113	8.7
50	122	7.2

Table 2: Resistance R25 = 10 kΩ

t°C	t°F	Rmin (kΩ)	Rnom (kΩ)	Rmax (kΩ)	t°C	t°F	Rmin (kΩ)	Rnom (kΩ)	Rmax (kΩ)
-10	14.0	44.20	45.30	46.50	41	105.8	5.47	5.56	5.64
-9	15.8	42.10	43.20	44.30	42	107.6	5.28	5.37	5.45
-8	17.6	40.20	41.20	42.20	43	109.4	5.10	5.18	5.27
-7	19.4	38.30	39.20	40.20	44	111.2	4.92	5.01	5.09
-6	21.2	36.60	37.40	38.30	45	113.0	4.75	4.84	4.92
-5	23.0	34.90	35.70	36.50	46	114.8	4.59	4.67	4.76
-4	24.8	33.30	34.10	34.90	47	116.6	4.44	4.52	4.60
-3	26.6	31.80	32.60	33.30	48	118.4	4.29	4.37	4.42
-2	28.4	30.40	31.10	31.80	49	120.2	4.15	4.22	4.30
-1	30.2	29.00	29.70	30.30	50	122.0	4.01	4.09	4.16
0	32.0	27.80	28.40	29.00	51	123.8	3.88	3.95	4.03
1	33.8	26.60	27.10	27.70	52	125.6	3.75	3.82	3.90
2	35.6	25.40	25.90	26.50	53	127.4	3.63	3.70	3.77
3	37.4	24.30	24.80	25.30	54	129.2	3.51	3.58	3.65
4	39.2	23.30	23.70	24.20	55	131.0	3.40	3.47	3.54
5	41.0	22.30	22.70	23.10	56	132.8	3.29	3.36	3.43
6	42.8	21.40	21.80	22.10	57	134.6	3.18	3.25	3.32
7	44.6	20.50	20.80	21.20	58	136.4	3.08	3.15	3.22
8	46.4	19.60	20.00	20.30	59	138.2	2.98	3.05	3.12
9	48.2	18.80	19.10	19.40	60	140.0	2.89	2.96	3.01
10	50.0	18.00	18.30	18.60	61	141.8	2.80	2.86	2.93
11	51.8	17.30	17.60	17.80	62	143.6	2.71	2.78	2.84
12	53.6	16.60	16.90	17.10	63	145.4	2.63	2.69	2.75
13	55.4	15.90	16.20	16.40	64	147.2	2.55	2.61	2.67
14	57.2	15.30	15.50	15.70	65	149.0	2.47	2.53	2.59
15	59.0	14.70	14.90	15.10	66	150.8	2.40	2.45	2.51
16	60.8	14.10	14.30	14.50	67	152.6	2.32	2.38	2.44
17	62.6	13.50	13.70	13.90	68	154.4	2.25	2.31	2.37
18	64.4	13.00	13.20	13.30	69	156.2	2.19	2.24	2.30
19	66.2	12.50	12.70	12.80	70	158.0	2.12	2.17	2.23
20	68.0	12.00	12.20	12.30	71	159.8	2.06	2.11	2.17
21	69.8	11.60	11.70	11.80	72	161.6	2.00	2.05	2.10
22	71.6	11.10	11.20	11.40	73	163.4	1.94	1.99	2.04
23	73.4	10.70	10.80	10.90	74	165.2	1.88	1.93	1.98
24	75.2	10.30	10.40	10.50	75	167.0	1.83	1.88	1.93
25	77.0	9.90	10.00	10.10	76	168.8	1.77	1.82	1.87
26	78.8	9.52	9.62	9.72	77	170.6	1.72	1.77	1.82
27	80.6	9.16	9.26	9.36	78	172.4	1.67	1.72	1.77
28	82.4	8.82	8.92	9.02	79	174.2	1.63	1.67	1.72
29	84.2	8.49	8.59	8.69	80	176.0	1.58	1.62	1.67
30	86.0	8.17	8.27	8.37	81	177.8	1.53	1.58	1.62
31	87.8	7.87	7.97	8.07	82	179.6	1.49	1.53	1.58
32	89.6	7.58	7.68	7.78	83	181.4	1.45	1.49	1.54
33	91.4	7.31	7.40	7.50	84	183.2	1.41	1.45	1.49
34	93.2	7.04	7.14	7.23	85	185.0	1.37	1.41	1.45
35	95.0	6.79	6.88	6.98	86	186.8	1.33	1.37	1.41
36	96.8	6.54	6.64	6.73	87	188.6	1.30	1.33	1.38
37	98.6	6.31	6.40	6.50	88	190.4	1.26	1.30	1.34
38	100.4	6.09	6.18	6.27	89	192.2	1.23	1.26	1.30
39	102.2	5.87	5.96	6.05	90	194.0	1.19	1.23	1.27
40	104.0	5.67	5.75	5.84					

Remarks: At ambient temperature of 25°C (77°F), nominal resistance value is 10.00kΩ.

6.2 Electronic Expansion Valve (EXV) checking procedures

- Check if the EXV connector is correctly connected to PCB.
- Turn power off and on again, and check if EXV generates a latching sound.
- If the EXV does not generate a latching sound in above step b., disconnect connector and check continuity using a multimeter.
- Check the continuity between pins [1-6, 3-6, 2-5, 4-5 (between pins 1-6, 2-6, 3-6, 4-6 for harness 5P models)]. If there is no continuity between the pins, EXV coil is faulty.
- If the continuity is confirmed in step d., outdoor PCB is faulty.

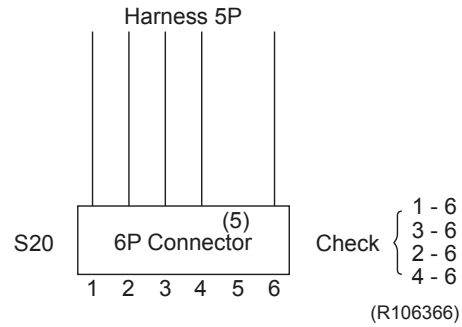
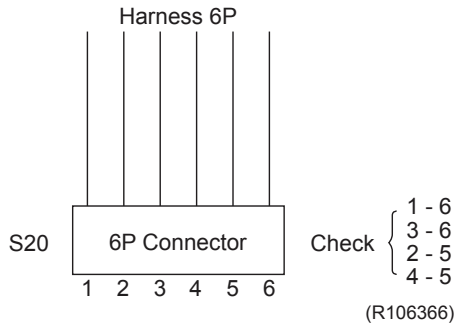

6.3 Four way valve performance checking procedures

6.3.1 Class 09/12

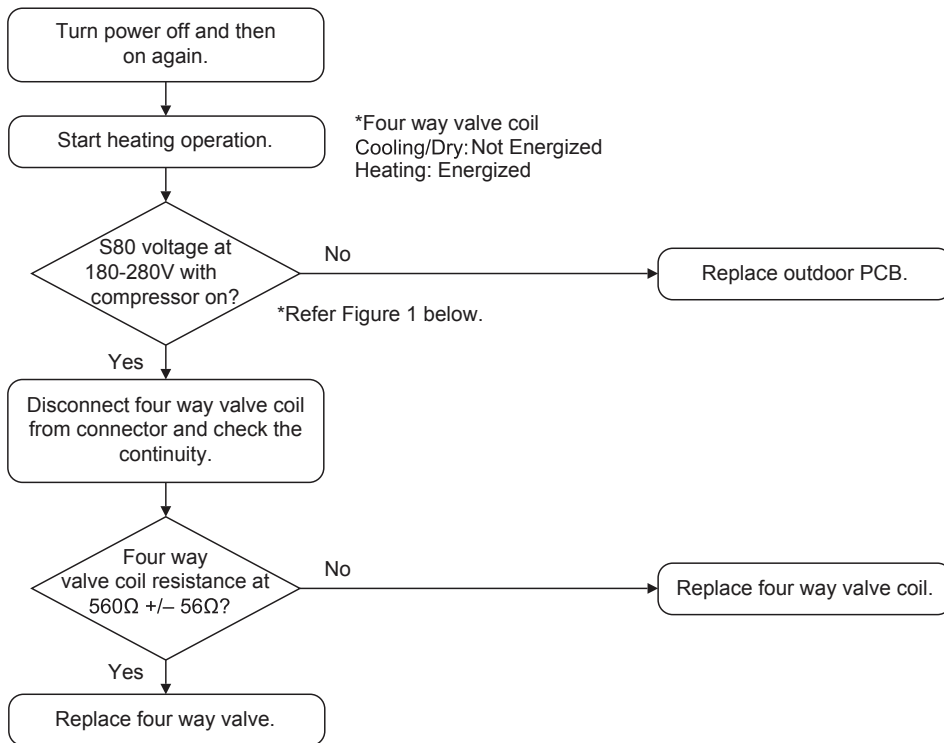

(Fig. 1)

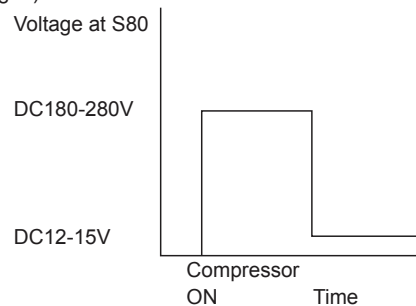

6.3.2 Class 18/24

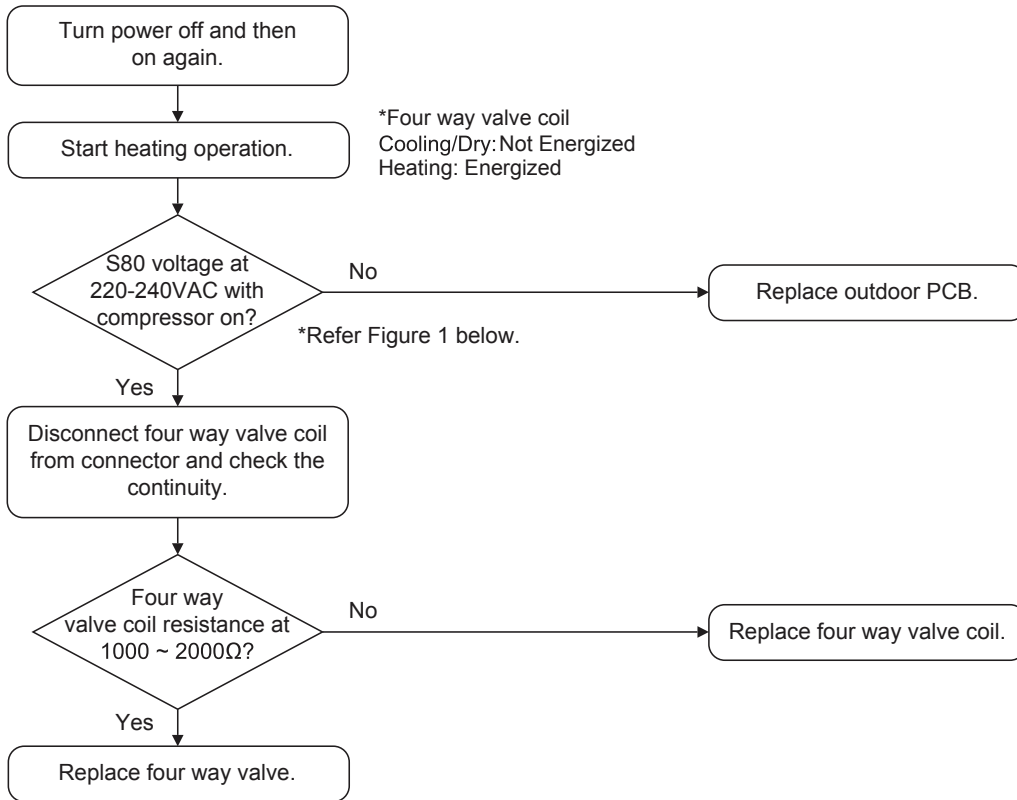

(Fig. 1)

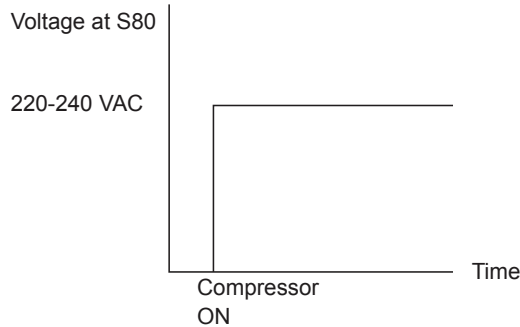

6.4 Inverter unit refrigerant check procedures

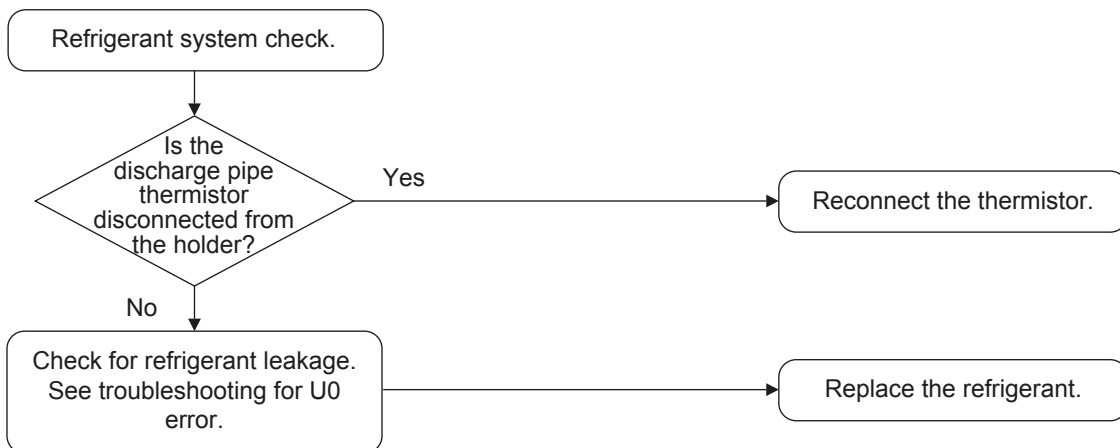

6.5 Rotation pulse check on outdoor unit PCB

Make sure that the voltage of 320 ± 30 V is applied.

1. Set operation off and power off. Disconnect the connector S71.
2. Check that the voltage between the pins 4 & 7 is 320 VDC.
3. Check that the control voltage between the pins 3 & 4 is 15 VDC.
4. Check that the rotation command voltage between the pins 2 & 4 is 0 - 6.5 VDC.
5. Keep operation off and power off. Connect the connector S71.
6. Check whether 4 pulses (0 ~ 15 VDC) are output at the pins 1 - 4 when the fan motor is rotated 1 turn by hand.

When the fuse is melted, check the outdoor fan motor for proper function.

If NG in step 2 : Defective PCB and replace the outdoor unit PCB.

If NG in step 4 : Defective Hall IC and replace the outdoor fan motor.

If OK in both steps 2 and 4,replace the outdoor unit PCB.

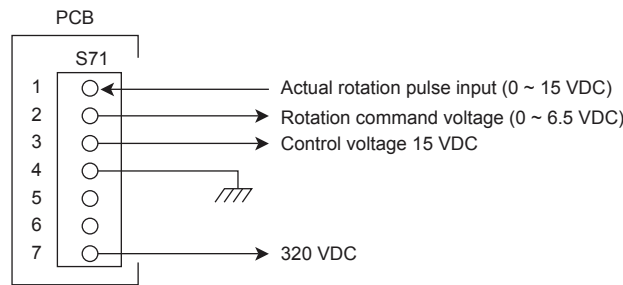

6.6 Installation condition check

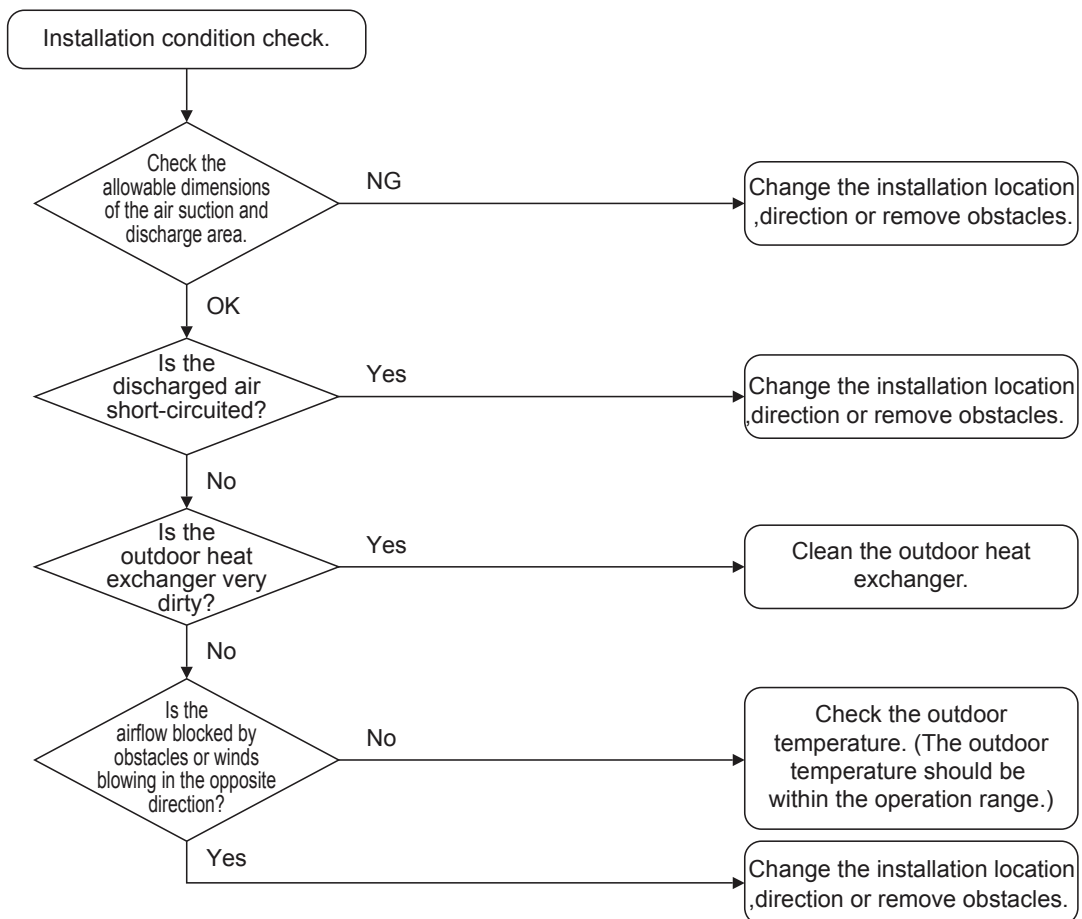

6.7 Outdoor fan system check

DC motor

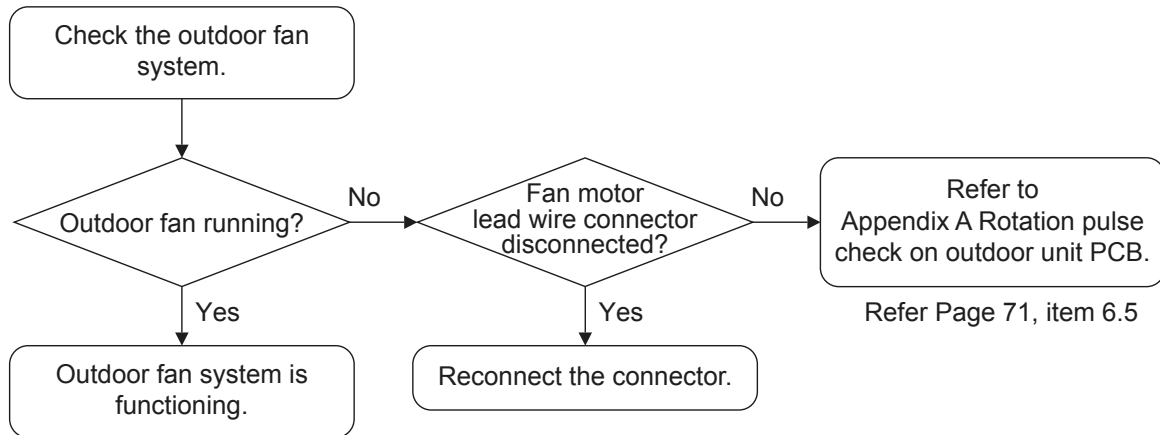

6.8 Diode bridge short circuit check procedures

6.8.1 Power transistor check for class 09 & class 12

Check to make sure that the voltage between the terminal of Power transistor (+) and (-) is approx. 0 volt before checking power transistor.

<Measuring method>

Disconnect the compressor harness connector from the outdoor unit PCB. To disengage the connector, press the protrusion on the connector.

Then, follow the procedure below to measure resistance between power transistor (+) and (-) and the U, V and W terminals of the compressor connector with a multi-tester. Evaluate the measurement results for a pass/fail judgment.

<Power transistor check>

Negative (-) terminal of tester (positive terminal (+) for digital tester)	Power transistor (+)	UVW	Power transistor (-)	UVW
Positive (+) terminal of tester (negative terminal (-) for digital tester)	UVW	Power transistor (+)	UVW	Power transistor (-)
Normal resistance	Several kΩ to several MΩ (*)			
Unacceptable resistance	Short (0Ω) or open			

6.8.2 Main circuit short check for class 18 & class 24

Check to make sure that the voltage between (+) and (-) of the diode bridge (DB1) is approximately 0 V before checking.

- Measure the resistance between the pins of the DB1 referring to the table below.
- If the resistance is ∞ or less than 1 kW, short circuit occurs on the main circuit.

Negative (-) terminal of multimeter	- (2, 3)	+ (4)	- (2, 3)	- (1)
Positive (+) terminal of multimeter	+ (4)	- (2, 3)	- (1)	- (2, 3)
Resistance is OK	Several kΩ ~ several MΩ	∞	∞	Several kΩ ~ several MΩ
Resistance is NG	0Ω or ∞	0	0	0Ω or ∞

*Remark:

1. Use opposite sign of terminal for digital multimeter for measurement.

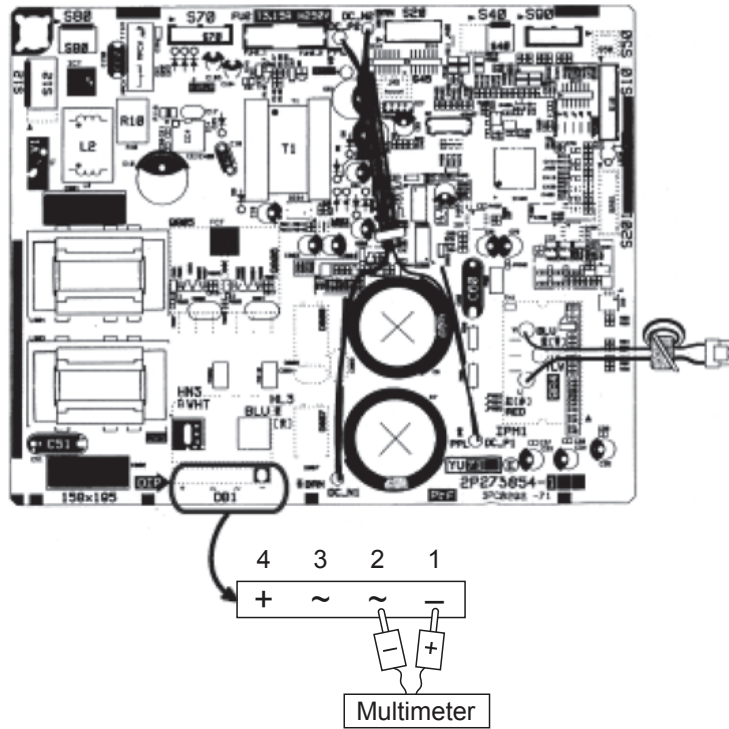

6.9 Power supply waveforms check procedures

Measure the power supply waveform between No. 1(Live) and No. 2(Neutral) on the terminal board, and check the waveform disturbance with oscilloscope.

- Check if the power supply waveform is a sine wave (Fig. 1).
- Check if there is waveform disturbance near the zero cross (sections circled in Fig. 2).

Fig. 1

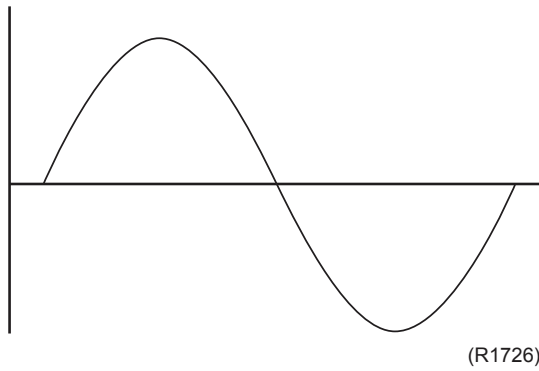
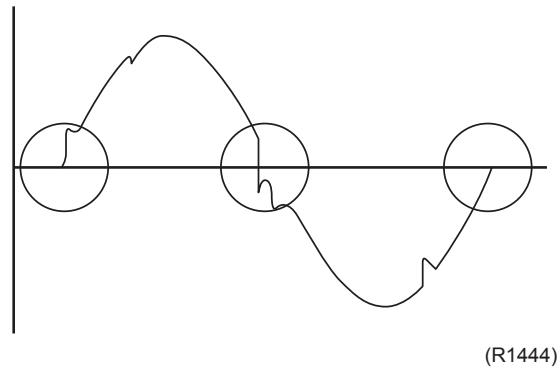

Fig. 2



6.10 Trial Operation and Field Settings

6.10.1 Tips for Servicing

6.10.1.1 Pump Down Operation

In order to protect the environment, be sure to conduct pump down operation when relocating or disposing of the unit.

<Details>

1. Remove the valve caps from the liquid stop valve and the gas stop valve.
2. Carry out forced cooling operation.
3. After 4 to 10 minutes, close the liquid stop valve with a hexagonal wrench.
4. After 2 to 3 minutes, close the gas stop valve and stop the forced cooling operation

09/12/18 class

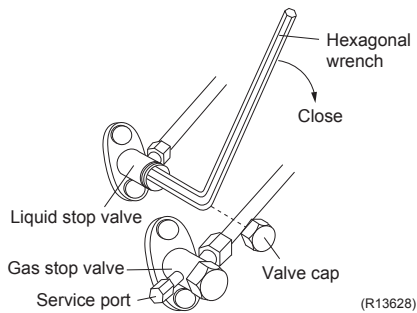

24 class

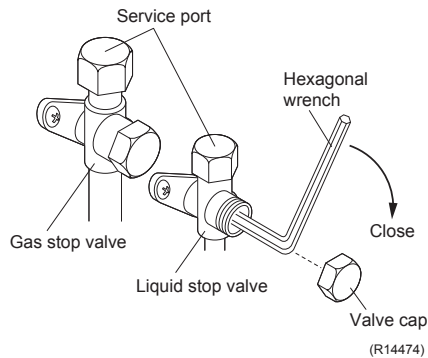

6.10.1.2 Forced Cooling Operation

Item	Forced Cooling
Conditions	The forced cooling operation is allowed when both the following conditions are met. 1) The outdoor unit is not abnormal and not in the 3-minute standby mode. 2) The outdoor unit is not operating.
Start	Press the forced cooling operation ON/OFF button (SW1) on the indoor unit for 5 seconds.
Command Frequency	Class 09/12: 58Hz Class 18/24: 66Hz
End	The forced cooling operation ends when any of the following conditions is fulfilled. 1)The operation ends automatically after 15 minutes. 2)Press the forced cooling operation ON/OFF switch (SW1) on the indoor unit again. 3)Press the ON/OFF button on the remote controller.
Others	Protection functions have priority over all other functions during forced cooling operation.

FTK(X)B model:

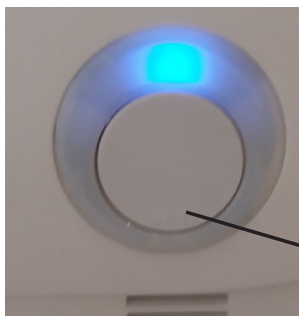

FTK(X)N model :



ON/OFF switch (SW1)

6.10.2 Trial Operation

1. Measure the supply voltage and make sure that it falls within the specified range.
2. Trial operation should be carried out in either cooling or heating operation.
3. Carry out the trial operation in accordance with the operation manual to ensure that all functions and parts, such as louver movement, are working properly.
 - The air conditioner requires a small amount of power in standby mode. If the system is not to be used for some time after installation, shut off the circuit breaker to eliminate unnecessary power consumption.
 - If the circuit breaker trips to shut off the power to the air conditioner, the system backs up the operation mode. The system then restarts operation with the previous operation mode when the circuit breaker is restored. [details refer to section 2.14 Auto Random Restart]
4. In cooling operation, select the lowest programmable temperature; in heating operation, select the highest programmable temperature.
 - Trial operation may be disabled in either operation mode depending on the room temperature.
 - After trial operation is complete, set the temperature to a normal level. [26 - 28°C (78.8 – 82.4°F) in cooling, 20 - 24°C (68 – 75.2°F) in heating]
 - For protection, the system does not start for 3 minutes after it is turned off.

6.10.3 Field Settings

6.10.3.1 Temperature Display Switch

- You can select Fahrenheit or Celsius for temperature display
- Press the TEMP ▲ and ▼ buttons simultaneously for 5 seconds to change the unit temperature display
- Default setting: Fahrenheit

6.10.4 Silicon Grease on Power Transistor / Diode Bridge

Apply the specified silicon grease to the heat radiation part of a power transistor / diode bridge when you replace an outdoor unit PCB. The silicon grease encourages the heat radiation of a power transistor / diode bridge.

<Details>

1. Wipe off the old silicon grease completely.
2. Apply the silicon grease evenly. See the illustration below for examples of application.
3. Tighten the screws of the power transistor / diode bridge.
4. Make sure that the heat radiation parts are firmly contacted to the radiation fin.

Note: smoke emission may be caused by bad heat radiation when the silicon grease is not appropriately applied.

■ OK: Evenly applied

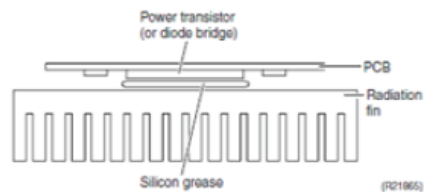

■ NG: Not evenly applied

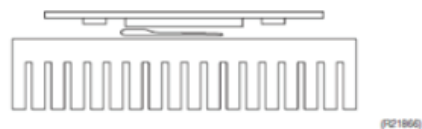

■ NG: Foreign matter is stuck.

