



Air Conditioning & Heating

ASPT SERIES

MULTI-POSITION, MULTI-SPEED, ECM-BASED AIR HANDLER WITH INTERNAL TXV 1½ TO 5 TONS



Contents

Air Handler Nomenclature.....	2
Heater Kit Nomenclature	2
Product Specifications.....	3
Dimensions	4
Airflow Data	6
Heat Kit Data.....	8
Wiring Diagram.....	15
Accessories	18

Product Features

- Internal factory-installed thermal expansion valves for cooling and heat pump applications
- Direct drive, multi-speed ECM blower motor
- All-aluminum evaporator coil
- Coil mounting track for quick repositioning
- Optimized for use with R-410A refrigerant
- Cabinet air leakage less than 2.0% at 1.0 inch H₂O when tested in accordance with ASHRAE standard 193
- Cabinet air leakage less than 1.4% at 0.5 inch H₂O when tested in accordance with ASHRAE standard 193
- AHRI certified; ETL listed
- Rigid SmartFrame™ cabinet
- Horizontal or vertical configuration capabilities
- 21" depth for easier attic access
- DecaBDE-free thermoplastic drain pan with secondary drain connections
- Screw-less sides and back helps to reduce condensation when installed in humid locations
- Foil-faced insulation covers the internal casing to reduce cabinet condensation
- Galvanized, leather grain-embossed finish
- Glue-less cabinet insulation retention
- Tool-less filter access
- Field Installed 3 kW – 25 kW electric heater kits available



COMPANY WITH QUALITY SYSTEM CERTIFIED BY DNV GL = ISO 9001 =

COMPANY WITH ENVIRONMENTAL SYSTEM CERTIFIED BY DNV GL = ISO 14001 =



* Complete warranty details available from your local dealer or at www.goodmanmfg.com. To receive the 10-Year Parts Limited Warranty, online registration must be completed within 60 days of installation. Online registration is not required in California or Québec.

	A	S	P	T	18	B	1	4	AA	
	1	2	3	4	5,6	7	8	10	11,12	
Brand	Single-piece Air Handler									Engineering * Major/ Minor Revisions * Not used for inventory management
Unit Application	Ceiling Mount PSC Motor Downflow PSC Motor Multi-Position Variable-Speed Motor Multi-Position PSC Motor Multi-Position EEM Motor Wall Mount PSC Motor									Refrigerant Charge 4 = R-410A
Cabinet Finish	Unpainted Painted Uncased									Electrical 1 208/240 V, 1 Phase, 60 Hz
Expansion Device	Flowrater Expansion Valve									Cabinet Width B 17½" C 21" D 24½"
										Nominal Capacity Range @ 13 SEER
										25, 29, 33 – 2 Tons 47 – 3½ Tons 35, 37 – 2½ Tons 49 – 4 Tons 37, 39 – 3 Tons 59, 61 – 5 Tons

	HKS	X	03	X	A	AA	
	1	2	3	4	5	6,7	
Unit Type	Heat Kit for Air Handlers						Revisions Engineering Revisions
Circuit Breaker	No circuit breaker Circuit Breaker						Phase A Single Phase 208 V E Three Phase 240 V B Single Phase 240 V F Three Phase 208/240 V C Single Phase 208/240 V G Three Phase 460 V D Three Phase 208 V
Heating Capacity @ 240 Volts	03 3.0 kW	15 14.4 kW	05 4.5 kW	19 19.2 kW wth 150F limit	06 6.0 kW	20 19.2 kW with 170F limit	Cabinet Size (MAX) C C Cabinet D D Cabinet X All Cabinet Sizes
	08 8.0 kW	25 25.0 kW	10 9.6 kW				

	ASPT 25B14*	ASPT 29B14*	ASPT 33C14*	ASPT 35B14*	ASPT 37B14*	ASPT 37C14*	ASPT 39C14*	ASPT 47C14*	ASPT 49C14*	ASPT 59C14*	ASPT 47D14*	ASPT 49D14*	ASPT 61D14*
NOMINAL RATINGS													
Cooling (Btu/h)	24,000	24,000	24,000	28,000	30,000	36,000	36,000	42,000	48,000	60,000	42,000	48,000	60,000
BLOWER													
Diameter	9½"	9½"	10⅝"	9½"	9½"	10⅝"	10⅝"	10⅝"	10⅝"	10⅝"	10⅝"	11⅝"	11⅝"
Width	6"	6"	8"	6"	6"	8"	8"	10⅝"	8"	10⅝"	10⅝"	10⅝"	10⅝"
COIL CONNECTIONS													
Liquid	⅜"	⅜"	⅜"	⅜"	⅜"	⅜"	⅜"	⅜"	⅜"	⅜"	⅜"	⅜"	⅜"
Suction	¾"	⅞"	⅞"	¾"	⅞"	⅞"	⅞"	⅞"	⅞"	⅞"	⅞"	⅞"	⅞"
Coil Drain Connect (FPT)	¾"	¾"	¾"	¾"	¾"	¾"	¾"	¾"	¾"	¾"	¾"	¾"	¾"
ELECTRICAL DATA													
Voltage	208/230	208/230	208/230	208/230	208/230	208/230	208/230	208/230	208/230	208/230	208/230	208/230	208/230
Minimum Circuit Ampacity	5.8 / 5.8	5.8 / 5.8	4.9 / 4.9	5.6/5.6	5.6 / 5.6	5.6 / 5.6	4.9/ 4.9	4.9 / 4.9	7.1 / 7.1	7.9 / 7.9	5.6 / 5.6	8.6 / 8.6	8.6 / 8.6
Max. Overcurrent Device (Amps)	15 / 15	15 / 15	15 / 15	15/15	15 / 15	15 / 15	15 / 15	15 / 15	15 / 15	15/15	15 / 15	15 / 15	15 / 15
Minimum VAC	197	197	197	197	197	197	197	197	197	197	197	197	197
Maximum VAC	253	253	253	253	253	253	253	253	253	253	253	253	253
Blower Motor													
Full Load Amps (FLA)	4.6	4.6	3.9	4.5	4.5	4.5	3.9	3.9	5.7	6.3	4.5	6.9	6.9
Horsepower (HP)	¾	¾	¾	¾	¾	¾	¾	¾	¾	1	¾	1	1
SHIP WEIGHT (LBS.)	116	129	118	129	129	144	118	144	125	144	155	167	167

*Airflow rate @.3 static

Note: Assumes dry coil; SCFM correction for wet coil = 4% (208V / 240V)

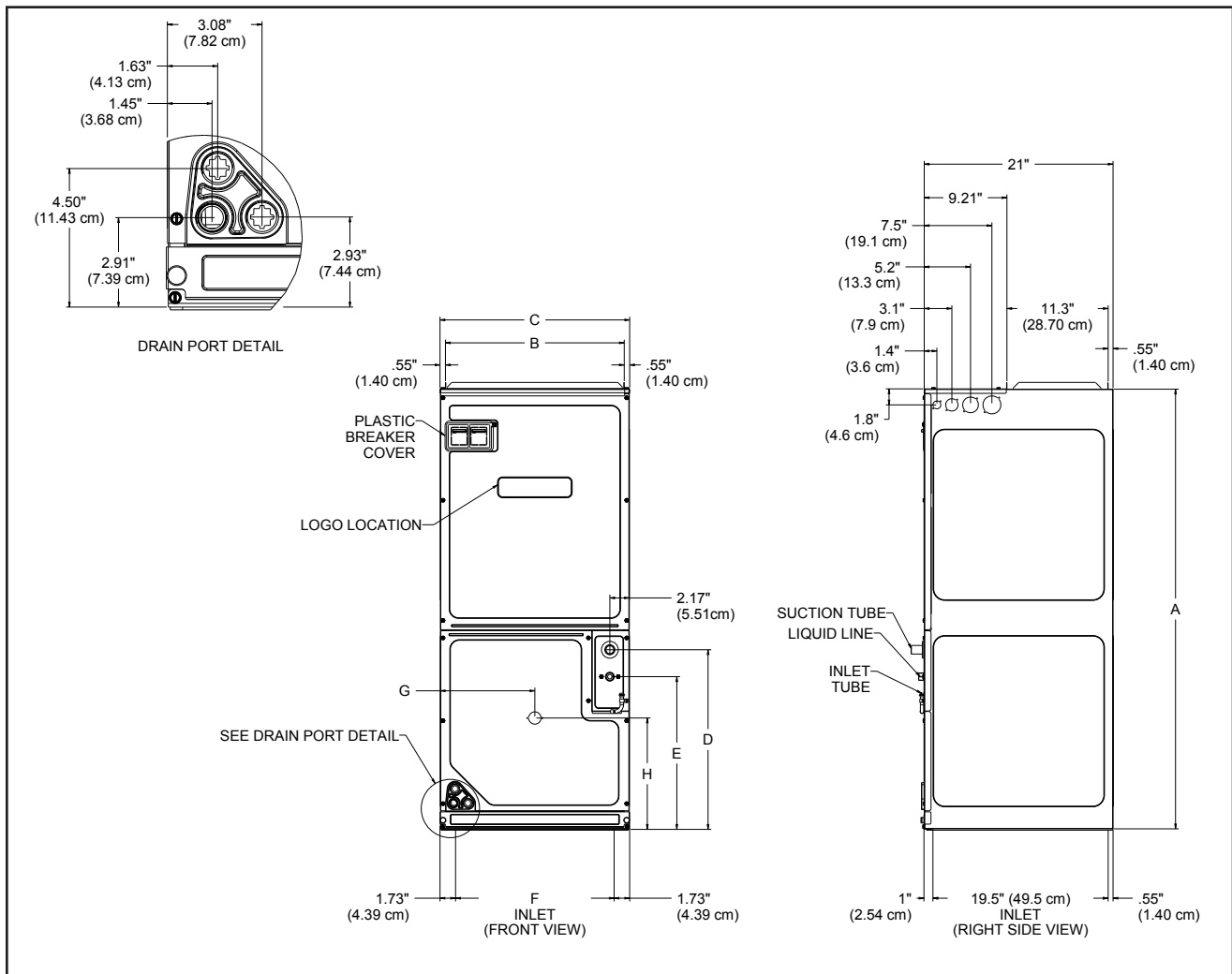

MODEL	A"	B"	C"	D"	E"	F"	G"	H"
ASPT25B14*	45	16%	17½	15¼	12	14	9	12 ¾
ASPT29B14*	53½	16%	17½	23 ⅜	20½	14	9	7 ⅝
ASPT33C14*	49	19%	21	17 ^{9/16}	14%	17½	10 ^{9/16}	12½
ASPT35B14*	45	16%	17½	15¼	12	14	9	12 ¾
ASPT37B14*	53½	16%	17½	23 ⅜	20½	14	9	7 ⅝
ASPT37C14*	53½	19%	21	21 ^{13/16}	18½	17½	10 ^{7/8}	6%
ASPT39C14*	49	19%	21	17 ^{9/16}	14%	17½	10 ^{9/16}	12½
ASPT47C14*	53½	19%	21	21 ^{13/16}	18%	17½	10 ^{7/8}	6%
ASPT47D14*	53½	23 ⅜	24½	21½	18 ^{5/16}	21	12%	6%
ASPT49C14*	49	19%	21	17 ^{9/16}	14%	17½	10 ^{9/16}	12½
ASPT49D14*	58	23 ⅜	24½	26%	22%	21	12%	13 ¼
ASPT59C14*	53½	19%	21	21 ^{13/16}	18%	17½	10 ^{7/8}	6%
ASPT61D14*	58	23 ⅜	24½	26%	22%	21	12%	13 ¼

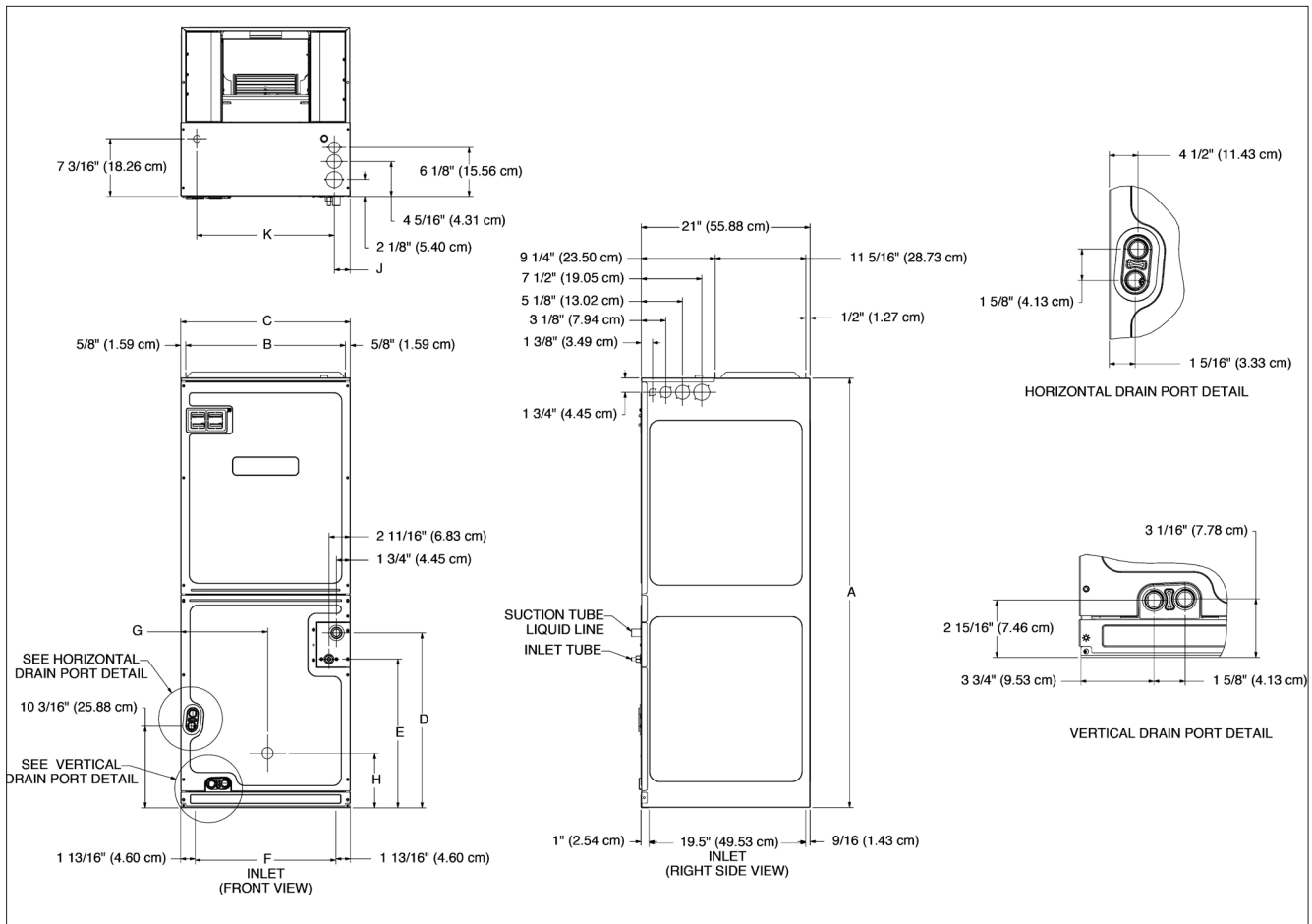

AIRFLOW DATA

MODEL	SPEED TAP	STATIC PRESSURE (IN W.C)									
		0.1	0.2	0.3	0.4	0.5	0.6	0.7	0.8	0.9	1.0
ASPT 25B14AB	1	640	585	580	545	510	490	410	340	280	
	2	800	765	725	700	670	645	595	565	490	
	3	840	805	800	760	740	700	670	625	580	
	4	985	950	920	885	850	815	800	760	725	
	5	1,475	1,440	1,400	1,375	1,335	1,305	1,270	1,240	1,150	
ASPT 29B14AB	1	595	590	565	530	505	455	380	305	260	
	2	790	775	745	705	665	625	585	515	445	
	3	865	820	790	770	735	695	645	595	530	
	4	1,015	980	955	925	880	840	795	770	720	
	5	1,505	1,465	1,430	1,410	1,385	1,350	1,315	1,285	1,220	
ASPT 33C14BA	1	865	685	615	540	480	410	335	270	215	
	2	935	875	820	785	720	655	600	550	490	
	3	1110	1050	1000	955	905	855	795	760	710	
	4	1355	1310	1260	1220	1180	1135	1095	1055	1005	
	5	1560	1515	1475	1430	1395	1370	1330	1295	1260	
ASPT 35B14AB	1	875	845	845	825	795	780	730	680	630	
	2	985	945	925	915	905	880	845	795	760	
	3	1,070	1,025	990	985	980	960	940	905	860	
	4	1,245	1,205	1,170	1,135	1,115	1,115	1,100	1,090	1,035	
	5	1,310	1,275	1,230	1,190	1,155	1,135	1,085	1,080	1,040	
ASPT 37B14AB	1	1,025	985	945	910	875	830	795	735	690	
	2	1,150	1,105	1,065	1,025	995	950	915	870	825	
	3	1,240	1,200	1,160	1,120	1,085	1,050	1,010	970	925	
	4	1,425	1,400	1,355	1,320	1,290	1,250	1,215	1,180	1,145	
	5	1,490	1,455	1,415	1,390	1,355	1,320	1,285	1,250	1,205	
ASPT 37C14AC	1	980	935	895	860	825	800	755	710	665	
	2	1,125	1,075	1,045	1,000	965	930	880	845	820	
	3	1,235	1,190	1,155	1,120	1,085	1,045	1,005	965	920	
	4	1,485	1,450	1,425	1,390	1,355	1,315	1,275	1,230	1,190	
	5	1,565	1,535	1,510	1,480	1,240	1,390	1,365	1,320	1,280	
ASPT 39C14BA	1	865	685	615	540	480	410	335	270	215	
	2	935	875	820	785	720	655	600	550	490	
	3	1110	1050	1000	955	905	855	795	760	710	
	4	1355	1310	1260	1220	1180	1135	1095	1055	1005	
	5	1560	1515	1475	1430	1395	1370	1330	1295	1260	
ASPT 47C14BA	1	955	895	855	840	780	735	675	615	560	
	2	1,100	1,050	1,005	965	925	870	815	770	705	
	3	1,205	1,160	1,120	1,075	1,035	990	940	885	830	
	4	1,445	1,410	1,365	1,320	1,275	1,235	1,190	1,140	1,095	
	5	1,525	1,480	1,435	1,400	1,360	1,320	1,275	1,230	1,180	
ASPT 47D14AC	1	1,055	1,015	950	895	830	785	730	680	620	
	2	1,210	1,165	1,110	1,070	1,015	960	900	840	785	
	3	1,335	1,290	1,250	1,205	1,145	1,100	1,050	980	910	
	4	1,625	1,580	1,530	1,495	1,455	1,405	1,350	1,295	1,230	
	5	1,720	1,670	1,625	1,580	1,540	1,490	1,435	1,390	1,325	
ASPT 49C14AC	1	1325	1280	1240	1200	1160	1115	1065	1025	985	
	2	1465	1420	1380	1355	1315	1280	1240	1195	1155	
	3	1505	1465	1425	1390	1355	1330	1290	1245	1205	
	4	1600	1565	1530	1490	1460	1425	1385	1365	1290	
	5	1690	1660	1625	1585	1555	1520	1485	1400	1250	
ASPT 49D14AC	1	1,485	1,435	1,380	1,320	1,265	1,200	1,230	1,015	930	
	2	1,570	1,525	1,480	1,430	1,370	1,315	1,235	1,155	1,035	
	3	1,680	1,600	1,570	1,555	1,475	1,430	1,360	1,280	1,185	
	4	1,800	1,765	1,715	1,670	1,625	1,590	1,510	1,465	1,390	
	5	2,215	2,160	2,120	2,085	2,040	2,000	1,970	1,930	1,865	

See notes on page 7.

MODEL	SPEED TAP	STATIC PRESSURE (IN W.C)									
		0.1	0.2	0.3	0.4	0.5	0.6	0.7	0.8	0.9	1.0
ASPT 59C14AC	1	1,370	1,330	1,295	1,255	1,215	1,180	1,140	1,100	1,060	
	2	1,535	1,500	1,465	1,430	1,405	1,370	1,335	1,300	1,210	
	3	1,680	1,645	1,615	1,575	1,545	1,510	1,440	1,330	1,205	
	4	1,905	1,855	1,780	1,690	1,605	1,515	1,425	1,330	1,205	
	5	1,940	1,855	1,775	1,700	1,605	1,505	1,420	1,320	1,205	
ASPT 61D14AC	1	1,545	1,495	1,440	1,390	1,335	1,260	1,180	1,080	1,030	
	2	1,745	1,695	1,625	1,575	1,525	1,475	1,400	1,360	1,275	
	3	1,905	1,855	1,815	1,770	1,725	1,670	1,635	1,575	1,500	
	4	2,155	2,105	2,090	2,045	2,000	1,970	1,935	1,890	1,830	
	5	2,340	2,310	2,265	2,220	2,185	2,165	2,120	2,080	2,030	

NOTES

- The chart is for information only. For satisfactory operation, external static pressure must not exceed value shown on rating plate.
- Use the CFM adjustment factors of .98 for horizontal left, .95 for horizontal right & .96 for downflow orientations.
- Assumes dry coil with filter in place.
- All models are shipped from the factory with the speed tap set on T4.
- Assumes dry coil; SCFM correction for wet coil = 4%
- All ASPT models are shipped from the factory with the speed tap set on T4.

HEAT KIT DATA

HEATER KIT MODEL		CIRCUIT 1			CIRCUIT 2			SINGLE-POINT KIT	
		HEATER AMPS	MCA ¹	MOP ²	HEATER AMPS	MCA ¹	MOP ²	MCA ¹	MOP ²
ASPT25B14AB		0/0	5.8/5.8	15/15	---	---	---	---	---
HKSX03XC- 208 V	No Breaker	10.8	19	20	---	---	---	---	---
HKSX05XC- 208 V		17.3	27	30	---	---	---	---	---
HKSX06XC- 208 V		21.6	33	35	---	---	---	---	---
HKSX08XC- 208 V		28.8	42	45	---	---	---	---	---
HKSX10XC- 208 V		34.6	49	50	---	---	---	---	---
HKSC05XC- 208 V	Breaker	17.3	27	30	---	---	---	---	---
HKSC08XC- 208 V		28.8	42	45	---	---	---	---	---
HKSC10XC- 208 V		34.6	49	50	---	---	---	---	---
HKSX03XC- 240 V	No Breaker	12.5	21	25	---	---	---	---	---
HKSX05XC- 240 V		20.0	31	35	---	---	---	---	---
HKSX06XC- 240 V		25	37	40	---	---	---	---	---
HKSX08XC- 240 V		33.3	47	50	---	---	---	---	---
HKSX10XC- 240 V		40.0	56	60	---	---	---	---	---
HKSC05XC- 240 V	Breaker	20.0	31	35	---	---	---	---	---
HKSC08XC- 240 V		33.3	47	50	---	---	---	---	---
HKSC10XC- 240 V		40.0	56	60	---	---	---	---	---
ASPT29B14AB		0/0	5.8/5.8	15/15	---	---	---	---	---
HKSX03XC- 208 V	No Breaker	10.8	19	20	---	---	---	---	---
HKSX05XC- 208 V		17.3	27	30	---	---	---	---	---
HKSX06XC- 208 V		21.7	33	35	---	---	---	---	---
HKSX08XC- 208 V		28.9	42	45	---	---	---	---	---
HKSX10XC- 208 V		34.7	49	50	---	---	---	---	---
HKSC05XC- 208 V	Breaker	17.3	27	30	---	---	---	---	---
HKSC08XC- 208 V		28.9	42	45	---	---	---	---	---
HKSC10XC- 208 V		34.7	49	50	---	---	---	---	---
HKSC15XA- 208 V		34.7	49	50	17.3	22	25	71	80
HKSX03XC- 240 V	No Breaker	12.5	21	25	---	---	---	---	---
HKSX05XC- 240 V		20	31	35	---	---	---	---	---
HKSX06XC- 240 V		25	37	40	---	---	---	---	---
HKSX08XC- 240 V		33.3	47	50	---	---	---	---	---
HKSX10XC- 240 V		40	56	60	---	---	---	---	---
HKSC05XC- 240 V	Breaker	20	31	35	---	---	---	---	---
HKSC08XC- 240 V		33.3	47	50	---	---	---	---	---
HKSC10XC- 240 V		40	56	60	---	---	---	---	---
HKSC15XB- 240 V		40	56	60	20	25	25	81	90
ASPT33C14BA		0/0	4.9/4.9	15/15	---	---	---	---	---
HKSX03XC- 208 V	No Breaker	10.8	18.4	20	---	---	---	---	---
HKSX05XC- 208 V		17.3	27	30	---	---	---	---	---
HKSX06XC- 208 V		21.7	32	35	---	---	---	---	---
HKSX08XC- 208 V		28.9	41	45	---	---	---	---	---
HKSX10XC- 208 V		34.7	48	50	---	---	---	---	---
HKSC05XC- 208 V	Breaker	17.3	27	30	---	---	---	---	---
HKSC08XC- 208 V		28.9	41	45	---	---	---	---	---
HKSC10XC- 208 V		34.7	48	50	---	---	---	---	---
HKSC15XB ³ - 208 V		34.7	48	50	17.3	21.7	25	69.9	70

See notes on page 14.

HEATER KIT MODEL		CIRCUIT 1			CIRCUIT 2			SINGLE-POINT KIT	
		HEATER AMPS	MCA ¹	MOP ²	HEATER AMPS	MCA ¹	MOP ²	MCA ¹	MOP ²
HKSX03XC- 240 V	No Breaker	12.5	21	25	---	---	---	---	---
HKSX05XC- 240 V		20	29.9	30	---	---	---	---	---
HKSX06XC- 240 V		25	36.1	40	---	---	---	---	---
HKSX08XC- 240 V		33.3	46.5	50	---	---	---	---	---
HKSX10XC- 240 V		40	54.9	60	---	---	---	---	---
HKSC05XC- 240 V	Breaker	20	29.9	30	---	---	---	---	---
HKSC08XC- 240 V		33.3	46.5	50	---	---	---	---	---
HKSC10XC- 240 V		40	54.9	60	---	---	---	---	---
HKSC15XB- 240 V		40	54.9	60	20	25	25	79.9	80
ASPT35B14AB		0/0	5.6/5.6	15/15	---	---	---	---	---
HKSX03XC- 208 V	No Breaker	10.8	19	20	---	---	---	---	---
HKSX05XC- 208 V		17.3	27	30	---	---	---	---	---
HKSX06XC- 208 V		21.7	33	35	---	---	---	---	---
HKSX08XC- 208 V		28.9	42	45	---	---	---	---	---
HKSX10XC- 208 V		34.7	49	50	---	---	---	---	---
HKSX15XC- 208 V		34.7	49	50	---	---	---	---	---
HKSC05XC- 208 V	Breaker	17.3	27	30	---	---	---	---	---
HKSC08XC- 208 V		28.9	42	45	---	---	---	---	---
HKSC10XC- 208 V		34.7	49	50	---	---	---	---	---
HKSC15XC- 208 V		34.7	49	50	17.3	22	25	71	80
HKSX03XC- 240 V	No Breaker	12.5	21	25	---	---	---	---	---
HKSX05XC- 240 V		20.0	31	35	---	---	---	---	---
HKSX06XC- 240 V		25	37	40	---	---	---	---	---
HKSX08XC- 240 V		33.3	47	50	---	---	---	---	---
HKSX10XC- 240 V		40.0	56	60	---	---	---	---	---
HKSX15XC- 240 V		40	56	60	---	---	---	---	---
HKSC05XC- 240 V	Breaker	20.0	31	35	---	---	---	---	---
HKSC08XC- 240 V		33.3	47	50	---	---	---	---	---
HKSC10XC- 240 V		40.0	56	60	---	---	---	---	---
HKSC15XC- 240 V		40.0	56	60	20	25	25	81	90
ASPT37B14AB		0/0	5.6/5.6	15/15	---	---	---	---	---
HKSX03XC- 208 V	No Breaker	10.8	19	20	---	---	---	---	---
HKSX05XC- 208 V		17.3	27	30	---	---	---	---	---
HKSX06XC- 208 V		21.7	33	35	---	---	---	---	---
HKSX08XC- 208 V		28.9	42	45	---	---	---	---	---
HKSX10XC- 208 V		34.7	49	50	---	---	---	---	---
HKSC05XC- 208 V	Breaker	17.3	27	30	---	---	---	---	---
HKSC08XC- 208 V		28.9	42	45	---	---	---	---	---
HKSC10XC- 208 V		34.7	49	50	---	---	---	---	---
HKSC15XA- 208 V		34.7	49	50	17.3	22	25	71	80
HKSX03XC- 240 V	No Breaker	12.5	21	25	---	---	---	---	---
HKSX05XC- 240 V		20	31	35	---	---	---	---	---
HKSX06XC- 240 V		25	37	40	---	---	---	---	---
HKSX08XC- 240 V		33.3	47	50	---	---	---	---	---
HKSX10XC- 240 V		40	56	60	---	---	---	---	---

See notes on page 14.

HEAT KIT DATA (CONT.)

HEATER KIT MODEL		CIRCUIT 1			CIRCUIT 2			SINGLE-POINT KIT	
		HEATER AMPS	MCA ¹	MOP ²	HEATER AMPS	MCA ¹	MOP ²	MCA ¹	MOP ²
HKSC05XC- 240 V	Breaker	20	31	35	---	---	---	---	---
HKSC08XC- 240 V		33.3	47	50	---	---	---	---	---
HKSC10XC- 240 V		40	56	60	---	---	---	---	---
HKSC15XB- 240 V		40	56	60	20	25	25	81	90
ASPT37C14BA		0/0	5.6/5.6	15/15	---	---	---	---	---
HKSX03XC- 208 V	No Breaker	10.8	19	20	---	---	---	---	---
HKSX05XC- 208 V		17.3	27	30	---	---	---	---	---
HKSX06XC- 208 V		21.7	33	35	---	---	---	---	---
HKSX08XC- 208 V		28.9	42	45	---	---	---	---	---
HKSX10XC- 208 V		34.7	49	50	---	---	---	---	---
HKSC05XC- 208 V	Breaker	17.3	27	30	---	---	---	---	---
HKSC08XC- 208 V		28.9	42	45	---	---	---	---	---
HKSC10XC- 208 V		34.7	49	50	---	---	---	---	---
HKSC15XA- 208 V		34.7	49	50	17.3	22	25	71	80
HKSC19CA- 208 V		34.7	49	50	34.7	43	45	92	100
HKSC15XF- 208 V ^		0	5.6	15	30	38	40	---	---
HKSX03XC- 240 V	No Breaker	12.5	21	25	---	---	---	---	---
HKSX05XC- 240 V		20	31	35	---	---	---	---	---
HKSX06XC- 240 V		25	37	40	---	---	---	---	---
HKSX08XC- 240 V		33.3	47	50	---	---	---	---	---
HKSX10XC- 240 V		40	56	60	---	---	---	---	---
HKSC05XC- 240 V	Breaker	20	31	35	---	---	---	---	---
HKSC08XC- 240 V		33.3	47	50	---	---	---	---	---
HKSC10XC- 240 V		40	56	60	---	---	---	---	---
HKSC15XB- 240 V		40	56	60	20	25	25	81	90
HKSC19CB- 240 V		40	56	60	40	50	50	106	110
HKSC15XF- 240 V ^		0	5.6	15	34.6	43	45	---	---
ASPT39C14BA		0.0/0.0	4.9/4.9	15/15	---	---	---	---	---
HKSX03XC- 208 V	No Breaker	10.8	18.4	20	---	---	---	---	---
HKSX05XC- 208 V		17.3	27	30	---	---	---	---	---
HKSX06XC- 208 V		21.7	32	35	---	---	---	---	---
HKSX08XC- 208 V		28.9	41	45	---	---	---	---	---
HKSX10XC- 208 V		34.7	48	50	---	---	---	---	---
HKSC05XC- 208 V	Breaker	17.3	27	30	---	---	---	---	---
HKSC08XC- 208 V		28.9	41	45	---	---	---	---	---
HKSC10XC- 208 V		34.7	48	50	---	---	---	---	---
HKSC15XB ³ - 208 V		34.7	48.2	50	17.3	21.7	25	69.9	70
HKSC19CH- 208 V		34.7	48.2	50	34.7	43.3	45	91.5	100
HKSC15XF- 208 V ^		0	4.9	15	30	37.5	40	---	---
HKSX03XC- 240 V	No Breaker	12.5	21	25	---	---	---	---	---
HKSX05XC- 240 V		20	29.9	30	---	---	---	---	---
HKSX06XC- 240 V		25	36.1	40	---	---	---	---	---
HKSX08XC- 240 V		33.3	46.5	50	---	---	---	---	---
HKSX10XC- 240 V		40	54.9	60	---	---	---	---	---

See notes on page 14.

HEATER KIT MODEL		CIRCUIT 1			CIRCUIT 2			SINGLE-POINT KIT	
		HEATER AMPS	MCA ¹	MOP ²	HEATER AMPS	MCA ¹	MOP ²	MCA ¹	MOP ²
HKSC05XC- 240 V	Breaker	20	29.9	30	---	---	---	---	---
HKSC08XC- 240 V		33.3	46.5	50	---	---	---	---	---
HKSC10XC- 240 V		40	54.9	60	---	---	---	---	---
HKSC15XB- 240 V		40	54.9	60	20	25	25	79.9	80
HKSC19CB- 240 V		40	54.9	60	40	50	50	104.9	110
HKSC15XF- 240 V ^		0	4.9	15	34.6	43	45	---	---
ASPT47C14BA		0/0	4.9/4.9	15/15	---	---	---	---	---
HKSX03XC- 208 V	No Breaker	10.8	18.4	20	---	---	---	---	---
HKSX05XC- 208 V		17.3	27	30	---	---	---	---	---
HKSX06XC- 208 V		21.7	32	35	---	---	---	---	---
HKSX08XC- 208 V		28.9	41	45	---	---	---	---	---
HKSX10XC- 208 V		34.7	48	50	---	---	---	---	---
HKSC05XC- 208 V	Breaker	17.3	27	30	---	---	---	---	---
HKSC08XC- 208 V		28.9	41	45	---	---	---	---	---
HKSC10XC- 208 V		34.7	48	50	---	---	---	---	---
HKSC15XA- 208 V		34.7	48.2	50	17.3	22	25	69.9	70
HKSC19CA- 208 V		34.7	48.2	50	34.7	43.3	45	91.5	100
HKSC15XF- 208 V ^		0	4.9	15	30	38	40	---	---
HKSX03XC- 240 V	No Breaker	12.5	21	25	---	---	---	---	---
HKSX05XC- 240 V		20	29.9	30	---	---	---	---	---
HKSX06XC- 240 V		25	36.1	40	---	---	---	---	---
HKSX08XC- 240 V		33.3	46.5	50	---	---	---	---	---
HKSX10XC- 240 V		40	54.9	60	---	---	---	---	---
HKSC05XC- 240 V	Breaker	20	29.9	30	---	---	---	---	---
HKSC08XC- 240 V		33.3	46.5	50	---	---	---	---	---
HKSC10XC- 240 V		40	54.9	60	---	---	---	---	---
HKSC15XB- 240 V		40	54.9	60	20	25	25	79.9	80
HKSC19CB- 240 V		40	54.9	60	40	50	50	105	110
HKSC15XF- 240 V ^		0	4.9	15	34.6	43	45	---	---
ASPT47D14AC		0/0	5.6/5.6	15/15	---	---	---	---	---
HKSX03XC- 208 V	No Breaker	10.8	19	20	---	---	---	---	---
HKSX05XC- 208 V		17.3	27	30	---	---	---	---	---
HKSX06XC- 208 V		21.7	33	35	---	---	---	---	---
HKSX08XC- 208 V		28.9	42	45	---	---	---	---	---
HKSX10XC- 208 V		34.7	49	50	---	---	---	---	---
HKSC05XC- 208 V	Breaker	17.3	27	30	---	---	---	---	---
HKSC08XC- 208 V		28.9	42	45	---	---	---	---	---
HKSC10XC- 208 V		34.7	49	50	---	---	---	---	---
HKSC15XA- 208 V		34.7	49	50	17.3	22	25	71	80
HKSC20DA- 208 V		34.7	49	50	34.7	43	45	92	100
HKSC15XF- 208 V ^		0	5.6	15	30	38	40	---	---
HKSC20XF- 208 V ^	0	5.6	15	37.5	47	50	---	---	

See notes on page 14.

HEAT KIT DATA (CONT.)

HEATER KIT MODEL		CIRCUIT 1			CIRCUIT 2			SINGLE-POINT KIT	
		HEATER AMPS	MCA ¹	MOP ²	HEATER AMPS	MCA ¹	MOP ²	MCA ¹	MOP ²
HKSX03XC- 240 V	No Breaker	12.5	21	25	---	---	---	---	---
HKSX05XC- 240 V		20	31	35	---	---	---	---	---
HKSX06XC- 240 V		25	37	40	---	---	---	---	---
HKSX08XC- 240 V		33.3	47	50	---	---	---	---	---
HKSX10XC- 240 V		40	56	60	---	---	---	---	---
HKSC05XC- 240 V	Breaker	20	31	35	---	---	---	---	---
HKSC08XC- 240 V		33.3	47	50	---	---	---	---	---
HKSC10XC- 240 V		40	56	60	---	---	---	---	---
HKSC15XB- 240 V		40	56	60	20	25	25	81	90
HKSC20DB- 240 V		40	56	60	40	50	50	106	110
HKSC15XF- 240 V ^		0	5.6	15	34.6	43	45	---	---
HKSC20XF- 240 V ^	0	5.6	15	43.3	54	60	---	---	
ASPT49C14AC		0.0/0.0	7.1/7.1	15/15	---	---	---	---	---
HKSX03XC- 208 V	No Breaker	---	---	---	---	---	---	---	---
HKSX05XC- 208 V		17.3	28.8	30	---	---	---	---	---
HKSX06XC- 208 V		21.7	34.2	35	---	---	---	---	---
HKSX08XC- 208 V		28.9	43.2	45	---	---	---	---	---
HKSX10XC- 208 V		34.7	50.5	60	---	---	---	---	---
HKSC05XC- 208 V	Breaker	17.3	28.8	30	---	---	---	---	---
HKSC08XC- 208 V		28.9	43.2	45	---	---	---	---	---
HKSC10XC- 208 V		34.7	50.5	60	---	---	---	---	---
HKSC15XB ³ - 208 V		34.7	50.5	60	17.3	21.7	25	72.1	80
HKSC19CH- 208 V		34.7	50.5	60	34.7	43.3	45	93.8	100
HKSC15XF- 208 V ^		0	7.1	15	30	37.5	40	---	---
HKSX03XC- 240 V	No Breaker	---	---	---	---	---	---	---	---
HKSX05XC- 240 V		20	32	35	---	---	---	---	---
HKSX06XC- 240 V		25	38	40	---	---	---	---	---
HKSX08XC- 240 V		33.3	49	50	---	---	---	---	---
HKSX10XC- 240 V		40	57	60	---	---	---	---	---
HKSC05XC- 240 V	Breaker	20	32	35	---	---	---	---	---
HKSC08XC- 240 V		33.3	49	50	---	---	---	---	---
HKSC10XC- 240 V		40	57	60	---	---	---	---	---
HKSC15XB- 240 V		40	57	60	20	25	25	82	90
HKSC19CB- 240 V		40	57	60	40	50	50	107	110
HKSC15XF- 240 V ^		0	7.1	15	34.6	43	45	---	---
ASPT49D14AC		0/0	8.6/8.6	15/15	---	---	---	---	---
HKSX03XC- 208 V	No Breaker	10.8	22	25	---	---	---	---	---
HKSX05XC- 208 V		17.3	30.3	35	---	---	---	---	---
HKSX06XC- 208 V		21.7	36	40	---	---	---	---	---
HKSX08XC- 208 V		28.9	45	45	---	---	---	---	---
HKSX10XC- 208 V		34.7	52	60	---	---	---	---	---

See notes on page 14.

HEATER KIT MODEL		CIRCUIT 1			CIRCUIT 2			SINGLE-POINT KIT	
		HEATER AMPS	MCA ¹	MOP ²	HEATER AMPS	MCA ¹	MOP ²	MCA ¹	MOP ²
HKSC05XC- 208 V	Breaker	17.3	30.3	35	---	---	---	---	---
HKSC08XC- 208 V		28.9	45	45	---	---	---	---	---
HKSC10XC- 208 V		34.7	52	60	---	---	---	---	---
HKSC15XB ³ - 208 V		34.7	52	60	17.3	22	25	74	80
HKSC20DH- 208 V		34.7	52	60	34.7	43	45	95	100
HKSC15XF- 208 V ^		0	8.6	15	30	38	40	---	---
HKSC20XF- 208 V ^		0	8.6	15	37.5	47	50	---	---
HKSC25DA- 208 V		52	74	80	35	43	45	117	125
HKSX03XC- 240 V	No Breaker	12.5	24	25	---	---	---	---	---
HKSX05XC- 240 V		20	34	35	---	---	---	---	---
HKSX06XC- 240 V		25	40	40	---	---	---	---	---
HKSX08XC- 240 V		33.3	50.3	60	---	---	---	---	---
HKSX10XC- 240 V		40	59	60	---	---	---	---	---
HKSC05XC- 240 V	Breaker	20	34	35	---	---	---	---	---
HKSC08XC- 240 V		33.3	50.3	60	---	---	---	---	---
HKSC10XC- 240 V		40	59	60	---	---	---	---	---
HKSC15XB- 240 V		40	59	60	20	25	25	84	90
HKSC20DB- 240 V		40	59	60	40	50	50	109	110
HKSC15XF- 240 V ^		0	8.6	15	34.6	43	45	---	---
HKSC20XF- 240 V ^		0	8.6	15	43.3	54	60	---	---
HKSC25DB- 240 V		60	84	90	40	50	50	134	150
ASPT59C14AC		0.0/0.0	7.9/7.9	15/15	---	---	---	---	---
HKSX03XC- 208 V	No Breaker	10.8	21	25	---	---	---	---	---
HKSX05XC- 208 V		17.3	30	30	---	---	---	---	---
HKSX06XC- 208 V		21.7	35	35	---	---	---	---	---
HKSX08XC- 208 V		28.9	44	45	---	---	---	---	---
HKSX10XC- 208 V		34.7	51	60	---	---	---	---	---
HKSC05XC- 208 V	Breaker	17.3	30	30	---	---	---	---	---
HKSC08XC- 208 V		28.9	44	45	---	---	---	---	---
HKSC10XC- 208 V		34.7	51	60	---	---	---	---	---
HKSC15XB ³ - 208 V		34.7	51	60	17.3	22	25	73	80
HKSC19CH- 208 V		34.7	51	60	34.7	43	45	95	100
HKSC15XF- 208 V ^	0	7.9	15	30	38	40	---	---	
HKSX03XC- 240 V	No Breaker	12.5	24	25	---	---	---	---	---
HKSX05XC- 240 V		20	33	35	---	---	---	---	---
HKSX06XC- 240 V		25	39	40	---	---	---	---	---
HKSX08XC- 240 V		33.3	50	50	---	---	---	---	---
HKSX10XC- 240 V		40	58	60	---	---	---	---	---
HKSC05XC- 240 V	Breaker	20	33	35	---	---	---	---	---
HKSC08XC- 240 V		33.3	50	50	---	---	---	---	---
HKSC10XC- 240 V		40	58	60	---	---	---	---	---
HKSC15XB- 240 V		40	58	60	20	25	25	83	90
HKSC19CB- 240 V		40	58	60	40	50	50	108	110
HKSC15XF- 240 V ^		0.0	7.9	15	34.6	43	45	---	---

See notes on page 14.

HEAT KIT DATA (CONT.)

HEATER KIT MODEL		CIRCUIT 1			CIRCUIT 2			SINGLE-POINT KIT	
		HEATER AMPS	MCA ¹	MOP ²	HEATER AMPS	MCA ¹	MOP ²	MCA ¹	MOP ²
ASPT61D14AC		0/0	8.6/8.6	15/15	---	---	---	---	---
HKSX03XC- 208 V	No Breaker	10.8	22	25	---	---	---	---	---
HKSX05XC- 208 V		17.3	30.3	35	---	---	---	---	---
HKSX06XC- 208 V		21.7	36	40	---	---	---	---	---
HKSX08XC- 208 V		28.9	45	45	---	---	---	---	---
HKSX10XC- 208 V		34.7	52	60	---	---	---	---	---
HKSC05XC- 208 V	Breaker	17.3	30.3	35	---	---	---	---	---
HKSC08XC- 208 V		28.9	45	45	---	---	---	---	---
HKSC10XC- 208 V		34.7	52	60	---	---	---	---	---
HKSC15XB ³ - 208 V		34.7	52	60	17.3	22	25	74	80
HKSC20DH- 208 V		34.7	52	60	34.7	43	45	95	100
HKSC15XF- 208 V ^		0	8.6	15	30	38	40	---	---
HKSC20XF- 208 V ^		0	8.6	15	37.5	47	50	---	---
HKSC25DA- 208 V		52	74	80	35	43	45	117	125
HKSX03XC- 240 V	No Breaker	12.5	24	25	---	---	---	---	---
HKSX05XC- 240 V		20	34	35	---	---	---	---	---
HKSX06XC- 240 V		25	40	40	---	---	---	---	---
HKSX08XC- 240 V		33.3	50.3	60	---	---	---	---	---
HKSX10XC- 240 V		40	59	60	---	---	---	---	---
HKSC05XC- 240 V	Breaker	20	34	35	---	---	---	---	---
HKSC08XC- 240 V		33.3	50.3	60	---	---	---	---	---
HKSC10XC- 240 V		40	59	60	---	---	---	---	---
HKSC15XB- 240 V		40	59	60	20	25	25	84	90
HKSC20DB- 240 V		40	59	60	40	50	50	109	110
HKSC15XF- 240 V ^		0	8.6	15	34.6	43	45	---	---
HKSC20XF- 240 V ^		0	8.6	15	43.3	54	60	---	---
HKSC25DB- 240 V		60	84	90	40	50	50	134	150

¹ Minimum Circuit Ampacity (Heater Amps + Motor Amps) X 1.25
² Maximum Overcurrent Protection = 2.25 X Motor Amps + Heater Amps
[^] Circuit 1: Single-phase for Air Handlers Circuit 2: Three-phase for HKR3 Heater Kits
 --- indicates Not Required

Note: The 208 or 240 in the heat kit part number field is for clarification of the nominal voltage for this model.
³ Notation is correct as XB because technically the 240V heater kit application can be used here without any issues.

HEATING kW CORRECTION FACTOR

SUPPLY VOLTAGE	240	230	220	210	208
CORRECTION FACTOR	1.00	0.92	0.84	0.77	0.75

Multiply the 240-volt heating capacity by correction factors.

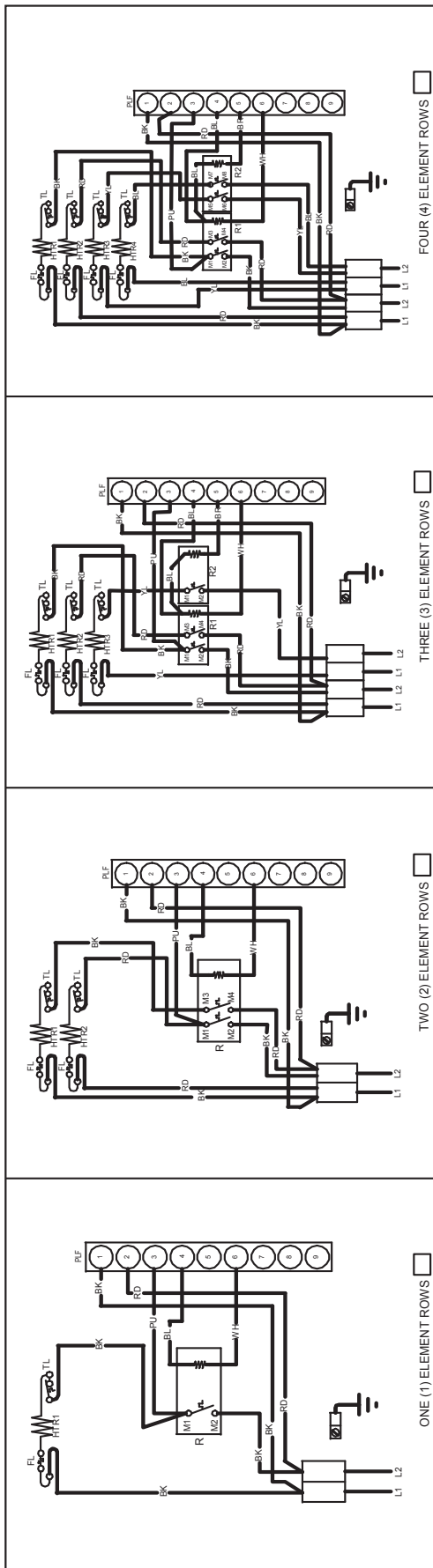

NOTE: WHEN INSTALLING HEATER KIT, ENSURE SPEED TAP DOES NOT EXCEED MINIMUM BLOWER SPEED (MBS) SPECIFIED FOR THE AIRHANDLER/HEATER KIT COMBINATION ON THIS UNIT'S S&R PLATE. AFTER INSTALLING OPTIONAL HEAT KIT, MARK A "X" IN THE BOX PROVIDED ABOVE. MARK ACCORDING TO NUMBER OF HEATER ELEMENT ROWS INSTALLED. NO MARK INDICATES NO HEAT KIT INSTALLED.

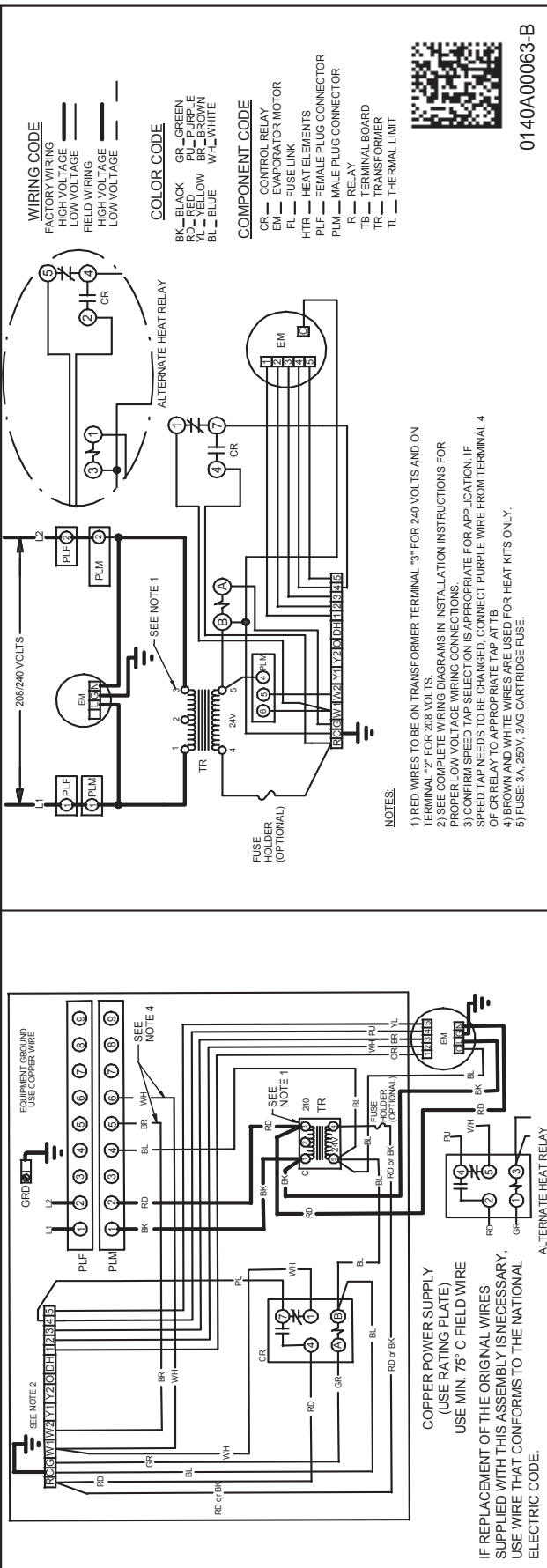

0140A00063-B

WARNING



High Voltage: Disconnect all power before servicing or installing this unit. Multiple power sources may be present. Failure to do so may cause property damage, personal injury, or death.

NOTE: The five element, 25 kW heater kit is not SHOWN ABOVE.

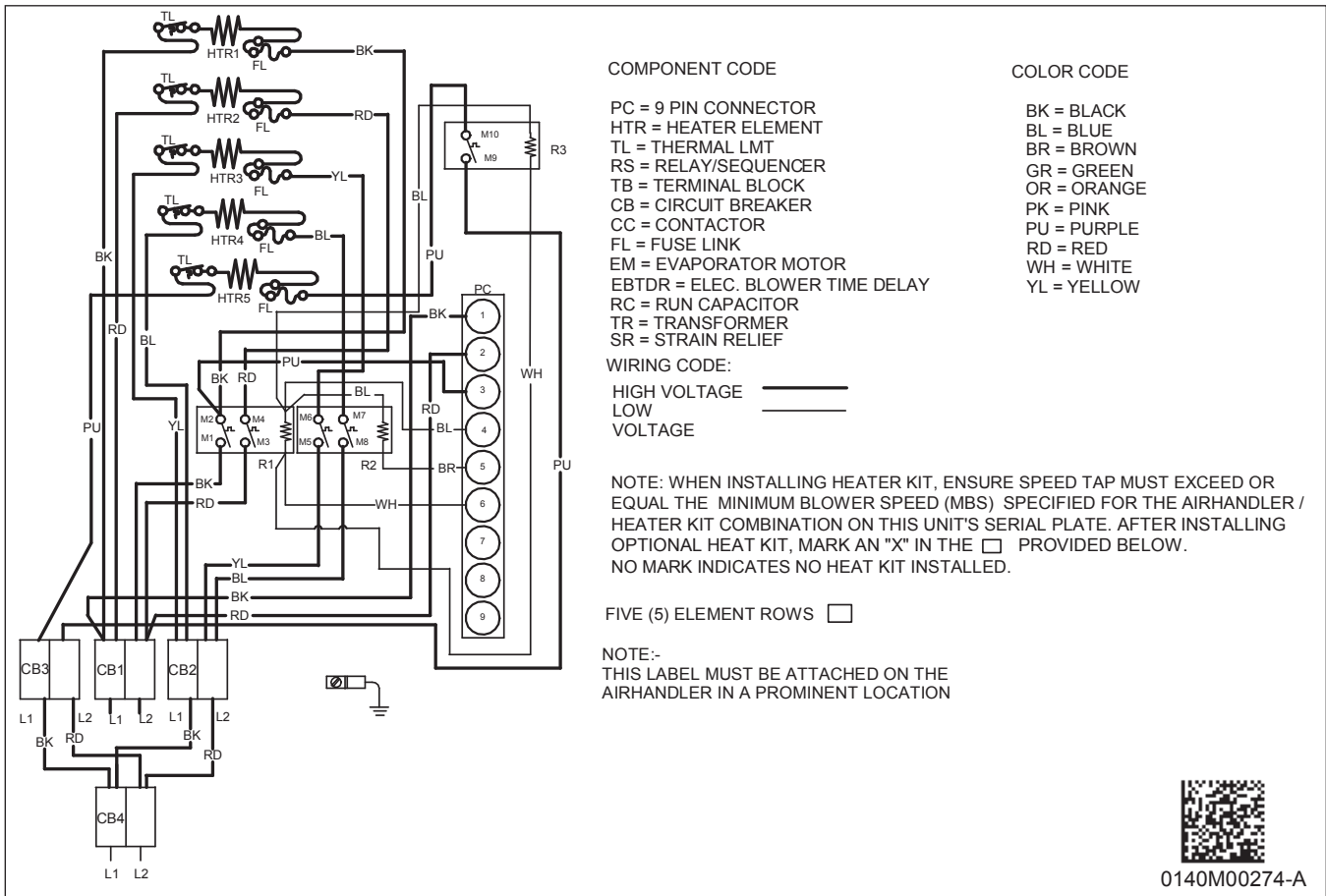
FIVE-ELEMENT HEATER KIT WIRING DIAGRAM



Wiring is subject to change. Always refer to the wiring diagram on the unit for the most up-to-date wiring.

	WARNING	<p>High Voltage: Disconnect all power before servicing or installing this unit. Multiple power sources may be present. Failure to do so may cause property damage, personal injury, or death.</p>	
---	----------------	--	---

NOTE: WHEN INSTALLING HEATER KIT, ENSURE SPEED TAP MUST EXCEED OR EQUAL THE MINIMUM BLOWER SPEED (MBS) SPECIFIED FOR THE AIRHANDLER/HEATER KIT COMBINATION ON THIS UNIT'S SERIAL PLATE. AFTER INSTALLING OPTIONAL HEAT KIT, MARK AN "X" IN THE PROVIDED BELOW. NO MARK INDICATES NO HEAT KIT INSTALLED.

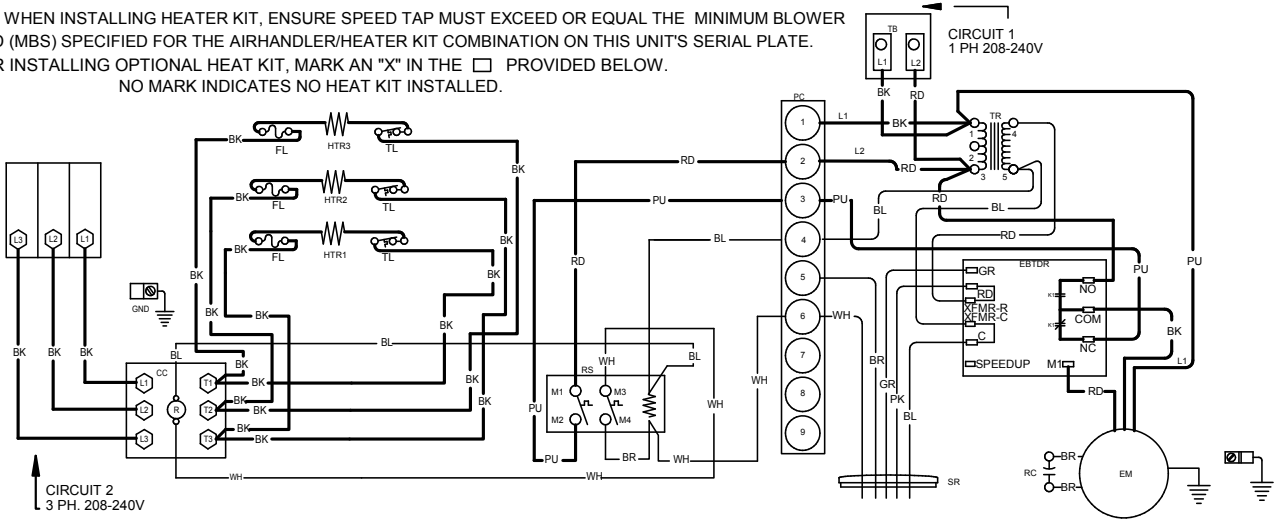

NOTE:- THIS LABEL MUST BE ATTACHED ON THE AIRHANDLER IN A PROMINENT LOCATION

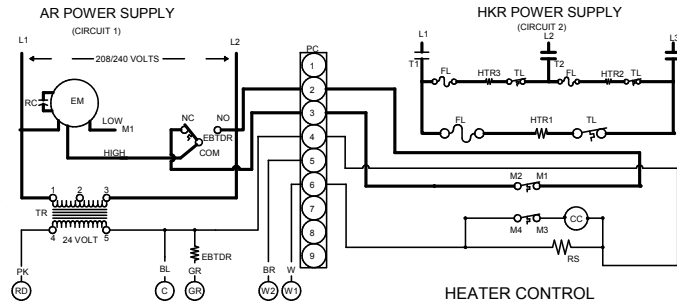

COMPONENT CODE		COLOR CODE	
HTR	HEAT ELEMENT	BK	BLACK
EM	EVAPORATOR MOTOR	BL	BLUE
EBTDR	ELEC. BLOWER TIME DELAY RELAY	BR	BROWN
RS	RELAY/SEQUENCER	GR	GREEN
TL	THERMAL LIMIT	OR	ORANGE
TR	TRANSFORMER	PK	PINK
FL	FUSE LINK	PU	PURPLE
CC	CONTACTOR	RD	RED
PC	9-PIN CONNECTOR	WH	WHITE
SR	STRAIN RELIEF	YL	YELLOW
CB	CIRCUIT BREAKER		

WIRING CODE	
—————	HIGH VOLTAGE
—————	LOW VOLTAGE



Wiring is subject to change. Always refer to the wiring diagram on the unit for the most up-to-date wiring.

	WARNING	High Voltage: Disconnect all power before servicing or installing this unit. Multiple power sources may be present. Failure to do so may cause property damage, personal injury, or death.	
--	----------------	---	--

DOWNFLOW INSULATION KIT

DFK-B	DFK-C	DFK-D
ASPT24B14**	ASPT42C14**	ASPT42D14**
ASPT35B14**	ASPT48C14**	ASPT48D14**
		ASPT60D14**
		ASPT61D14**

FILTERS

CHASSIS	PART #	SIZE
B	ALFH16201E	16.0" x 20.0"
C	ALFH1912201E	19.5" x 20.0"
D	ALFH20231E	23.0" x 20.0"

SINGLE POINT WIRING KIT (SPW-01)

HEATER KIT MODEL	SPWK-B	SPWK-C	SPWK-D
HKSC15XC-208V	ASPT35B14**		
HKSC15XC-240V			
HKSC15XB-240V	ASPT29B14**	ASPT37C14** ASPT47C14**	ASPT47D14**
HKSC15XA-208V			
HKSC19CA-208V			
HKSC19CB-240V			
HKSC19CB-240V		ASPT39C14** ASPT49C14** ASPT59C14**	
HKSC19CH-208V			
HKSC20DA-208V			ASPT47D14**
HKSC20DB-240V			
HKSC15XB 3- 208 V		ASPT33C14** ASPT39C14** ASPT49C14** ASPT59C14**	ASPT49D14** ASPT61D14**
HKSC15XB-240V			
HKSC20DB-240V			
HKSC20DH-208V			
HKSC25DA-208V			
HKSC25DB-240V			