

Premier Series Programmable Thermostats

MODEL 5200 Up to 2 Heat / 2 Cool
7 Day, 5 - 2 Day or Non-Programmable
Conventional and Heat Pump

**Before Installing, Programming or Operating,
PLEASE READ ALL INSTRUCTIONS**

- 1 Specifications
- 2 Installation
- 3 Programming Installer Settings
- 4 Testing Your New Thermostat
- 5 Programming User Settings
- 6 Setting Your Energy Saving Programs
- 7 Temperature Adjustment
- 8 Additional Operation Features
- 9 Battery Replacement
- 10 Troubleshooting
- 11 Wiring Diagrams

WARNING

Important Safety Information

- Always turn off power to the air conditioning or heating system prior to installing, removing, cleaning or servicing thermostat.
- This thermostat requires either 24 Volts AC Power or two (2) properly installed “AA” alkaline batteries for normal operation and control of the heating or cooling system.
- This thermostat requires two (2) properly installed “AA” alkaline batteries to retain clock setting in the event of loss of AC Power due to a power outage or rolling blackouts when used as a hardwired thermostat.
- This thermostat should only be used as described in this manual. Any other use is not recommended and will void the warranty.

1 Specifications

- Electrical Rating: 24 Volt AC (18-30 Volt AC)
1 amp maximum load per terminal
3 amp maximum load (all terminals)
- Control Range: 45° - 90° F. (7° - 32° C)
- Accuracy: +/- 1° F. (+/- .5° C)
- AC Power: 18-30 Volt AC
- DC Back-Up Power: 3.0 Volt DC (2 AA Alkaline batteries included)

1 Specifications *cont.*

- Compatibility: Compatible with low voltage multi-stage gas, oil or electric heating or cooling systems, including multi-stage heat pumps.
- Terminations: R, O, B, C, Y1, Y2, E/W1, W2, G, L

2 Installation

Replacing Existing Thermostat

Most thermostats have three parts:

- The cover, which may snap or hinge over the existing thermostat.
 - The electronics or body, which controls the existing system.
 - The sub-base, where the wires attach through the wall to the existing system.
1. Always turn off power to the air conditioning and heating system prior to removing existing thermostat.
 2. Carefully remove the cover and electronics body from the old thermostat sub-base. Depending on the brand, these parts may pull off or need to be unscrewed. The old sub-base should remain wired and on the wall until steps 4 and 5.
 3. Label every old wire with the letter of the connection to which the wire is attached. Example letters are R, M, and Y etc. Depending on the brand of the old thermostat, your letters may be different.
 4. After labeling the old wires, loosen each connection and remove them from old sub-base. Secure the wires to prevent them from slipping into the hole in the wall.
 5. Remove the old sub-base from the wall, again being careful that the wires do not slip into the hole in the wall.
 6. Use the chart below to determine the new thermostat connections. As an example, if the old thermostat had a G or F connection, it goes to G on the new thermostat. Using a pencil and the chart below, circle the letter of each wire removed from the old thermostat.

Old Terminal from Existing Thermostat	New Terminal for New Thermostat	Terminal Description
R, V-VR, or VR-R	R	24 Volt AC
O or R	O	Reversing Valve (Cooling)
B	B	Reversing Valve (Heating)
C, X	C	24 Volt AC, Transformer Common
Y, Y1 or M	Y1	Stage 1 Compressor
Y2	Y2	Stage 2 Compressor
E, W1 or W-U	E/W1	Emergency Heat / 1st Stage Heat
W2	W2	Stage 2 Heating
G or F	G	Fan Control
L or X	L	System Status LED

NOTE: This thermostat is designed for use with 24 Volt-AC low voltage multi-stage gas, oil or electric heating or cooling systems, including multi-stage heat pump systems. Do not use this thermostat on applications with voltages above 30 Volts AC.

2 Installation *cont.*

Installing New Thermostat

NOTE: When installing this thermostat in a new location, following a few simple guidelines and the applicable building codes will give the best results. Install the thermostat in a location that provides good airflow by avoiding areas behind doors, near corners, air vents, direct sunlight or heat generating devices. The wiring must conform to all building codes and ordinances as required by local and national code authorities having jurisdiction for this installation.

1. Always turn off the power to the air conditioning and heating system prior to installing this thermostat.
2. Locate the release latch on the bottom (not the back) of the thermostat. Press the release latch in and separate the body from the sub-base of the thermostat.
3. Set the thermostat electronics and cover down on a clean surface. Place the sub-base on the wall in the desired location.
4. Using the slotted mounting holes in the sub-base, mark the placement of the mounting holes through the slots and onto the wall. Ensure the wires come out of the wall into the center hole of the sub-base.
5. After verifying the drill will not damage items in the wall, use a 3/16 drill to create the mounting holes. Gently tap the supplied plastic anchors into the holes in the wall.
6. Place the thermostat sub-base against the wall in the desired location. Ensure the thermostat is level, the wires are inserted in the opening, and the mounting holes are aligned with the slots on the sub-base.
7. Fasten sub-base to wall using the supplied screws into the plastic wall anchors.
8. Connect wires to the quick wiring terminal blocks. Use the wiring diagram chart to ensure the old and new connections are correct.
9. To prevent electrical shorts and potential damage to the thermostat, make sure all wire connections are secure and not touching each other.
11. Flip the front thermostat cover open and open the battery compartment door.
12. Locate the positive [+] ends of the batteries and match them with the positive [+] terminals located in the battery compartment. Install the two new "AA" alkaline batteries (supplied). Close battery compartment door.
13. Restore system power and proceed to Programming Installer Settings.

3 Programming Installer Settings

Default Thermostat Settings

At initial power up or after Installer **CLEAR** is pressed, the thermostat is reset to factory defaults. Installer **CLEAR** is located on the circuit board.

Function	Status After Clear
Temperature Hold	Permanent and Temporary Hold Cleared
Clock	12:00 p.m., Monday
Room Temperature	70° F (21.0° C), to be renewed within 5 seconds.
Set Point Temperature	<u>According to System Switch</u> 62° F (17.0° C) for Heat, Emergency Heat & Off 83° F (28.0° C) for Cool
Temperature Scale	°F
Operating Program	DAY program, Monday
Low Battery Warning	Off, to be renewed within 5 seconds
AC Interrupted Warning	Off, to be renewed within 5 seconds
1st Stage Differential	0.5° F (0.25° C)
2nd Stage Differential	2° F (1.0° C)
Programming	7 Day, 4 Event
Residual Cooling Fan Delay	60 Seconds
Short Cycle Protection Timer	On, Reset
Adaptive Recovery Mode	Off
Output Relays	Off
Extended Hold	Indefinite
Filter Check Monitor	0 days-off, Time reset
Keypad Lock	Unlocked
System Type	Conventional, Single Stage
1st Stage Heat Fan Control	Gas
2nd Stage Heat Fan Control	Electric
Fossil Fuel Compressor Lock	Off
Outage Protection Timer	Off, reset
AC Interrupt Warning Mode	OFF

3 Programming Installer Settings *cont.*

When the User **RESET** button is pressed, the following options will reset to the factory defaults. All other settings are saved when the **RESET** button is pressed.

Function	Status After RESET
Programming	Default setting depending on programming mode setting (see Section 4). For manual mode: Heat - 62° F, Cool - 83° F.
Clock	12:00 p.m., Monday
1st Stage Differential	0.5° F (0.25° C)
2nd Stage Differential	2° F (1.0° C)
Filter Check Monitor	0 days-off, Time reset
Keypad Lock	Unlocked
Temperature Hold	Permanent and Temporary Hold Cleared, Reset to Long Hold
Short Cycle Protection Timer	On, Reset

Setting Thermostat Installer Options

The Installer Options section allows the system and programming parameters to be set up at installation. The Installer Options mode is menu driven. As the different options are programmed you may eliminate specific options. For example, if the system is set to single stage heat pump in Option 3, the selection for first stage fan control will no longer be available.

To enter the installer settings mode:

Press and hold the **RETURN** and **V** buttons at the same time for 3 seconds until installer option 1 (Programming Mode) is displayed. Pressing the **▲** or **V** buttons will scroll between choices. To scroll to the next installer option, press the **RETURN** button. To scroll backwards, press the **PROG** button. The thermostat will return to normal operating mode after the last Installer Option mode has been set or by pressing the **RETURN** and **PROG** buttons at the same time.

NOTE: The thermostat will return to normal operating mode automatically after 30 seconds if no key is pressed.

NOTE: Any changes to Installer Option 3 (System Type) will cause Options 4, 5, 6, 9 and 10 to reset to the default values that are dependent on system selection. Any changes to Installer Options 1 or 11 will cause all User Options and Programming to reset to their default values if the User Options were previously programmed. See Section 5.

3 Programming Installer Settings *cont.*

Installer Options Factory Default Option Comment

Installer Options	Factory Default	Option	Comment
1 – Programming Mode	PRO7	PRO7, PRO52 PRONO	Selects the programming mode: 7 day, 5-2 day or non-prog.
2 – Enable / Disable ARM™	RECOF	RECON, RECOF	Enables or disables early recovery. Not available in non-prog. mode.
3 – System Type	11C	11C, 22C, 11HP 22HP	Selects single stage conventional, 2 stage conventional, single stage heat pump or 2 stage heat pump.
4 – First Stage Fan Control	1HG	1HG, 1HE	Not available with a heat pump system. Selects between 1st stage gas or electric heat.
5 – Second Stage Fan Control	2HE	2HE, 2HG	Only available with a 2nd stage heat pump system.
6 – Fossil Fuel Backup Option	RU HE	RU HE, RU HG	Only available with a 2nd stage heat pump system. Locks out 1st stage during 2nd stage heat call for fossil fuel back-up system (AUHG) With an electric back-up system (AUHE), both stages will run.
7 – Residual Cooling Fan Off Delay	FAN50	FAN00, FAN30, FAN60, FAN90	Selects 0, 30, 60 or 90 seconds as the time the fan will stay on after the cooling system has satisfied the set point temperature and has turned off the compressor.
8 – Short Cycle Protection	SSPON	SSPON, SSPOF	Selects SSPON (5 minutes) or SSPOF (off) for the compressor short cycle protection.
9 – Compressor Power Outage Protection	COPDF	COPDF, COPDN	Only available with 2nd stage heat pump and AC power connected. Select between compressor lock off or compressor lock on.
10 – AC Power Interrupt Warning	ACIOF	ACIOF, ACION	Only available when thermostat is installed as a hardwired unit. Select between turning the AC power interrupt warning off or on.
11 – Temperature Scale	DEGF	DEGF, DEGC	Selects either Fahrenheit or Celsius.

Description of Options

1. Selects the programming mode, either full 7 day or 5-2 day (weekday-weekend) programming or non-programmable.
2. Enables or disables the ARM™ feature. During ARM™, room temperature is recovered gradually by turning on the heating or cooling before the end of the set back period. In a multi-stage configuration, room temperature is recovered gradually by using only the first stage heating or cooling until the last 20 minutes, to minimize the use of the 2nd stage heating or cooling. The set point temperature is changed to that of the upcoming comfort program temperature. ARM™ does not operate when the unit is in the temporary or permanent HOLD mode if the program is temporarily overridden or if emergency heat is selected for multi-stage heat pumps. If the ARM™ feature is disabled the thermostat will recover the set point temperature at the programmed set point time after the setback period ends. *(continued on page 6)*

3 Programming Installer Settings *cont.*

3. Selects single stage conventional (11C), 2 stage conventional (22C), single stage heat pump (11HP), or 2 stage heat pump (22HP). Any change made to the system type resets Installer Options 4, 5, 6, 9 and 10 to their default values dependent on system selected.
4. Selects between 1st stage gas or electric heat. This Installer Option is not available with a heat pump system.
5. Selects between 2nd stage gas or electric heat. This Installer Option is only available with a 2 stage heat pump system.
6. For heat pump units with an electric auxiliary stage, both the first and second stages of heating will run when a call for second stage heat is made. For heat pump units with a fossil fuel auxiliary stage, the first stage will be locked out one minute after a second stage heat call, and the second stage will only be used.
7. During the **COOL** mode of normal operation the fan will stay on for 60 seconds after the cooling system has satisfied the set point temperature and has turned off the compressor. This allows the system to provide higher efficiency during cooling operation.
8. This thermostat includes an automatic compressor protection feature to avoid potential damage to the cooling system from short cycling. This thermostat automatically provides a delay after turning off the cooling system output to protect the compressor. This protection is also present in the heat mode of operation on single stage heat pump systems to protect the compressor. To disable this feature, set this option to SSPOF (off).
9. This thermostat provides cold weather compressor protection by locking out the compressor stage (1st stage) of heating for a period of time after a power outage greater than 60 minutes. The lockout period is one hour less than the outage time, up to a maximum of 12 hours. During that period of time, the auxiliary heat stage will still be available to maintain the set point temperature. The compressor lockout can be disabled by setting this option to **OFF**.
10. Select between turning the AC power interrupt warning off or on. During a power loss, the thermostat will display an outage warning. The system clock will continue to run, and all settings will be maintained until the outage period is over. This Installer Option is only available when thermostat is installed as a hardwired unit.
11. Selects preferred temperature scale of either °F or °C.

4 Testing Your New Thermostat

WARNING! Read *BEFORE* Testing

- Do not short (or jumper) across terminals on the gas valve or at the heating or cooling system control board to test the thermostat installation. This could damage the thermostat and void the warranty.
- Do not select **COOL** mode of operation if the outside temperature is below 50° F (10° C). This could possibly damage the controlled cooling system and may cause personal injury.
- This thermostat includes an automatic compressor protection feature to avoid potential damage to the cooling system from short cycling. This thermostat automatically provides a 5-minute delay after turning off the cooling or heating system output to protect the compressor. This delay can be disabled in Installer Option 8 (see Section 3).

4 Testing Your New Thermostat *cont.*

NOTE: Test your thermostat prior to programming any user settings. Pressing the Installer **CLEAR** button will reset the thermostat to all factory defaults. Pressing the User **RESET** button will erase all user settings and return them to their default values.

1. Place the system switch in the **HEAT** position.
2. Press the **▲** button on the keypad until the set point temperature setting is a minimum of 3 degrees higher than the current room temperature. The heating system should start within several seconds. The fan may not turn on immediately due to the heating system built-in fan delay.
3. Place the system switch in the **OFF** position. The heating system should stop within several seconds.
4. Place the system switch in the **COOL** position.
5. If the compressor has previously been running, then you must wait five minutes. You can also press the **RESET** button to bypass this feature for initial testing purposes. Pressing the **RESET** button will erase any user entries previously programmed.
6. Press the **▼** button on the keypad until the set point temperature is a minimum of 3 degrees lower than the current room temperature.
7. The cooling system should start within several seconds. Place the system switch in the **OFF** position. The cooling system should stop within 90 seconds (dependent on the setting of the Residual Cooling Fan Feature).
8. Place the fan switch in the **ON** position. The system blower should start.
9. Place the fan switch in the **AUTO** position. The system blower should stop.

5 Programming User Settings

Setting Current Time of Day and Day of Week

NOTE: It is important for you to set the current time of day (note AM/PM indicator in display), and the current day of week correctly to avoid problems with program execution.

1. When in normal operating mode, press the **DAY/TIME** keypad button. The LCD display will be cleared except for the time, am/pm indicator and the day of the week. The hour portion of the time will flash.
2. Press the **▲** or **▼** button to set the current hour.
3. Press the **DAY/TIME** button again. The minute portion of the time will flash.
4. Press the **▲** or **▼** button to set the current minute.
5. Press the **DAY/TIME** button again. The day of the week indicator will flash.
6. Press the **▲** or **▼** button to set the current day of the week.

NOTE: The thermostat will return to normal operating mode automatically after 30 seconds if no key is pressed. It will also return to normal operating mode immediately if the **RETURN** button is pressed.



5 Programming User Settings *cont.*

Setting Thermostat User Options

The default user options are compatible with most systems and applications. They are normally set at the time of installation and usually do not require any modification under normal operating conditions.

NOTE: If at any time while in the user options mode, you do not wish to make any further changes, you can wait 30 seconds without pressing any keys to return to the normal operating mode.

NOTE: The first and second stage differential settings are the same for both the heating and cooling systems.

Setting the First and Second Stage Differentials

First Stage Differential

The default setting is 0.5° F (0.25° C). The room temperature must change 0.5° F (0.25° C) from the set point temperature before the thermostat will call for heating or cooling.

- In normal operating mode, press and hold the **RETURN** button for 4 seconds. The LCD display will show "d1 x", where "x" equals the °F / °C differential setting. This is the current temperature differential setting.
- Press the **▲** or **▼** button to set the temperature differential to your desired setting of 0.5°, 1°, or 2° F (0.3°, 0.5°, or 1.0° C).



Second Stage Differential – Only Available on 2 Stage Systems

The default setting is 2° F (1.0° C). This means that the room temperature must change 2° F (1.0° C) in addition to the first stage differential setting before the thermostat will initiate the system in heating or cooling.

- Press the **RETURN** button again and the LCD display will show "d2 x", where "x" equals the °F / °C differential setting. This is the current second stage differential setting.
- Press the **▲** or **▼** button to set the second stage differential to your desired setting of 2°, 3°, 4°, 5°, or 6° F (1.0°, 1.5°, 2.0°, 2.5°, or 3.0° C).



Setting the Extended Hold Time (see also section 8)

The default setting is Long (indefinite) Hold. If the **HOLD** feature is activated, the current set point will be held until **HOLD** is released.

- After pressing the **RETURN** button again, the display will show "HOLD LG", where "LG" is indefinite hold.
- Press the **▲** or **▼** button to change the Extended Hold time from indefinite (**LG**) to 24 hours (**SH**).
- Press the **RETURN** button again to set the Filter Check Monitor, or wait 30 seconds for the thermostat to return to the normal mode.

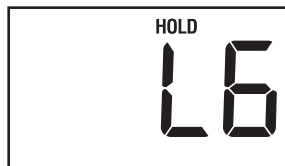

5 Programming User Settings *cont.*

Setting the Filter Check Monitor (see also section 8)

The default setting is 0 days (monitor disabled).

- After pressing the **RETURN** button again, the display will show "FILT XXX SET", where "XXX" is the Filter Monitor interval.
- Press the **▲** or **▼** button to change the Filter Monitor interval to the desired value of 0 (disabled), 30, 60, 90, 120, or 180 days.
- Press the **RETURN** button again to return to normal operating mode or wait 30 seconds for the thermostat to return to normal operating mode automatically.



6 Setting Your Energy Saving Programs

Tips Before Starting

NOTE: If the thermostat is in the non-programmable mode you cannot set an Energy Savings Program. The System mode, Time, Day and Temperature will still be displayed when the thermostat is in the non-programmable mode.

- It is important for you to set the current time of day (note the AM/PM indicator in the display), and the current day of week correctly to avoid problems with program execution. This must be done prior to entering any program settings.
- The heating and cooling programs have both separate set point times and set point temperatures.
- This thermostat is preprogrammed with weekday and weekend times and temperatures. These settings provide efficient energy savings during normal heating and cooling modes of operation. If you wish to use the settings in the table, no further programming is necessary. Review these time and temperature settings prior to establishing your personal program settings to maximize your savings, and minimize programming requirements.

Setting Your Energy Saving Programs—Tips Before Starting

	Weekday	Weekend
MORN	Time: 6:00 am Heat: 70° F (21° C) Cool: 75° F (24° C)	Time: 6:00 am Heat: 70° F (21° C) Cool: 75° F (24° C)
DAY	Time: 8:00 am Heat: 62° F (17° C) Cool: 83° F (28° C)	Time: 8:00 am Heat: 70° F (21° C) Cool: 75° F (24° C)
EVE	Time: 6:00 pm Heat: 70° F (21° C) Cool: 75° F (24° C)	Time: 6:00 pm Heat: 70° F (21° C) Cool: 75° F (24° C)
NIGHT	Time: 10:00 pm Heat: 62° F (17° C) Cool: 78° F (26° C)	Time: 10:00 pm Heat: 62° F (17° C) Cool: 78° F (26° C)

NOTE: If the 7 day programming mode was selected during the Installer Setup (section 3), the default program will use the weekday times and temperatures shown above for all 7 days. The programming mode can be switched between weekday-weekend and 7 day at any time by programming the Installer Options (see section 3).

- Make sure you place the system switch in the **HEAT** or **COOL** modes of operation as appropriate. You should not enter a program in the **OFF** or **EMER** position.
- When you place the system switch in the **COOL** or **HEAT** modes of operation, the appropriate indicator will also appear in the LCD display when the system is running.
- When you place the system switch in the **OFF** mode the display will indicate **OFF**.

Programming Overview For 7 Day Programming Mode

The 7 Day mode has separate Whole Week or Individual Day programming to allow you to change the daily set point times and temperatures to meet your individual schedule needs. The Whole Week programming can be used to set the main portion of your schedule, allowing you to later modify specific days of the week as required using the Individual Day programming capabilities.

Whole Week - allows you to program all seven days (M, TU, W, TH, F, SA, SU will show in display) at the same time. Then you can use individual day programming to fine tune your program for the few set point times or temperatures that you may wish to change.

Individual Days - allows you to program each day of the week individually to give you the greatest schedule flexibility. Often used to fine tune programming after initially programming.

IMPORTANT NOTE! When in Whole Week programming, the thermostat will check if all of the days of that group have the same program set point times and temperatures. If so, the set point time and temperature of the individual set point will be displayed. Otherwise, the individual set point time and temperature will be blanked. The user is allowed to change the daily programs for this set point time and temperature by pressing the **▲** or **▼** button. This will reset all the daily programs of the group for that specific individual set point time and temperature to the startup default for that set point. Continued pressing of the **▲** or **▼** button by the user will change set point time and temperature settings as desired.

Entering Your Program – Weekday / Weekend Mode (5-2 Day)

1. Place the system switch in the **HEAT** mode of operation.
2. Press the **PROG** button to enter the Program setting mode. The **MORN** set point of the Whole Week Program Group will be displayed. The display will show **M, TU, W, TH, F, SA, SU** to indicate the whole week is being programmed. The hour portion of the set point time and the **AM/PM** indicator will be flashing.
3. If you wish to program each day individually press the **DAY/TIME** button to select each day.
4. Press the **▲** or **▼** button to change the time to the desired hour in one hour increments. Press **PROG** button, the minute portion of the set point time will begin flashing.
5. Press the **▲** or **▼** button to change the time to the desired minute in 10-minute increments, press the **PROG** button. The temperature digits will begin flashing.
6. Press the **▲** or **▼** button to change the set point temperature to the desired setting in 1° F increments (0.5° C). Press the **PROG** button.
7. Follow steps 4 through 6 to set the set point times and temperatures for the **DAY, EVE** and **NIGHT** for the **HEAT** mode.
8. Place the system switch in the **COOL** mode of operation. The display will show **COOL**. Follow steps 2 through 6 to set the set point times and temperatures for the **COOL** mode.
9. After completion of programming, wait 30 seconds or press **RETURN** to return to the normal mode.

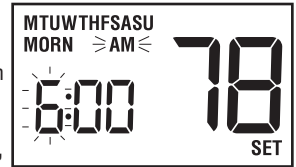

Programming Overview For Weekday/Weekend Programming Mode (5-2 Day)

Your thermostat contains separate Weekday and Weekend Program Groups that allow you to change the daily set point times and temperatures to meet your individual schedule needs.

Weekday - allows you to program all the weekdays (M, TU, W, TH, F will show in display) at the same time. Allows programming times and temperature settings for four set points (MORN, DAY, EVE, and NIGHT) to meet your daily weekday schedule needs.

Weekend - allows you to program all the weekend days (SA, SU will show in display) at the same time. Again, allows programming times and temperature settings for four set points (MORN, DAY, EVE, and NIGHT) to meet your daily Weekend schedule needs. (Continued on page 12)

6 Setting Your Energy Saving Programs *cont.*

Entering Your Program

1. Place the system switch in the **HEAT** mode of operation.
2. Press the **PROG** button to enter Program setting mode. The **MORN** set point of the Weekday Program Group will be displayed. The display will show **M, TU, W, TH, F** to indicate the Weekday group is being programmed. The hour portion of the set point time and the **AM/PM** indicator will be flashing.
3. Press the **▲** or **▼** button to change the time to the desired hour in one hour increments. Press the **PROG** button. The minute portion of the set point time will begin flashing.
4. Press the **▲** or **▼** button to change the time to the desired minute in 10-minute increments. Press the **PROG** button to save. The temperature digits will begin flashing.
5. Press the **▲** or **▼** button to change the set point temperature to the desired setting in 1° F. increments (0.5° C). Press the **PROG** button. The thermostat will now display the **DAY** set point time and temperature. Again, you will see the hour portion of the set point time and the **AM/PM** indicator will be flashing.
6. Follow steps 3 through 5 to set the set point times and temperatures for the periods of **DAY, EVE** and **NIGHT**.
7. After pressing the **PROG** button, you will enter the Weekend Program Group. The display will show **SA, SU** to indicate the Weekend group is being programmed. The hour portion of the **MORN** set point time and the **AM/PM** indicator will be flashing.
8. Follow steps 3 through 6 to set the set point times and temperatures for the periods of **MORN, DAY, EVE** and **NIGHT**.
9. Place the system switch in the **COOL** mode of operation. The display will show **COOL**. Follow steps 2 through 8 to program the set point times and temperatures for the Weekday and Weekend groups in the **COOL** mode.

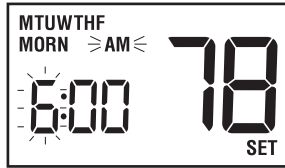

7 Temperature Adjustment *cont.*

Temporary Program Override

1. Press and hold **▲** or **▼** button for 1 second or longer. The entire display will flash once and the **SET** indicator will be displayed. Release the **▲** or **▼** button and press the **▲** or **▼** button again as desired to adjust the set temperature.
2. The display will return to normal operating mode after 15 seconds or you can press the **RETURN** button.
3. The program indicator (**MORN, DAY, EVE** or **NIGHT**) will be flashing in the display, indicating that a Temporary Program Override is in effect. The Temporary Program Override will reset when the next set point time occurs or after four hours—whichever comes first.

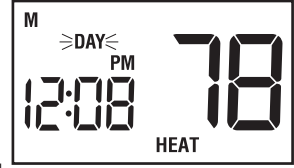

Extended Hold (Vacation) Mode

1. Press the **HOLD** button to bypass the program schedule. The current set point temperature will be held either permanently or for 24 hours, depending on the setting selection made in section 4.
2. Press the **HOLD** button again to return the thermostat to the normal program operation.
3. The hold period will last until the hold is released as in step number 2 above, or is limited to 24 hours if the default was changed in the User Options Settings (see section 4).

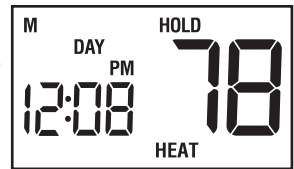

NOTE: *Extended Hold Mode is not available if the thermostat is in the non-programmable mode. If the non-programmable mode is selected and **HOLD** is pressed, **NO** will be displayed as long as the key is held.*



7 Temperature Adjustment

Review Set Temperature

1. Press and hold the **▲** or **▼** button. The current set point temperature will be displayed in place of the current room temperature, and the indicator **SET** will be displayed.
2. The display will return to normal operating mode when the **▲** or **▼** button is released. Continuing to hold the **▲** or **▼** button for 1 second or longer will allow the user to temporarily override the current programmed set point.

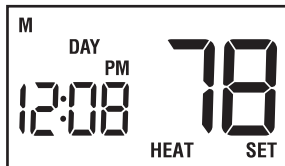

8 Additional Operation Features

Filter Check Monitor (see section 5 For setting)

The Filter Check Monitor displays a reminder for required filter replacement or cleaning by flashing the **FILT** segment in the display. See instructions on your filter or heating/cooling unit for recommendations for interval setting. When the selected interval has been reached, and required cleaning or replacement has been performed, press the **RETURN** button in any normal mode to reset the timer and turn off the warning.

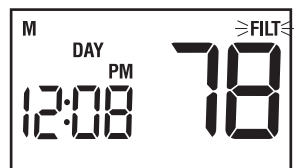

Low Battery Detection

This thermostat requires two (2) new, properly installed “AA” Alkaline batteries to maintain the system clock and to provide proper thermostat power when 24 volt AC power fails or is not connected to the thermostat. When the batteries start to become too weak to provide proper operation, the thermostat will begin to display a low battery indicator.



The low battery indicator is provided to inform the user when the batteries require immediate attention. We recommend replacing the batteries as soon as the low battery indicator appears. If the batteries are not replaced after the low battery indicator first appears, the thermostat may not provide proper heating or cooling system operation.

Even if the low battery indicator does not appear, the batteries should be replaced at least once a year, or if you plan on leaving the premises for over a month.

This thermostat can be powered from 24 volts AC or battery power. To determine if 24 volt AC power is connected to the thermostat, refer to the installation and wiring diagram section. If you cannot determine how this thermostat is powered, call a professional service technician to determine the type of installation and the proper operation of your system.

Locking the Keypad

To prevent accidental or undesired adjustment of the thermostat, the Keypad Lock feature disables the operation of the keypad except for the backlight key. In order to lock the keypad, press and hold Both **▲** and **▼** buttons together at the same time for 5 seconds. The **LOCK** segment in the display will flash once per second. When **LOCK** appears continuously, release both **▲** and **▼** buttons. The keypad is now locked.

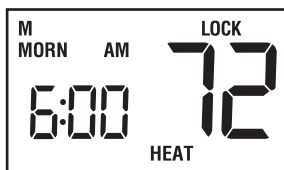

To unlock the keypad, press and hold the **▲** and **▼** buttons together at the same time for 1 second. The **LOCK** segment will disappear and the keypad will become unlocked.

Adaptive Recovery Mode (ARM™)

In order to maximize comfort and energy efficiency, this thermostat is equipped with an Adaptive Recovery Mode (ARM™). This feature minimizes the amount of time required by heating or cooling system to reach the new set point after a setback period is completed, and assures your desired temperature is achieved at your set program times. This feature activates when recovering room temperature from setback programs to comfort programs, so it will only take place when the current (heating) program set point temperature is lower than the upcoming program set point temperature, or the current (cooling) program set point temperature is higher than the upcoming program set point temperature. During ARM™, room temperature is recovered gradually by turning on the heating or cooling before the end of the setback period. ARM™ does not operate when the unit is in the HOLD mode, if the program is temporarily overridden, or if it has been disabled in the Installer Settings.

Circulating Fan Mode—Fan Operation

AUTO: Fan operates as required by heating or cooling system.

⌚: When heating or cooling is not active, fan will run as needed to ensure a 35% minimum run time.

ON: Fan will run at all times.

Auxiliary Heat Fossil Fuel Option

This thermostat is equipped with an auxiliary heat option which is set at installation for either an electric or fossil fuel (gas, oil or propane) auxiliary heat source. For heat pump units with an electric auxiliary stage, both the first and second stages of heating will run when a call for second stage heat is made. For heat pump units with a fossil fuel auxiliary stage, the first stage will be locked out one minute after a second stage heat call, and the second stage alone will be used.

Compressor Protection

This thermostat includes an automatic compressor protection feature to avoid potential damage to the cooling system from short cycling. This thermostat automatically provides a 5-minute delay after turning off the cooling system output to protect the compressor. This protection is also present in the heat mode of operation on heat pump systems to protect the compressor. This delay can be disabled in installer Option 8 (see section 3).

NOTE: *The installer can reset the thermostat and bypass the compressor protection features by pressing the **RESET** button. This will erase all entered programs, current time of day, day of week and other user settings and should only be used during installation for testing purposes or to reset a thermostat to regain normal operation. This will return all thermostat settings to their default values. The user will have to reprogram all of the erased settings.*

8 Additional Operation Features *cont.*

This thermostat provides one type of cold weather compressor protection by locking out the compressor stage (1st Stage) of heating for a period of time after a power outage greater than 60 minutes. The lockout period is one hour less than the outage time, up to a maximum of 12 hours. During that period of time, the auxiliary heat stage will still be available to maintain the set point temperature. The compressor lockout can be manually overridden at any time by moving the system switch to the OFF position momentarily, then back to the heat position. We still recommend using a separate outdoor thermostat for proper cold weather protection.

AC Power Interrupt Warning

During a power loss, the thermostat will display an outage warning. The system clock will continue to run, and all settings will be maintained until the outage period is over. (This feature needs to be enabled - see section 3)

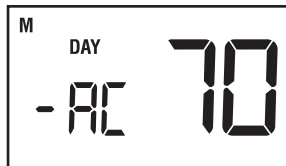

Status Indicators

HEAT: This will turn on whenever the system switch is in the HEAT mode. "HEAT" will flash when the heating system is running.

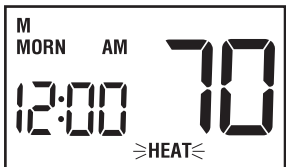

COOL: This will turn on whenever the system switch is in the cool mode. "COOL" will flash when the cooling system is running.



EM HEAT: This will turn on whenever the system switch is in the EMER (Emergency Heat) mode.

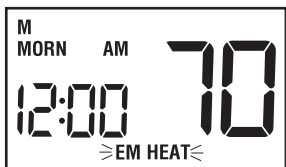

AUX: This will turn on when the auxiliary second stage of heating or cooling is active. The auxiliary stage of heating is usually the least economical stage of heat.

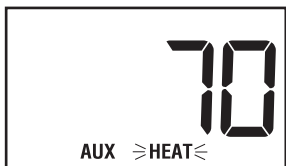

CHECK: Indicator will be displayed when a malfunction occurs in the heat pump system. When CHECK is displayed, call a professional service technician to verify system performance and switch the system to Emergency Heat mode if required to maintain room temperature.



9 Battery Replacement

Replacing the Batteries

1. Open the front cover and locate the battery compartment door.
2. Gently remove the two "AA" alkaline batteries located in the battery compartment.
3. Install two new "AA" alkaline batteries into battery compartment. Make sure to match the positive (+) ends of the batteries with the positive (+) terminals located in the battery compartment.
4. Close battery compartment and verify that the low battery indicator does not appear in the display.

10 Troubleshooting

Symptom: *The word HEAT or COOL is flashing in the thermostat display.*

Potential Solution: This indicates that the heating or cooling system is currently running. When these systems are not running, HEAT or COOL will not flash.

Symptom: *HEAT or COOL is flashing but the system is not running.*

Potential Solution: The thermostat is telling the heating or cooling system to run, but the system is not responding. You may need to call your local heating and air conditioning contractor.

Symptom: *Thermostat does not turn on heating or cooling system.*

Potential Solutions: Check to see if **OFF** is shown in display. This indicates that the system is turned off at the thermostat. Move the system selector switch to the **HEAT** or **COOL** position. After the compressor short cycle protection 5-minute period expires, the system should start within a minute's time.

Compressor protection features may be in effect due to compressor short cycle conditions, power outages or rolling blackouts. See Compressor Protection and AC Power Monitor on page 15 for a full explanation of this feature.

Heat pump may be malfunctioning. Review the **CHECK** status indicator in the display. If the **CHECK** status indicator appears, call a professional service technician to confirm heat pump operation and provide necessary service. If heating is required you can slide the system switch to **EMER** setting which should start the Emergency Heat source to provide heating until the heat pump can be serviced.

Symptom: *Thermostat turns on heating instead of cooling, or cooling instead of heating.*

Potential Solution: Check thermostat wiring to make sure that the heating and cooling stages are connected to the correct terminals on the wiring terminal block (see section 11).

Symptom: *Fan runs intermittently or when system is off.*

Potential Solution: This is normal operation when the fan switch is in circulate (🌀) mode.

Symptom: *Thermostat will not follow program set points.*

Potential Solutions: Check current time of day, day of week program settings. Make sure to verify **AM/PM** indicator is accurately displaying desired time settings. See section 6. (*Potential Solutions continued on page 18*)

10 Troubleshooting *cont.*

Check to see if **OFF** is shown in display. This indicates that the system is turned off at the thermostat. Move the system selector switch to the **HEAT** or **COOL** position. After the compressor short cycle protection 5-minute period expires, the system should start within several seconds.

Verify your program set point time entries. The heating and cooling programs utilize individual set point temperatures and set point times for the **MORN**, **DAY**, **EVE** and **NIGHT** set points. See section 6.

Thermostat program has been temporarily overridden and program indicator is flashing in the display. Wait till next set point and the temporary override will expire or change set point temperature to desired comfort level.

Thermostat program is in Extended Hold (Vacation) Mode and **HOLD** is showing in display. Press **HOLD** button to release permanent hold and return the thermostat to normal program operation.

Symptom: *Thermostat turns heating or cooling system on too often or not often enough.*

Potential Solution: Increase or decrease first stage temperature differential setting as appropriate to provide the desired performance level (see section 6).

Symptom: *Thermostat turns on second (auxiliary) stage of heating or cooling too quickly or not quickly enough.*

Potential Solution: Increase or decrease second (auxiliary) stage temperature differential setting as appropriate to provide the desired performance level. See section 5, Second Stage Differential.

Symptom: *Low battery indicator is shown in thermostat display.*

Potential Solution: Replace back-up batteries as soon as possible to maintain proper system operation. See section 6, Low Battery Detection and Replacement.

Symptom: *OFF is shown in thermostat display and heating or cooling system will not start.*

Potential Solution: This indicates that the system is turned off at the thermostat. Move the system selector switch to **HEAT** or **COOL** position. After the compressor short cycle protection 5-minute period expires, the system should start within several seconds.

Symptom: *The room is too warm or too cold.*

Potential Solution: Press the **▲** or **▼** button for 1 second to verify the set point. Raise or lower temperature as required. Ensure system switch is in **HEAT** or **COOL** position.

Symptom: *Thermostat display is blank or reads -AC*

Potential Solution: It is possible that AC power is not present at the thermostat and the batteries are drained. Check fuse, circuit breaker and thermostat wiring as appropriate to verify AC power is available. Replace batteries before reprogramming thermostat. (see section 9). If AC power is present, call a professional service technician to verify thermostat and system performance.

Symptom: *Cannot program a set point temperature higher than 90° F (32° C).*

Potential Solution: This is above the normal thermostat temperature setting range of 45° to 90° F (7° to 32° C).

10 Troubleshooting *cont.*

Symptom: *HI is shown in the thermostat display where the room temperature is normally displayed.*

Potential Solutions: The temperature sensed by the thermostat is higher than the 99° F (37° C) upper limit of the thermostat's display range. The display will return to normal after the sensed temperature lowers within the 40° to 99° F (5° to 37° C) display range. Turn on the cooling system or use other methods to lower the temperature accordingly.

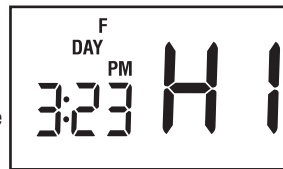

Symptom: *LO is shown in the thermostat display where the room temperature is normally displayed.*

Potential Solutions: The temperature sensed by the thermostat is lower than the 40° F (4° C) lower limit of the thermostat's display range. The display will return to normal after the sensed temperature rises within the 40° to 99° F (4° to 37° C) display range. Turn on the heating system to raise the temperature as needed for comfort within the room.

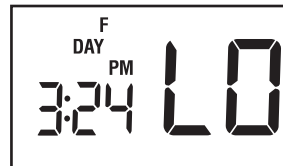

Symptom: *Thermostat will not allow me to change the set point.*

Potential Solution: The Keypad is locked. Press both the **▲** and **▼** key together at the same time for one second to unlock (see section 5).

Symptom: *Fan continues to run all the time whether the system is on or off.*

Potential Solutions: Check that the fan control switch is in the **AUTO** position. This will allow the fan to run only when the heating or cooling system is turned on and running.

Check thermostat wiring to make sure that the fan control wiring is connected to the correct terminals on the wiring terminal block (see section 11).

Symptom: *Fan continues to run in cooling mode when the system has turned off.*

Potential Solution: The Residual Cooling Fan Control Feature can allow up to a 90 second fan delay after cooling system shutdown for energy efficiency gains. The default setting is 60 seconds. This can be changed to disable this feature or shorten the time period if desired (see section 5).

Symptom: *The thermostat does not allow me to program each day separately.*

Potential Solution: Thermostat must be in 7 Day mode for separate day to day programming.

Symptom: *System turns on prior to the end of a setback period.*

Potential Solution: Thermostat is in Adaptive Recovery Mode (see section 6).

Symptom: *NO EM HEAT SET is shown in the thermostat display.*

Potential Solution: The thermostat is configured for a conventional system, and the system switch is in the **EM HEAT** position. The unit will still function in a conventional 2 stage **HEAT** mode, but the display will flash **NO EM HEAT SET**. Move the system switch to the **HEAT** position.

Premier Series Programmable Thermostats

Conventional Systems

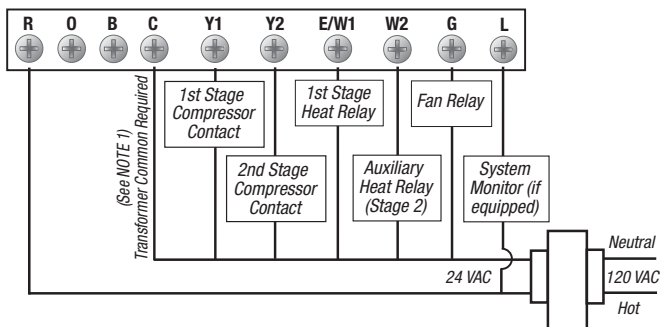

NOTE: 1. Transformer Common connection not required for battery-only operation of thermostat. 2. Eliminate connection to Y2 for units with single stage cooling.

Heat Pump Systems

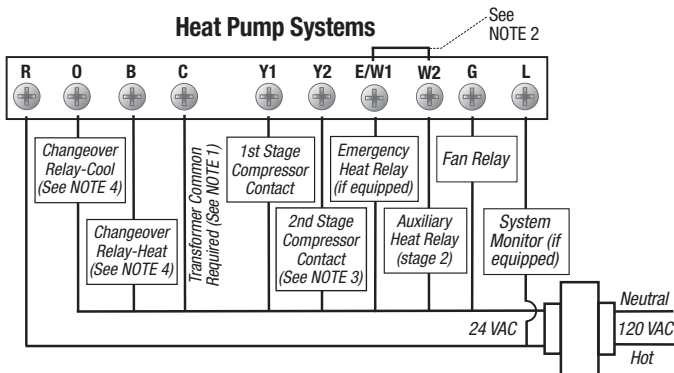

NOTE: 1. Transformer Common connection not required for battery-only operation of thermostat. 2. User installed jumper is required to use auxiliary heat for both second stage and emergency heat on units without separate emergency heat and auxiliary terminals. DO NOT install jumper if both terminals are present. 3. Eliminate connection to Y2 for units with single stage cooling. 4. For units requiring reversing valve to be energized during heating, connect reversing valve to B terminal. For units requiring reversing valve to be energized during cooling, connect reversing valve to O terminal.

LIMITED WARRANTY

Braeburn Systems LLC warrants each new Braeburn thermostat against any defects that are due to faulty material or workmanship for a period of five years after the original date of purchase by a professional service technician. This warranty and our liability does not apply to batteries, nor does it include damage to merchandise or the thermostat resulting from accident, alteration, neglect, misuse, improper installation or any other failure to follow Braeburn installation and operating instructions.

Braeburn Systems LLC agrees to repair or replace at its option any Braeburn thermostat under warranty provided it is returned postage prepaid to our warranty facility in a padded carton within the warranty period, with proof of the original date of purchase and a brief description of the malfunction. This limited warranty does not include the cost of removal or re-installation.

This warranty gives you specific legal rights and you may also have other rights that vary from state to state or province to province. Answers to any questions regarding our limited warranty may be obtained by writing our corporate offices.

WARRANTY FACILITY: Braeburn Systems LLC
Attn: Warranty Department
2215 Cornell Avenue
Montgomery, IL 60538



Store this manual for future reference.

Braeburn®

Braeburn Systems LLC
2215 Cornell Avenue • Montgomery, IL 60538
Technical Assistance: www.braeburnonline.com
Call us toll-free: 866-268-5599 (U.S.)
630-844-1968 (Outside the U.S.)