

HEAT PUMP UNIT

AVZC18 HEAT PUMP INSTALLATION & SERVICE REFERENCE



Index

IMPORTANT SAFETY INSTRUCTIONS	1
SHIPPING INSPECTION	1
CODES & REGULATIONS	2
FEATURES	2
INSTALLATION CLEARANCES	2
ROOFTOP INSTALLATIONS	2
SAFE REFRIGERANT HANDLING	3
REFRIGERANT LINES	3
REFRIGERANT LINE CONNECTIONS	5
LEAK TESTING (NITROGEN OR NITROGEN-TRACED)	5
SYSTEM START-UP PROCEDURE	5
ELECTRICAL CONNECTIONS	6
HEAT PUMP ADVANCED FEATURE MENU	22
WIRING DIAGRAM [2-5 TON]	25
CAPACITOR	26
TROUBLESHOOTING	30
SETTING THE MODE DISPLAY	35
7-SEGMENT DISPLAY	41
START UP CHECKLIST	45

IMPORTANT SAFETY INSTRUCTIONS

The following symbols and labels are used throughout this manual to indicate immediate or potential safety hazards. It is the owner's and installer's responsibility to read and comply with all safety information and instructions accompanying these symbols. Failure to heed safety information increases the risk of personal injury, property damage, and/or product damage.

⚠ WARNING

HIGH VOLTAGE !
DISCONNECT ALL POWER BEFORE SERVICING.
MULTIPLE POWER SOURCES MAY BE PRESENT. FAILURE TO DO SO MAY CAUSE PROPERTY DAMAGE, PERSONAL INJURY OR DEATH.



⚠ WARNING

ONLY PERSONNEL THAT HAVE BEEN TRAINED TO INSTALL, ADJUST, SERVICE OR REPAIR (HEREINAFTER, "SERVICE") THE EQUIPMENT SPECIFIED IN THIS MANUAL SHOULD SERVICE THE EQUIPMENT. THE MANUFACTURER WILL NOT BE RESPONSIBLE FOR ANY INJURY OR PROPERTY DAMAGE ARISING FROM IMPROPER SERVICE OR SERVICE PROCEDURES. IF YOU SERVICE THIS UNIT, YOU ASSUME RESPONSIBILITY FOR ANY INJURY OR PROPERTY DAMAGE WHICH MAY RESULT. IN ADDITION, IN JURISDICTIONS THAT REQUIRE ONE OR MORE LICENSES TO SERVICE THE EQUIPMENT SPECIFIED IN THIS MANUAL, ONLY LICENSED PERSONNEL SHOULD SERVICE THE EQUIPMENT. IMPROPER INSTALLATION, ADJUSTMENT, SERVICING OR REPAIR OF THE EQUIPMENT SPECIFIED IN THIS MANUAL, OR ATTEMPTING TO INSTALL, ADJUST, SERVICE OR REPAIR THE EQUIPMENT SPECIFIED IN THIS MANUAL WITHOUT PROPER TRAINING MAY RESULT IN PRODUCT DAMAGE, PROPERTY DAMAGE, PERSONAL INJURY OR DEATH.

⚠ CAUTION

THE UNIT HAS ITS OWN PUMP-DOWN MODE. USE THE PUMP-DOWN MODE WHILE VACUUMING THE UNIT. VACUUMING TOO LOW CAN CAUSE INTERNAL ELECTRICAL ARCING, RESULTING IN A DAMAGED OR FAILED COMPRESSOR.

SHIPPING INSPECTION

Always keep the unit upright; laying the unit on its side or top may cause equipment damage. Shipping damage, and subsequent investigation is the responsibility of the carrier. Verify the model number, specifications, electrical characteristics, and accessories are correct prior to installation. The distributor or manufacturer will not accept claims from dealers for transportation damage or installation of incorrectly shipped units.



CODES & REGULATIONS

This product is designed and manufactured to comply with national codes. Installation in accordance with such codes and/or prevailing local codes/regulations is the responsibility of the installer. The manufacturer assumes no responsibility for equipment installed in violation of any codes or regulations. Rated performance is achieved after 72 hours of operation. Rated performance is delivered at the specified airflow. See outdoor unit specification sheet for split system models or product specification sheet for packaged and light commercial models. Specification sheets can be found at www.amana-hac.com for Amana® brand products. Within the website, please select the residential or commercial products menu and then select the submenu for the type of product to be installed, such as air conditioners or heat pumps, to access a list of product pages that each contain links to that model's specification sheet.

The United States Environmental Protection Agency (EPA) has issued various regulations regarding the introduction and disposal of refrigerants. Failure to follow these regulations may harm the environment and can lead to the imposition of substantial fines. Should you have any questions please contact the local office of the EPA.

If replacing a condensing unit, heat pump or air handler, the system must be manufacturer approved and Air Conditioning, Heating and Refrigeration Institute (AHRI) matched.

NOTE: The installation of an inverter heat pump with unmatched system units will not allow for proper operation.

NOTICE

INVERTER H/P MODELS CAN ONLY BE MATCHED WITH AN AVPEC AIR HANDLER. DAMAGE RESULTING FROM OPERATION WITH ANY OTHER COMBINATION IS NOT COVERED BY OUR WARRANTIES.**

Outdoor inverter units are approved for operation above 0°F in cooling mode and -20°F (RH10%) in heating mode with no additional kit necessary.

Damage resulting from operation of the unit in a structure that is not complete (either as part of new construction or renovation) is not covered by our warranties.

FEATURES

This heat pump is part of a system that uses inverter technology to more efficiently remove or add heat with better efficiency and achieve the target comfort conditions. System may ONLY be installed using a ComfortNet™ thermostat with model number CTK04 as part of the digital communicating system. The ComfortNet system reduces the number of required thermostat wires, provides additional setup features and enhanced active diagnostics. Due to components using inverter technology, the heat pump will not function properly if used with a CTK03, 02 or 01 ComfortNet thermostat.

NOTICE

NOT APPROVED FOR USE WITH A CTK01, CTK02 OR CTK03.

INSTALLATION CLEARANCES

Special consideration must be given to location of the heat pump unit(s) in regard to structures, obstructions, other units, and any/all other factors that may interfere with air circulation. Where possible, the top of the unit should be completely unobstructed; however, if vertical conditions require placement beneath an obstruction **there should be a minimum of 60 inches between the top of the unit and the obstruction(s)**. The specified dimensions meet requirements for air circulation only. Consult all appropriate regulatory codes prior to determining final clearances.

Another important consideration in selecting a location for the unit(s) is the angle to obstructions. Either side adjacent the valves can be placed toward the structure provided the side away from the structure maintains minimum service clearance. Corner installations are strongly discouraged.

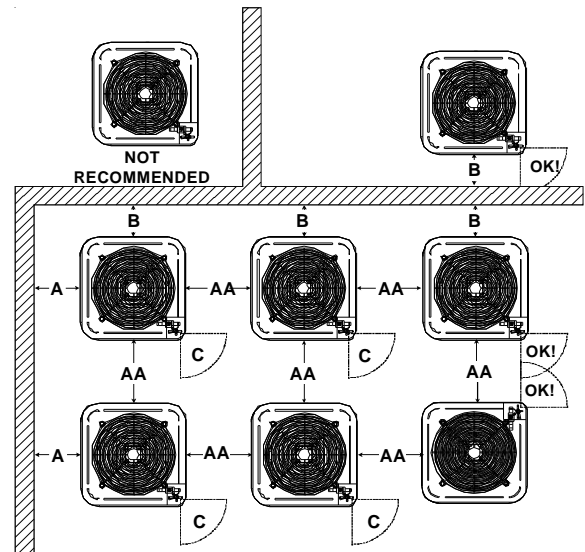

Minimum Airflow Clearance

Model Type	A	B	C	AA
Residential	10"	10"	18"	20"
Light Commercial	12"	12"	18"	24"

This unit can be located at ground floor level or on flat roofs. At ground floor level, the unit must be on a solid, level foundation that will not shift or settle. To reduce the possibility of sound transmission, the foundation slab should not be in contact with or be an integral part of the building foundation. Care should be taken to ensure the unit is installed away from noise sensitive locations such as bedrooms, windows and outdoor living areas. Ensure the foundation is sufficient to support the unit. A concrete slab raised above ground level provides a suitable base.

ROOFTOP INSTALLATIONS

If it is necessary to install this unit on a roof structure, ensure the roof structure can support the weight and that proper consideration is given to the weather-tight integrity of the roof. Since the unit can vibrate during operation, sound vibration transmission should be considered when installing the unit. Vibration absorbing pads or springs can be installed between the heat pump unit legs or frame and the roof mounting assembly to reduce noise vibration.

ELECTRICAL NOISE

The unit should be well grounded so that potential effects of electrical noise from the inverter to surrounding equipment can be minimized.

When selecting an installation location, keep sufficient distance from the heat pump unit and wiring to radios, personal computers, stereos, etc., as shown in the following figure.

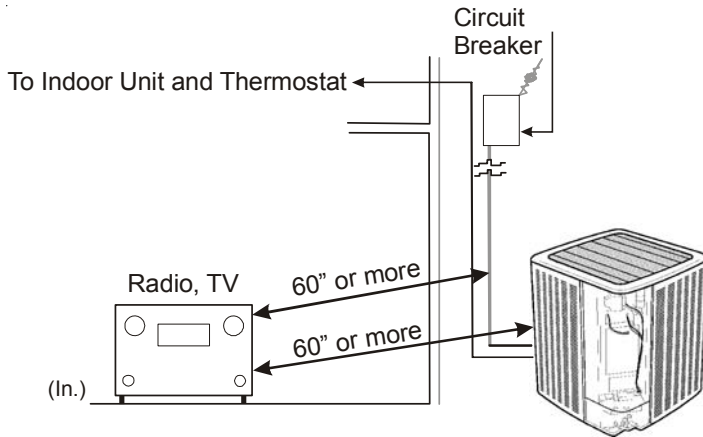

Placement to Minimize Electronic Noise

SAFE REFRIGERANT HANDLING

While these items will not cover every conceivable situation, they should serve as a useful guide.

! WARNING

TO AVOID POSSIBLE EXPLOSION, USE ONLY RETURNABLE (NOT DISPOSABLE) SERVICE CYLINDERS WHEN REMOVING REFRIGERANT FROM A SYSTEM.

- ENSURE THE CYLINDER IS FREE OF DAMAGE WHICH COULD LEAD TO A LEAK OR EXPLOSION.
- ENSURE THE HYDROSTATIC TEST DATE DOES NOT EXCEED 5 YEARS.
- ENSURE THE PRESSURE RATING MEETS OR EXCEEDS 400 PSIG.

WHEN IN DOUBT, DO NOT USE CYLINDER.

! WARNING

REFRIGERANTS ARE HEAVIER THAN AIR. THEY CAN "PUSH OUT" THE OXYGEN IN YOUR LUNGS OR IN ANY ENCLOSED SPACE. TO AVOID POSSIBLE DIFFICULTY IN BREATHING OR DEATH:

- NEVER PURGE REFRIGERANT INTO AN ENCLOSED ROOM OR SPACE. BY LAW, ALL REFRIGERANTS MUST BE RECLAIMED.
- IF AN INDOOR LEAK IS SUSPECTED, THOROUGHLY VENTILATE THE AREA BEFORE BEGINNING WORK.
- LIQUID REFRIGERANT CAN BE VERY COLD. TO AVOID POSSIBLE FROSTBITE OR BLINDNESS, AVOID CONTACT AND WEAR GLOVES AND GOGGLES. IF LIQUID REFRIGERANT DOES CONTACT YOUR SKIN OR EYES, SEEK MEDICAL HELP IMMEDIATELY.
- ALWAYS FOLLOW EPA REGULATIONS. NEVER BURN REFRIGERANT, AS POISONOUS GAS WILL BE PRODUCED.

! WARNING

TO AVOID POSSIBLE INJURY, EXPLOSION OR DEATH, PRACTICE SAFE HANDLING OF REFRIGERANTS.

! WARNING

TO AVOID POSSIBLE EXPLOSION:

- NEVER APPLY FLAME OR STEAM TO A REFRIGERANT CYLINDER. IF YOU MUST HEAT A CYLINDER FOR FASTER CHARGING, PARTIALLY IMMERSE IT IN WARM WATER.
- NEVER FILL A CYLINDER MORE THAN 80% FULL OF LIQUID REFRIGERANT.
- NEVER ADD ANYTHING OTHER THAN R-410A TO A RETURNABLE R-410A CYLINDER. THE SERVICE EQUIPMENT USED MUST BE LISTED OR CERTIFIED FOR THE TYPE OF REFRIGERANT USE.
- STORE CYLINDERS IN A COOL, DRY PLACE. NEVER USE A CYLINDER AS A PLATFORM OR A ROLLER.

REFRIGERANT LINES

! CAUTION

THE COMPRESSOR PVE OIL FOR R-410A UNITS IS EXTREMELY SUSCEPTIBLE TO MOISTURE ABSORPTION AND COULD CAUSE COMPRESSOR FAILURE. DO NOT LEAVE SYSTEM OPEN TO ATMOSPHERE ANY LONGER THAN NECESSARY FOR INSTALLATION.

Use only refrigerant grade (dehydrated and sealed) copper tubing to connect the heat pump unit with the indoor unit. After cutting the tubing, install plugs to keep refrigerant tubing clean and dry prior to and during installation. Tubing should always be cut square keeping ends round and free from burrs. Clean the tubing to prevent contamination. The liquid line must be insulated if more than 50 ft. of liquid line will pass through an area that may reach temperatures of 30 °F or higher than ambient in cooling mode and/or if the temperature inside the conditioned space may reach a temperature lower than ambient in heating mode. Never attach a liquid line to any uninsulated portion of the gas line.

Do NOT let refrigerant lines come in direct contact with plumbing, ductwork, floor joists, wall studs, floors, and walls. When running refrigerant lines through a foundation or wall, openings should allow for sound and vibration absorbing material to be placed or installed between tubing and foundation. Any gap between foundation or wall and refrigerant lines should be filled with a pliable silicon-based caulk, RTV or a vibration damping material. Avoid suspending refrigerant tubing from joists and studs with rigid wire or straps that would come in contact with the tubing. Use an insulated or suspension type hanger. Keep both lines separate and always insulate the gas line.

Insulation is necessary to prevent condensation from forming and dripping from the gas line. Armflex or satisfactory equivalent with 3/8" min. wall thickness is recommended. In severe conditions (hot, high humidity areas) 1/2" insulation may be required. Insulation must be installed in a manner which protects tubing and connections from damage and contamination.

Where possible, drain as much residual compressor oil from existing systems, lines, and traps; pay close attention to low areas where oil may collect. **NOTE:** If changing refrigerant, the indoor coil and metering device must be replaced. Only AV**PEC air handlers are compatible and have been manufacturer approved for use with these models. See unit specifications or AHRI for an approved system match.

RECOMMENDED INTERCONNECTING TUBING (Ft)		
Line Set Length	0 - 125' Equivalent	
Heat Pump Unit (Tons)	Line Type & Line Diameter (In. OD)	
	Suct	Liq
2	3/4	3/8
3	7/8	3/8
4	1 1/8	3/8
5	1 1/8	3/8

Heat Pump BELOW Indoor Coil

Mounting the indoor coil above the heat pump unit will require an inverted loop in the gas line adjacent or near the connection to the indoor coil, for the purpose of creating an oil trap. The top of the loop must be slightly higher than the top of the coil.

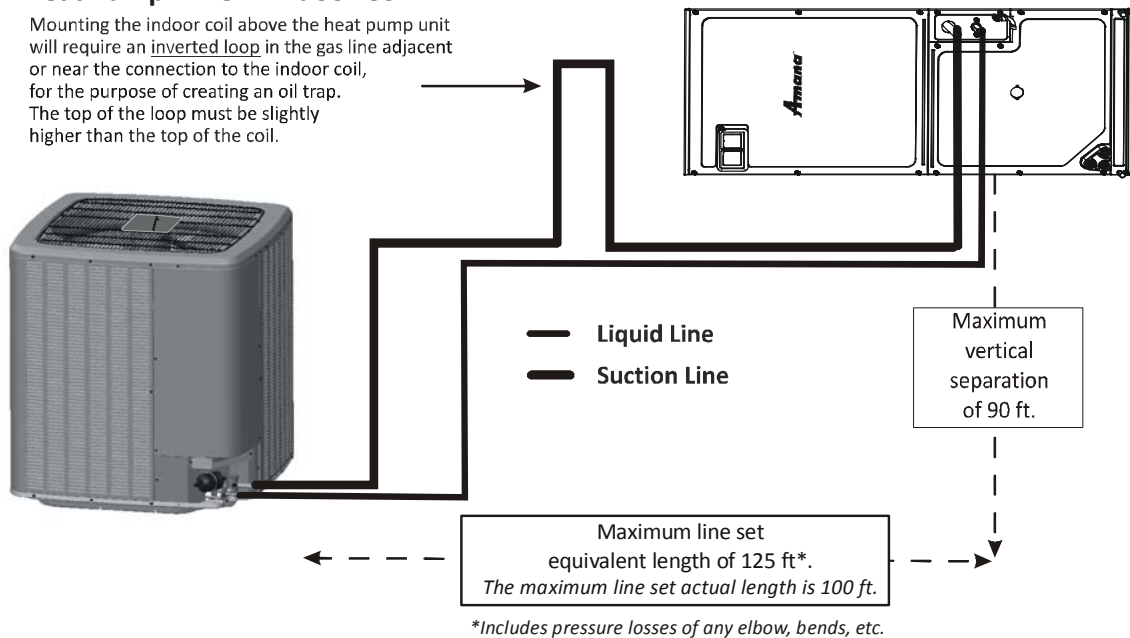

Heat Pump ABOVE Indoor Coil

Mounting the heat pump unit above the indoor coil will require an oil trap that is vertically centered between the heat pump unit and air handler IF the vertical separation exceeds 80 ft. The trap can be constructed from standard refrigerant fittings as shown in the figure (bottom left).

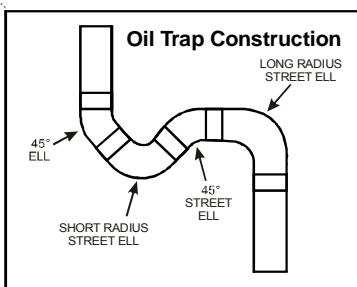
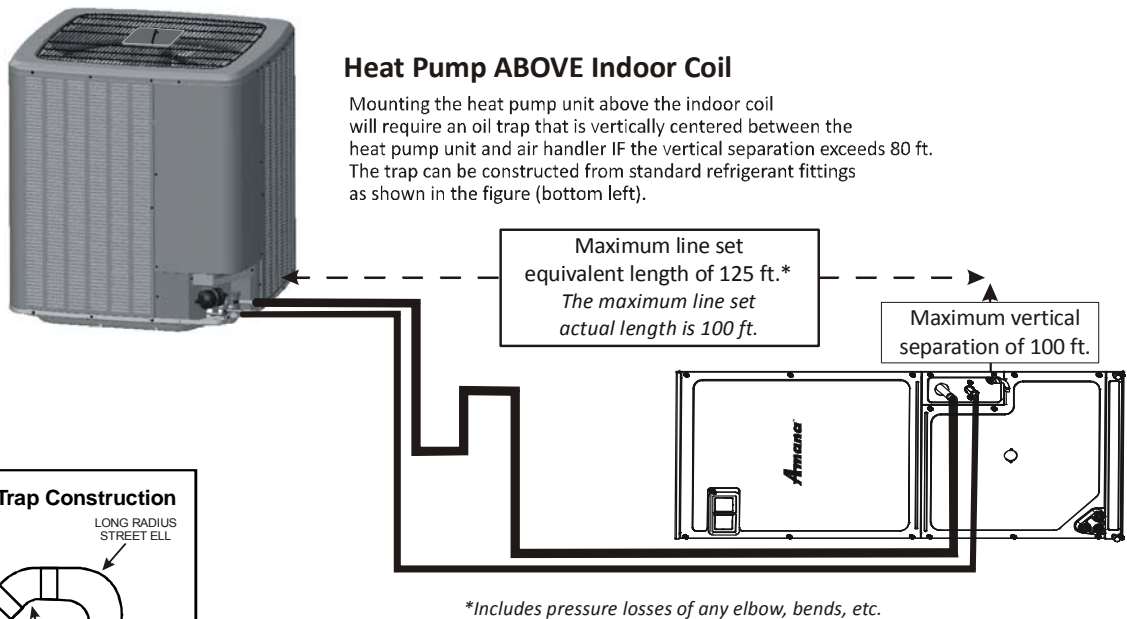

REFRIGERANT LINE CONNECTIONS

IMPORTANT

To avoid overheating the service valve, EEV, or filter drier while brazing, wrap the component with a wet rag, or use a thermal heat trap compound. Be sure to follow the manufacturer's instruction when using the heat trap compound. Note: Remove Schrader valves from service valves before brazing tubes to the valves. Use a brazing alloy of 2% minimum silver content. Do not use flux.

Torch heat required to braze tubes of various sizes is proportional to the size of the tube. Tubes of smaller size require less heat to bring the tube to brazing temperature before adding brazing alloy. Applying too much heat to any tube can melt the tube. Service personnel must use the appropriate heat level for the size of the tube being brazed.

NOTE: The use of a heat shield when brazing is recommended to avoid burning the serial plate or the finish on the unit.

1. The ends of the refrigerant lines must be cut square, deburred, cleaned, and be round and free from nicks or dents. Any other condition increases the chance of a refrigerant leak.
2. "Sweep" the refrigerant line with nitrogen or inert gas during brazing to prevent the formation of copper-oxide inside the refrigerant lines. The PVE oils used in R-410A applications will clean any copper-oxide present from the inside of the refrigerant lines and spread it throughout the system. This may cause a blockage or failure of the metering device.
3. After brazing, quench the joints with water or a wet cloth to prevent overheating of the service valve.
4. A bi-flow filter drier is shipped with the unit as a separate component and must be brazed on by the installer on-site. Ensure the bi-flow filter drier paint finish is intact after brazing. If the paint of the steel filter drier has been burned or chipped, repaint or treat with a rust preventative.
The recommended location of the filter drier is before the expansion device at the indoor unit.

NOTE: Be careful not to kink or dent refrigerant lines. Kinked or dented lines will cause poor performance or compressor damage.

Do **NOT** make final refrigerant line connection until plugs are removed from refrigerant tubing.

LEAK TESTING (NITROGEN OR NITROGEN-TRACED)



WARNING

TO AVOID THE RISK OF FIRE OR EXPLOSION, NEVER USE OXYGEN, HIGH PRESSURE AIR OR FLAMMABLE GASES FOR LEAK TESTING OF A REFRIGERATION SYSTEM.



WARNING

TO AVOID POSSIBLE EXPLOSION, THE LINE FROM THE NITROGEN CYLINDER MUST INCLUDE A PRESSURE REGULATOR AND A PRESSURE RELIEF VALVE. THE PRESSURE RELIEF VALVE MUST BE SET TO OPEN AT NO MORE THAN 150 PSIG.

To locate leaks, pressure test the system using dry nitrogen or leak detector fluid per the manufacturer's recommendation. If you wish to use a leak detector, charge the system to 10 psi using the appropriate refrigerant then use nitrogen to finish charging the system to working pressure then apply the detector to suspect areas. If leaks are found, repair them. After repair, repeat the pressure test. If no leaks exist, proceed to **System Start-up Procedure**.

SYSTEM START-UP PROCEDURE

GENERAL NOTES:

Adequate refrigerant charge for the matching indoor coil and 15 feet of line set is supplied with the heat pump unit. If liquid line set exceeds 15 feet in length, refrigerant should be added at 0.6 ounces per foot of liquid line.

NOTICE

VIOLATION OF EPA REGULATIONS MAY RESULT IN FINES OR OTHER PENALTIES.

NOTICE

ALL UNITS SHOULD HAVE A HIGH VOLTAGE POWER SUPPLY CONNECTED 2 HOURS PRIOR TO STARTUP.



WARNING

REFRIGERANT UNDER PRESSURE!

- DO NOT OVERCHARGE SYSTEM WITH REFRIGERANT.
 - DO NOT OPERATE UNIT IN A VACUUM OR AT NEGATIVE PRESSURE.
- FAILURE TO FOLLOW PROPER PROCEDURES MAY CAUSE PROPERTY DAMAGE, PERSONAL INJURY OR DEATH.



CAUTION

OPERATING THE COMPRESSOR WITH THE GAS VALVE CLOSED WILL CAUSE SERIOUS COMPRESSOR DAMAGE - SUCH DAMAGE IS NOT COVERED BY OUR WARRANTIES.



CAUTION

USE REFRIGERANT CERTIFIED TO AHRI STANDARDS. USED REFRIGERANT MAY CAUSE COMPRESSOR DAMAGE, AND IS NOT COVERED UNDER THE WARRANTY. MOST PORTABLE MACHINES CANNOT CLEAN USED REFRIGERANT TO MEET AHRI STANDARDS.

START-UP PROCEDURE DETAIL

Liquid and gas valves on heat pump unit are closed to contain the charge within the unit. The unit is shipped with the valve stems closed and caps installed. **Do not open valves until the indoor coil and line set is evacuated.**

CAUTION

PROLONGED OPERATION AT SUCTION PRESSURES LESS THAN 20 PSIG FOR MORE THAN 5 SECONDS WILL RESULT IN OVERHEATING OF THE COMPRESSOR AND MAY CAUSE PERMANENT DAMAGE TO IT.

1. Connect the vacuum pump with 250 micron capability to the service valves.
2. Evacuate the system to 250 microns or less using gas and liquid service valves. Using both valves is necessary as some compressors create a mechanical seal separating the sides of the system.
3. Close pump valve and hold vacuum for 10 minutes. Typically pressure will rise during this period.
 - If the pressure rises to 1000 microns or less and remains steady the system is considered leak-free; proceed to start-up.
 - If pressure rises above 1000 microns but holds steady below 2000 microns, moisture and/or noncondensibles may be present or the system may have a small leak. Return to step 2: If the same result is encountered check for leaks as previously indicated and repair as necessary then repeat evacuation.
 - If pressure rises above 2000 microns, a leak is present. Check for leaks as previously indicated and repair as necessary then repeat evacuation.

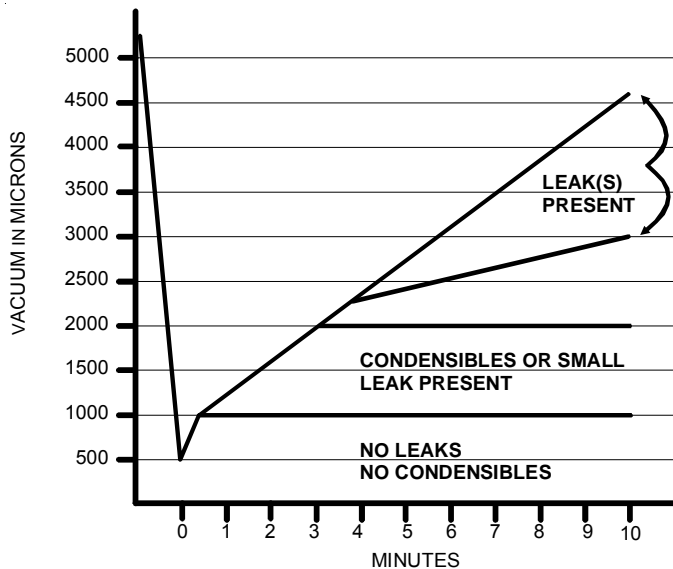

ELECTRICAL CONNECTIONS

WARNING

HIGH VOLTAGE!

DISCONNECT ALL POWER BEFORE SERVICING. MULTIPLE POWER SOURCES MAY BE PRESENT. FAILURE TO DO SO MAY CAUSE PROPERTY DAMAGE, PERSONAL INJURY OR DEATH DUE TO ELECTRIC SHOCK. WIRING MUST CONFORM WITH NEC OR CEC AND ALL LOCAL CODES. UNDERSIZED WIRES COULD CAUSE POOR EQUIPMENT PERFORMANCE, EQUIPMENT DAMAGE OR FIRE.



WARNING

TO AVOID THE RISK OF FIRE OR EQUIPMENT DAMAGE, USE COPPER CONDUCTORS.

CAUTION

GROUNDING REQUIRED!

ALWAYS INSPECT AND USE PROPER SERVICE TOOLS. LACK OF INSPECTION OR IMPROPER TOOLS MAY CAUSE EQUIPMENT DAMAGE OR PERSONAL INJURY. ALL DISCONNECTED GROUNDING DEVICES MUST BE RECONNECTED BEFORE INSTALLING OR SERVICING. MULTIPLE COMPONENTS OF THIS UNIT MAY CONDUCT ELECTRICAL CURRENT; THESE ARE GROUNDED. IF SERVICING THE UNIT, ANY DISCONNECTION OF GROUNDING WIRES, SCREWS, STRAPS, CLIPS, NUTS OR WASHERS USED TO COMPLETE THE GROUND MUST BE RETURNED TO THEIR ORIGINAL POSITION AND PROPERLY FASTENED.

The heat pump unit rating plate lists pertinent electrical data necessary for proper electrical service and overcurrent protection. Wires should be sized to limit voltage drop to 2% (max.) from the main breaker or fuse panel to the condensing unit. Consult the NEC, CEC, and all local codes to determine the correct wire gauge and length.

Local codes often require a disconnect switch located near the unit; do not install the switch on the unit. Refer to the installation instructions supplied with the indoor air handler for specific wiring connections and indoor unit configuration.

OVERCURRENT PROTECTION

The inverter control system software provides sufficient time delay to protect from overcurrent conditions and permit the compressor to adjust their rotational speed.

HIGH VOLTAGE CONNECTIONS

Route power supply and ground wires through the high voltage port and terminate in accordance with the wiring diagram provided inside the control panel cover.

LOW VOLTAGE CONNECTIONS

The unit is designed to work as part of a fully communicating HVAC system, utilizing a ComfortNet™ CTK04 thermostat, ComfortNet compatible indoor unit, and up to four wires. Route control wires through the low voltage port and terminate in accordance with the wiring diagram provided inside the control panel cover.

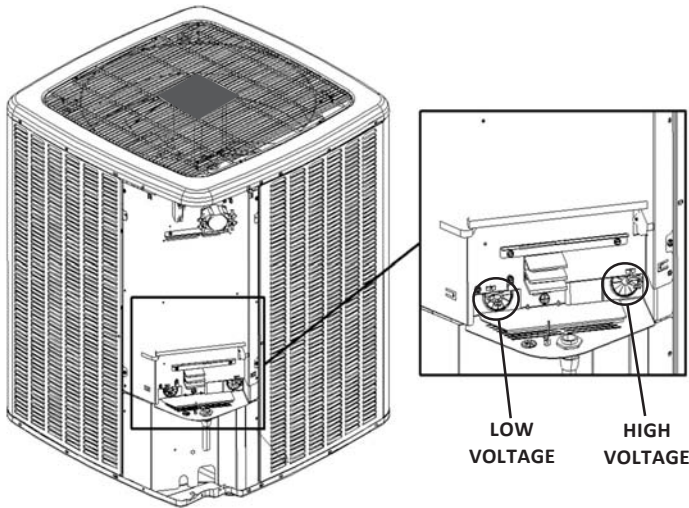

Voltage Ports

Connect low voltage communication wires (1, 2) to low voltage pigtail provided.

THERMOSTAT WIRING

NOTE: A removable plug connector is provided with the control to make thermostat wire connections. This plug may be removed, wire connections made to the plug, and replaced. It is **STRONGLY** recommended that you do not connect multiple wires into a single terminal. Wire nuts are recommended to ensure one wire is used for each terminal. Failure to do so may result in intermittent operation.

Typical 18 AWG thermostat wire may be used to wire the system components. However, communications reliability may be improved by using a high quality, shielded, twisted pair cable for the data transmission lines. In either case, 250 feet is the maximum length of wire between indoor unit and outdoor unit, or between indoor unit and thermostat.

TWO-WIRE OUTDOOR, FOUR-WIRE INDOOR WIRING

Low voltage wiring consists of two wires between the indoor unit and outdoor unit and four wires between the indoor unit and thermostat. The required wires are data lines 1 and 2, "R" (24 VAC hot) and "C" (24 VAC common).

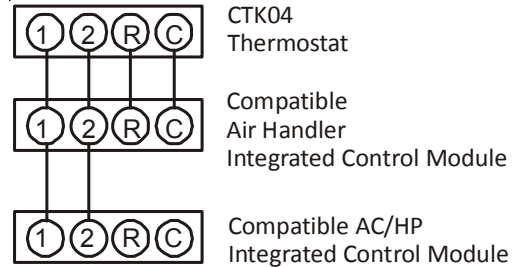

System Wiring

STEP 1. CALCULATE REFRIGERANT CHARGE BASED ON LINE SET LENGTH

The heat pump unit is shipped with a predetermined factory charge level as shown below. For longer line sets greater than 15 feet, add 0.6 ounces of refrigerant per foot. Refer to the following page for the equivalent length of the elbow fittings.

NOTICE

$$\text{TOTAL REFRIGERANT} = \text{FACTORY CHARGE} + (0.6 \text{ OZ./FT.} * \text{ADDITIONAL FEET OF ACTUAL LINE SET}).$$

The following table shows refrigerant amounts for every 5 feet of line.

Actual Line Set Length (ft.)	Unit Tonnage			
	2-Ton	3-Ton	4-Ton	5-Ton
15 (Factory Charge)	139	139	160	237
20	142	142	163	240
25	145	145	166	243
30	148	148	169	246
35	151	151	172	249
40	154	154	175	252
45	157	157	178	255
50	160	160	181	258
55	163	163	184	261
60	166	166	187	264
65	169	169	190	267
70	172	172	193	270
75	175	175	196	273
80	178	178	199	276
85	181	181	202	279
90	184	184	205	282
95	187	187	208	285
100	190	190	211	288

STEP 2. CONNECT HEAT PUMP UNIT TO SYSTEM

CAUTION
OPEN THE LIQUID VALVE FIRST! IF THE GAS SERVICE VALVE IS OPENED FIRST, OIL FROM THE COMPRESSOR MAY BE DRAWN INTO THE INDOOR COIL EEV, RESTRICTING REFRIGERANT FLOW AND AFFECTING OPERATION OF THE SYSTEM.

CAUTION
POSSIBLE REFRIGERANT LEAK!
 TO AVOID A POSSIBLE REFRIGERANT LEAK, OPEN THE SERVICE VALVES UNTIL THE TOP OF THE STEM IS 1/8" FROM THE RETAINER.

CAUTION
 ENSURE VALVES ARE OPEN AND ADDITIONAL CHARGE IS ADDED PER CHART BEFORE APPLYING POWER.

When opening valves with retainers, open each valve only until the top of the stem is 1/8" from the retainer. To avoid loss of refrigerant, DO NOT apply pressure to the retainer. When opening valves without a retainer, remove service valve cap and insert a hex wrench into the valve stem and back out the stem by turning the hex wrench counterclockwise. Open the valve until it contacts the rolled lip of the valve body.

After the refrigerant charge has bled into the system, open the liquid service valve. The service valve cap is the secondary seal for the valves and must be properly tightened to prevent leaks. Make sure cap is clean and apply refrigerant oil to threads and sealing surface on inside of cap. Tighten cap finger-tight and then tighten additional 1/6 of a turn to properly seat the sealing surfaces.

Do not introduce liquid refrigerant from the cylinder into the crankcase of the compressor as this may damage the compressor.

Break vacuum by fully opening liquid and gas base valve.

NOTE: Units may utilize ball valves or front seating valves or front seating valves. It is not necessary to force the stem tightly against the rolled lip.

NOTE: The following table lists the equivalent length gained from adding bends to the suction line. Properly size the suction line to minimize capacity loss.

Type of Elbow Fitting	Inside Diameter (inches)		
	3/4	7/8	1 1/8
90° Short Radius	1.7	2	2.3
90° Long Radius	1.5	1.7	1.6
45°	0.7	0.8	1

ATTENTION INSTALLER - IMPORTANT NOTICE!

Please read carefully before installing this unit.

- For AVZC18, do not install the 24 Volt Transformer that is included with the **CTK04** Thermostat in the Heat Pump Unit; **it is not needed.**
 - Do not attach any wires to the R & C Terminals on the Heat Pump Unit, as they are not needed for inverter unit setup.
 - Data line terminals #1 and #2 are polarity sensitive. *Only the data lines, 1 and 2, are required between the indoor and outdoor units.*
 - Data line terminal #1 from outdoor unit must connect to terminal #1 on indoor unit and thermostat and data line terminal #2 from outdoor unit must connect to terminal #2 on indoor unit and thermostat. *Verify wires are not reversed.*
 - It is strongly recommended to use wire nuts at the indoor unit when connecting multiple data lines or low voltage wires together. It is not recommended to use the terminal block to connect two or more wires.
 - Calculate the Liquid Line Set length and weigh in 0.6 ounces per foot of R410A refrigerant for any length over 15 feet.
- Or
- Charge by Sub-cooling.
 Sub-cooling should be within the range as shown on the chart.
 After adjusting charge, please allow at least 20 minutes for the system to stabilize before making further charge adjustment.

2 T	11±1°F
3 T	14±1°F
4 T	9±1°F
5 T	12±1°F

Dipswitch Default Factory Settings			
Switch #	Setting	Purpose	
OD DS1	1	ON	CT Communication Enabled
	2	ON	CT Communication Enabled
OD DS2	1	OFF	Cooling Emergency Mode for Future Use*
	2	OFF	Cooling Emergency Mode for Future Use*

*OD DS2 switch 1 and 2 both must be turned on during normal operation mode

STEP 3. SYSTEM START-UP TEST

NOTICE

ON INITIAL POWER START-UP, THE OUTDOOR UNIT WILL DISPLAY CODE E11, SIGNALING THAT INITIAL SYSTEM TEST MUST BE RUN. FOLLOW THE COMFORTNET™ SETUP SCREEN TO ENTER APPLICATION-UNIQUE INFORMATION. SEE COMFORTNET THERMOSTAT MANUAL FOR DETAILED INFORMATION.



A system test is now required to check the equipment settings and functionality. Once selected, it checks the equipment for approximately 5 - 15 minutes. System test may exceed 15 minutes if there is an error. Refer to the Troubleshooting section, if error code appears.

Before starting the SYSTEM TEST, turn off the electric heater.

1. Ensure the thermostat is installed.
2. Apply power to outdoor and indoor units.
3. **Start-up.**

After the application information is entered, the initial system test must be run.

NOTICE

FOR INVERTER H/P SYSTEM USING COMFORTNET, DO NOT INSTALL A TRANSFORMER.

The HOME screen will be displayed showing information similar to one of the adjacent screens. Select MENU. Make sure the thermostat is in OFF mode and select SYSTEM menu. Choose OFF before SYSTEM VERIFICATION test.

NOTE: Either screen may be displayed.

SYSTEM TEST must be run for all installations.

System will not operate without a completed initial SYSTEM TEST.

NOTE: The thermostat screen may indicate to run the SYSTEM VERIFICATION test.

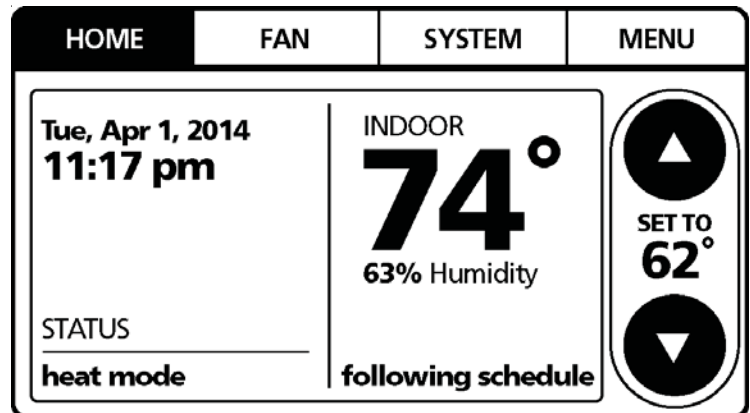
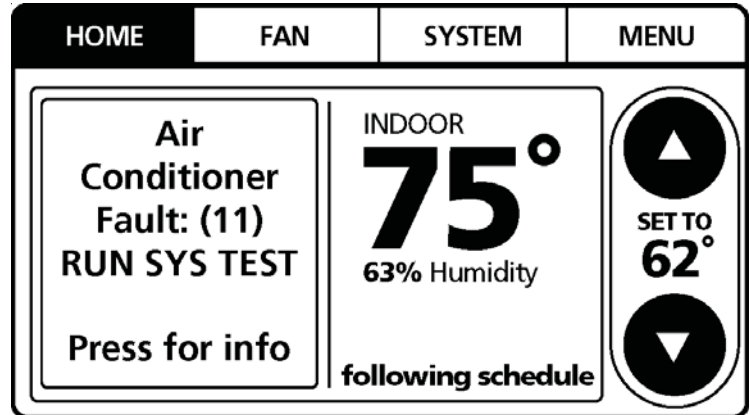

4. From the MENU screen, scroll down and select COMFORTNET™ USER MENU.

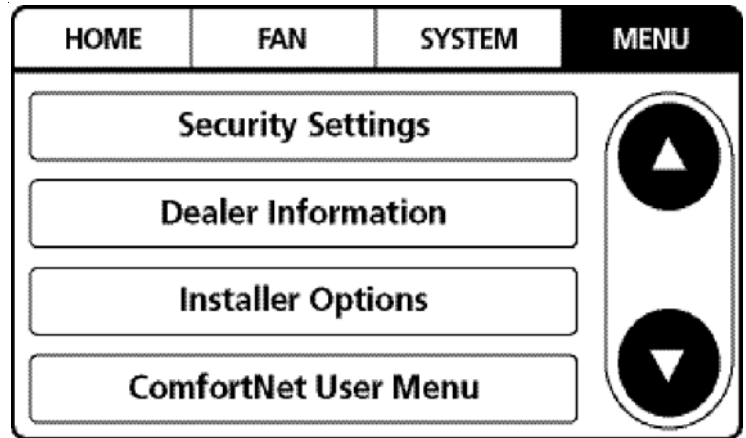

5. Enter Installer password. (The password is the Date Code located on the thermostat and is available by entering the EQUIPMENT STATUS menu and scrolling to the bottom.)

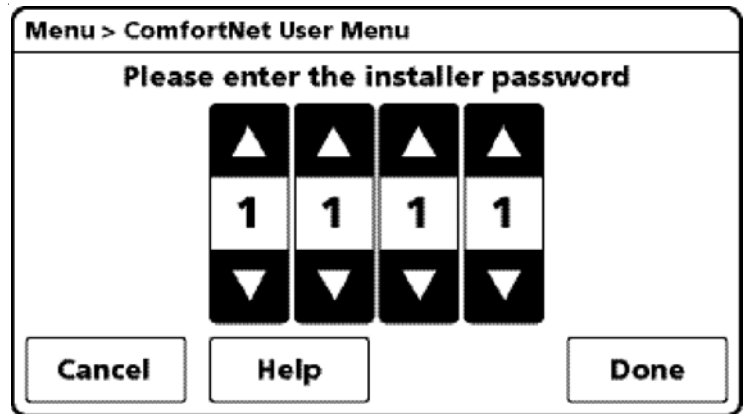

6. Select YES to continue.

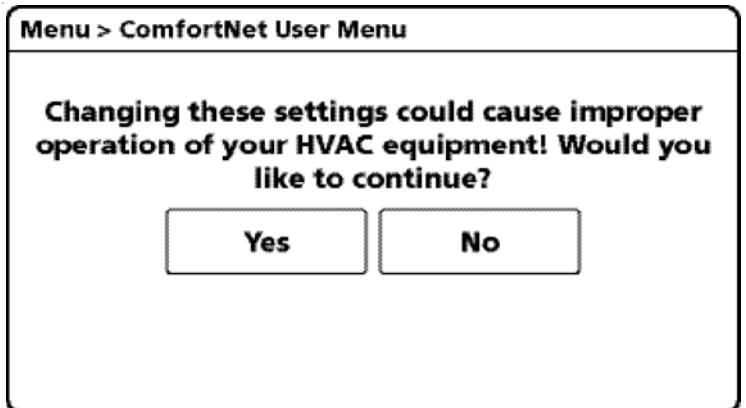

7. From the ComfortNet USER MENU, select HEAT PUMP.

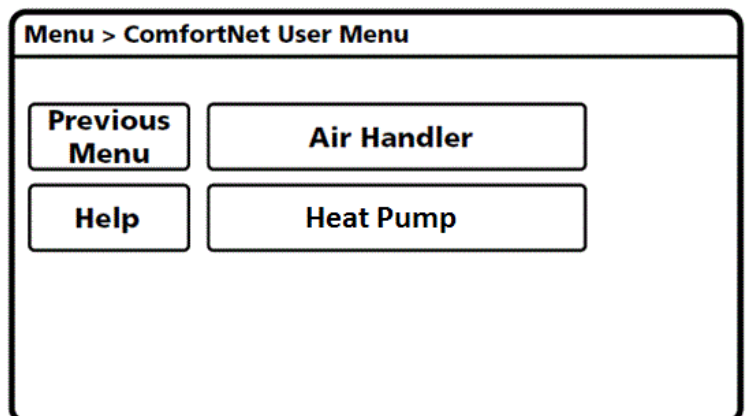

8. Next, scroll down and select EQUIP TEST.

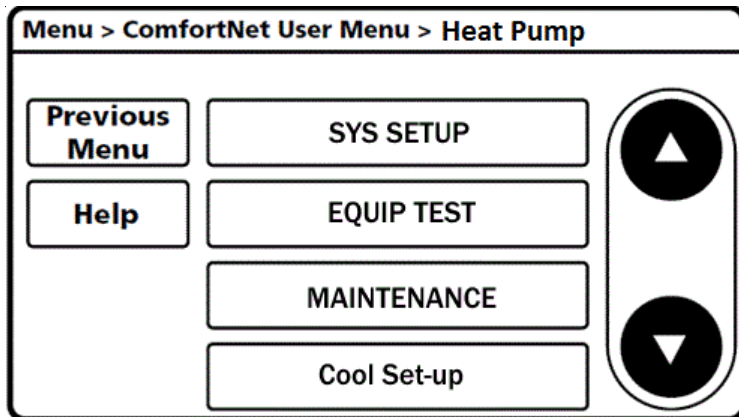

9. Select SYSTEM TEST.

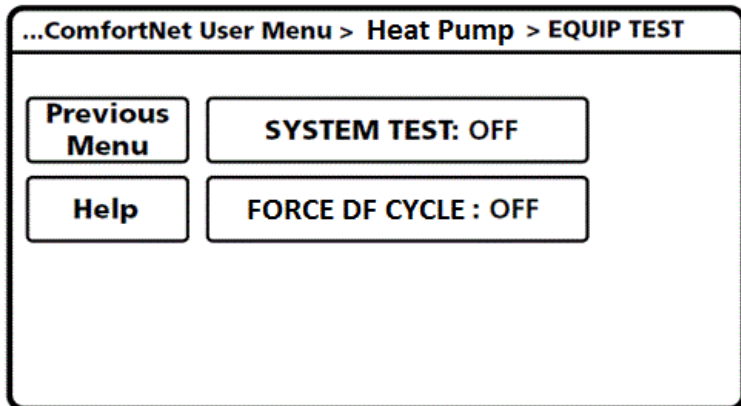

10. Select ON to run the SYSTEM TEST.
Press DONE to initiate test.

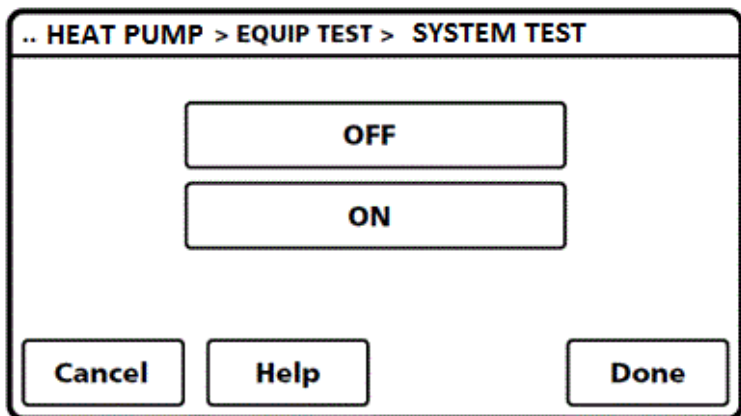

11. Allow the system test to run for its duration (5-15 minutes). EQUIP TEST SCREEN will show the system test is ON once selected. System test will operate the outdoor unit and the indoor unit through a series of startup tests. Please proceed to the next step and allow for startup tests to complete. Do not interrupt power to outdoor unit, indoor unit, or thermostat during system test.

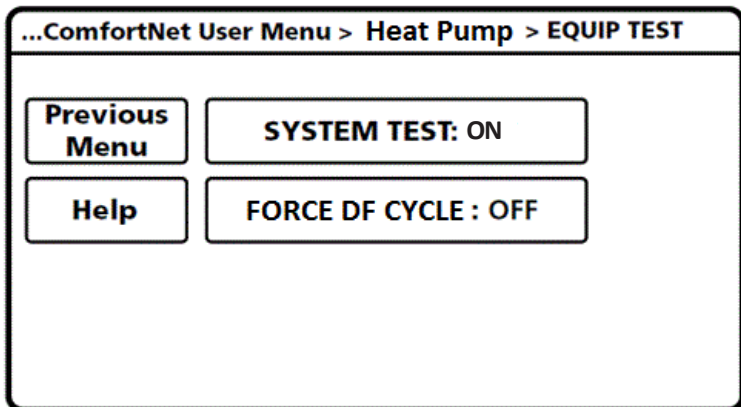

12. Press Previous Menu button and navigate to HOME screen and allow test to finish. The display similar to the one at the right will be displayed after SYSTEM TEST completes. Test is complete only when CODE 11 notice clears from BOTH the thermostat display AND the seven segment LED display on the outdoor unit. Please wait for test to complete and for both codes to clear.

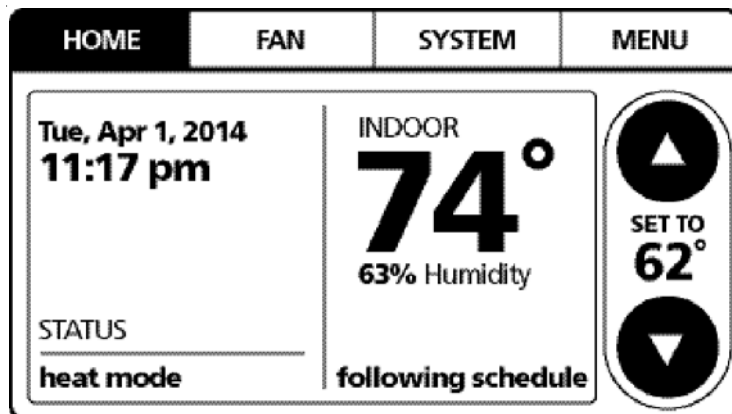

STEP 4. SET THERMOSTAT TO CHARGE MODE

Please follow the following sequence to enter CHARGE MODE. CHARGE MODE allows for charging of the system. System operates for a duration of approximately one hour while the equipment runs at full capacity. After one hour, the CHARGE MODE ends and the system resumes normal thermostat operation.

Before starting the CHARGE MODE, turn off the electric heater.

1. On the HOME screen, select MENU.
NOTE: Ensure the thermostat is in OFF mode. Select SYSTEM menu. Choose OFF before CHARGE MODE.

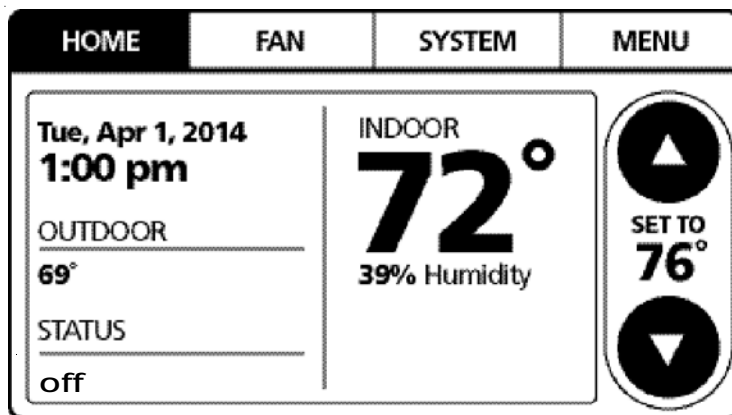

2. From the MENU screen, select COMFORTNET™ USER MENU.

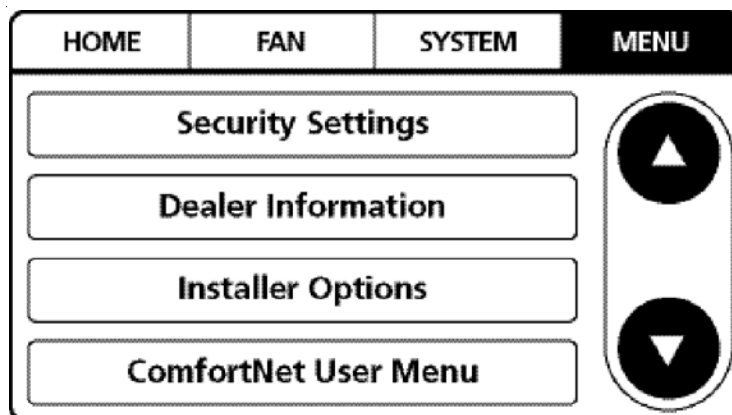

3. Enter Installer password. (The password is the Date Code located on the thermostat and is available by entering the EQUIPMENT STATUS menu and scrolling to the bottom).

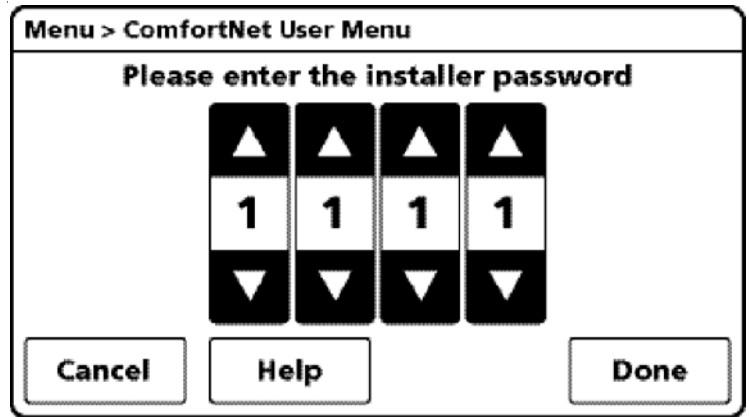

4. Select YES to continue.

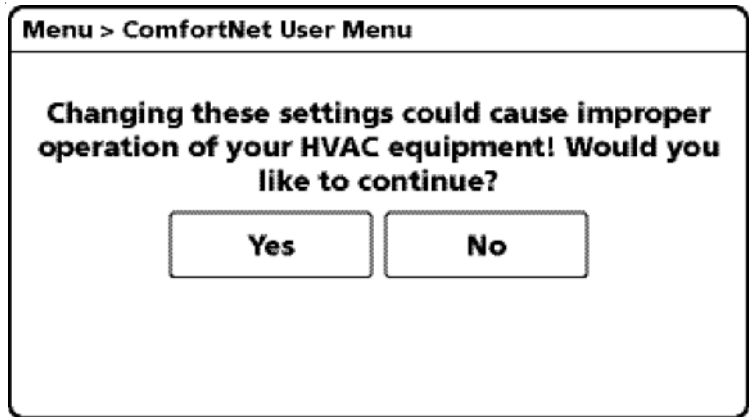

5. Select HEAT PUMP.

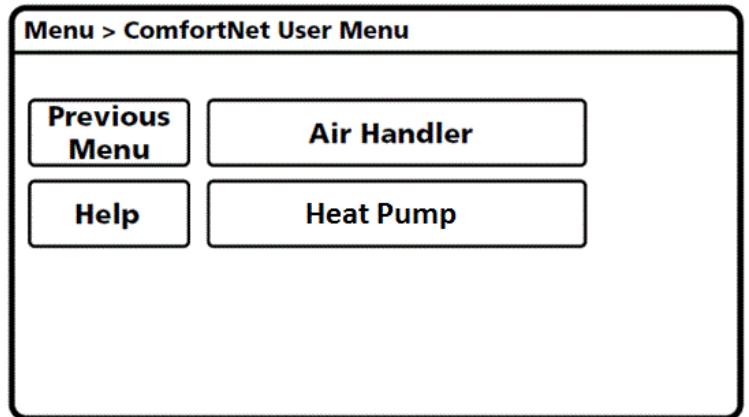

6. Select MAINTENANCE.

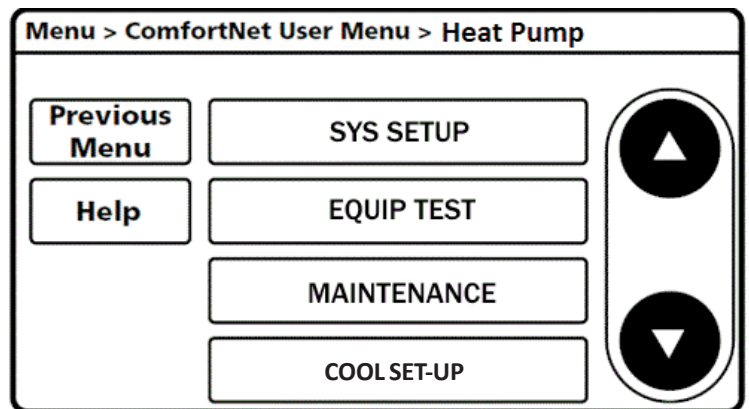

7. Select CHARGE MODE.

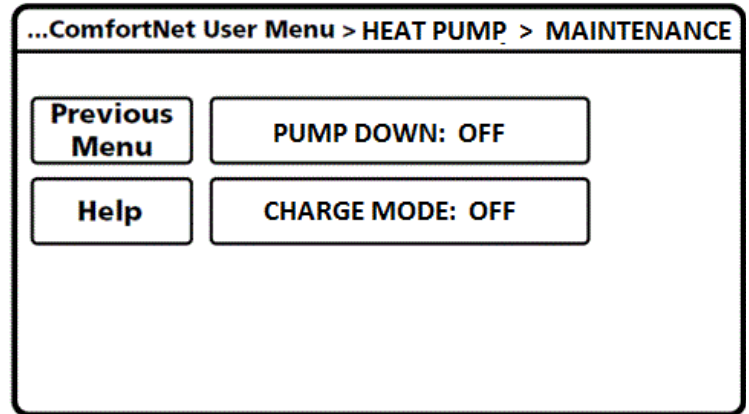

8. Select ON. Press DONE to initiate CHARGE MODE. (System will then run for 1 hour and either return to cooling or heating mode depending if the thermostat is set to COOL or HEAT MODE from the SYSTEM menu on the main screen. If charging is not complete after 1 hour, repeat 7. and 8. Refer to STEP 5 and STEP 6 for refrigerant charge level adjustment.

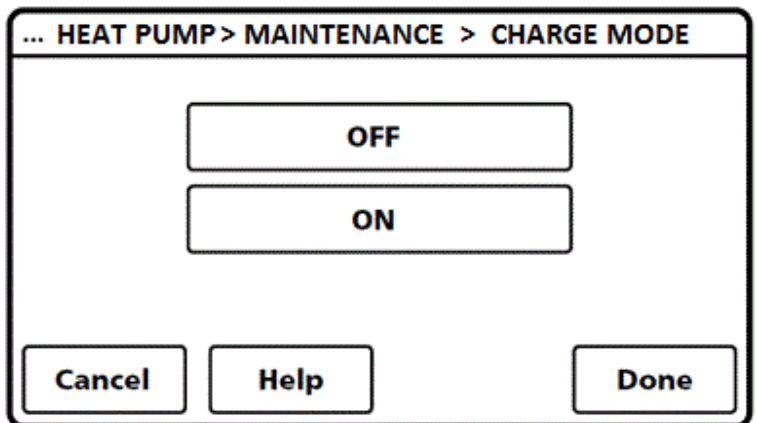

9. To terminate CHARGE MODE, select CHARGE MODE screen again. Press OFF. Press DONE to terminate CHARGE MODE.

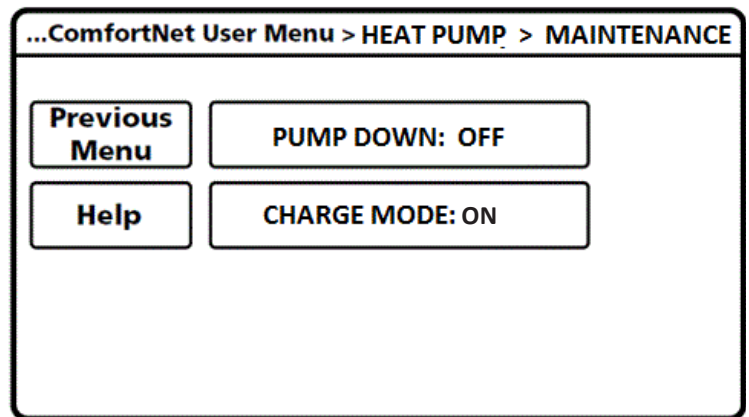

10. Once CHARGE MODE is complete and has been terminated, navigate to HOME screen. Enter normal operation with temperature offset or thermostat schedule, as desired.

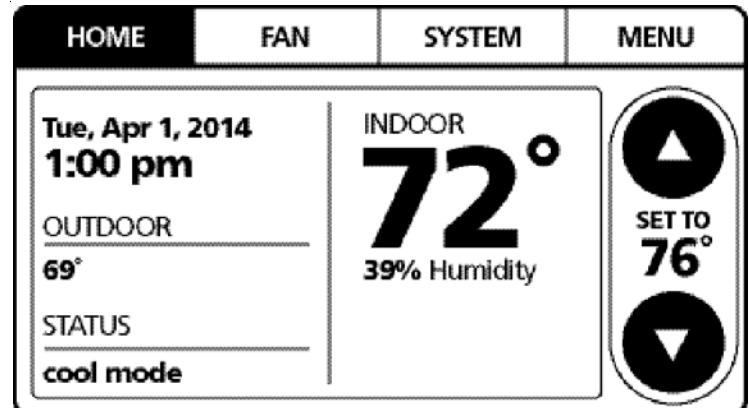

STEP 5. ADJUST REFRIGERANT LEVEL

Using service equipment, add or recover refrigerant according to the calculation in Step 1. Allow system to stabilize for 20 minutes after adjusting charge level.

STEP 6. MEASURE SUBCOOLING TO VERIFY PROPER CHARGE

NOTE: Charging equipment must use dedicated PVE oil gauges and hoses.

1. Purge gauge lines.
2. Connect service gauge manifold to base valve service ports.
3. Convert the liquid pressure to temperature using a temperature/pressure chart.
4. Temporarily install a thermometer on the liquid line at the liquid line service valve.
 - a. Ensure the thermometer makes adequate contact and is insulated for best possible readings.
5. Subtract the liquid line temperature from the converted liquid pressure to determine subcooling.
6. Before starting the Subcooling adjustment, make sure the outdoor ambient temperature is in a below range and the unit is operating at 100% capacity.

SUBCOOLING = (SAT. LIQUID TEMP.) - (LIQUID LINE TEMP.)

Charging Table

OD Ambient Temp (degF)	< 65 °F	65°F to 105°F	> 105 °F
Subcooling (degF)	Weigh in Charge	2 T - 11 ±1°F 3 T - 14 ±1°F 4 T - 9 ±1°F 5 T - 12 ±1°F	Weigh in Charge

Note: Subcooling information is valid only while the unit is operating at 100% capacity or 100% of compressor speed in CHARGE MODE. Compressor speed is displayed under STATUS menu in the thermostat.

7. If the system subcooling is not within the range as shown in the following table, adjust subcooling according to the following procedure.
 - a. If subcooling is low, add charge to adjust the subcooling as specified in the following table.
 - b. If subcooling is high, remove charge to lower the subcooling to:

2 T	11±1°F
3 T	14±1°F
4 T	9±1°F
5 T	12±1°F

NOTE: Not more than 8 oz. or 1/2 lb. of refrigerant be added to the system at a time to achieve the target subcooling. It is recommended adding 4 oz. refrigerant each time, then wait 20 minutes to stabilize the system.

NOTICE

CHECK THE SCHRADER PORTS FOR LEAKS AND TIGHTEN VALVE CORES, IF NECESSARY. INSTALL CAPS FINGER-TIGHT.

NOTICE

DO NOT ADJUST THE CHARGE BASED ON SUCTION PRESSURE UNLESS THERE IS A GROSS UNDERCHARGE.

SATURATED SUCTION PRESSURE TEMPERATURE CHART	
SUCTION PRESSURE PSIG	R-410A °F
50	1
52	3
54	4
56	6
58	7
60	8
62	10
64	11
66	13
68	14
70	15
72	16
74	17
76	19
78	20
80	21
85	24
90	26
95	29
100	31
110	36
120	41
130	45
140	49
150	53
160	56
170	60

SATURATED LIQUID PRESSURE TEMPERATURE CHART	
LIQUID PRESSURE PSIG	R-410A °F
200	70
210	73
220	76
225	78
235	80
245	83
255	85
265	88
275	90
285	92
295	95
305	97
325	101
355	108
375	112
405	118
415	119
425	121
435	123
445	125
475	130
500	134
525	138
550	142
575	145
600	149
625	152

HEAT PUMP WITH OUTDOOR TEMPERATURE LOCKOUTS

It is recommended to set the outdoor temperature lockouts during the initial thermostat set up. Compressor lockout temperature will enable the compressor to be turned off and switch heating source from refrigeration to auxiliary/secondary heating under low outdoor ambient conditions.

Backup heat lockout temperature will enable auxiliary/secondary heating to be turned on when outdoor temperature is much higher than indoor temperature, compressor might stop operating under this circumstance.

Backup Heat Lockout Temperature (-)	Compressor Lockout Temperature (F°)
OFF	15

In order to access temperature, the compressor lockout and the backup heat lockout, press **MENU** and scroll down to press **INSTALLER OPTIONS**. Enter the date code (password) when prompted. Choose **VIEW / EDIT CURRENT SETUP** and **COMPRESSOR LOCKOUT / BALANCE POINT** will be under **HEAT / COOL CONTROL OPTIONS**. For more information please refer to **COMFORTNET™ CTK04** Communicating Thermostat **SYSTEM INSTALLATION GUIDE**.

FIELD SELECTABLE BOOST MODE

BOOST MODE enables the system to operate at increased compressor speed to satisfy unusual high loads. BOOST MODE is initiated by an outdoor temperature sensor located in the outdoor unit. Please note that outdoor equipment operational sound levels may increase while the equipment is running in BOOST MODE. Disabling BOOST MODE will provide the quietest and most efficient operation.

NOTE: BOOST MODE performance is most effective when paired with an electronic expansion valve enabled indoor unit.

NOTE: BOOST MODE is ON by default and is activated when the outdoor temperature reaches 105°F. BOOST MODE can be disabled and enabled and the activation temperature adjusted in BOOST TEMP menu using the following procedure:

1. On the HOME screen, select MENU.

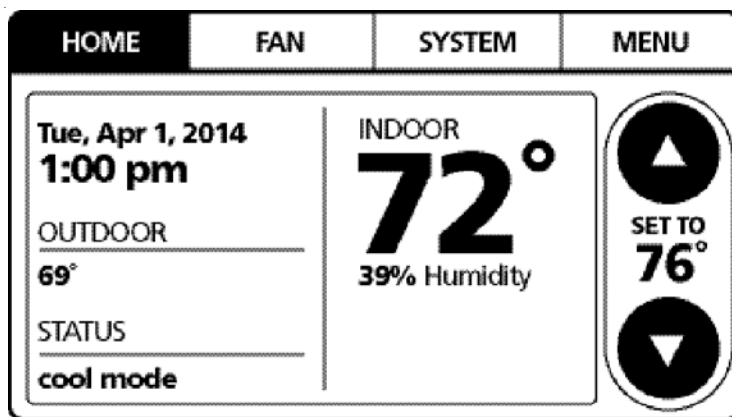

2. From the MENU screen, select COMFORTNET™ USER MENU.

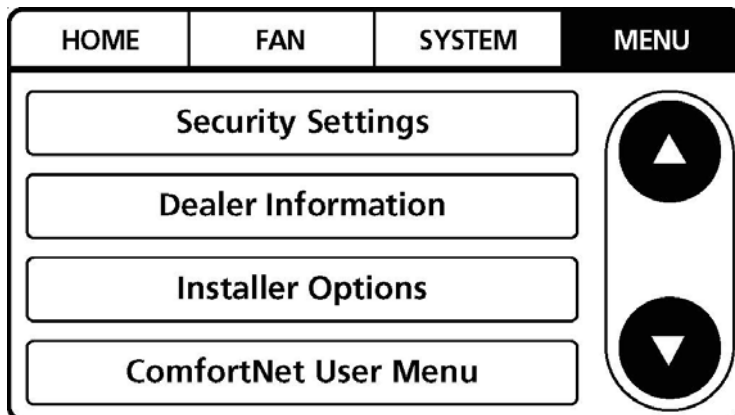

3. Enter Installer password if known.

a. The password is the thermostat date code and can be obtained by selecting the red Cancel button and selecting the Dealer Information button.

b. Once recorded, click the green OK button and return to the previous step.

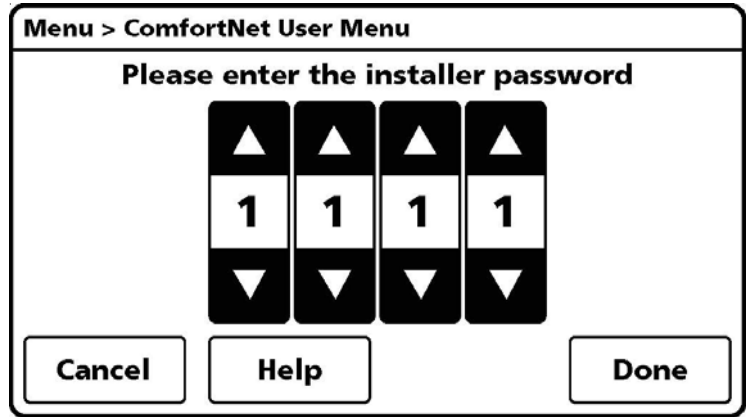

4. Select YES to continue.

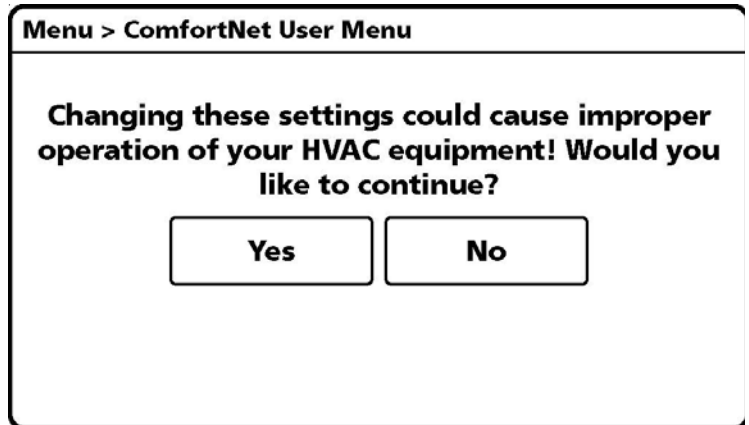

5. Select HEAT PUMP.

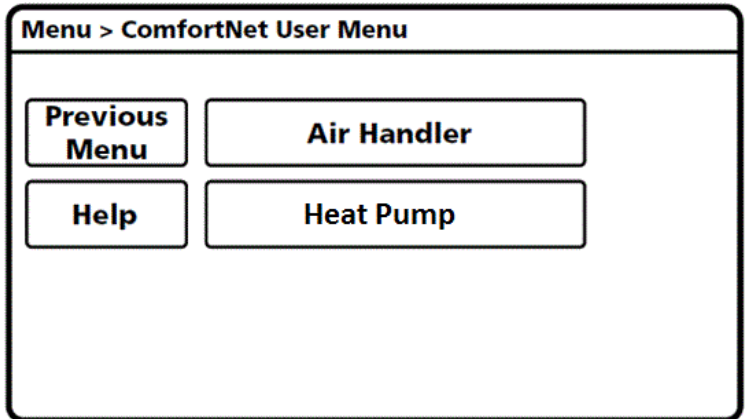

6. Select SYS SETUP.

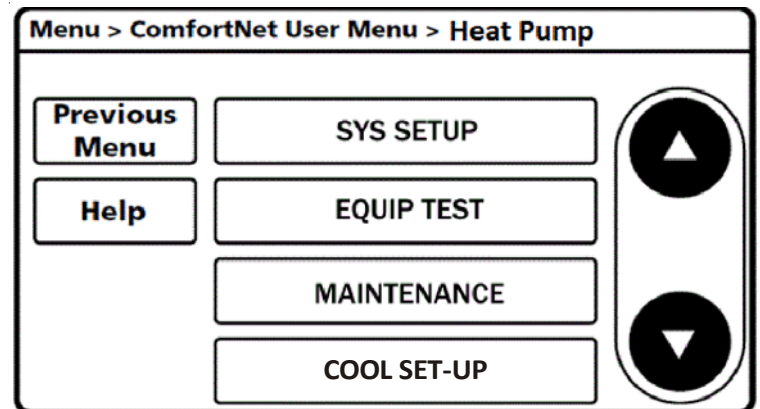

7. BOOST MD turns BOOST MODE OFF or ON. BOOST MODE is ON by default.

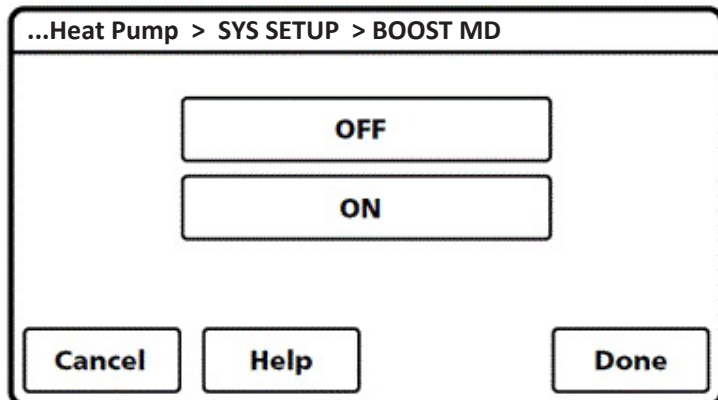
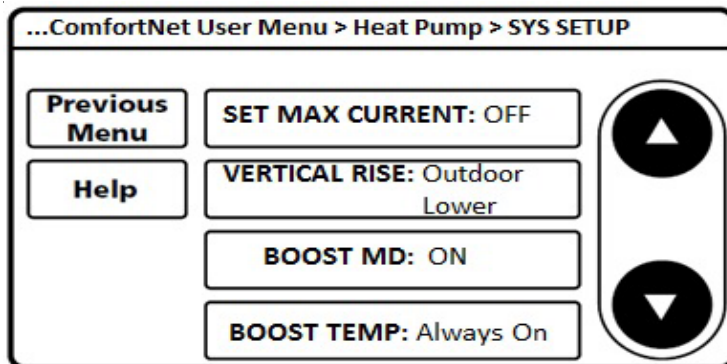

8. BOOST TEMP adjusts the activation temperature from 70° to 105°. "Always ON" option is also available to permanently engage BOOST MODE. Factory default is 105°.

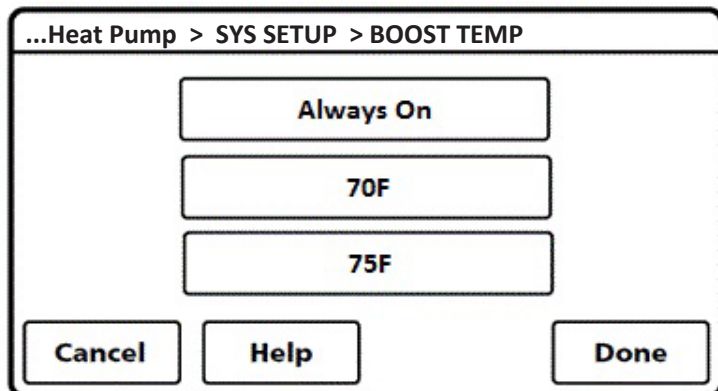
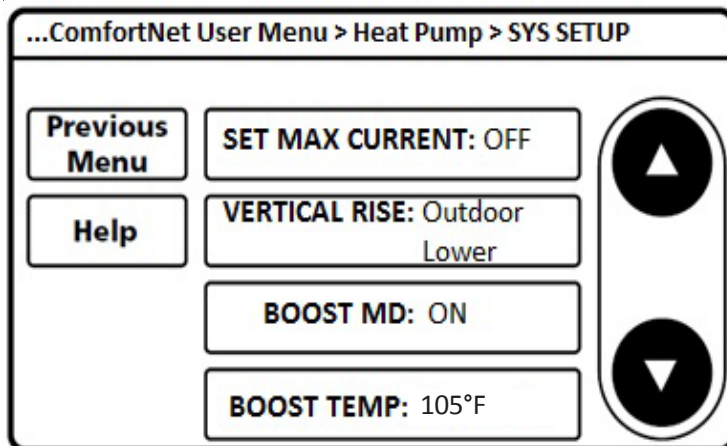

- Once satisfied with BOOST MODE adjustments, navigate to the HOME screen by selecting the Previous Menu button three times then selecting HOME.

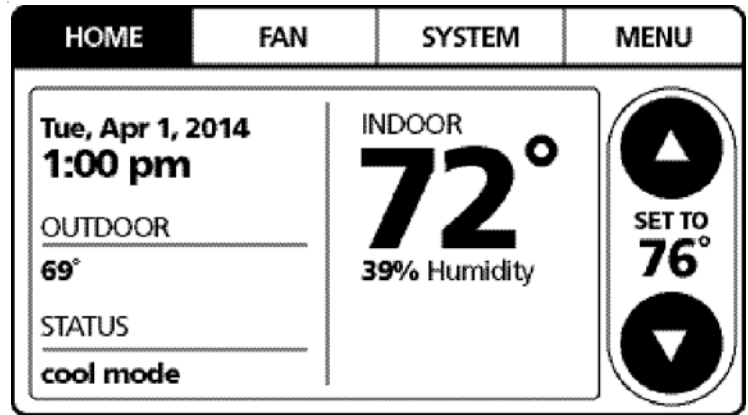

DEHUMIDIFICATION

The thermostat reads the indoor humidity level from the CTK04 and allows the user to set a dehumidification target based on these settings. The thermostat controls the humidity level of the conditioned space using the cooling system. Dehumidification is engaged whenever a cooling demand is present and structural humidity levels are above the target level. When this condition exists the circulating fan output is reduced, increasing system run time, over cooling the evaporator coil and ultimately removing more humidity from the structure than if only in cooling mode. The CTK04 also allows for an additional overcooling limit setting from 0 °F to 3 °F setup through the Installer Option menu (direction below). This allows the cooling system to further reduce humidity by lowering the temperature up to 3° F below the cooling setpoint in an attempt to better achieve desired humidity levels.

By default dehumidification needs to be turned ON at the thermostat via the Dehumidification Equipment menu. Dehumidification can be activated at the original equipment setup by selecting the A/C with Low Speed Fan button in the Dehumidification Menu. Availability can be verified by pressing MENU on the home screen. Scroll down and if a Dehumidification button is present dehumidification is activated.

If Dehumidification is not available in the menu then it must be enabled through the Installer Options menu. Use the following procedure to enable and disable dehumidification:

- On the CTK04 HOME screen, select MENU.
- From the MENU screen, scroll down and select Installer Options.
- Enter installer password if known.
 - The password is the thermostat date code and can be obtained by selecting the red Cancel button and selecting the Dealer Information button.
 - Once recorded click the green OK button and return to the previous step.
- Select YES to continue.
- Select View / Edit Current Setup.
- Scroll down and select Dehumidification.
- Once open select Dehumidification Equipment: None.
- From the Dehumidification Menu select A/C with Low Speed Fan and click the green Done button.

- Additional Dehumidification operational options can be selected in the resulting window.
- Once satisfied with the selection navigate to the HOME screen by selecting the Done button and selecting Yes to verify the changes.
- Select Previous Menu, then the HOME to return to the main menu.

DEHUMIDIFICATION TIPS

For effective dehumidification operation:

- Ensure “Dehum” is ON through the Installer Options menu and/or in the ComfortNet User Menu (COOL SETUP).
 - If ON, the Dehumidification menu should be visible in the main menu.
- Verify the cooling airflow profile is set to “Profile D”.
 - See the Cool Set-up section of the Installation Manual for complete airflow profile details.
 - By default “Dehum” is ON and the cooling airflow profile is set to “Profile D”.
- For additional dehumidification control, airflow settings are field adjustable and can be fine-tuned to a value that is comfortable for the application from a range of +15% to -15%.
 - See the Heat Pump Advanced Feature Menu section of the Installation Manual for more detail.

COMFORTNET™ SYSTEM

OVERVIEW

A ComfortNet inverter heating and air conditioning system uses an indoor unit, outdoor unit and thermostat which digitally communicate with one another via a two-way communications path. The thermostat sends commands to the indoor and outdoor units. The thermostat may request and receive information from both the indoor and outdoor units. This information may be displayed on the CTK04 thermostat. The indoor and outdoor units also interact with one another. The outdoor unit may send commands to or request information from the indoor unit. This two-way digital communications between the thermostat and subsystems (indoor/outdoor unit) and between subsystems is the key to unlocking the benefits and features of the ComfortNet system.

Two-way digital communications is accomplished using only two wires. The thermostat needs 24 VAC for power. 4 wires between the indoor unit and thermostat plus two wires between the indoor unit and outdoor unit are all that are required to operate the system.

COMFORTNET SYSTEM ADVANCED FEATURES

The ComfortNet™ system permits access to additional system information, advanced set-up features, and advanced diagnostic/troubleshooting features. These advanced features are organized into a menu structure. See the **HEAT PUMP ADVANCED FEATURES MENU** section for the menu layout.

DIRECTIONS TO HEAT PUMP ADVANCED FEATURE MENUS

Press **MENU**, scroll down and press **COMFORTNET USER MENU**. Enter the date code (password) when prompted. The date code is printed on the back of the thermostat; or press **MENU > EQUIPMENT STATUS** and scroll down to find the date code. After you enter the password, select COMFORTNET USER MENU, answer YES to the following menu and select HEAT PUMP to view the system menus.

DIAGNOSTICS

The heat pump's diagnostics menu provides access to the most recent faults. The six most recent faults are displayed on the first screen. Faults are stored in order from most recent to least recent. Any consecutively repeated fault is stored a maximum of three times. Example: A leak in the system, low refrigerant charge or an incompletely open stop valve can cause the unit to flash error code E15. This error code suggests that the unit is experiencing operation at low pressure. The control will only store this fault the first three *consecutive* times the fault occurs.

NOTE: It is highly recommended that the fault list be cleared after performing maintenance or servicing the system.

STATUS

This menu displays information about the systems current status. This menu can be utilized to confirm correct functionality of the equipment and for troubleshooting purposes. The following items will be displayed:

TS	Time Stamp
MD	Mode
CRM	Compressor Reduction Mode
RAD	Requested and Actual % Demand
RAF	Requested and Reported ID CFM
ATOF	Outdoor Air Temperature and Outdoor Fan STATUS
DCT	Discharge Temperature and Outdoor Coil Temperature
DLT	Defrost Sensor and Outdoor Liquid Temperature
PSDST	Pressure Sensor and Outdoor Suction Temperature

Time Stamp: Provides compressor run time in hours.

Mode: Current system operational mode (COOLING, HEATING, COOLING STARTUP, HEATING STARTUP, OIL RETURN, DEFROST, STOP).

Compressor Reduction Mode: The compressor is running at a speed lower than what is requested, based on the cooling load.

Requested and Actual % Demand: Compares the requested cooling demand to what the equipment is providing. For steady state operation, these number should match.

Requested and Reported ID CFM: Compares the requested indoor airflow to what the indoor equipment has reported.

Outdoor Air Temperature and Outdoor Fan TAP: Displays the outdoor air temperature as well as the outdoor fan speed (**TAP**).

O: Off; 1: Low Tap; 2: Medium Tap; 3: High Tap

Discharge Temperature and Outdoor Coil Temperature: Displays the discharge temperature and outdoor coil temperature sensor readings.

Defrost Sensor and Outdoor Liquid Temperature: Displays defrost sensor and outdoor liquid temperature sensor readings.

Pressure Sensor and Outdoor Suction Temperature: Displays the pressure sensor and outdoor suction temperature sensor reading.

NOTE: Oil Return Mode: In order to properly return oil to the compressor, compressor speed may periodically adjust to assist oil circulation.

MAINTENANCE

Pump down and charge modes can be enabled within this menu.

SYSTEM SETUP

This menu allows for the setting of BOOST MODE. BOOST MODE enables the system to operate at a higher compressor speed than maximum compressor speed.

BOOST MODE temperature can be adjusted in BOOST TEMP menu. When ambient temperature gets higher than BOOST MODE temperature, the system will operate in BOOST MODE.

EQUIPMENT TEST

The mandatory system verification test is enabled from this menu, which enables a functional check of the equipment, in addition to ensuring proper stop valve position. The heat pump unit can be set to manual defrost from this menu by selecting FORCE DF CYCLE.

COOL SET-UP

This menu allows for the adjustment of several cooling performance variables. Cool Airflow Trim (range from -15% to +15% in 3% increments), Cool Airflow Profiles, Cool Fan ON Delay, Cool Fan OFF Delay and Dehumidification Select (enable or disable dehumidification) can be adjusted in this menu. You can also reset this entire menu to factory default settings. See the following images showing the four cooling airflow profiles.

- **Profile A** provides only an OFF delay of one (1) minute at 100% of the cooling demand airflow.

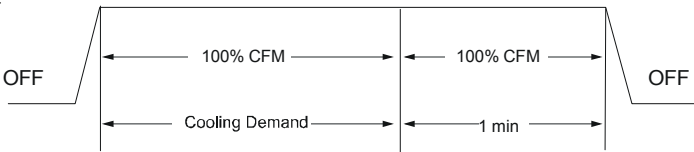

- **Profile B** ramps up to full cooling demand airflow by first stepping up to 50% of the full demand for 30 seconds. The motor then ramps to 100% of the required airflow. A one (1) minute OFF delay at 100% of the cooling airflow.

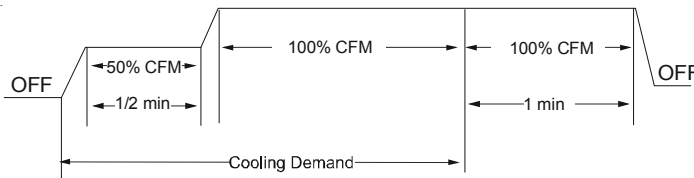

- **Profile C** ramps up to 82% of the full cooling demand airflow and operates there for approximately 7 1/2 minutes. The motor then steps up to the full demand airflow. Profile C also has a one (1) minute 100% OFF delay.

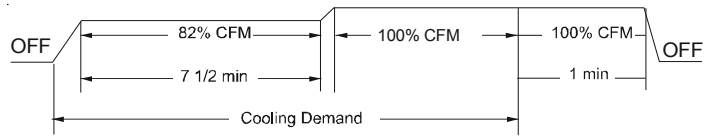

- **Profile D** (default) ramps up to 50% of the demand for 1/2 minute, then ramps to 82% of the full cooling demand airflow and operates there for approximately 7 1/2 minutes. The motor then steps up to the full demand airflow. Profile D has a 1/2 minute at 50% airflow OFF delay.

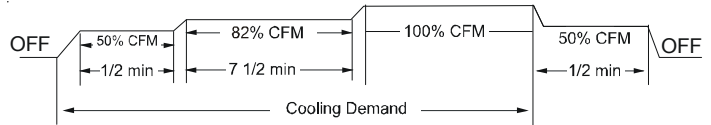

Airflow Tables

See service manual for more detailed information.

COOL RUN VALUES

Depending on the system configuration, adjusting the maximum compressor RPS (revolutions per second) may be required. Necessary adjustments to the maximum compressor RPS are made through the following sub-menus.

MAXIMUM COMPRESSOR RPS RANGE FOR COOLING

Select the range that your maximum compressor RPS falls within.

MAXIMUM COMPRESSOR RPS SELECTION FOR COOLING

Within the selected range, choose the specific maximum compressor RPS for the system configuration.

HEAT SET-UP

This menu allows for the adjustment of several heating performance variables. Heat Airflow trim (range from -15% to +15% in 3% increments), Heat Fan ON Delay, Heat Fan OFF Delay and timed Defrost interval can be adjusted in this menu. Time interval of 30, 60, 90 and 120 minutes between two defrost cycles can be set to suit the weather conditions and performance of the unit.

HEAT RUN VALUES

Similar to cooling mode, the maximum compressor speed RPS (revolutions per second) can be adjusted for heating mode under this menu.

MAXIMUM COMPRESSOR RPS RANGE FOR HEATING

Select the range that your maximum compressor RPS falls within.

MAXIMUM COMPRESSOR RPS SELECTION FOR HEATING

Within the selected range, choose the specific maximum compressor RPS for the system configuration.

See service manual for more detailed information.

HEAT PUMP ADVANCED FEATURE MENU

DIAGNOSTICS		
SUBMENU ITEM	INDICATION/USER MODIFIABLE OPTIONS	COMMENTS
Clear Faults	NO or YES	Selecting "YES" clears the fault history.
Fault 1	Most recent HP fault	
Fault 2	2nd most recent HP fault	
Fault 3	3rd most recent HP fault	
Fault 4	4th most recent HP fault	
Fault 5	5th most recent HP fault	
Fault 6	6th most recent HP fault	

STATUS	
SUBMENU ITEM	COMMENTS
Time Stamp (TS)	Provides compressor run time in hours.
Mode (MD)	Current system operation mode (COOLING, COOLING STARTUP, HEATING, HEATING STARTUP, DEFROST, OIL RETURN, STOP).
Compressor Reduction Mode (CRM)	Displays ON or OFF status. ON indicates that the reduction mode is operating and the compressor is running at a lower speed than the cooling load would normally require.
Requested and Actual % Demand (RAD)	Displays a 0-100% value, based on a ratio of the requested cooling demand to what the system is actually providing.
Requested and Reported ID CFM (RAF)	Compares the requested indoor airflow to what the indoor equipment has reported.
Outdoor Air Temperature and Outdoor Fan Status (ATOF)	Displays the outdoor air temperature as well as the outdoor fan speed (TAP). O: Off; 1: Low Tap; 2: Medium Tap; 3: High Tap
Discharge Temperature and Outdoor Coil Temperature (DCT)	Displays the discharge temperature and outdoor coil temperature sensor readings.
Defrost sensor and Outdoor Liquid Temperature (DLT)	Displays the defrost temperature sensor and outdoor liquid temperature sensor reading.
Pressure Sensor and Suction Temperature (PSDST)	Displays the pressure sensor reading which is taken slightly upstream of the suction accumulator and outdoor suction temperature sensor reading.

SYSTEM SETUP (SYS SETUP)		
SUBMENU ITEM	USER MODIFIABLE OPTIONS	COMMENTS
Reset System Setup Options to Factory Defaults	NO or YES	Selecting "YES" resets this menu to factory default settings.
SET MAX CURRENT	N/A	Future use.
VERTICAL RISE	Same Level, Outdoor Lower, or Indoor Lower	If the outdoor & indoor units are within +/- 15 ft. vertical distance, select SAME LEVEL. If the outdoor unit is more than 15 ft. below the indoor unit, select OUTDOOR LOWER. If the outdoor unit is more than 15 ft. above the indoor unit, select INDOOR LOWER.
BOOST MODE	ON or OFF	BOOST MD turns BOOST MODE OFF or ON. BOOST MODE is ON by default. See BOOST MODE section of this manual for more details.
BOOST MODE TEMPERATURE	Always ON, 70, 75, 80, 85, 90, 95, 100, 105F	BOOST TEMP adjusts the activation temperature from 70°F to 105°F. An "Always ON" option is also available to permanently engage BOOST MODE.
EQUIPMENT TEST (EQUIP TEST)		
SUBMENU ITEM	INDICATION/USER MODIFIABLE OPTIONS	COMMENTS
System Verification Test (SYSTEM TEST)	ON or OFF	System Verification Test must be run after installation. This is approximately a 5-15 minute test. If the thermostat is set to COOL mode, the system will enter CHARGE mode upon completion, otherwise it will stop.
Force Defrost Cycle (FORCE DF CYCLE)	ON or OFF	This will make the unit run in defrost mode.
SYSTEM MAINTENANCE		
SUBMENU ITEM	USER MODIFIABLE OPTIONS	COMMENTS
PUMP DOWN	ON or OFF	Enter PUMP DOWN Mode. This procedure runs the equipment for approximately 15 minutes and allows accumulation of refrigerant at the outdoor unit for purposes of removing & replacing the indoor unit or outdoor unit.
CHARGE MODE	ON or OFF	Enter Charging Mode. This allows for a steady system operation for a duration of approximately 1 hour to allow for refrigerant charging of the system via the suction charge port. The system will stop after completion.

HEAT PUMP ADVANCED FEATURE MENU

COOL SETUP		
SUBMENU ITEM	USER MODIFIABLE OPTIONS	COMMENTS
CL Reset	YES or NO	Selecting to default factory setting.
Cool Airflow Trim Hi	-15% to +15% in 3% increments	Selects the cooling airflow trim amount.
Cool Airflow Trim Int	-15% to +15% in 3% increments	Selects the cooling airflow trim amount.
Cool Airflow Trim Low	-15% to +15% in 3% increments	Selects the cooling airflow trim amount.
Cool Airflow Profile	A, B, C, or D	Selects the cooling airflow profile.
Cool ON Delay	5, 10, 20, 30 seconds	Selects the indoor blower ON delay.
Cool OFF Delay	30, 60, 90, 120 seconds	Selects the indoor blower OFF delay.
Dehumidification Select	ON or OFF	Selecting OFF disables dehumidification; selecting ON enables dehumidification.

SET COOLING RUN VALUES (CL RUN VALUES)		
SUBMENU ITEM	USER MODIFIABLE OPTIONS	COMMENTS
Maximum Compressor RPS Range for Cooling (COOL RPS RANGE)	Five different compressor RPS ranges will be provided.	Select the appropriate range for the installed system configuration.
Maximum Compressor RPS Selection for Cooling (COOL RPS SELECT)	10 compressor RPS values will be provided within the range selected in the COOL RPS RANGE menu	Select the appropriate compressor RPS for the installed system configuration.

HEAT SETUP		
SUBMENU ITEM	USER MODIFIABLE OPTIONS	COMMENTS
HT Reset	YES or NO	Selecting to default factory setting.
Heat Airflow Trim Hi	-15% to +15% in 3% increments	Selects the Heating airflow trim amount.
Heat Airflow Trim Int	-15% to +15% in 3% increments	Selects the Heating airflow trim amount.
Heat Airflow Trim Low	-15% to +15% in 3% increments	Selects the Heating airflow trim amount.
Heat ON Delay	5, 10, 15 seconds	Selects the indoor blower ON delay.
Heat OFF Delay	30, 50, 70, 90 seconds	Selects the indoor blower OFF delay.
Maximum Defrost Interval	30 mins., 1 hr., 1.5 hrs. & 2 hrs.	Selects time defrost interval

SET HEATING RUN VALUES (HT RUN VALUES)		
SUBMENU ITEM	USER MODIFIABLE OPTIONS	COMMENTS
Maximum Compressor RPS Range for Heating (HEAT RPS RANGE)	Five different compressor RPS ranges will be provided.	Select the appropriate range for the installed system configuration.
Maximum Compressor RPS Selection for Heating (HEAT RPS SELECT)	10 compressor RPS values will be provided within the range selected in the HEAT RPS RANGE menu	Select the appropriate compressor RPS for the installed system configuration.

WARNING
 HIGH VOLTAGE!
 DISCONNECT ALL POWER BEFORE SERVICING OR INSTALLING THIS UNIT. MULTIPLE POWER SOURCES MAY BE PRESENT. FAILURE TO DO SO MAY CAUSE PROPERTY DAMAGE, PERSONAL INJURY OR DEATH.

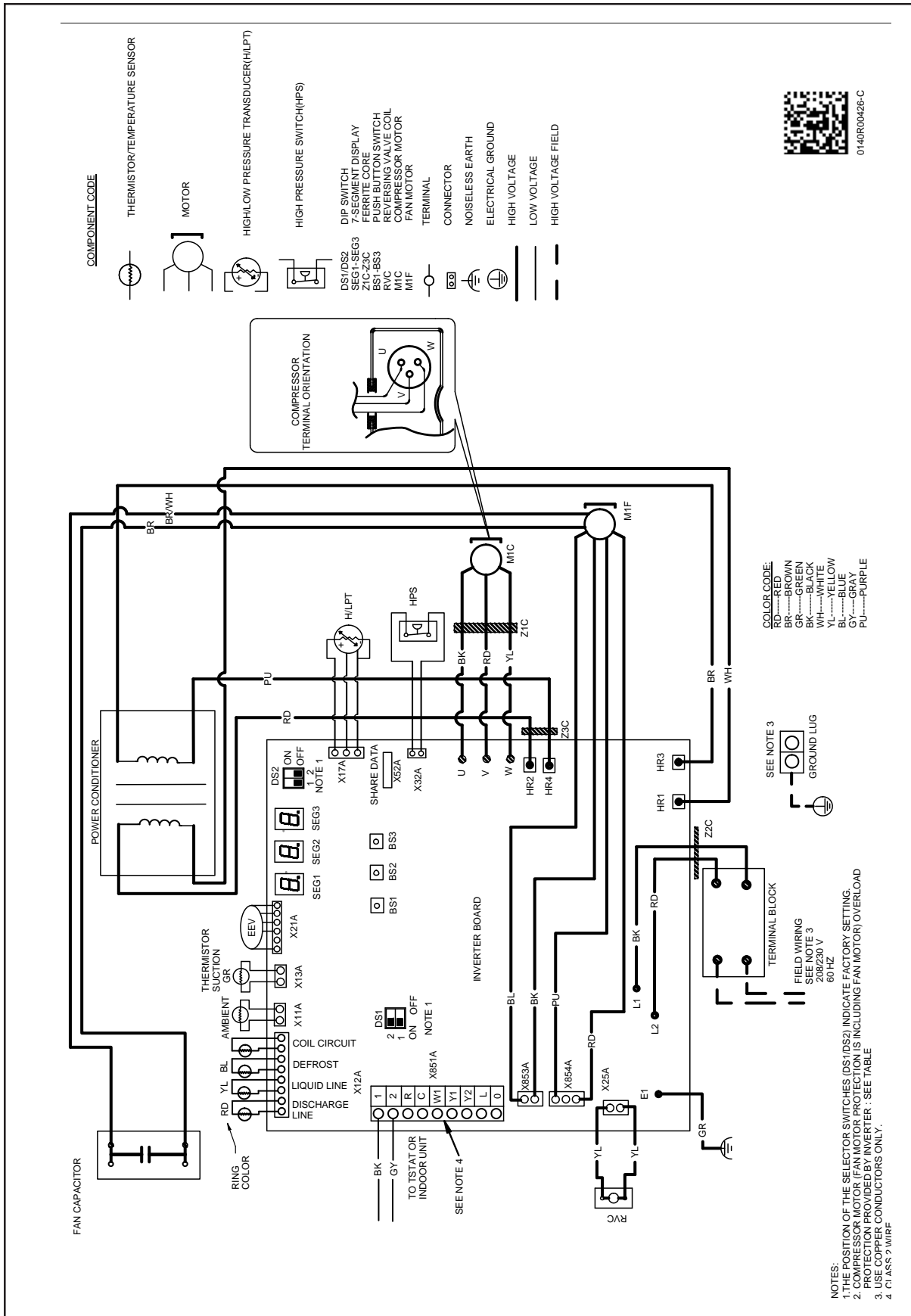

Wiring is subject to change. Always refer to the wiring diagram on the unit for the most up-to-date wiring.

CAPACITOR

⚠ WARNING

AVOID CONTACT WITH THE CHARGED AREA.

• NEVER TOUCH THE CHARGED AREA BEFORE CONFIRMING THAT THE RESIDUAL VOLTAGE IS 50 VOLTS OR LESS.

1. SHUT DOWN THE POWER AND LEAVE THE CONTROL BOX FOR 10 MINUTES.
2. MAKE SURE TO TOUCH THE EARTH GROUND TERMINAL TO RELEASE THE STATIC ELECTRICITY FROM YOUR BODY (TO PREVENT FAILURE OF THE PC BOARD).
3. MEASURE THE RESIDUAL VOLTAGE IN THE SPECIFIED MEASUREMENT POSITION USING A VOM WHILE PAYING ATTENTION NOT TO TOUCH THE CHARGED AREA.
4. IMMEDIATELY AFTER MEASURING THE RESIDUAL VOLTAGE, DISCONNECT THE CONNECTORS OF THE OUTDOOR UNIT'S FAN MOTOR. (IF THE FAN BLADE ROTATES BY STRONG WIND BLOWING AGAINST IT, THE CAPACITOR WILL BE CHARGED, CAUSING THE DANGER OF ELECTRICAL SHOCK.)

2 - 3 TON

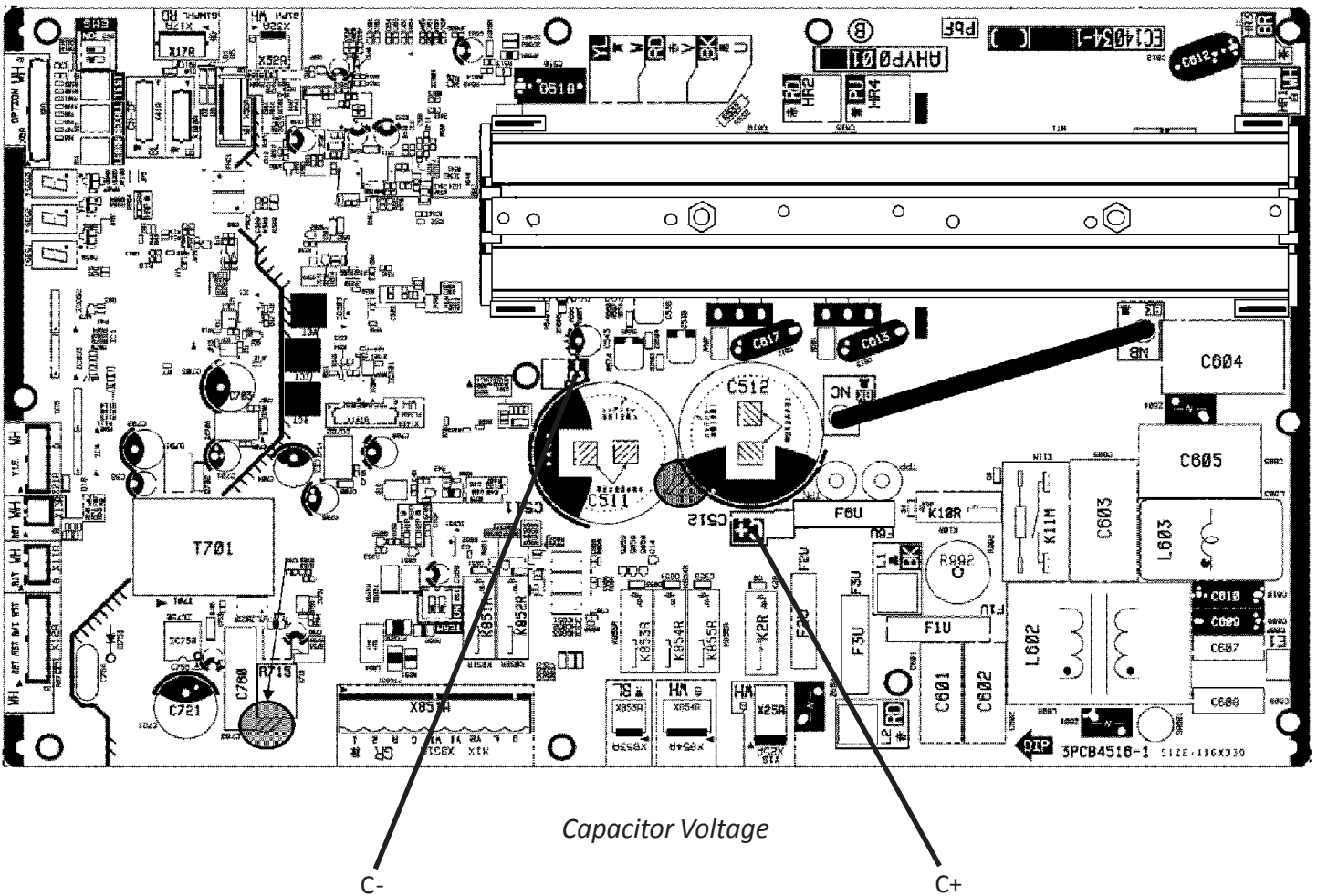

CAPACITOR

⚠ WARNING

AVOID CONTACT WITH THE CHARGED AREA.

• NEVER TOUCH THE CHARGED AREA BEFORE CONFIRMING THAT THE RESIDUAL VOLTAGE IS 50 VOLTS OR LESS.

1. SHUT DOWN THE POWER AND LEAVE THE CONTROL BOX FOR 10 MINUTES.
2. MAKE SURE TO TOUCH THE EARTH GROUND TERMINAL TO RELEASE THE STATIC ELECTRICITY FROM YOUR BODY (TO PREVENT FAILURE OF THE PC BOARD).
3. MEASURE THE RESIDUAL VOLTAGE IN THE SPECIFIED MEASUREMENT POSITION USING A VOM WHILE PAYING ATTENTION NOT TO TOUCH THE CHARGED AREA.
4. IMMEDIATELY AFTER MEASURING THE RESIDUAL VOLTAGE, DISCONNECT THE CONNECTORS OF THE OUTDOOR UNIT'S FAN MOTOR. (IF THE FAN BLADE ROTATES BY STRONG WIND BLOWING AGAINST IT, THE CAPACITOR WILL BE CHARGED, CAUSING THE DANGER OF ELECTRICAL SHOCK.)

4 - 5 TON

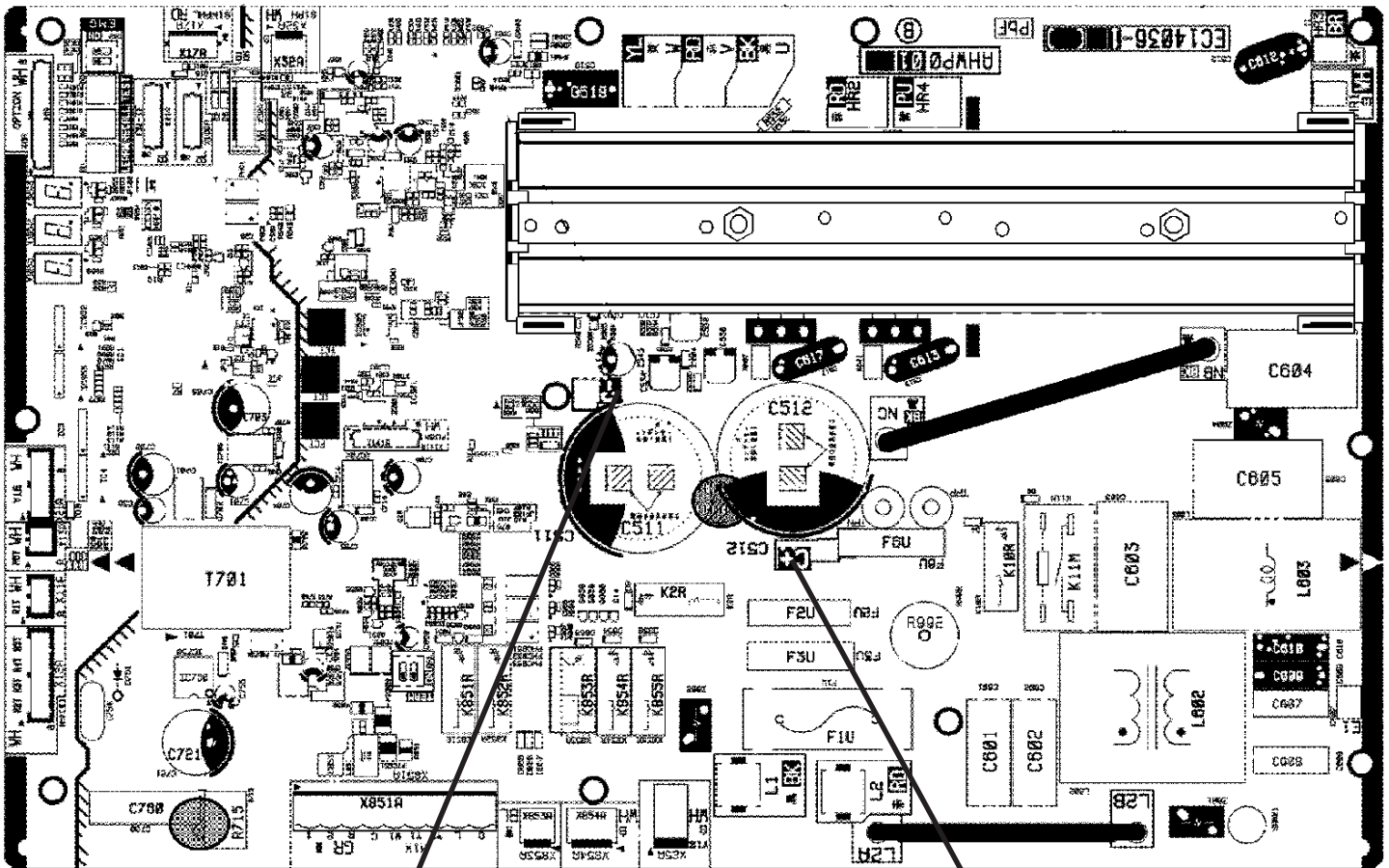

C-

Capacitor Voltage

C+

HEATING ANALYSIS CHART

POSSIBLE CAUSE X IN ANALYSIS GUIDE INDICATE "POSSIBLE CAUSE"	Comp discharge temp > 200F	Comp discharge temp < 105F	Comp discharge SH > 70F	Comp discharge SH < 20F	High pressure > 490psi	High pressure SSV < 270psi	High pressure LSV < 270psi	LSV SC > 12F	LSV SC < 4F	Low pressure < 40psi	Requested % demand < Actual %	Requested % demand > Actual %	Repeated stop/start	Weak heating	No switch heating	Noise	Incomplete defrost operation	Stop operation	Sweating liquid line
	Liquid stop valve does not fully open	X		X		X			X		X			X	X	X		X	
Gas stop valve does not fully open	X		X		X				X	X			X	X	X		X		
Line set restriction	X		X		X				X	X			X	X	X		X		X
Line set length is too long					X		X												X
Blocked filter-dryer	X		X		X				X	X			X	X	X		X		X
OD EEV coil failure	X	X	X	X	X	X	X	X	X	X	X	X	X	X	X		X	X	
OD EEV failure	X	X	X	X	X	X	X	X	X	X	X	X	X	X	X		X	X	
ID EEV coil failure	X		X		X		X		X	X	X	X	X	X	X		X	X	X
ID EEV failure	X		X		X		X		X	X	X	X	X	X	X		X	X	X
Check valve failure – Leakage		X		X					X		X		X	X				X	
High Pressure switch failure																		X	
Pressure sensor failure			X	X	X	X	X	X	X		X	X	X	X				X	
Suction temp sensor failure	X	X	X	X				X	X	X	X	X	X	X				X	
Discharge temp sensor failure	X	X	X	X							X	X	X	X				X	
Coil temp sensor failure										X			X	X	X			X	X
Defrost sensor failure										X			X	X	X			X	X
Liquid temp sensor failure								X	X									X	X
Ambient temp sensor failure					X					X			X	X	X			X	X
OD recirculation	X		X			X	X			X			X	X	X				
ID recirculation	X		X		X								X	X	X				
Dirty OD Heat-exchanger	X		X			X	X			X			X	X	X				
Dirty ID Heat-exchanger	X		X		X								X	X	X				
Outdoor Ambient temp is too high					X								X	X	X			X	X
Outdoor Ambient temp is too low	X	X	X			X	X		X	X			X	X	X				
ID suction temp is too high	X				X								X	X	X				
ID suction temp is too low						X	X												X
Mixture of non-condensable gas	X		X		X				X	X			X	X	X				
OD fan motor failure	X		X							X			X	X	X			X	
RV failure			X			X	X						X	X	X	X	X	X	
RV coil failure			X			X	X						X	X	X				
Over charge			X	X	X			X			X		X	X	X				X
Under charge	X	X	X			X	X		X	X			X	X					X
Leak	X	X	X			X	X		X	X			X	X					X
ID failure	X	X	X	X	X	X	X	X	X	X	X	X	X	X	X		X	X	X
OD Control Board failure																		X	
Compressor failure	X	X	X	X		X	X						X	X	X		X	X	X
Cooling loop is not attached													X	X	X				
Cooling loop grease is not enough													X	X	X				
Low ID CFM	X				X				X				X	X	X			X	

OD: 17-62F (-8.3-16.7C)

ID: 65-85F (18.3-29.4C)

⚠ WARNING

AVOID CONTACT WITH THE CHARGED AREA.

• NEVER TOUCH THE CHARGED AREA BEFORE CONFIRMING THAT THE RESIDUAL VOLTAGE IS 50 VOLTS OR LESS.

1. SHUT DOWN THE POWER AND LEAVE THE CONTROL BOX FOR 10 MINUTES.

2. MAKE SURE TO TOUCH THE EARTH GROUND TERMINAL TO RELEASE THE STATIC ELECTRICITY FROM YOUR BODY (TO PREVENT FAILURE OF THE PC BOARD).

3. MEASURE THE RESIDUAL VOLTAGE IN THE SPECIFIED MEASUREMENT POSITION USING A VOM WHILE PAYING ATTENTION NOT TO TOUCH THE CHARGED AREA.

4. IMMEDIATELY AFTER MEASURING THE RESIDUAL VOLTAGE, DISCONNECT THE CONNECTORS OF THE OUTDOOR UNIT'S FAN MOTOR. (IF THE FAN BLADE ROTATES BY STRONG WIND BLOWING AGAINST IT, THE CAPACITOR WILL BE CHARGED, CAUSING THE DANGER OF ELECTRICAL SHOCK.)

COOLING ANALYSIS CHART

POSSIBLE CAUSE X IN ANALYSIS GUIDE INDICATE "POSSIBLE CAUSE"	Comp discharge temp > 200F	Comp discharge temp < 105F	Comp discharge SH > 70F	Comp discharge SH < 20F	High pressure > 490psi	High pressure < 255psi	LSV SC > 12F	LSV SC < 4F	OD SSV SH > 20F	OD SSV SH < 4F	Low pressure > 185psi	Low pressure < 100psi	Requested % demand < Actual	Requested % demand > Actual	Repeated stop/start	Weak cooling	No switch cooling	Noise	Stop operation
	Liquid stop valve does not fully open	X		X		X		X		X			X		X	X	X		X
Gas stop valve does not fully open	X		X									X		X	X	X			
Line set restriction	X		X		X		X		X			X		X	X	X		X	
Line set length is too long									X			X			X	X		X	
Blocked filter-dryer	X		X		X		X		X			X		X	X	X		X	
OD EEV coil failure														X	X	X			X
OD EEV failure														X	X	X			
ID EEV coil failure	X	X	X	X	X	X	X	X	X	X	X	X	X	X	X	X			X
ID EEV failure	X	X	X	X	X	X	X	X	X	X	X	X	X	X	X	X			
Check valve failure – Blocked	X		X		X			X	X			X		X	X	X			
High Pressure switch failure																			X
Pressure sensor failure	X										X	X		X	X	X			X
Suction temp sensor failure													X	X		X			
Discharge temp sensor failure	X	X	X	X									X	X	X	X			X
Coil temp sensor failure				X	X	X							X	X	X	X			X
Defrost sensor failure																			
Liquid temp sensor failure																			
Ambient temp sensor failure				X	X	X							X	X	X	X			
OD recirculation	X		X		X									X	X	X		X	
ID recirculation		X		X					X			X	X	X	X	X			
Dirty OD Heat-exchanger	X		X		X									X	X	X		X	
Dirty ID Heat-exchanger		X		X				X	X			X	X	X	X	X			
Outdoor Ambient temp is too high	X		X		X				X					X	X	X		X	
Outdoor Ambient temp is too low		X		X		X	X					X	X	X	X	X			
ID suction temp is too high									X		X								
ID suction temp is too low		X		X				X	X			X	X	X	X	X			
Mixture of non-condensable gas	X		X		X			X	X			X		X	X	X		X	
OD fan motor failure	X		X		X			X						X	X	X		X	X
RV failure	X		X			X					X			X	X	X	X	X	X
RV coil failure	X		X			X					X			X	X	X	X	X	X
Over charge	X	X	X	X	X		X			X			X			X			X
Under charge	X	X	X			X		X	X			X				X		X	
Leak	X	X	X			X		X	X			X		X	X	X		X	
OD Control Board Failure																			X
ID Failure	X	X	X	X	X	X	X	X	X	X	X	X	X	X	X	X	X	X	X
Compressor failure	X	X	X			X					X			X	X	X		X	X
Cooling loop is not attached														X	X	X			
Cooling loop grease is not enough														X	X	X			
Low ID CFM		X		X						X		X	X	X	X	X			X

OD: 67-115F

ID: 65 - 85F

 **WARNING**

AVOID CONTACT WITH THE CHARGED AREA.

•NEVER TOUCH THE CHARGED AREA BEFORE CONFIRMING THAT THE RESIDUAL VOLTAGE IS 50 VOLTS OR LESS.

1. SHUT DOWN THE POWER AND LEAVE THE CONTROL BOX FOR 10 MINUTES.
2. MAKE SURE TO TOUCH THE EARTH GROUND TERMINAL TO RELEASE THE STATIC ELECTRICITY FROM YOUR BODY (TO PREVENT FAILURE OF THE PC BOARD).
3. MEASURE THE RESIDUAL VOLTAGE IN THE SPECIFIED MEASUREMENT POSITION USING A VOM WHILE PAYING ATTENTION NOT TO TOUCH THE CHARGED AREA.
4. IMMEDIATELY AFTER MEASURING THE RESIDUAL VOLTAGE, DISCONNECT THE CONNECTORS OF THE OUTDOOR UNIT'S FAN MOTOR. (IF THE FAN BLADE ROTATES BY STRONG WIND BLOWING AGAINST IT, THE CAPACITOR WILL BE CHARGED, CAUSING THE DANGER OF ELECTRICAL SHOCK.)

TROUBLESHOOTING

ClimateTalk Fault Code	PCB LED Display	Transmitted ClimateTalk Message	Thermostat Fault	Probable Causes	Corrective Actions
12	E12	OD CTRL FAIL1	Indicates a general memory error.	<ul style="list-style-type: none"> High electrical noise Faulty control board 	<ul style="list-style-type: none"> Replace control board if necessary
13	E13	HI PRESSURE C (C = CRITICAL)	This error indicates the equipment is experiencing frequent high pressure faults.	<ul style="list-style-type: none"> Blocked/restricted condenser coil and/or lines Stop valve not completely open Overcharge Outdoor fan not running High pressure switch (HPS) inoperable Faulty indoor EEV coil Faulty indoor EEV Faulty control board 	<ul style="list-style-type: none"> Check and clean condenser coil and/or lines Check the opening of stop valve, should be full open; Repair/replace if needed Check refrigerant charge level; Adjust if needed Check outdoor fan motor & wiring; Repair/replace if needed Check indoor EEV; Replace if needed Check indoor EEV coil; Replace if needed Replace control board if necessary
14	-	HI PRESSURE M (M = MINOR)	This error indicates the equipment is experiencing frequent high pressure faults. Control has determined continued operation is acceptable. This indicates they may be a problem with the equipment.	<ul style="list-style-type: none"> Blocked/restricted condenser coil and/or lines Stop valve not completely open Overcharge Outdoor fan not running High pressure switch (HPS) inoperable Faulty indoor EEV coil Faulty indoor EEV Faulty control board 	<ul style="list-style-type: none"> Check and clean condenser coil and/or lines Check the opening of stop valve, should be full open; Repair/replace if needed Check refrigerant charge level; Adjust if needed Check outdoor fan motor & wiring; Repair/replace if needed Check indoor EEV; Replace if needed Check indoor EEV coil; Replace if needed Replace control board if necessary
15	E15	LOW PRESSURE C	This error indicates the equipment is experiencing frequent low pressure faults.	<ul style="list-style-type: none"> Stop valve not completely open Restriction in refrigerant lines Low refrigerant charge Refrigerant leak Low pressure sensor inoperable or not properly connected Indoor fan motor not functioning correctly Faulty indoor EEV coil Faulty indoor EEV Faulty control board 	<ul style="list-style-type: none"> Check the opening of stop valve, should be full open; Repair/replace if needed Check for restrictions in refrigerant line; Repair/replace if needed Check refrigerant charge level; Adjust if needed Test for system leaks using leak test procedure Check the connection to low pressure sensor; Repair/replace if needed Check indoor EEV; Replace if needed Check indoor EEV coil; Replace if needed Check indoor blower motor & wiring; Repair/replace if needed Replace control board if necessary
16	-	LOW PRESSURE M	This error indicates the equipment is experiencing frequent low pressure faults. Control has determined continued operation is acceptable. This indicates they may be a problem with the equipment.	<ul style="list-style-type: none"> Stop valve not completely open Restriction in refrigerant lines Low refrigerant charge Refrigerant leak Low pressure sensor inoperable or not properly connected Indoor fan motor not functioning correctly Faulty indoor EEV coil Faulty indoor EEV Faulty control board 	<ul style="list-style-type: none"> Check the opening of stop valve, should be full open; Repair/replace if needed Check for restrictions in refrigerant line; Repair/replace if needed Check refrigerant charge level; Adjust if needed Test for system leaks using leak test procedure Check the connection to low pressure sensor; Repair/replace if needed Check indoor EEV; Replace if needed Check indoor EEV coil; Replace if needed Check indoor blower motor & wiring; Repair/replace if needed Replace control board if necessary
17	E17	COMPRESSOR FAIL	This error indicates the equipment is experiencing frequent compressor faults.	<ul style="list-style-type: none"> Stop valve not completely open The compressor wire is lost phase Compressor motor failure 	<ul style="list-style-type: none"> Check the opening of stop valve, should be full open; Repair/replace if needed Check the wire between control board and compressor Inspect compressor motor for proper function; Replace if necessary
20	E20	EEV OPEN CKT	EEV coil is not connected.	<ul style="list-style-type: none"> Outdoor EEV coil is not connected. Faulty outdoor EEV coil. 	<ul style="list-style-type: none"> Check outdoor EEV coil connection. Repair/replace as needed.
21	E21	EEV CTRL FAIL	This error indicates the equipment is experiencing frequent low discharge superheat faults.	<ul style="list-style-type: none"> Thermistors inoperable or improperly connected Faulty indoor EEV coil Faulty indoor EEV Faulty outdoor EEV coil Faulty outdoor EEV Over charge Faulty pressure sensor Faulty control board 	<ul style="list-style-type: none"> Check the connection to thermistors; Repair/replace if needed Check indoor EEV coil; Repair/replace if needed Check indoor EEV; Replace/repair if needed Check outdoor EEV coil; Repair/replace if needed Check outdoor EEV; Replace/repair if needed Check refrigerant charge level; Adjust if needed Check pressure sensor; Repair/replace if needed Replace control board if necessary

TROUBLESHOOTING

ClimateTalk Fault Code	PCB LED Display	Transmitted ClimateTalk Message	Thermostat Fault	Probable Causes	Corrective Actions
22	E22	HI DISCH TEMP	This error indicates the equipment is experiencing frequent high discharge temperature faults. Discharge thermistor is not put on correct position.	<ul style="list-style-type: none"> Discharge thermistor inoperable or improperly connected Discharge thermistor is put on incorrect position or off Low refrigerant charge Overcharge Faulty compressor 	<ul style="list-style-type: none"> Check discharge thermistor resistance and connections; Repair/replace as needed Check discharge thermistor position Check refrigerant charge level; Adjust if needed Check the compressor; Repair/replace if needed
23	E23	DISCH TEMP FAIL	The control has detected that the Discharge Temperature Sensor is out of range.	<ul style="list-style-type: none"> Discharge thermistor inoperable or improperly connected 	<ul style="list-style-type: none"> Check discharge thermistor resistance and connections; Repair/replace as needed
24	E24	HPS OPEN	The high pressure switch is open.	<ul style="list-style-type: none"> High pressure switch (HPS) inoperable 	<ul style="list-style-type: none"> Check resistance on HPS to verify operation; Replace if needed
25	E25	AIR SENSOR FLT	The outdoor air temperature sensor is open or shorted.	<ul style="list-style-type: none"> Faulty outdoor thermistor sensor or disconnect 	<ul style="list-style-type: none"> Inspect and test sensor; Replace sensor if needed
26	E26	PRESSURE SENSOR	The control determines that the pressure sensor is not reacting properly.	<ul style="list-style-type: none"> Low pressure sensor inoperable or not properly connected 	<ul style="list-style-type: none"> Check the connection to low pressure sensor; Repair/replace if needed
28	E28	COIL TEMP FAIL2	The control has detected that the Outdoor Coil Temperature Sensor is out of range.	<ul style="list-style-type: none"> Outdoor coil thermistor inoperable or not properly connected 	<ul style="list-style-type: none"> Check the connection to OD coil thermistor; Repair/replace if needed
29	E29	LIQ TEMP FAIL	The control has detected that the Liquid Temperature Sensor is out of range.	<ul style="list-style-type: none"> Liquid thermistor inoperable or not properly connected 	<ul style="list-style-type: none"> Check the connection to liquid thermistor; Repair/replace if needed
30	E30	OD CTRL FAIL3	Indicates the control board may need to be replaced.	<ul style="list-style-type: none"> Wiring to control board disconnected Faulty control board Noise 	<ul style="list-style-type: none"> Check wiring to control board; Repair as needed Replace control board if necessary
32	E32	HI TEMP CTRL1	This error indicates the equipment is experiencing high temperature faults on the outdoor control board.	<ul style="list-style-type: none"> Ambient air conditions too high Cooling bracket screw(s) missing or not properly fastened No or poor thermal grease coating between cooling plumbing and cooling bracket on control board No flow or limited flow through control board cooling circuit (potential restriction in line or low refrigerant) Stop valve not completely open 	<ul style="list-style-type: none"> Cycle power; re-try during usable ambient temperature range Verify cooling bracket screws in place and secure; Secure fasteners as needed Check thermal grease inside cooling bracket on control board; Apply additional grease as needed Check for restriction in line Check refrigerant charge level; Adjust if needed Check the opening of stop valve, should be full open; Repair/replace if needed
33	-	HI TEMP CTRL2	This error indicates the equipment is experiencing high temperature faults on the outdoor control board. Control has determined continued operation is acceptable. This indicates they may be a problem with the equipment.	<ul style="list-style-type: none"> Ambient air conditions too high Cooling bracket screw(s) missing or not properly fastened No or poor thermal grease coating between cooling plumbing and cooling bracket on control board No flow or limited flow through control board cooling circuit (potential restriction in line or low refrigerant) Stop valve not completely open 	<ul style="list-style-type: none"> Cycle power; re-try during usable ambient temperature range Verify cooling bracket screws in place and secure; Secure fasteners as needed Check thermal grease inside cooling bracket on control board; Apply additional grease as needed Check for restriction in line Check refrigerant charge level; Adjust if needed Check the opening of stop valve, should be full open; Repair/replace if needed
34	E34	CURRENT SPIKE	Board detected a high current condition. This indicates the potential for a short circuit.	<ul style="list-style-type: none"> Current spike in supply Stop valve not completely open The compressor wire is lost phase Faulty control board Faulty compressor 	<ul style="list-style-type: none"> Check power supply for in-rush current during start-up or steady state operation Check the opening of stop valve, should be full open; Repair/replace if needed Check the wire between control board and compressor Replace control board if necessary Check the compressor; Repair/replace if needed

TROUBLESHOOTING

ClimateTalk Fault Code	PCB LED Display	Transmitted ClimateTalk Message	Thermostat Fault	Probable Causes	Corrective Actions
35	E35	HIGH CURRENT	Board detected a high current condition.	<ul style="list-style-type: none"> Short circuit condition Stop valve not completely open Overcharge Faulty control board Faulty compressor 	<ul style="list-style-type: none"> Check installation clearances. Check the opening of stop valve, should be full open; Repair/replace if needed Check refrigerant charge level; Adjust if needed Replace control board if necessary Check the compressor; Repair/replace if needed.
36	E36	STARTUP ERROR	The control encountered an abnormal condition during the startup procedure.	<ul style="list-style-type: none"> Blocked/restricted condenser coil and/or lines The compressor wire is lost phase Inconsistent compressor load Faulty control board 	<ul style="list-style-type: none"> Check and clean condenser coil and/or lines Check the wire between control board and compressor Replace control board if necessary
37	E37	OD CTRL FAIL4	Indicates the control board may need to be replaced.	<ul style="list-style-type: none"> Faulty control board 	<ul style="list-style-type: none"> Replace control board if necessary
38	E38	COMP VOLTAGE	The control has detected a voltage related issue with the compressor.	<ul style="list-style-type: none"> High or low voltage from supply The compressor wire is lost phase Faulty control board 	<ul style="list-style-type: none"> Correct low/high line voltage condition; Contact local utility if needed Check the wire between control board and compressor Replace control board if necessary
39	E39	OD CTRL FAIL5	Indicates the control board may need to be replaced.	<ul style="list-style-type: none"> Thermistors inoperable or improperly connected Faulty control board 	<ul style="list-style-type: none"> Check the connection to thermistors; Repair/replace if needed Replace control board if necessary
40	E40	COMP MISMATCH	Control determines that its compressor requirement is different than the compressor capability.	<ul style="list-style-type: none"> Memory card not correct Control board mismatch 	<ul style="list-style-type: none"> Check memory card data vs. air conditioner model Verify control board size vs. air conditioner model; Replace control board if necessary
41	E41	LOW REFRIGERANT	The control has detected a low refrigerant condition.	<ul style="list-style-type: none"> Refrigerant leak Low refrigerant charge Thermistors inoperable or not properly connected 	<ul style="list-style-type: none"> Test for system leaks using leak test procedure Check refrigerant charge level; Adjust if needed Check the connection to thermistor; Repair/replace if needed
42	E42	LOW LINE VOLT	Control detects a low power supply voltage condition.	<ul style="list-style-type: none"> Low line voltage supply 	<ul style="list-style-type: none"> Check circuit breakers and fuses; Replace if needed Verify unit is connected to power supply as specified on rating plate Correct low line voltage condition; Contact local utility if needed
43	E43	HIGH LINE VOLT	Control detects a high power supply voltage condition.	<ul style="list-style-type: none"> High line voltage supply 	<ul style="list-style-type: none"> Verify unit is connected to power supply as specified on rating plate Correct high line voltage condition; Contact local utility if needed
44	E44	OP TEMP RANGE	The control detects the outdoor temperature outside recommended operational range. Unit may continue to operate normally.	<ul style="list-style-type: none"> Ambient air conditions too high or low 	<ul style="list-style-type: none"> Cycle power; re-try during usable ambient temperature range
45	E45	NO COOLING TEST	The control is unable to start the Cooling mode test because indoor heat has been turned on by thermostat. Please set thermostat to off position.	<ul style="list-style-type: none"> Heat provided by secondary heating source 	<ul style="list-style-type: none"> Turn off heater using thermostat before running AHRI mode
47	E47	NO SYS VER TEST	The control is unable to start the System Verification test because indoor heat has been turned on by thermostat. Please set thermostat to off position.	<ul style="list-style-type: none"> Heat provided by secondary heating source 	<ul style="list-style-type: none"> Turn off heater using thermostat before operation
48	E48	NO PUMP DOWN	The control is unable to enter the Pump Down Mode because indoor heat has been turned on by thermostat. Please set thermostat to off position.	<ul style="list-style-type: none"> Heat provided by secondary heating source 	<ul style="list-style-type: none"> Turn off heater using thermostat before operation
49	E49	NO CHARGE MODE	The control is unable to enter Charging Mode because indoor heat has been turned on by thermostat. Please set thermostat to off position.	<ul style="list-style-type: none"> Heat provided by secondary heating source 	<ul style="list-style-type: none"> Turn off heater using thermostat before operation
50	E50	LINE VOLT CTRL	This indicates there is a voltage issue on the control board. See service manual for troubleshooting information.	<ul style="list-style-type: none"> High or low voltage from supply Faulty control board 	<ul style="list-style-type: none"> Correct low/high line voltage condition; Contact local utility if needed Replace control board if necessary
51	E51	OD COMM ERROR	This indicates potential communication issues have been detected by the outdoor control board.	<ul style="list-style-type: none"> Communication wiring disconnected 	<ul style="list-style-type: none"> Check communication wiring; Repair as needed
52	-	COMP FAIL MINOR	This error indicates the equipment is experiencing frequent compressor faults. Control has determined continued operation is acceptable. This indicates they may be a problem with the equipment.	<ul style="list-style-type: none"> Stop valve not completely open The compressor wire is lost phase Compressor motor failure 	<ul style="list-style-type: none"> Check the opening of stop valve, should be full open; Repair/replace if needed Check the wire between control board and compressor Inspect compressor motor for proper function; Replace if necessary

TROUBLESHOOTING

ClimateTalk Fault Code	PCB LED Display	Transmitted ClimateTalk Message	Thermostat Fault	Probable Causes	Corrective Actions
54	-	EEV MINOR	This error indicates the equipment is experiencing frequent low discharge superheat faults. Control has determined continued operation is acceptable. This indicates they may be a problem with the equipment.	<ul style="list-style-type: none"> Thermistors inoperable or improperly connected Faulty indoor EEV or indoor EEV coil Faulty control board 	<ul style="list-style-type: none"> Check the connection to thermistors; Repair/replace if needed Check indoor EEV; Replace if needed Check indoor EEV coil; Replace if needed Replace control board if necessary
55	-	HI DIS TEMP MIN	This error indicates the equipment is experiencing frequent high discharge temperature faults. Control has determined continued operation is acceptable. This indicates they may be a problem with the equipment.	<ul style="list-style-type: none"> Discharge thermistor inoperable or improperly connected Discharge thermistor is put on incorrect position or off Low refrigerant charge Overcharge Faulty compressor 	<ul style="list-style-type: none"> Check discharge thermistor resistance and connections; Repair/replace as needed Check discharge thermistor position Check refrigerant charge level; Adjust if needed Check refrigerant charge level; Adjust if needed Check the compressor; Repair/replace if needed
56	E56	SUCT TEMP FAIL	The control has detected if the Outdoor Suction Temperature Sensor is out of range.	<ul style="list-style-type: none"> Suction thermistor inoperable or not properly connected 	<ul style="list-style-type: none"> Check the connection to suction thermistor; Repair/replace if needed
57	-	CL LOOP SWEAT	This indicates the control is sensing sweating on the cooling loop.	<ul style="list-style-type: none"> Refrigerant Leak Low refrigerant charge Faulty indoor EEV or indoor EEV coil Thermistors inoperable or improperly connection 	<ul style="list-style-type: none"> Test for system leaks using leak test procedure Check refrigerant charge level; Adjust if needed Check indoor EEV; Replace if needed Check indoor EEV coil; Replace if needed Check the connection to thermistors; Repair/replace if needed
B0	Eb0	NO ID AIRFLOW	The estimated airflow from indoor subsystem is near to 0 CFM.	<ul style="list-style-type: none"> Failed indoor blower motor Indoor fan motor not properly connected Too much static pressure 	<ul style="list-style-type: none"> Check ID fan motor wiring and connectors; Repair/replace if needed Check ID fan motor; Replace if needed
B9	Eb9	LOW ID AIRFLOW	Estimated airflow from motor is lower than the airflow requirement.	<ul style="list-style-type: none"> Failed indoor blower motor Indoor fan motor not properly connected Too much static pressure 	<ul style="list-style-type: none"> Check ID fan motor wiring and connectors; Repair/replace if needed Check ID fan motor; Replace if needed
D0	Ed0	NO NET DATA	Control board does not have the necessary data for it to properly perform its functions.	<ul style="list-style-type: none"> Air conditioner is wired as part of a communicating system and integrated control module does not contain any shared data. 	<ul style="list-style-type: none"> Replace control board if necessary
D1	Ed1	INVALID DATA	Control board does not the appropriate data needed to properly perform its functions.	<ul style="list-style-type: none"> Air conditioner is wired as part of a communicating system and integrated control module contains invalid shared data or network data is invalid for the integrated control module. 	<ul style="list-style-type: none"> Replace control board if necessary
D2	Ed2	SYSTEM MISMATCH	The airflow requirement is greater than the airflow capability of the indoor subsystem.	<ul style="list-style-type: none"> Air conditioner/heat pump is wired as part of a communicating system and outdoor unit requires airflow greater than indoor unit's airflow capability Shared data is incompatible the system or missing parameters Communication wiring has loose connection. Indoor unit without EEV. 	<ul style="list-style-type: none"> Verify shared data is correct for your specific model; Repopulate data if required Check communication wiring. Repair as needed.
Items below are messages only displayed on the thermostat screen.					
11	E11	RUN SYS TEST	This test is required at startup. Installer should navigate to the ComfortNet User Menu, choose Air Conditioner, then EQUIP TEST and SYSYTEM TEST. Selecting ON will run the required test. Display will clear once testing is complete.	<ul style="list-style-type: none"> Incomplete SYSTEM TEST SYSTEM TEST is running 	MESSAGE ONLY

TROUBLESHOOTING

NETWORK TROUBLESHOOTING

Communications is achieved by taking the difference between a positive dc signal and a negative dc signal. The positive dc signal is termed “data 1” or “1”. Data 1 is positive with respect to ground (or common). The negative dc signal is termed “data 2” or “2”. Data 2 is negative with respect to ground (or common).

Data 1 should be approximately 2.8 volts dc. Data 2 should be approximately 2.2 volts dc. The voltage difference between data 1 and data 2 should be approximately 0.6 volts dc.

Verify that the bus DS1 dip switches are in the ON position.

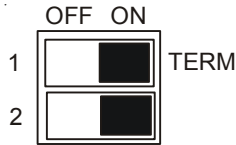

The ComfortNet™ system is a fully communicating system, constituting a network. Occasionally the need to troubleshoot the network may arise. The integrated control module has some on-board tools that can be used to troubleshoot the network. These tools are: red communications LED, green receive (Rx) LED, and the learn button.

- Red communications LED – Indicates the status of the network. The table below indicates the LED status and the corresponding potential problem.
- Green receive LED – Indicates network traffic. The table below indicates the LED status and the corresponding potential problem.
- LEARN button – Used to reset the network. Depress the button for approximately 5 seconds to reset the network.

LED COLOR	LED Status	Indication	Probable Causes	Corrective Actions
Red Communications LED (H1P)	Off	Nominal condition	• None	• none
	1 Flash	Communications Failure	• Unknown packet is received	• Depress learn button
	2 Flash	Out-of-box reset	• Control power up • Learn button depressed	• None
Green Receive LED (H2P)	Off	No power Communications error	• No power to Outdoor unit • Open fuse • Communication error	• Check circuit breakers and fuses; Replace if needed • Reset network by depressing learn button • Check communication wires (data 1/ data 2 wires); Replace if needed
	1 Steady Flash	No network found	• Broken/ disconnected communication wire(s) • AC is installed as a legacy/ traditional system	• Check communication wires (data 1/ data 2 wires); Replace if needed • Check installation type (legacy/ traditional or communicating) • Check data 1/ data 2 voltages
	Rapid Flashing	Nominal network traffic	• Control is "talking" on network as expected	• none
	On Solid	Data 1/Data 2 miss-wire	• Data 1 and data 2 wires reversed at indoor unit, thermostat, or outdoor unit • Short between data 1 and data 2 wires • Short between data 1 or data 2 wires	• Check communication wires (data 1/ data 2 wires); Replace if needed • Check data 1/ data 2 voltages

SETTING THE MODE DISPLAY

MODE DISPLAY INTRODUCTION

A 3-digit display is provided on the printed circuit board (PCB) as a backup tool to the thermostat for reading faults, fault history, monitoring and setting up the condensing unit. Follow the information provided in this section to learn how to use the mode display.

DISPLAY

The display consists of 3 digits.

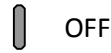
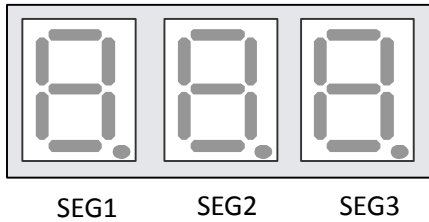

OFF



ON



Blink interval: 0.4 sec. On - 0.4 sec. Off

DISPLAY BUTTON LAYOUT

The display buttons shown can be used to navigate and select items:

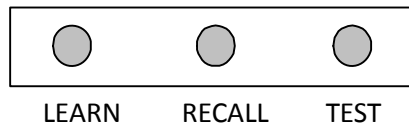

*Examples of button layout are shown above.
Identify correct display buttons on your unit PCB.*

MODES

There are 5 modes which can be accessed using the setting display:
FAULT CODE, FAULT HISTORY, MONITORING, SETTING MODE 1 and SETTING MODE 2.

To enter any of these modes, use the schemes shown in this section. Each mode has its own corresponding "Screen #" within the display itself which allows the user to navigate and use the features. (Example: The Fault Code is accessed and displayed from "Screen Zero" of the 7-segment display. The Fault History is accessed and display using "Screen One" of the display, etc.)

MODE	FUNCTION	DISPLAY SCREEN #
<i>Fault Code Display</i>	Present fault (if any).	0 (Default)
<i>Fault Code History</i>	6 Recent faults stored.	1
<i>Monitoring Mode</i>	*Monitors system values.	2
<i>Setting Mode 1</i>	*Can change system settings	3
<i>Setting Mode 2</i>	*Can change system settings.	4

**See tables at the end of this section.*

NAVIGATING THROUGH THE DISPLAY SCREENS

SCREEN ZERO The home or default screen on the display. This shows the most recent fault.

SCREEN ONE To access, hold the RECALL button from screen zero - 5 seconds.

SCREEN TWO To access, hold the RECALL button from screen one - 5 seconds.

SCREEN THREE To access, hold the RECALL button from screen two - 5 seconds.

SCREEN FOUR To access, hold the RECALL and TEST buttons simultaneously - 5 seconds.

To return to SCREEN ZERO of the display, press the LEARN button

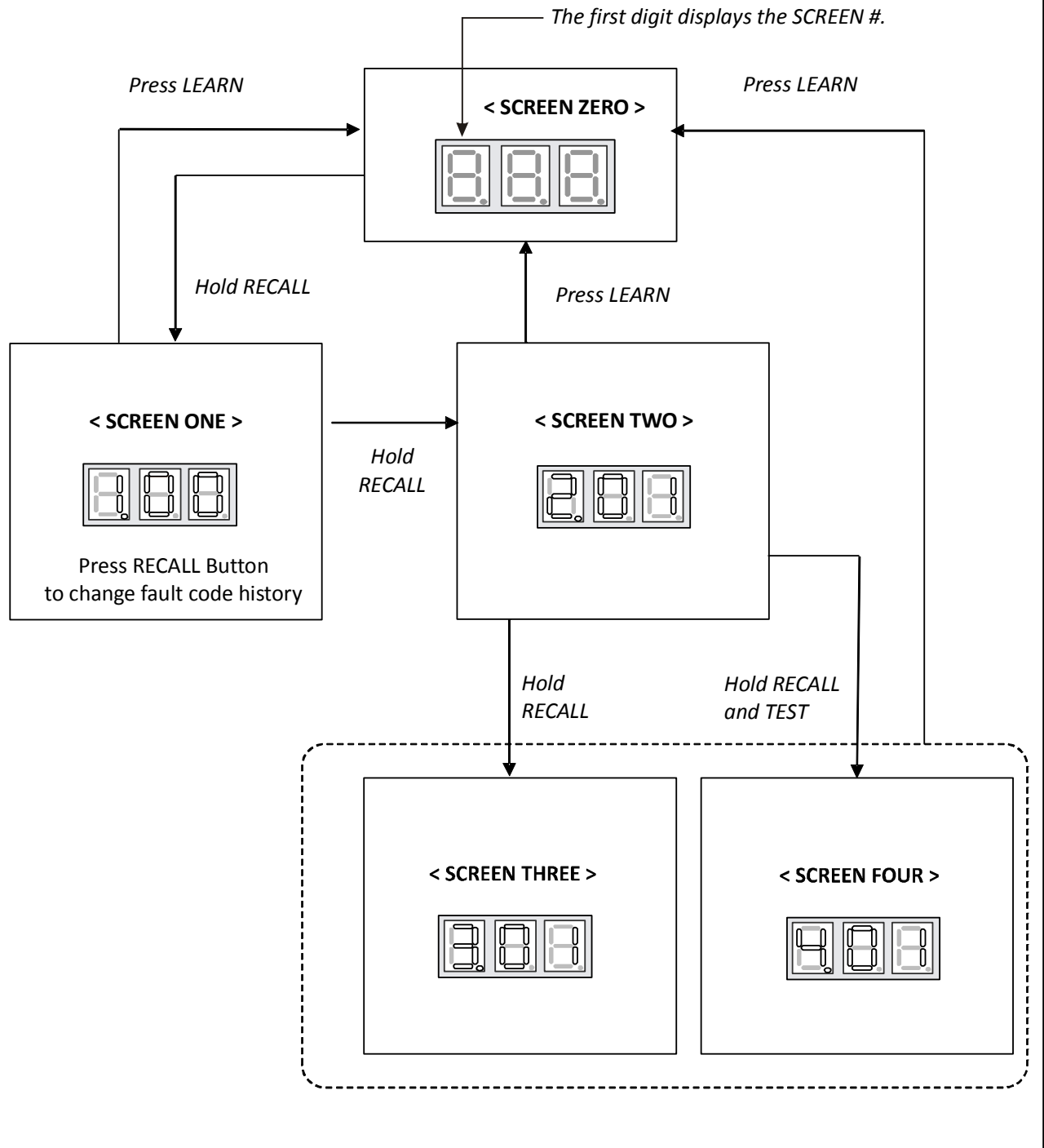

FAULT CODE HISTORY NAVIGATION

< SCREEN ONE >

This mode will allow the user to see the six most recent system faults.
For a list of the fault codes, please see the TROUBLESHOOTING tables in this document.

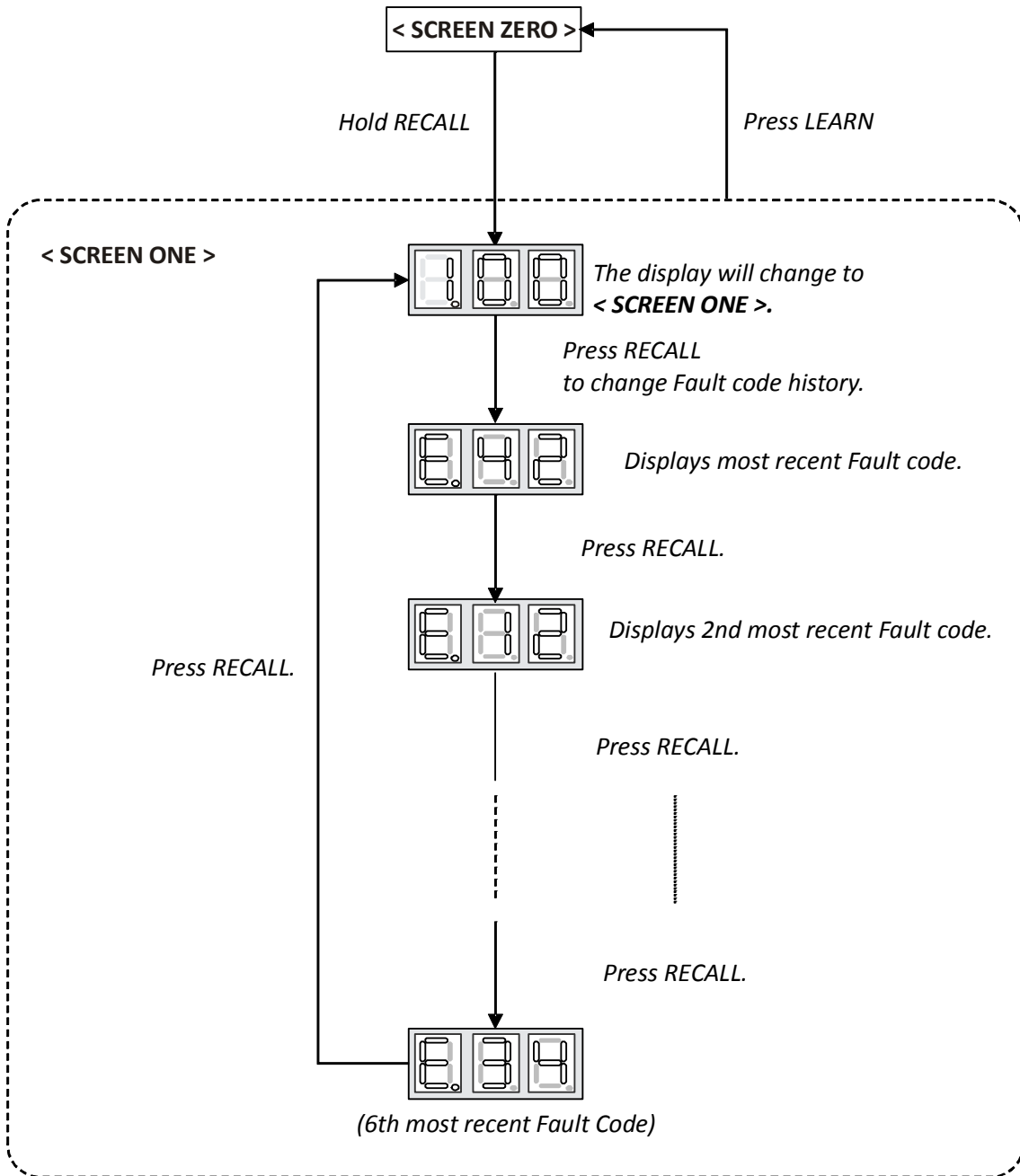

SETTING THE MODE DISPLAY

MONITORING MODE NAVIGATION

< SCREEN TWO >

This screen allows the user to monitor system variables as shown in the tables at the end of this section.

< SCREEN ZERO >

OFF

ON



Blink interval:
0.4 sec. On - 0.4 sec. Off

< SCREEN ONE >

Hold **RECALL**

Press **LEARN**

< SCREEN TWO >

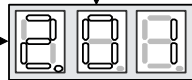

Press **RECALL**
to increase the value.

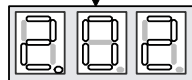

Press **RECALL**.



Press **RECALL**.

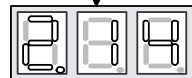

Press **TEST**
to confirm the setting.

Item number

Display flickers at 1 second intervals.

Value

Press **RECALL**.

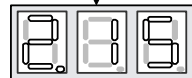

Press **RECALL**.

Press **RECALL**

SETTING THE MODE DISPLAY

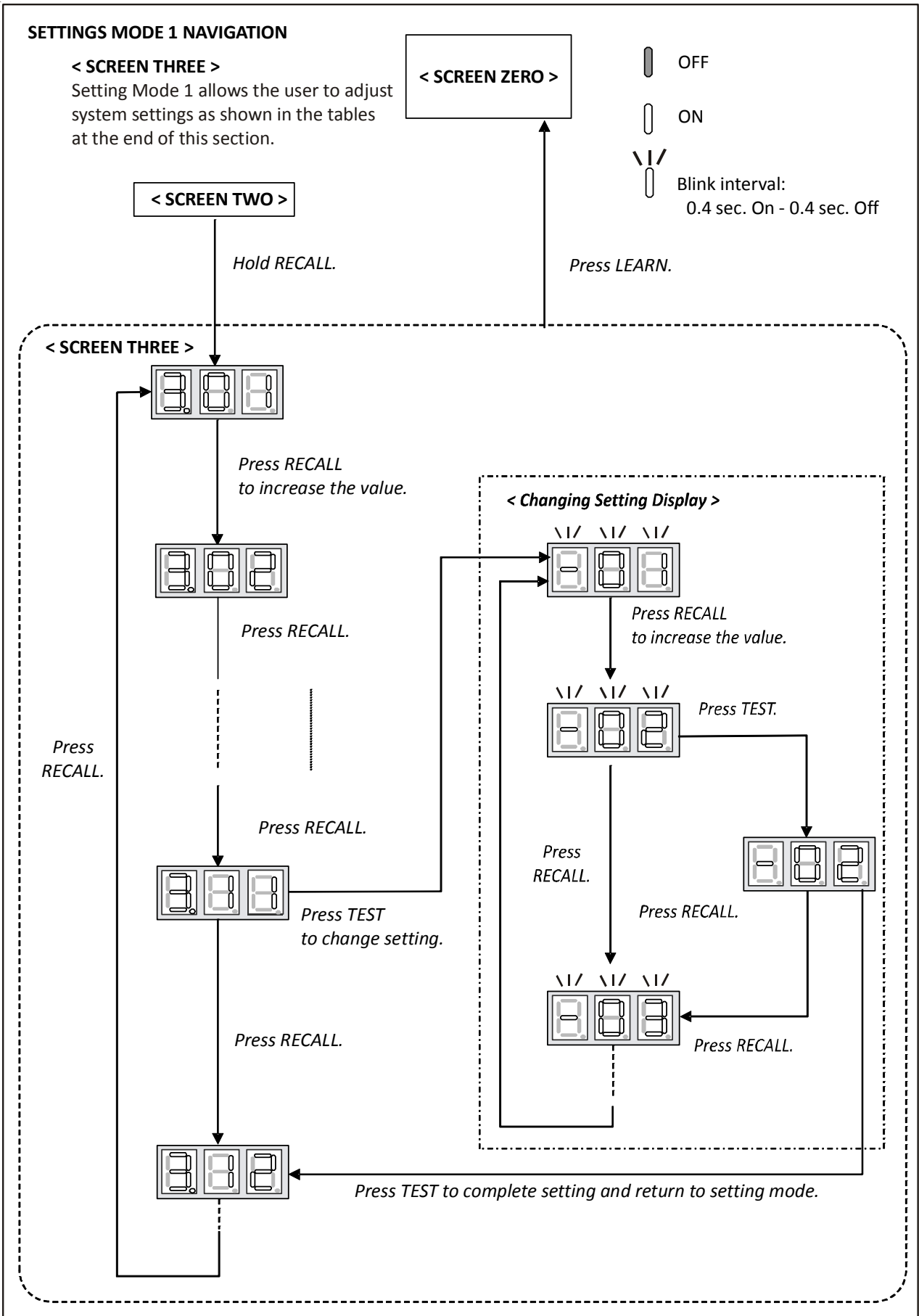

SETTING THE MODE DISPLAY

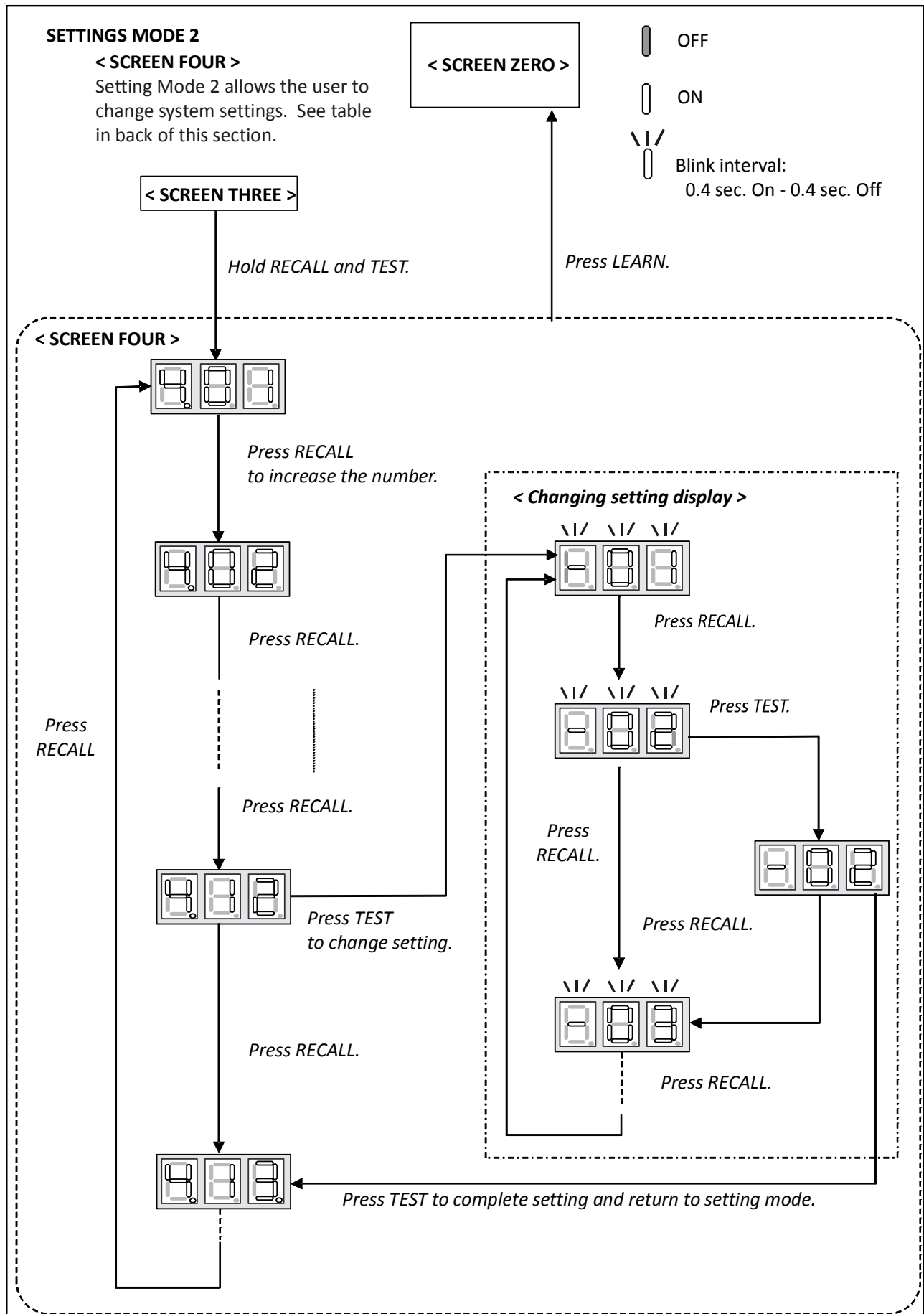

7-SEGMENT DISPLAY

SCREEN 0 (Display FAULT CODE)

Setting No.	Contents	Notes
1	Fault code (present)	

SCREEN 1 (Display FAULT CODES)

Setting No.	Contents	Notes
1	Fault code (latest)	Latest
2	Fault code (2nd)	2nd
3	Fault code (3rd)	3rd
4	Fault code (4th)	4th
5	Fault code (5th)	5th
6	Fault code (6th)	6th

SCREEN 2 (MONITOR MODE)

Setting No.	Contents	Notes
1	Compressor operation time	unit : hr (Multiply by 200.)
2	Operation code	0: Stop 1: Cooling Start-up 2: Heating Start-up 3: Oil Return Operation 4: Heating Operation 5: Defrost Operation 6: Cooling Operation
3	Compressor Reduction Mode	0:OFF,1:ON
4	% demand	unit : % (Cut off the decimal first place.)
5	act % demand	unit : % (Cut off the decimal first place.)
6	Requested ID CFM	unit : CFM (Multiply by 10)
7	Reported ID CFM	unit : CFM (Multiply by 10)
8	Outdoor FAN TAP	0: Off; 1: Low Tap; 2: Medium Tap; 3: High Tap
9	Ta (Outdoor Air Temperature)	unit : F
10	Td (Discharge Temperature)	unit : F
11	Tm (Outdoor Coil Temperature)	unit : F
12	Tb (Defrost Sensor Temperature)	unit : F
13	Tl (Liquid Temperature)	unit : F
14	Pressure Sensor	unit : PSI
15	Ts (Suction Temperature)	unit : F

7-Segment Display

SCREEN 3 (SETTING MODE 1)

Setting No.	Contents	Setting			Installer/Service Man Notes
1	Cool Airflow Trim High	0:-15% 1:-12% 2:-9% 3:-6% 4:-3%	<u>5:0%</u> 6:3% 7:6%	8:9% 9:12% 10:15%	
2	Cool Airflow Trim Int	0:-15% 1:-12% 2:-9% 3:-6% 4:-3%	<u>5:0%</u> 6:3% 7:6%	8:9% 9:12% 10:15%	
3	Cool Airflow Trim Low	0:-15% 1:-12% 2:-9% 3:-6% 4:-3%	<u>5:0%</u> 6:3% 7:6%	8:9% 9:12% 10:15%	
4	Cool Profile	0:A 1:B	2:C	<u>3:D</u>	
5	Cool ON Delay	<u>0:5sec.</u> 1:10sec.	2:20sec.	3:30sec.	
6	Cool OFF Delay	<u>0:30sec.</u> 1:60sec.	2:90sec.	3:120sec.	
7	Dehumidification Select	<u>0:ON</u>	1:OFF		
8	Heat Airflow Trim High	0:-15% 1:-12% 2:-9% 3:-6% 4:-3%	<u>5:0%</u> 6:3% 7:6%	8:9% 9:12% 10:15%	
9	Heat Airflow Trim Int	0:-15% 1:-12% 2:-9% 3:-6% 4:-3%	<u>5:0%</u> 6:3% 7:6%	8:9% 9:12% 10:15%	
10	Heat Airflow Trim Low	0:-15% 1:-12% 2:-9% 3:-6% 4:-3%	<u>5:0%</u> 6:3% 7:6%	8:9% 9:12% 10:15%	
11	Heat ON Delay	<u>0:5sec.</u>	1:10sec.	2:15sec.	
12	Heat OFF Delay	<u>0:30sec.</u> 1:50sec.	2:70sec.	3:90sec.	

7-SEGMENT DISPLAY

SCREEN 4 (SETTING MODE 2)

Setting No.	Contents	Setting	Installer/Service Man Notes
1	Maximum Defrost Interval	0: 30min. 1: 60min. 2: 90min. 3: 120min.	
2	Set Maximum Current	N/A	Future Use
3	Vertical Rise	0:Same Level <u>1:Outdoor Lower</u> 2:Indoor Lower	
4	System Verification Test	0:ON <u>1:OFF</u>	
7	Force Defrost Cycle	0:ON <u>1:OFF</u>	
8	Pump Down	0:ON <u>1:OFF</u>	
9	Charge Mode	0:ON <u>1:OFF</u>	
10	Maximum Compressor RPS for Cooling	*	
11	Maximum Compressor RPS for Heating	*	
12	BOOST MODE Selection	<u>0:ON</u> 1:OFF	
13	BOOST MODE Temperature	<u>0:105F</u> , 1:100F, 2:95F, 3:90F, 4:85F, 5:80F, 6:75F, 7:70F, 8:Always ON	

* See service manual for detailed information.

NOTE: Parameters as per factory setting are highlighted in bold and underlined.

SPLIT SYSTEMS

AIR CONDITIONING AND HEAT PUMP HOMEOWNER'S ROUTINE MAINTENANCE RECOMMENDATIONS

*We strongly recommend a bi-annual maintenance checkup be performed before the heating and cooling seasons begin by a **qualified servicer**.*

REPLACE OR CLEAN FILTER

IMPORTANT NOTE: Never operate unit without a filter installed as dust and lint will build up on internal parts resulting in loss of efficiency, equipment damage and possible fire.

An indoor air filter must be used with your comfort system. A properly maintained filter will keep the indoor coil of your comfort system clean. A dirty coil could cause poor operation and/or severe equipment damage.

Your air filter or filters could be located in your furnace, in a blower unit, or in "filter grilles" in your ceiling or walls. The installer of your air conditioner or heat pump can tell you where your filter(s) are, and how to clean or replace them.

Check your filter(s) at least once a month. When they are dirty, replace or clean as required. Disposable type filters should be replaced. Reusable type filters may be cleaned.

You may want to ask your dealer about high efficiency filters. High efficiency filters are available in both electronic and non-electronic types. These filters can do a better job of catching small airborne particles.

COMPRESSOR

The compressor motor is hermetically sealed and does not require additional oiling.

MOTORS

Indoor and outdoor fan motors are permanently lubricated and do not require additional oiling.

CLEAN OUTSIDE COIL (QUALIFIED SERVICER ONLY)

WARNING

HIGH VOLTAGE!

**DISCONNECT ALL POWER BEFORE SERVICING.
MULTIPLE POWER SOURCES MAY BE PRESENT.
FAILURE TO DO SO MAY CAUSE PROPERTY DAMAGE,
PERSONAL INJURY OR DEATH.**



Air must be able to flow through the outdoor unit of your comfort system. Do not construct a fence near the unit or build a deck or patio over the unit without first discussing your plans with your dealer or other qualified servicer. Restricted airflow could lead to poor operation and/or severe equipment damage.

Likewise, it is important to keep the outdoor coil clean. Dirt, leaves, or debris could also restrict the airflow. If cleaning of the outdoor coil becomes necessary, hire a qualified servicer. Inexperienced people could easily puncture the tubing in the coil. Even a small hole in the tubing could eventually cause a large loss of refrigerant. Loss of refrigerant can cause poor operation and/or severe equipment damage.

Do not use a condensing unit cover to "protect" the outdoor unit during the winter, unless you first discuss it with your dealer. Any cover used must include "breathable" fabric to avoid moisture buildup.

BEFORE CALLING YOUR SERVICER

- Check the thermostat to confirm that it is properly set.
- Wait 15 minutes. Some devices in the outdoor unit or in programmable thermostats will prevent compressor operation for awhile, and then reset automatically. Also, some power companies will install devices which shut off air conditioners for several minutes on hot days. If you wait several minutes, the unit may begin operation on its own.
- Check the electrical panel for tripped circuit breakers or failed fuses. Reset the circuit breakers or replace fuses as necessary.
- Check the disconnect switch near the indoor furnace or blower to confirm that it is closed.
- Check for obstructions on the outdoor unit. Confirm that it has not been covered on the sides or the top. Remove any obstruction that can be safely removed. If the unit is covered with dirt or debris, call a qualified servicer to clean it.
- Check for blockage of the indoor air inlets and outlets. Confirm that they are open and have not been blocked by objects (rugs, curtains or furniture).
- Check the filter. If it is dirty, clean or replace it.
- Listen for any unusual noise(s), other than normal operating noise, that might be coming from the outdoor unit. If you hear unusual noise(s) coming from the unit, call a qualified servicer.



CAUTION

TO AVOID THE RISK OF EQUIPMENT DAMAGE OR FIRE, INSTALL THE SAME AMPERAGE BREAKER OR FUSE AS YOU ARE REPLACING. IF THE CIRCUIT BREAKER OR FUSE SHOULD OPEN AGAIN WITHIN THIRTY DAYS, CONTACT A QUALIFIED SERVICER TO CORRECT THE PROBLEM. IF YOU REPEATEDLY RESET THE BREAKER OR REPLACE THE FUSE WITHOUT HAVING THE PROBLEM CORRECTED, YOU RUN THE RISK OF SEVERE EQUIPMENT DAMAGE.



Start-up Checklist For Unitary Inverter

**Store in job file*

Date: _____

Model Number: _____

Serial Number: _____

Technician: _____

Pre Start-Up

(Check each item as completed)

- Verify all packaging material has been removed.
- Remove all shipping brackets per installation instructions.
- Verify the job site voltage agrees with the unit serial plate.
- Verify condensate connection is installed per installation instructions.
- Verify proper clearance around the unit for safety, service, maintenance and proper unit operation.
- Verify proper weatherproofing of all ductwork, roof curbs and electrical connections.
- Check gas piping for leaks.
- Verify gas pressure to the unit is within the range specified on the serial plate.
- Check to ensure that all fan blades and wheels are secure.
- Check refrigerant piping for rubbing and leaks. *Repair if necessary.*
- Check unit wiring to ensure it is not in contact with refrigerant piping or sharp metal edges.
- Check all electrical connections and terminals. *Tighten as needed.*
- Verify that the crankcase heaters have been energized for 24 hours.
- Verify all accessories are installed and operating correctly.
- Check filters and replace if necessary.
- Verify the installation of the thermostat. The CTK04 is the only approved thermostat for the unitary inverter unit.

3/2015



Start-up Checklist For Unitary Inverter

Start-Up
(Insert the values as each item is completed.)

ELECTRICAL

Supply Voltage	L1 - L2	_____
Compressor Amps		_____
Blower Amps		_____
Condenser Fan Amps	Fan	_____

BLOWER EXTERNAL STATIC PRESSURE

Return Air Static Pressure	_____	IN. W.C.
Supply Air Static Pressure	_____	IN. W.C.
Total External Static Pressure	_____	IN. W.C.
Air Flow	_____	CFM

TEMPERATURES

Outdoor Air Temperature	_____	DB	_____	WB
Return Air Temperature	_____	DB	_____	WB
Cooling Supply Air Temperature	_____	DB	_____	WB
Heating Supply Air Temperature	_____	DB	_____	

PRESSURES

Gas Inlet Pressure	_____	IN. W.C.	
Gas Manifold Pressure	_____	IN. W.C. (Low Fire)	_____ IN. W.C. (High Fire)
Suction Circuit	_____	PSIG	_____ °F
Superheat / Subcooling	_____		_____ °F
Discharge Circuit	_____	PSIG	_____ °F

(HEAT PUMP ONLY)

Suction Circuit	_____	PSIG	_____ °F
Discharge Circuit	_____	PSIG	_____ °F

Start-Up
(Fill in the blanks from the Status Screen on the CTK04 Thermostat)

...ComfortNet User Menu > Heat Pump > Status

<div style="border: 1px solid black; padding: 2px; width: 80px; margin: 5px auto;">Previous Menu</div> <div style="border: 1px solid black; padding: 2px; width: 80px; margin: 5px auto;">Help</div>	<p>TS: _____ hr</p> <p>MD: Cooling</p> <p>CRM: _____</p> <p>RAD: _____ %, _____ %</p> <p>RAF: _____ CFM, _____ CFM</p> <p>OF: _____ F, _____ TAP</p> <p>DCT _____ F, _____ F</p> <p>DLT _____ F, _____ F</p> <p>PSDST: _____ PSI _____ F</p>	<div style="border: 1px solid black; border-radius: 50%; width: 60px; height: 60px; margin: 10px auto; display: flex; align-items: center; justify-content: center;"> <div style="border: 1px solid black; border-radius: 50%; width: 40px; height: 40px; margin: 5px auto; display: flex; align-items: center; justify-content: center;">▲</div> </div> <div style="border: 1px solid black; border-radius: 50%; width: 60px; height: 60px; margin: 10px auto; display: flex; align-items: center; justify-content: center;"> <div style="border: 1px solid black; border-radius: 50%; width: 40px; height: 40px; margin: 5px auto; display: flex; align-items: center; justify-content: center;">▼</div> </div>
--	--	---

THIS PAGE LEFT INTENTIONALLY BLANK

CUSTOMER FEEDBACK

We are very interested in all product comments.
Please fill out the feedback on one of the following links:
Amana® Brand Products: (<http://www.amana-hac.com/about-us/contact-us>).
You can also scan the QR code on the right for the product brand
you purchased to be directed to the feedback page.



Product Registration

Thank you for your recent purchase. Though not required to get the protection of the standard warranty, registering your product is a relatively short process, and entitles you to additional warranty protection, except that failure by California and Quebec residents to register their product does not diminish their warranty rights.

For Product Registration please register by following this link:
Amana® Brand Products: (<http://www.amana-hac.com/product-registration>).
You can also scan the QR code on the right to be directed to the Product Registration Page.



NOTE: SPECIFICATIONS AND PERFORMANCE DATE LISTED HEREIN ARE SUBJECT TO CHANGE WITHOUT NOTICE.

Visit our website at www.amana-hac.com for information on:

- Products
- Warranties
- Customer Services
- Parts
- Contractor Programs and Training
- Financing Options

Goodman Manufacturing Company, L.P.
5151 San Felipe, Suite 500 • Houston, TX 77056

©2016, 2018