

*MES80/*CES80

GAS FURNACE - CATEGORY 1

CATÉGORIE I

These furnaces comply with requirements embodied in the American National Standard / National Standard of Canada ANSI Z21.47·CSA-2.3 Gas Fired Central Furnaces.



Installer: Affix all manuals adjacent to the unit.

Intertek

ATTENTION INSTALLING PERSONNEL

As a professional installer, you have an obligation to know the product better than the customer. This includes all safety precautions and related items.

Prior to actual installation, thoroughly familiarize yourself with this Instruction Manual. Pay special attention to all safety warnings. Often during installation or repair, it is possible to place yourself in a position which is more hazardous than when the unit is in operation.

Remember, it is **your** responsibility to install the product safely and to know it well enough to be able to instruct a customer in its safe use.

Safety is a matter of common sense...a matter of thinking before acting. Most dealers have a list of specific, good safety practices...follow them.

The precautions listed in this Installation Manual are intended as supplemental to existing practices. However, if there is a direct conflict between existing practices and the content of this manual, the precautions listed here take precedence.

RECOGNIZE THIS SYMBOL AS A SAFETY PRECAUTION

NOTE: Please contact your distributor or our website listed below for the applicable Specification Sheet referred to in this manual.

PROP 65 WARNING FOR CALIFORNIA CONSUMERS
 WARNING
Cancer and Reproductive Harm - www.P65Warnings.ca.gov
0140M00517-A

INDEX

SAFETY CONSIDERATIONS..... 3
 Additional Safety Considerations..... 4
 Shipping Inspection..... 4
 Electrostatic Discharge (ESD) Precautions..... 5
 To The Installer..... 5
 PRODUCT APPLICATION..... 5
 LOCATION REQUIREMENTS AND CONSIDERATIONS .6
 Clearances and Accessibility..... 7
 Installation Positions..... 7
 Horizontal Installation..... 8
 Furnace Suspension..... 8
 Existing Furnace Removal..... 8
 Thermostat Location..... 9
 COMBUSTION AND VENTILATION AIR REQUIREMENTS9
 CATEGORY I VENTING (VERTICAL VENTING)..... 10

WARNING

ONLY PERSONNEL THAT HAVE BEEN TRAINED TO INSTALL, ADJUST, SERVICE OR REPAIR (HEREINAFTER, "SERVICE") THE EQUIPMENT SPECIFIED IN THIS MANUAL SHOULD SERVICE THE EQUIPMENT. THE MANUFACTURER WILL NOT BE RESPONSIBLE FOR ANY INJURY OR PROPERTY DAMAGE ARISING FROM IMPROPER SERVICE OR SERVICE PROCEDURES. IF YOU SERVICE THIS UNIT, YOU ASSUME RESPONSIBILITY FOR ANY INJURY OR PROPERTY DAMAGE WHICH MAY RESULT. IN ADDITION, IN JURISDICTIONS THAT REQUIRE ONE OR MORE LICENSES TO SERVICE THE EQUIPMENT SPECIFIED IN THIS MANUAL, ONLY LICENSED PERSONNEL SHOULD SERVICE THE EQUIPMENT. IMPROPER INSTALLATION, ADJUSTMENT, SERVICING OR REPAIR OF THE EQUIPMENT SPECIFIED IN THIS MANUAL, OR ATTEMPTING TO INSTALL, ADJUST, SERVICE OR REPAIR THE EQUIPMENT SPECIFIED IN THIS MANUAL WITHOUT PROPER TRAINING MAY RESULT IN PRODUCT DAMAGE, PROPERTY DAMAGE, PERSONAL INJURY OR DEATH.

19001 Kermier Rd.
Waller, TX 77484

IOG-2021D
03/2020

www.goodmanmfg.com • www.amana-hac.com
© 2019 - 2020 Goodman Manufacturing Company, L.P.

Amana® is a registered trademark of Maytag Corporation or its related companies and is used under license. All rights reserved.



MASONRY CHIMNEYS	11	Igniter (Qualified Servicer Only).....	24
Masonry Chimney Termination.....	11	Burners.....	24
ELECTRICAL CONNECTIONS.....	11	CLEANING (QUALIFIED SERVICER ONLY).....	24
Wiring Harness.....	12	BEFORE LEAVING AN INSTALLATION.....	25
115 Volt Line Connections.....	12	REPAIR AND REPLACEMENT PARTS.....	25
Fossil Fuel Applications.....	12	Component ID.....	26
Junction Box Relocation.....	12	Troubleshooting Chart.....	27
24 Volt Thermostat Wiring.....	13	TROUBLESHOOTING CHART	
115 Volt Line Connection of Accessories.....	13	PCBBF145 CONTROL BOARD.....	27
24 Vac Humidifier.....	13	BLOWER PERFORMANCE DATA.....	30
Twinning.....	14	DC80SE.....	30
GAS SUPPLY AND PIPING.....	14	DM80SE.....	32
High Altitude Derate.....	14	DM80SE / DC80SE Wiring Diagram.....	36
Propane Gas Conversion.....	14		
Gas Piping Connections.....	15		
Upflow Installations.....	16		
Counterflow Installations.....	16		
Gas Piping Checks	16		
Propane Gas Tanks and Piping.....	17		
DUCTWORK	17		
Filters - Read This Section Before			
Installing The Return Air Ductwork.....	17		
SEQUENCE OF OPERATION			
(INTEGRATED IGNITION CONTROL)	18		
Power Up.....	18		
Heating Mode.....	18		
(Mode DIP switch is set to "1 STG" position).....	18		
Cooling Mode.....	18		
Fan Only Mode.....	18		
START-UP PROCEDURE AND ADJUSTMENT.....	19		
Furnace Operation.....	19		
Furnace Start-up.....	19		
Furnace Shutdown.....	19		
Gas Supply Pressure Measurement.....	19		
Gas Manifold Pressure Measurement			
and Adjustment.....	20		
Gas Input Rate Measurement (Natural Gas Only).....	21		
Temperature Rise.....	21		
Circulator Blower Speed Adjustment.....	22		
OPERATIONAL CHECKS.....	22		
Checking Duct Static.....	22		
Burner Flame.....	22		
SAFETY CIRCUIT DESCRIPTION.....	23		
General.....	23		
Integrated Control Module.....	23		
Primary Limit.....	23		
Auxiliary Limit.....	23		
Rollout Limits.....	23		
Pressure Switches.....	23		
Flame Sensor.....	23		
TROUBLESHOOTING.....	23		
Diagnostic Chart.....	23		
Resetting From Lockout.....	23		
MAINTENANCE.....	23		
Annual inspection.....	23		
Filters.....	24		
Filter Maintenance.....	24		
Filter Removal.....	24		
Induced Draft and Circulator Blower Motors.....	24		
Flame Sensor (Qualified Servicer Only).....	24		

SAFETY CONSIDERATIONS

Adhere to the following warnings and cautions when installing, adjusting, altering, servicing, or operating the furnace. To ensure proper installation and operation, thoroughly read this manual for specifics pertaining to the installation and application of this product.

This furnace is manufactured for use with natural gas. It may be field converted to operate on L.P. gas by using the appropriate L.P. conversion kit listed in the **PROPANE GAS/HIGH ALTITUDE INSTALLATIONS** section of this manual

Install this furnace only in a location and position as specified in **LOCATION REQUIREMENTS & CONSIDERATIONS** section and **INSTALLATION POSITIONS** section of this manual.

Provide adequate combustion and ventilation air to the furnace as specified in **COMBUSTION & VENTILATION AIR REQUIREMENTS** section of this manual.

Combustion products must be discharged to the outdoors. Connect this furnace to an approved vent system only, as specified in **CATEGORY 1 VENTING** section of this manual.

Never test for gas leaks with an open flame. Use a commercially available soap solution made specifically for the detection of leaks to check all connections, as specified in **GAS SUPPLY AND PIPING** section of this manual.

Always install a furnace to operate within the furnace's intended temperature-rise range with a duct system which has external static pressure within the allowable range, as specified on the furnace rating plate and **OPERATIONAL CHECKS** section of these instructions.

When a furnace is installed so that supply ducts carry air circulated by the furnace to areas outside the space containing the furnace, the return air shall also be handled by duct(s) sealed to the furnace casing and terminating outside the space containing the furnace.

A gas-fired furnace for installation in a residential garage must be installed as specified in the **LOCATION REQUIREMENTS AND CONSIDERATIONS** section of this manual.

This furnace may be used as a construction site heater only if certain conditions are met. These conditions are listed in the **PRODUCT APPLICATION** section of this manual.

WARNING

TO PREVENT POSSIBLE PROPERTY DAMAGE, PERSONAL INJURY OR DEATH DUE TO ELECTRICAL SHOCK, THE FURNACE MUST BE LOCATED TO PROTECT THE ELECTRICAL COMPONENTS FROM WATER.

WARNING

TO PREVENT PERSONAL INJURY OR DEATH DUE TO IMPROPER INSTALLATION, ADJUSTMENT, ALTERATION, SERVICE OR MAINTENANCE, REFER TO THIS MANUAL. FOR ADDITIONAL ASSISTANCE OR INFORMATION, CONSULT A QUALIFIED INSTALLER, SERVICER AGENCY OR THE GAS SUPPLIER.

WARNING

IF THE INFORMATION IN THESE INSTRUCTIONS IS NOT FOLLOWED EXACTLY, A FIRE OR EXPLOSION MAY RESULT CAUSING PROPERTY DAMAGE, PERSONAL INJURY OR LOSS OF LIFE.

— DO NOT STORE OR USE GASOLINE OR OTHER FLAMMABLE VAPORS AND LIQUIDS IN THE VICINITY OF THIS OR ANY OTHER APPLIANCE.

— **WHAT TO DO IF YOU SMELL GAS:**

- DO NOT TRY TO LIGHT ANY APPLIANCE.
- DO NOT TOUCH ANY ELECTRICAL SWITCH; DO NOT USE ANY PHONE IN YOUR BUILDING.
- IMMEDIATELY CALL YOUR GAS SUPPLIER FROM A NEIGHBOR'S PHONE. FOLLOW THE GAS SUPPLIER'S INSTRUCTIONS.
- IF YOU CANNOT REACH YOUR GAS SUPPLIER, CALL THE FIRE DEPARTMENT.

— INSTALLATION AND SERVICE MUST BE PERFORMED BY A QUALIFIED INSTALLER, SERVICE AGENCY OR THE GAS SUPPLIER.

WARNING



HEATING UNIT SHOULD NOT BE UTILIZED WITHOUT REASONABLE, ROUTINE, INSPECTION, MAINTENANCE AND SUPERVISION. IF THE BUILDING IN WHICH ANY SUCH DEVICE IS LOCATED WILL BE VACANT, CARE SHOULD BE TAKEN THAT SUCH DEVICE IS ROUTINELY INSPECTED, MAINTAINED AND MONITORED. IN THE EVENT THAT THE BUILDING MAYBE EXPOSED TO FREEZING TEMPERATURES AND WILL BE VACANT, ALL WATER-BEARING PIPES SHOULD BE DRAINED, THE BUILDING SHOULD BE PROPERLY WINTERIZED, AND THE WATER SOURCE CLOSED. IN THE EVENT THAT THE BUILDING MAY BE EXPOSED TO FREEZING TEMPERATURES AND WILL BE VACANT, ANY HYDRONIC COIL UNITS SHOULD BE DRAINED AS WELL AND, IN SUCH CASE, ALTERNATIVE HEAT SOURCES SHOULD BE UTILIZED.

WARNING

FIRE OR EXPLOSION HAZARD

FAILURE TO FOLLOW THE SAFETY WARNINGS EXACTLY COULD RESULT IN SERIOUS INJURY, DEATH OR PROPERTY DAMAGE. NEVER TEST FOR GAS LEAKS WITH AN OPEN FLAME. USE COMMERCIALY AVAILABLE SOAP SOLUTION MADE SPECIFICALLY FOR THE DETECTION OF LEAKS TO CHECK ALL CONNECTIONS. A FIRE OR EXPLOSION MAY RESULT CAUSING PROPERTY DAMAGE, PERSONAL INJURY OR LOSS OF LIFE.

DANGER

CARBON MONOXIDE POISONING HAZARD

Special Warning for Installation of Furnace or Air Handling Units in Enclosed Areas such as Garages, Utility Rooms or Parking Areas



Carbon monoxide producing devices (such as an automobile, space heater, gas water heater, etc.) should not be operated in enclosed areas such as unventilated garages, utility rooms or parking areas because of the danger of carbon monoxide (CO) poisoning resulting from the exhaust emissions. If a furnace or air handler is installed in an enclosed area such as a garage, utility room or parking area and a carbon monoxide producing device is operated therein, there must be adequate, direct outside ventilation.

This ventilation is necessary to avoid the danger of CO poisoning which can occur if a carbon monoxide producing device continues to operate in the enclosed area. Carbon monoxide emissions can be (re)circulated throughout the structure if the furnace or air handler is operating in any mode.

CO can cause serious illness including permanent brain damage or death.

810259-216

DANGER
PELIGRO

RIESGO DE INTOXICACIÓN POR MONÓXIDO DE CARBONO

Advertencia especial para la instalación de calentadores ó manejadoras de aire en áreas cerradas como estacionamientos ó cuartos de servicio.

Los equipos ó aparatos que producen monóxido de carbono (tal como automóvil, calentador de gas, calentador de agua por medio de gas, etc) no deben ser operados en áreas cerradas debido al riesgo de envenenamiento por monóxido de carbono (CO) que resulta de las emisiones de gases de combustión. Si el equipo ó aparato se opera en dichas áreas, debe existir una adecuada ventilación directa al exterior. Esta ventilación es necesaria para evitar el peligro de envenenamiento por CO, que puede ocurrir si un dispositivo que produce monóxido de carbono sigue operando en el lugar cerrado.

Las emisiones de monóxido de carbono pueden circular a través del aparato cuando se opera en cualquier modo.

El monóxido de carbono puede causar enfermedades severas como daño cerebral permanente ó muerte.

810259-216

DANGER



RISQUE D'EMPOISONNEMENT AU MONOXYDE DE CARBONE

Advertencia especial para la instalación de calentadores ó manejadoras de aire en áreas cerradas como estacionamientos ó cuartos de servicio.

Avertissement special au sujet de l'installation d'appareils de chauffage ou de traitement d'air dans des endroits clos, tels les garages, les locaux d'entretien et les stationnements. Evitez de mettre en marche les appareils produisant du monoxyde de carbone (tels que les automobile, les appareils de chauffage autonome, etc.) dans des endroits non ventilés tels que les d'empoisonnement au monoxyde de carbone. Si vous devez faire fonctionner ces appareils dans un endroit clos, assurez-vous qu'il y ait une ventilation directe provenant de l'exterieur.

Cette ventilation est nécessaire pour éviter le danger d'intoxication au CO pouvant survenir si un appareil produisant du monoxyde de carbone continue de fonctionner au sein de la zone confinée.

Les émissions de monoxyde de carbone peuvent être recirculées dans les endroits clos, si l'appareil de chauffage ou de traitement d'air sont en marche.

Le monoxyde de carbone peut causer des maladies graves telles que des dommages permanents au cerveau et même la mort.

810259-216

AVERTISSEMENT

RISQUE D'INCENDIE OU D'EXPLOSION

SI LES CONSIGNES DE SÉCURITÉ NE SONT PAS SUIVIES À LA LETTRE, CELA PEUT ENTRAÎNER LA MORT, DE GRAVES BLESSURES OU DES DOMMAGES MATÉRIELS. NE JAMAIS VÉRIFIER LA PRÉSENCE DE FUITES DE GAZ AU MOYEN D'UNE FLAMME NUE. VÉRIFIER TOUS LES RACCORDS EN UTILISANT UNE SOLUTION SAVONNEUSE COMMERCIALE CONÇUE SPÉCIALEMENT POUR LA DÉTECTION DE FUITES. UN INCENDIE OU UNE EXPLOSION RISQUE DE SE PRODUIRE, CE QUI PEUT ENTRAÎNER LA MORT, DES BLESSURES OU DES DOMMAGES MATÉRIELS.

WARNING

SHOULD OVERHEATING OCCUR OR THE GAS SUPPLY FAIL TO SHUT OFF, TURN OFF THE MANUAL GAS SHUTOFF VALVE EXTERNAL TO THE FURNACE BEFORE TURNING OFF THE ELECTRICAL SUPPLY.

WARNING

POSSIBLE PROPERTY DAMAGE, PERSONAL INJURY OR DEATH DUE TO FIRE, EXPLOSION, SMOKE, SOOT, CONDENSATION, ELECTRICAL SHOCK OR CARBON MONOXIDE MAY RESULT FROM IMPROPER INSTALLATION, REPAIR OPERATION, OR MAINTENANCE OF THIS PRODUCT.

WARNING

TO PREVENT PERSONAL INJURY OR DEATH DUE TO IMPROPER INSTALLATION, ADJUSTMENT, ALTERATION, SERVICE OR MAINTENANCE, REFER TO THIS MANUAL. FOR ADDITIONAL ASSISTANCE OR INFORMATION, CONSULT A QUALIFIED INSTALLER, SERVICER AGENCY OR THE GAS SUPPLIER.

WARNING

TO PREVENT PERSONAL INJURY OR DEATH DUE TO ASPHYXIATION, THIS FURNACE MUST BE CATEGORY I VENTED. DO NOT VENT USING CATEGORY III VENTING.

PROVISIONS MUST BE MADE FOR VENTING COMBUSTION PRODUCTS OUTDOORS THROUGH A PROPER VENTING SYSTEM. THE LENGTH OF FLUE PIPE COULD BE A LIMITING FACTOR IN LOCATING THE FURNACE.

ADDITIONAL SAFETY CONSIDERATIONS

- This furnace is approved for Category I Venting only.
- Provisions must be made for venting combustion products outdoors through a proper venting system. The length of flue pipe could be a limiting factor in locating the furnace.

SHIPPING INSPECTION

All units are securely packed in shipping containers tested according to International Safe Transit Association specifications. The carton must be checked upon arrival for external damage. If damage is found, a request for inspection by carrier's agent must be made in writing immediately.

The furnace must be carefully inspected on arrival for damage and bolts or screws which may have come loose in transit. In the event of damage the consignee should:

1. Make a notation on delivery receipt of any visible damage to shipment or container.
2. Notify carrier promptly and request an inspection.
3. With concealed damage, carrier must be notified as soon as possible - preferably within five days.
4. File the claim with the following support documents within a nine month statute of limitations.
 - Original or certified copy of the Bill of Lading, or indemnity bond.
 - Original paid freight bill or indemnity in lieu thereof.
 - Original or certified copy of the invoice, showing trade and other discounts or reductions.
 - Copy of the inspection report issued by carrier's representative at the time damage is reported to carrier.

The carrier is responsible for making prompt inspection of damage and for a thorough investigation of each claim. The distributor or manufacturer will not accept claims from dealers for transportation damage.

Keep this literature in a safe place for future reference.

ELECTROSTATIC DISCHARGE (ESD) PRECAUTIONS

NOTE: Discharge your body's static electricity before touching unit. An electrostatic discharge can adversely affect electrical components.

Use the following precautions during furnace installation and servicing to protect the integrated control module from damage. By putting the furnace, the control, and the person at the same electrostatic potential, these steps will help avoid exposing the integrated control module to electrostatic discharge. This procedure is applicable to both installed and non-installed (ungrounded) furnaces.

1. Disconnect all power to the furnace. Do not touch the integrated control module or any wire connected to the control prior to discharging your body's electrostatic charge to ground.
2. Firmly touch a clean, unpainted, metal surface of the furnaces near the control. Any tools held in a person's hand during grounding will be discharged.
3. Service integrated control module or connecting wiring following the discharge process in step 2. Use caution not to recharge your body with static electricity; (i.e., do not move or shuffle your feet, do not touch ungrounded objects, etc.). If you come in contact with an ungrounded object, repeat step 2 before touching control or wires.
4. Discharge your body to ground before removing a new control from its container. Follow steps 1 through 3 if installing the control on a furnace. Return any old or new controls to their containers before touching any ungrounded object.

TO THE INSTALLER

Before installing this unit, please read this manual thoroughly to familiarize yourself with specific items which must be adhered to, including but not limited to: unit maximum external static pressure, gas pressures, BTU input rating, proper electrical connections, circulating air temperature rise, minimum or maximum CFM, and motor speed connections, and venting. These furnaces are designed for Category I venting only.



WARNING

TO PREVENT PROPERTY DAMAGE, PERSONAL INJURY OR DEATH DUE TO FIRE, DO NOT INSTALL THIS FURNACE IN A MOBILE HOME, TRAILER, OR RECREATIONAL VEHICLE.

PRODUCT APPLICATION

This furnace is primarily designed for residential home-heating applications. It is NOT designed or certified for use in mobile homes, trailers or recreational vehicles. Neither is it designed or certified for outdoor applications. The furnace **must** be installed indoors (i.e., attic space, crawl space, or garage area provided the garage area is enclosed with an operating door).

This furnace can be used in the following non-industrial commercial applications:

**Schools, Office buildings, Churches, Retail stores,
Nursing homes, Hotels/motels, Common or office areas**

In such applications, the furnace must be installed with the following stipulations:

- It must be installed per the installation instructions provided and per local and national codes.
- It must be installed indoors in a building constructed on site.
- It must be part of a ducted system and not used in a free air delivery application.
- It must not be used as a "make-up" air unit.
- All other warranty exclusions and restrictions apply.

This furnace may be used as a construction site heater **ONLY** if the following conditions are met:

- The vent system is permanently installed per these installation instructions.
- A room thermostat is used to control the furnace. Fixed jumpers that provide continuous heating CANNOT be used and can cause long term equipment damage. Bi-metal thermostats, or any thermostat affected by vibration must not be used during construction.
- Return air ducts are provided and sealed to the furnace.
- A return air temperature range between 60°F (16°C) and 80°F (27°C) is maintained.
- Air filters are installed in the system and replaced daily during construction and upon completion of construction.
- The input rate and temperature rise are set per the furnace rating plate.
- 100% outside air must be used for combustion during construction. Temporary ducting may be used to supply outside air to the furnace for combustion – do not connect this duct directly to the furnace. Size this duct according to NFPA 54/ANSI Z223.1 section for Combustion and Ventilation Air.
- The furnace heat exchanger, components, duct system, air filters and evaporator coils are thoroughly cleaned following final construction clean up by a qualified person.
- All furnace operating conditions (including ignition, input rate, temperature rise and venting) are verified by a qualified person according to these installation instructions.
- Furnace doors must be in place on the furnace while the furnace is operating in any mode.

Damage or repairs due to failure to comply with these requirements are not covered under the warranty.

NOTE: The Commonwealth of Massachusetts requires that the following additional requirements must also be met:

- Gas furnaces must be installed by a licensed plumber or gas fitter.
- A T-handle gas cock must be used.
- If the unit is to be installed in an attic, the passageway to and the service area around the unit must have flooring.



WARNING

TO PREVENT PROPERTY DAMAGE, PERSONAL INJURY OR DEATH DUE TO FIRE, DO NOT INSTALL THIS FURNACE IN A MOBILE HOME, TRAILER, OR RECREATIONAL VEHICLE.

To ensure proper furnace operation, install, operate and maintain the furnace in accordance with these installation and operation instructions, all local building codes and ordinances. In their absence, follow the latest edition of the National Fuel Gas Code (NFPA 54/ANSI Z223.1), and/or CAN/CSA B149 Installation Codes, local plumbing or waste water codes, and other applicable codes.

A copy of the National Fuel Gas Code (NFPA 54/ANSI Z223.1) can be obtained from any of the following:

American National Standards Institute

25 West 43rd Street, 4th Floor
New York, NY 10036

National Fire Protection Association

1 Batterymarch Park
Quincy, MA 02169

CSA International

8501 East Pleasant Valley
Cleveland, OH 44131

The rated heating capacity of the furnace should be greater than or equal to the total heat loss of the area to be heated. The total heat loss should be calculated by an approved method or in accordance with "ASHRAE Guide" or "Manual J-Load Calculations" published by the Air Conditioning Contractors of America.

In the USA, this furnace MUST be installed in accordance with the latest edition of the ANSI Z223.1 booklet entitled "National Fuel Gas Code" (NFPA 54), and the requirements or codes of the local utility or other authority having jurisdiction. Additional helpful publications available from the NFPA are, NFPA 90A - Installation of Air Conditioning and Ventilating System and NFPA 90B - Warm Air Heating and Air Conditioning System.

All venting shall be in accordance with the National Fuel Gas Code, ANSI Z223.1, or applicable local building and/or air conditioning codes.

NOTE: Furnaces with NOx screens meet the California NOx emission standards and California seasonal efficiency standards. ANNUAL inspections of the furnace and its vent system is strongly recommended.

LOCATION REQUIREMENTS AND CONSIDERATIONS

DM80SE models are approved for up flow and horizontal (left or right side down) installation. DC80SE models are approved for down flow and horizontal (left or right side down) installation.



WARNING

TO PREVENT POSSIBLE EQUIPMENT DAMAGE, PROPERTY DAMAGE, PERSONAL INJURY OR DEATH, THE FOLLOWING BULLET POINTS MUST BE OBSERVED WHEN INSTALLING THIS UNIT.

Follow the instructions listed below when selecting a furnace location. Refer also to the guidelines provided in *Combustion and Ventilation Air Requirements*.

- Centrally locate the furnace with respect to the proposed or existing air distribution system.
- Ensure the temperature of the return air entering the furnace is between 55°F and 100°F when the furnace is heating.
- If the furnace is installed in an application where the typical operating sound level of a furnace is deemed objectionable, an optional sound reduction kit is available. Consult your local distributor for more details.
- Provisions must be made for venting combustion products outdoors through a proper venting system. The length of flue pipe could be a limiting factor in locating the furnace.
- Ensure adequate combustion air is available for the furnace. Improper or insufficient combustion air can expose building occupants to gas combustion products that could include carbon monoxide. Refer to *Combustion and Ventilation Air Requirements*.
- The furnace must be level. If the furnace is to be set on a floor that may become wet or damp at times, the furnace should be supported above the floor on a concrete base sized approximately 1-1/2" larger than the base of the furnace.
- Ensure upflow or horizontal furnaces are not installed directly on carpeting, or any other combustible material. The only combustible material allowed is wood.
- Exposure to contaminated combustion air will result in safety and performance-related problems. Do not install the furnace where the combustion air is exposed to the following substances:
 - chlorinated waxes or cleaners
 - chlorine-based swimming pool chemicals
 - water softening chemicals
 - deicing salts or chemicals
 - carbon tetrachloride
 - halogen type refrigerants
 - cleaning solutions (such as perchloroethylene)
 - printing inks
 - paint removers
 - varnishes
 - hydrochloric acid
 - cements and glues
 - antistatic fabric softeners for clothes dryers and masonry acid washing materials
- If the furnace is used in connection with a cooling unit, install the furnace upstream or in parallel with the cooling unit coil. Premature heat exchanger failure will result if the cooling unit coil is placed ahead of the furnace.

For vertical (upflow or downflow) applications, the minimum cooling coil width shall not be less than furnace width minus 1". Additionally, a coil installed above an upflow furnace or under a counterflow furnace may be the same width as the furnace or may be one size larger than the furnace. Example: a "C" width coil may be installed with a "B" width furnace.

For upflow applications, the front of the coil and furnace must face the same direction.

- If the furnace is installed in a residential garage, position the furnace so that the burners and ignition source are located not less than 18 inches (457 mm) above the floor. Protect the furnace from physical damage by vehicles.
- If the furnace is installed horizontally, the furnace access doors must be vertical so that the burners fire horizontally into the heat exchanger. Do not install the unit with the access doors on the "up/top" or "down/bottom" side of the furnace.
- Do not connect this furnace to a chimney flue that serves a separate appliance designed to burn solid fuel.
- For counterflow installations, the air conditioning coil must be downstream from the heat exchanger of the furnace.
- Counterflow installation over a noncombustible floor. Before setting the furnace over the plenum opening, ensure the surface around the opening is smooth and level. A tight seal should be made between the furnace base and floor by using a silicon rubber caulking compound or cement grout.
- Counterflow installation over a combustible floor. If installation over a combustible floor becomes necessary, use an accessory subbase (see Specification Sheet applicable to your model for details). A special accessory subbase must be used for upright counterflow unit installations over any combustible material including wood. Follow the instructions with the subbase for proper installations. Do not install the furnace directly on carpeting, tile, or other combustible material other than wood flooring. **(NOTE:** The subbase will not be required if an air conditioning coil is installed between the supply air opening on the furnace and the floor.

Vent Pipe Clearance to Combustibles- 6" using Single Wall Connector or 1" using B-1 vent.

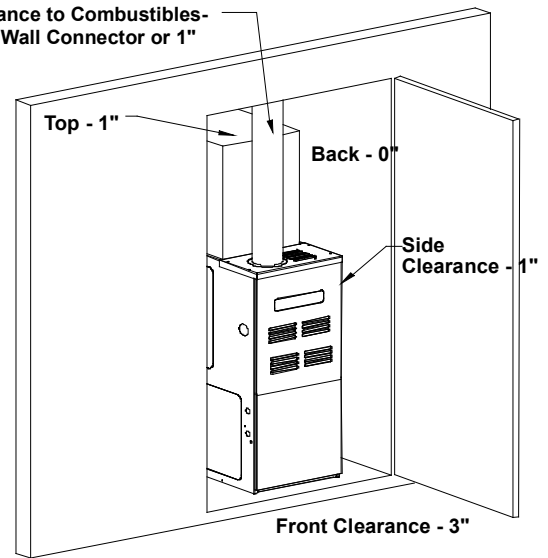

- Adequate combustion/ventilation air must be supplied to the closet.
- Furnace must be **completely** sealed to floor or base. Combustion/ ventilation air supply pipes must terminate 12" from top of closet and 12" from floor of closet. DO NOT remove solid base plate for side return.
- Return air ducts must be **completely** sealed to the furnace and terminate outside the enclosure surfaces.

CLEARANCES AND ACCESSIBILITY

Clearance in accordance with local installation codes, the requirements of the gas supplier and the manufacturer's installation instructions.

D'agagement conforme aux codes d'installation locaux, aux exigences du fournisseur de gaz et aux instructions d'installation du fabricant.

Unobstructed front clearance of 24" **for servicing** is recommended.

VENT		SIDES	FRONT	BACK	TOP (PLENUM)
B1-VENT	SINGLE				
1"	6"	1"	3"	0"	1"

Top clearance for horizontal configuration - 1"

INSTALLATION POSITIONS

An upflow furnace may be installed in an upright position or horizontal on either the left or right side panel. Do not install this furnace on its back. For vertically installed *upflow* furnaces, return air ductwork may be attached to the side panel(s) and/or basepan. For *horizontally* installed *upflow* furnaces, return air ductwork must be attached to the basepan. For *counterflow* furnaces, return ductwork must be attached to the top end of the blower compartment.

NOTE: Ductwork must never be attached to the back of the furnace.

HORIZONTAL INSTALLATION

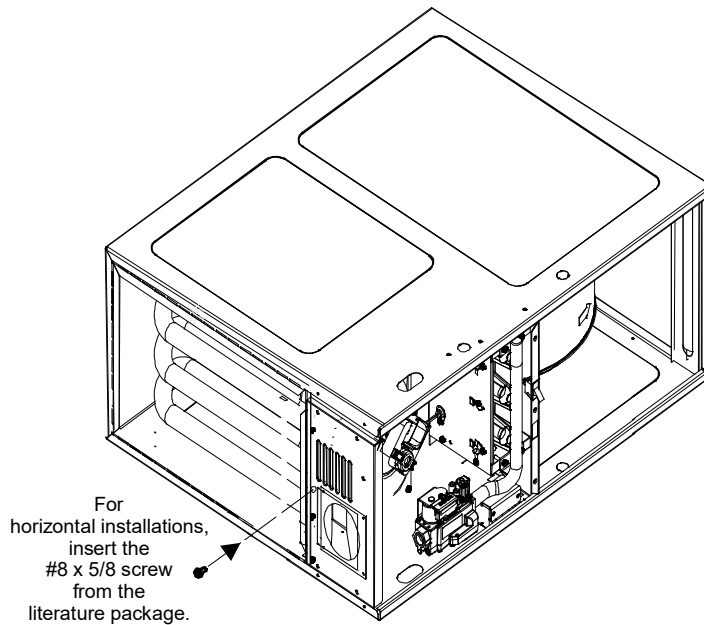

Line contact to framing is permitted when installed in the horizontal configuration. Line contact is defined as the portion of the cabinet that is formed by the intersection of the top and side. **ACCESSIBILITY CLEARANCE, WHERE GREATER, SHOULD TAKE PRECEDENCE OVER MINIMUM FIRE PROTECTION CLEARANCE.** A gas-fired furnace for installation in a residential garage must be installed so that the ignition source and burners are located not less than eighteen inches (18") above the floor and is protected or located to prevent physical damage by vehicles. A gas furnace must not be installed directly on carpeting, tile, or other combustible materials other than wood flooring.

FURNACE SUSPENSION

If suspending the furnace from rafters or joist, use 3/8" threaded rod and 2"x2"x3/8" angle iron as shown below. The length of rod will depend on the application and the clearances necessary.

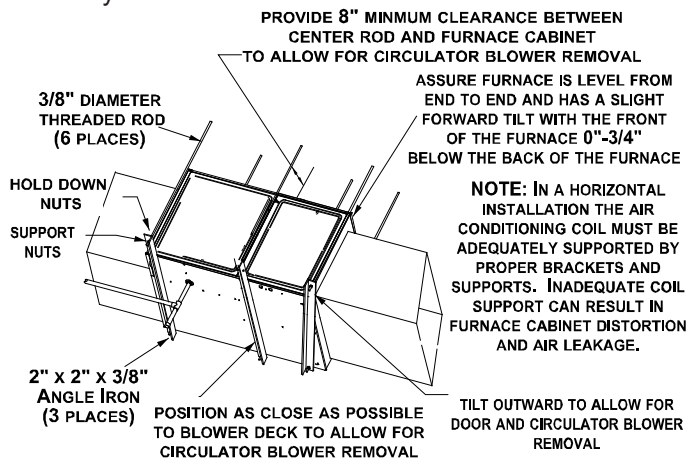

Suspended Furnace

EXISTING FURNACE REMOVAL

NOTE: When an existing furnace is removed from a venting system serving other appliances, the venting system may be too large to properly vent the remaining attached appliances.



Failure to follow the steps outlined below for each appliance connected to the venting system being placed into operation could result in carbon monoxide poisoning or death. The following steps shall be followed with each appliance connected to the venting system placed in operation, while any other appliances connected to the venting system are not in operation:

1. Seal any unused openings in the venting system.
2. Inspect the venting system for proper size and horizontal pitch, as required by the National Fuel Gas Code, ANSI z223.1 or the Natural Gas and Propane Installation Code, CSA B149.1-15 and these instructions. Determine that there is no blockage or restriction, leakage, corrosion and other deficiencies which could cause an unsafe condition.
3. As far as practical, close all building doors and windows and all doors between the space in which the appliance(s) connected to the venting system are located and other spaces of the building.
4. Close fireplace dampers.
5. Turn on clothes dryers and any appliance not connected to the venting system. Turn on any exhaust fans, such as range hoods and bathroom exhausts, so they shall operate at maximum speed. Do not operate a summer exhaust fan.
6. Follow the lighting instructions. Place the appliance being inspected in operation. Adjust thermostat so appliance shall operate continuously.
7. Test for spillage from draft hood appliances at the draft hood relief opening after 5 minutes of main burner operation. Use the flame of a match or candle.
8. If improper venting is observed during any of the above tests, the venting system must be corrected in accordance with the National Fuel Gas Code ANSI Z223.1/NFPA 54 and/or National Gas and Propane Installation Code CSA B149.1-15.
9. After it has been determined that each appliance connected to the venting system properly vents when tested as outlined above, return doors, windows, exhaust fans, fireplace dampers and any other gas burning appliance to their previous conditions of use.



AVERTISSEMENT

RISQUE D'INTOXICATION AU MONOXYDE DE CARBONE

Si les étapes décrites ci-dessous ne sont pas suivies pour chacun des appareils raccordés au système de ventilation au moment de sa mise en marche, cela peut entraîner une intoxication au monoxyde de carbone ou la mort. Les étapes suivantes doivent être suivies pour chacun des appareils raccordés au système de ventilation au moment de sa mise en marche, alors que tous les autres appareils raccordés au système de ventilation ne sont pas en marche :

1. Sceller toutes les ouvertures inutilisées du système de ventilation.
2. Inspecter le système de ventilation afin de vérifier si la taille et l'inclinaison par rapport à l'horizontale sont conformes aux exigences du National Fuel Gas Code, ANSI Z223.1/NFPA 54 ou du Code d'installation du gaz naturel et du propane, CSA B149.1 et de ces instructions. Vérifier qu'il n'y a pas d'obstruction ou de restriction, de fuite, de corrosion et d'autres problèmes qui pourraient entraîner une situation dangereuse.
3. Si possible, fermer toutes les portes et fenêtres du bâtiment ainsi que toutes les portes séparant l'endroit où se trouvent les appareils raccordés au système de ventilation et les autres zones du bâtiment.
4. Fermer le registre des foyers.
5. Mettre les sècheuses en marche ainsi que tous les autres appareils qui ne sont pas raccordés au système de ventilation. Mettre en marche tous les ventilateurs de tirage, comme celui des hottes de cuisine et des salles de bains, et les régler à la puissance maximale. Ne pas mettre en marche les ventilateurs d'étage.
6. Suivre les instructions d'allumage. Mettre en marche l'appareil soumis à l'inspection. Régler le thermostat de manière à ce que l'appareil fonctionne en continu.
7. Vérifier la présence de fuite au niveau de l'ouverture du coupe-tirage des appareils qui en sont dotés après 5 minutes de fonctionnement du brûleur principal. Utiliser la flamme d'une allumette ou d'une bougie.
8. Si un problème de ventilation est observé pendant l'un des essais décrits ci-dessus, des correctifs doivent être apportés au système de ventilation conformément au National Fuel Gas Code, ANSI Z223.1/NFPA 54 et (ou) au National Fuel Gas Code, ANSI Z223.1/NFPA 54 et (ou) au Code d'installation du gaz naturel et du propane, CSA B149.1
9. Une fois qu'il a été déterminé que chaque appareil raccordé au système de ventilation fonctionne correctement au moyen des essais décrits ci-dessus, les portes, les fenêtres, les ventilateurs, les registres de foyer et tous les autres appareils de combustion alimentés au gaz doivent être remis dans leur état initial.

THERMOSTAT LOCATION

In an area having good air circulation, locate the thermostat about five feet high on a vibration-free inside wall. Do not install the thermostat where it may be influenced by any of the following:

- Drafts, or dead spots behind doors, in corners, or under cabinets.
- Hot or cold air from registers.
- Radiant heat from the sun.
- Light fixtures or other appliances.
- Radiant heat from a fireplace.
- Concealed hot or cold water pipes, or chimneys.
- Unconditioned areas behind the thermostat, such as an outside wall.

Consult the instructions packaged with the thermostat for mounting instructions and further precautions.

COMBUSTION AND VENTILATION REQUIREMENTS



WARNING

TO AVOID PROPERTY DAMAGE, PERSONAL INJURY OR DEATH, SUFFICIENT FRESH AIR FOR PROPER COMBUSTION AND VENTILATION OF FLUE GASES MUST BE SUPPLIED. MOST HOMES REQUIRE OUTSIDE AIR BE SUPPLIED INTO THE FURNACE AREA.

Improved construction and additional insulation in buildings have reduced heat loss by reducing air infiltration and escape around doors and windows. These changes have helped in reducing heating/cooling costs but have created a problem supplying combustion and ventilation air for gas fired and other fuel burning appliances. Appliances that pull air out of the house (clothes dryers, exhaust fans, fireplaces, etc.) increase the problem by starving appliances for air.

House depressurization can cause back drafting or improper combustion of gas-fired appliances, thereby exposing building occupants to gas combustion products that could include carbon monoxide.

If this furnace is to be installed in the same space with other gas appliances, such as a water heater, ensure there is an adequate supply of combustion and ventilation air for all appliances. Refer to the latest edition of the National Fuel Gas Code NFPA 54/ANSI Z223.1 or CAN/CSA B149 Installation Codes or applicable provisions of the local building codes for determining the combustion air requirements for the appliances.

This furnace must use indoor air for combustion. It cannot be installed as a direct vent (i.e., sealed combustion) furnace.

Most homes will require outside air be supplied to the furnace area by means of ventilation grilles or ducts connecting directly to the outdoors or spaces open to the outdoors such as attics or crawl spaces.

CATEGORY I VENTING (VERTICAL VENTING)



WARNING

TO PREVENT POSSIBLE PERSONAL INJURY OR DEATH DUE TO ASPHYXIATION, THIS FURNACE MUST BE CATEGORY I VENTED. DO NOT VENT USING CATEGORY III VENTING.

Category I Venting is venting at a non-positive pressure. A furnace vented as Category I is considered a fan-assisted appliance and the vent system does not have to be “gas tight.” **NOTE:** Single stage gas furnaces with induced draft blowers draw products of combustion through a heat exchanger allowing, in some instances, common venting with natural draft appliances (i.e. water heaters). All installations must be vented in accordance with National Fuel Gas Code NFPA 54/ANSI Z223.1 - latest edition. In Canada, the furnaces must be vented in accordance with the National Standard of Canada, CAN/CSA B149.1 and CAN/CSA B149.2 - latest editions and amendments.

NOTE: Masonry vent kit (MVK-01 and MVK-02) is to only be used on interior masonry chimneys or qualifying exterior masonry chimney applications identified in the MVK kit installation instructions. To ensure safe and reliable operation, use only the kit listed for your model.

Kit	Input KBTU Range	Limit Setting
MVK-01	40-100	250°F
MVK-02	120-140	290°F

Note: This kit is for use on Daikin brand 80% AFUE, 33" tall DM80SE model furnaces installed in the upflow position only.

NOTE: The vertical height of the Category I venting system must be at least as great as the horizontal length of the venting system.



WARNING

TO PREVENT POSSIBLE PERSONAL INJURY OR DEATH DUE TO ASPHYXIATION, COMMON VENTING WITH OTHER MANUFACTURER'S INDUCED DRAFT APPLIANCES IS NOT ALLOWED.

The minimum vent diameter for the Category I venting system is as shown:

MODEL	MINIMUM VENT	
	UPFLOW	COUNTERFLOW
40	4 Inch	4 Inch
60	4 Inch	4 Inch
80	4 Inch	4 Inch
100	5 Inch	5 Inch
120	5 Inch	N/A
140	5 Inch	N/A

Under some conditions, larger vents than those shown above may be required or allowed. *When an existing furnace is removed from a venting system serving other appliances, the venting system may be too large to properly vent the remaining attached appliances.*

Upflow or Horizontal units are shipped with the induced draft blower discharging from the top of the furnace. (“Top” is as viewed for an upflow installation.) The induced draft blower can be rotated 90 degrees with the (0270F01119) chimney transition bottom kit for Category I venting. For upflow models installed vertically or horizontally, a four inch single wall pipe can be used to extend the induced draft blower outlet 1/2” beyond the furnace cabinet. **THIS PRODUCT IS NOT DESIGNED FOR COUNTERCLOCKWISE INDUCED DRAFT BLOWER ROTATION.**

Vent the furnace in accordance with the National Fuel Gas Code NFPA 54/ANSI Z223.1 - latest edition.

Venting - Furnace Installed in Horizontal Position

THIS FURNACE IS NOT DESIGN CERTIFIED TO BE HORIZONTALLY VENTED THROUGH AN EXTERIOR SIDE WALL.

The following describes an optional venting procedure when the furnace is installed in the horizontal left discharge position.

To rotate the induced draft blower clockwise, you will need to purchase one (0270F01119) chimney transition bottom kit.

1. Disconnect electrical power from the furnace.
2. Disconnect the induced draft blower power leads, flue pipe, and pressure switch tubing.
3. Remove the round cutout from the right side of the wrapper.
4. Remove and save the four screws that fasten the induced draft blower to the flue collector box.
5. Remove and save the three screws that hold the chimney assembly to the induced draft blower.
6. Remove and save the four screws that fasten the chimney top to the chimney bottom.
7. Remove the chimney transition bottom from the transition bottom kit.
8. Install the chimney top with the four screws retained from step 6 onto the new chimney transition bottom from the transition bottom kit.
9. Remove the induced draft blower and install the new chimney assembly to it using the three screws retained from step 5.
10. Rotate the induced draft blower 90 degrees to the right, feed the flue pipe through the round cutout from the outside of the wrapper, and fit onto the chimney top assembly. Secure the pipe to the chimney top from the front, top, and bottom using (3) screws and rotating the induced draft blower to properly orient the assembly. **NOTE:** If the pipe section is less than 18”, then attach it directly to the chimney top on 3 sides and feed it through the round cutout from the inside of the wrapper.
11. Reattach the induced draft blower using the (4) screws retained from step 3. Ensure the gasket located between the induced draft blower and collector box is rotated accordingly.
12. Reconnect the induced draft blower power leads.
13. Reconnect the remaining flue pipe, and the pressure switch tubing. Ensure that all wires and the pressure switch tubing is at least one inch from the flue pipe, or any other hot surface.

14. Restore power to furnace.

NOTE: In a horizontal installation the air conditioning coil must be adequately supported by proper brackets and supports. Inadequate coil support can result in furnace cabinet distortion and air leakage.

Counterflow units are shipped with the induced draft blower discharging from the top of the furnace. ("Top" as viewed for a counterflow installation.)

Vent the furnace in accordance with the National Fuel Gas Code NFPA54/ANSI Z223.1-latest edition.



WARNING

NEVER ALLOW THE PRODUCTS OF COMBUSTION, INCLUDING CARBON MONOXIDE, TO ENTER THE RETURN DUCTWORK OR CIRCULATION AIR SUPPLY.

MASONRY CHIMNEYS

An exterior masonry chimney is defined as a "Masonry" chimney exposed to the outdoors on one or more sides below the roof line."

Masonry chimneys used to vent Category I central furnaces must be either tile-lined or lined with a listed metal liner listed for venting a Category 1 appliance.. Unlined masonry chimneys are prohibited and must not be used to vent this appliance. An exterior masonry chimney that is not tile-lined must be lined with B vent or a listed insulated flexible metal vent. Insulation for the flexible vent pipe must be an encapsulated fiberglass sleeve recommended by the flexible vent pipe manufacturer. Insulation will need to be added to the flexible liner if:

- It is required by the liner manufacturer's Instructions.
- The previous liner was properly sized and installed, and suffered from condensation damage.

A listed uninsulated flexible metal vent liner may be used in an exterior tile lined chimney that is sealed and capped.

Poured insulation, vermiculite or other materials shall not be used.

For sizing of flexible liners, see the tables in the National Fuel Gas Code NFPA 54/ANSI Z223.1 - latest edition and in the National Standard of Canada, CAN/CSA B149.1 and CAN/CSA B149.2 – latest editions and amendments.

If a B vent liner is to be used, it must be supported adequately. Supports (such as fire stops or thimbles) must be used to prevent the B vent from coming into direct contact with the tile liner or chimney walls. Direct contact would result in higher heat loss, with an increased possibility of poor venting system performance.

It is not acceptable to vent one appliance inside the B vent and other appliances outside. The excess space between the B vent and the chimney walls must be covered at the top of the chimney by a weatherproof, corrosion resistant flashing.

The B vent shall then be topped with a listed vent cap.



WARNING

POSSIBILITY OF PROPERTY DAMAGE, PERSONAL INJURY OR DEATH
DAMAGING CONDENSATION CAN OCCUR INSIDE MASONRY CHIMNEYS WHEN A SINGLE FAN-ASSISTED CATEGORY I APPLIANCE (80% AFUE FURNACE) IS VENTED WITHOUT ADEQUATE DILUTION AIR. Do NOT CONNECT AN 80% FURNACE TO A MASONRY CHIMNEY UNLESS THE FURNACE IS COMMON VENTED WITH A DRAFT HOOD EQUIPPED APPLIANCE OR THE CHIMNEY IS LINED WITH A METAL LINER OR TYPE B METAL VENT. ALL INSTALLATIONS USING MASONRY CHIMNEYS MUST BE SIZED IN ACCORDANCE WITH THE APPROPRIATE VENTING TABLES. IF AN 80% FURNACE IS COMMON VENTED WITH A DRAFT HOOD EQUIPPED APPLIANCE, THE POTENTIAL FOR CONDENSATION DAMAGE MAY STILL EXIST WITH EXTREMELY COLD CONDITIONS, LONG VENT CONNECTORS, EXTERIOR CHIMNEYS, OR ANY COMBINATION OF THESE CONDITIONS. THE RISK OF CONDENSATION DAMAGE IS BEST AVOIDED BY USING MASONRY CHIMNEY AS A PATHWAY FOR PROPERLY SIZED METAL LINER OR TYPE B METAL VENT.

MASONRY CHIMNEY TERMINATION

A masonry chimney used as a vent for gas fired equipment must extend at least three feet above the highest point where it passes through the roof. It must extend at least two feet higher than any portion of a building within a horizontal distance of 10 feet. In addition, the chimney must terminate at least 3 feet above any forced air inlet located within 10 feet. The chimney must extend at least five feet above the highest connected equipment draft hood outlet or flue collar.

If the chimney does not meet these termination requirements, but all other requirements in the checklist can be met, it may be possible for a mason to extend the chimney. If this will not be practical, see Fix 1.

ELECTRICAL CONNECTIONS



WARNING

HIGH VOLTAGE !

TO AVOID THE RISK OF ELECTRICAL SHOCK, WIRING TO THE UNIT MUST BE POLARIZED AND GROUNDED.



WARNING

HIGH VOLTAGE !

TO AVOID PERSONAL INJURY OR DEATH DUE TO ELECTRICAL SHOCK, DISCONNECT ELECTRICAL POWER BEFORE SERVICING OR CHANGING ANY ELECTRICAL WIRING.



CAUTION

LABEL ALL WIRES PRIOR TO DISCONNECTION WHEN SERVICING CONTROLS. WIRING ERRORS CAN CAUSE IMPROPER AND DANGEROUS OPERATION. VERIFY PROPER OPERATION AFTER SERVICING.

 **WARNING**

HIGH VOLTAGE !

TO AVOID THE RISK OF INJURY, ELECTRICAL SHOCK OR DEATH, THE FURNACE MUST BE ELECTRICALLY GROUNDED IN ACCORDANCE WITH LOCAL CODES OR IN THEIR ABSENCE, WITH THE LATEST EDITION OF THE NATIONAL ELECTRIC CODE.



JUNCTION BOX RELOCATION

 **WARNING**

EDGES OF SHEET METAL HOLES MAY BE SHARP. USE GLOVES AS A PRECAUTION WHEN REMOVING HOLE PLUGS.

Line voltage connections can be made through either the right or left side panel. The furnace is shipped configured for a right side electrical connection. To make electrical connections through the opposite side of the furnace, the junction box must be relocated to the left side prior to making electrical connections. To relocate the junction box, perform the following steps.

 **WARNING**

TO PREVENT PERSONAL INJURY OR DEATH DUE TO ELECTRIC SHOCK, DISCONNECT ELECTRICAL POWER BEFORE INSTALLING OR SERVICING THIS UNIT.

1. Remove both doors from the furnace.
2. Remove and save the screws holding the junction box to the right side of the furnace.
3. Models that have the junction box located in the burner compartment will need to move the junction box directly over.
4. Attach the junction box to the left side of the furnace, using the screws removed in step 2.
5. Check the location of the wiring. Confirm that it will not be damaged by heat from the burners or by the rotation of the fan. Also confirm that wiring location will not interfere with filter removal or other maintenance.

After the junction box is in the desired location, use washers to connect field-supplied conduit to the junction box in accordance with NEC and local codes. Connect hot, neutral, and ground wires as shown in the furnace wiring diagram. The wires and ground screw are located in the furnace junction box.

NOTE: In downflow applications the power leads should be routed through the supplied wire tabs when rotating junction box to the left side.

Low voltage wires may be connected to the terminal strip.

IMPORTANT NOTE: To avoid possible equipment malfunction, route the low voltage wires to avoid interference with filter removal or other maintenance.

 **WARNING**

HIGH VOLTAGE !

TO AVOID THE RISK OF INJURY, ELECTRICAL SHOCK OR DEATH, THE FURNACE MUST BE ELECTRICALLY GROUNDED IN ACCORDANCE WITH LOCAL CODES OR IN THEIR ABSENCE, WITH THE LATEST EDITION OF THE NATIONAL ELECTRIC CODE.



WIRING HARNESS

The wiring harness is an integral part of this furnace. Field alteration to comply with electrical codes should not be required. Wires are color coded for identification purposes. Refer to the wiring diagram for wire routings. If any of the original wire as supplied with the furnace must be replaced, it must be replaced with wiring material having a temperature rating of at least 105° C. Any replacement wiring must be a copper conductor.

115 VOLT LINE CONNECTIONS

Before proceeding with electrical connections, ensure that the supply voltage, frequency, and phase correspond to that specified on the unit rating plate. Power supply to the furnace must be NEC Class 1, and must comply with all applicable codes. The furnace must be electrically grounded in accordance with local codes or, in their absence, with the latest edition of The National Electric Code, ANSI NFPA 70 and/or The Canadian Electric Code CSA C22.1.

Use a separate fused branch electrical circuit containing properly sized wire, and fuse or circuit breaker. The fuse or circuit breaker must be sized in accordance with the maximum overcurrent protection specified on the unit rating plate. An electrical disconnect must be provided at the furnace location.

Line voltage wiring must enter into the junction box provided with the furnace.

NOTE: Line polarity must be observed when making field connections.

FOSSIL FUEL APPLICATIONS

This furnace can be used in conjunction with a heat pump in a fossil fuel application. A fossil fuel application refers to a combined gas furnace and heat pump installation which uses an outdoor temperature sensor to determine the most cost efficient means of heating heat pump or gas furnace.

A heat pump thermostat with *two stages of heat* is required to properly use a furnace in conjunction with a heat pump. Refer to the fossil fuel kit installation instructions for additional thermostat requirements.

Strictly follow the wiring guidelines in the fossil fuel kit installation instructions. All furnace connections must be made to the furnace integrated control module and the FURNACE terminal strip on the fossil fuel control board.

To ensure proper unit grounding, the ground wire should run from the furnace ground screw located inside the furnace junction box all the way back to the electrical panel. **NOTE:** Do not use gas piping as an electrical ground. To confirm proper unit grounding, turn off the electrical power and perform the following check.

1. Measure resistance between the neutral (white) connection and one of the burners.
2. Resistance should measure 10 ohms or less.

This furnace is equipped with a blower door interlock switch which interrupts unit voltage when the blower door is opened for servicing. Do not defeat this switch.

24 VOLT THERMOSTAT WIRING

NOTE: Wire routing must not interfere with circulator blower operation, filter removal, or routine maintenance.

Low voltage connections can be made through either the right or left side panel. Thermostat wiring entrance holes are located in the blower compartment. The following figure shows connections for a “heat only” system and “heat/cool system”.

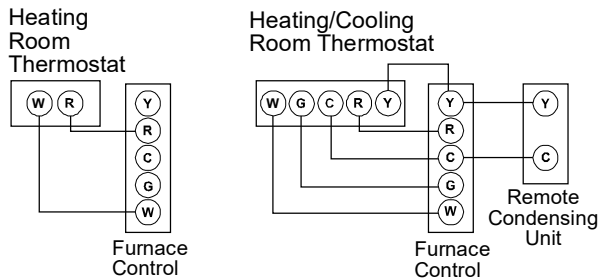

Typical Field Wiring (24 VAC Control Circuit)

This furnace is equipped with a 40 VA transformer to facilitate use with most cooling equipment. Consult the wiring diagram, located on the blower compartment door, for further details of 115 Volt and 24 Volt wiring.

A single-stage thermostat with only one heating stage can be used to control this furnace.

115 VOLT LINE CONNECTION OF ACCESSORIES (HUMIDIFIER AND ELECTRONIC AIR CLEANER)

The furnace integrated control module is equipped with line voltage accessory terminals for controlling power to an optional field-supplied humidifier and/or electronic air cleaner.

Turn OFF power to the furnace before installing any accessories. Follow the humidifier or air cleaner manufacturers’ instructions for locating, mounting, grounding, and controlling these accessories. Accessory wiring connections are to be made through the 1/4” quick connect terminals provided on the furnace integrated control module. The humidifier hot terminal is identified as 120V HUM-H, its neutral terminal is identified as 120V HUM-N. The electronic air cleaner hot terminal is identified as EAC-H, its neutral terminal is identified as 120V EAC-N. All field wiring must conform to applicable codes. Connections should be made as shown. (See Connecting Line Voltage Accessories.)

If it is necessary for the installer to supply additional line voltage wiring to the inside of the furnace, the wiring must conform to all local codes, and have a minimum temperature rating of 105°C. All line voltage wire splices must be made inside the furnace junction box.

The integrated control module humidifier terminal 120V HUM-H is energized with 115 volts whenever the induced draft blower is energized. This terminal can also be used to provide 115 volt power to a humidifier transformer. The remaining primary transformer wire would be connected to the Line N on the control board. The integrated control module electronic air cleaner terminals EAC-H is energized with 115 volts whenever the circulator blower is energized.

NOTE: Wire routing must not interfere with circulator blower operation, filter removal, or routine maintenance.

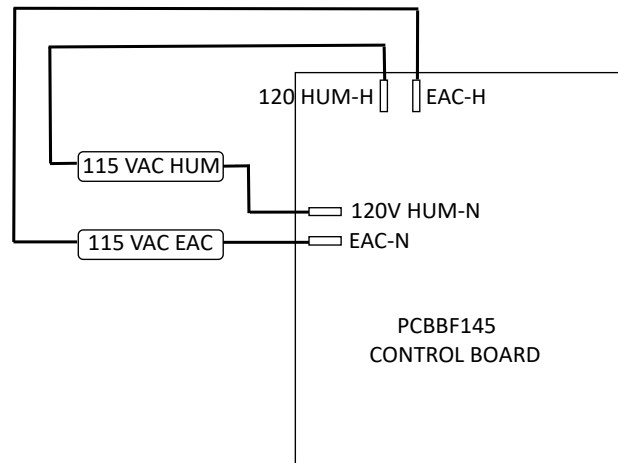

Connecting Line Voltage Accessories

CONNECTION OF 24 VOLT HUMIDIFIER

The integrated control module single humidifier terminal “24 VHUM” is energized with 24 volts whenever the induced draft blower is energized. Connect the common side of the 24 volt humidifier to the “C” terminal of the thermostat terminal strip on the control board.

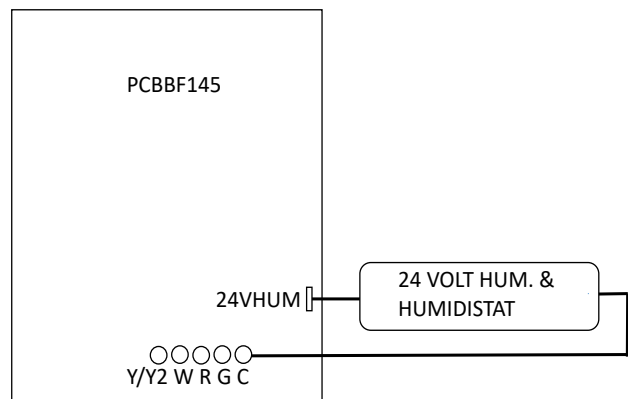

TWINNING

Furnaces may be twinned without the use of a twinning kit. Furnaces must be the same model and equipped with PCBBF145 control boards. Follow the diagram provided in this manual. Connection of the "twin" terminals of each control together will allow simultaneous operation of two or more furnace indoor blowers to operate synchronously on a common duct system. Field installed low voltage thermostat wiring, 3/16" terminals are required to make this connection. An isolating relay (24 VAC coil & N/O SPST) contacts is also required if the furnaces are not fed from the same line voltage phase. A pulsing DC signal is used to share the call for fan operation between furnaces. The duration of the pulse width determines the speed that the reading control will energize its blower motor.

CAUTION

TO PREVENT UNRELIABLE OPERATION OR EQUIPMENT DAMAGE, THE GAS MANIFOLD PRESSURE MUST BE AS SPECIFIED ON THE UNIT RATING PLATE. ONLY MINOR ADJUSTMENTS SHOULD BE MADE BY ADJUSTING THE GAS VALVE PRESSURE REGULATOR.

WARNING

POSSIBLE PROPERTY DAMAGE, PERSONAL INJURY OR DEATH MAY OCCUR IF THE CORRECT CONVERSION KITS ARE NOT INSTALLED. THE APPROPRIATE KITS MUST BE APPLIED TO ENSURE SAFE AND PROPER FURNACE OPERATION. ALL CONVERSIONS MUST BE PERFORMED BY A QUALIFIED INSTALLER OR SERVICE AGENCY.

GAS SUPPLY AND PIPING

The furnace rating plate includes the approved furnace gas input rating and gas types. The furnace must be equipped to operate on the type of gas applied. This includes any conversion kits required for alternate fuels and/or high altitude.

NOTE: Do not remove the gas valve inlet plug before the gas line is installed. Replace if water or debris has been introduced.

CAUTION

TO PREVENT UNRELIABLE OPERATION OR EQUIPMENT DAMAGE, THE INLET GAS SUPPLY PRESSURE MUST BE AS SPECIFIED ON THE UNIT RATING PLATE WITH ALL OTHER HOUSEHOLD GAS FIRED APPLIANCES OPERATING.

Inlet gas supply pressures must be maintained within the ranges specified in the following table. The supply pressure must be constant and available with all other household gas fired appliances operating. The minimum gas supply pressure must be maintained to prevent unreliable ignition. The maximum must not be exceeded to prevent unit overfiring.

INLET GAS SUPPLY PRESSURE		
Natural Gas	Minimum: 4.5" w.c.	Maximum: 10.0" w.c.
Propane Gas	Minimum: 11.0" w.c.	Maximum: 13.0" w.c.

NOTE: Adjusting the minimum supply pressure below the limits in the above table could lead to unreliable ignition. Gas

input to the burners must not exceed the rated input shown on the rating plate. Overfiring of the furnace can result in premature heat exchanger failure. Gas pressures in excess of 13 inches water column can also cause permanent damage to the gas valve.

At all altitudes, the manifold pressure must be within 0.3 inches w.c. of that listed in the Specification Sheet applicable to your model for the fuel used. At all altitudes and with either fuel, the air temperature rise must be within the range listed on the furnace nameplate. Should this appliance be converted to LP, refer to the instructions included in the factory authorized LP conversion kit.

HIGH ALTITUDE DERATE

IMPORTANT NOTE: The furnace, as shipped, requires no change to run between 0 - 5500 feet. Do not attempt to increase the firing rate by changing orifices or increasing the manifold pressure below 5500 feet. This can cause poor combustion and equipment failure.

High altitude installations above 5500 feet may require both a pressure switch and an orifice change. These changes are necessary to compensate for the natural reduction in the density of both the gas fuel and the combustion air at higher altitude.

For installations above 5500 feet, please refer to your distributor for required kit(s).

All conversions must be performed by a qualified installer, or service agency.

PROPANE GAS CONVERSION

WARNING

POSSIBLE PROPERTY DAMAGE, PERSONAL INJURY OR DEATH MAY OCCUR IF THE CORRECT CONVERSION KITS ARE NOT INSTALLED. THE APPROPRIATE KITS MUST BE APPLIED TO ENSURE SAFE AND PROPER FURNACE OPERATION. ALL CONVERSIONS MUST BE PERFORMED BY A QUALIFIED INSTALLER OR SERVICE AGENCY.

This unit is configured for natural gas but may be converted for use with L.P. gas by installing the specified L.P. conversion Kit.

If converting to LP gas, it is recommended that an LPLP0* kit also be installed. The use of this kit will prevent the furnace from firing when the LP gas supply pressure is too low to support proper combustion.

Altitude	Gas	Kit	Orifice	Manifold Pressure	Pressure Switch
0 - 5500	Natural	None	#45	3.5" w.c.	None
	Propane	LPT-03	#55	10.0" w.c.	

TWINNING CONNECTION DIAGRAM

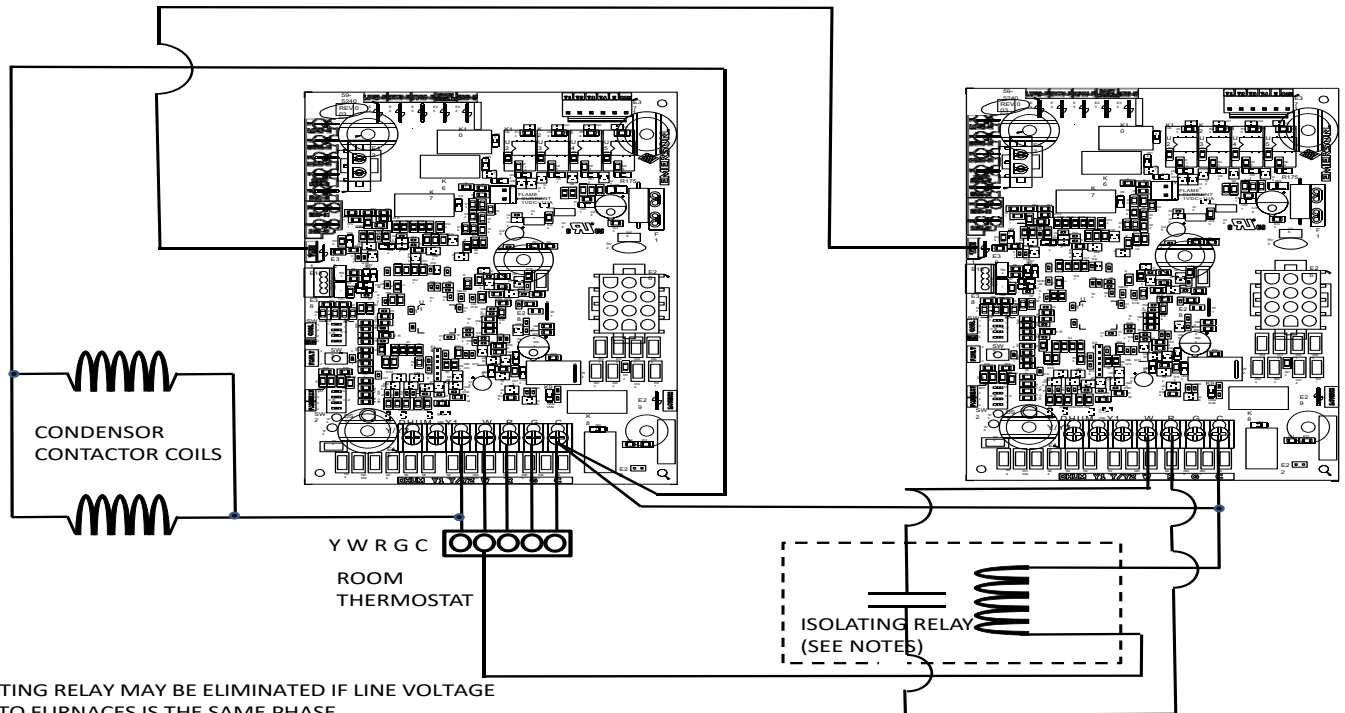

NOTES:

1. ISOLATING RELAY MAY BE ELIMINATED IF LINE VOLTAGE SUPPLY TO FURNACES IS THE SAME PHASE .
TO VERIFY PHASING:
A) VERIFY SOURCE IS EXACTLY THE SAME EITHER L1, L2, OR L3 FROM THE SAME TRANSFORMER OR
B) CHECK WITH SCOPE OR PHASE METER
C) IF IN DOUBT USE RELAY
2. IF ISOLATING RELAY IS NOT USED, CONNECT FURNACE "W" TERMINALS TOGETHER.

GAS PIPING CONNECTIONS

⚠ WARNING

TO AVOID POSSIBLE UNSATISFACTORY OPERATION OR EQUIPMENT DAMAGE DUE TO UNDERFIRING OF EQUIPMENT, USE THE PROPER SIZE OF NATURAL/PROPANE GAS PIPING NEEDED WHEN RUNNING PIPE FROM THE METER/TANK TO THE FURNACE.

When sizing gas line, be sure to include all appliances which will operate simultaneously.

The gas piping supplying the furnace must be properly sized based on the gas flow required, specific gravity of the gas, and length of the run. The gas line installation must comply with local codes, or in their absence, with the latest edition of the National Fuel Gas Code, NFPA 54/ANSI Z223.1.

**Natural Gas Capacity of Pipe
In Cubic Feet of Gas Per Hour (CFH)**

Length of Pipe in Feet	Nominal Black Pipe Size				
	1/2"	3/4"	1"	1 1/4"	1 1/2"
10	132	278	520	1050	1600
20	92	190	350	730	1100
30	73	152	285	590	980
40	63	130	245	500	760
50	56	115	215	440	670
60	50	105	195	400	610
70	46	96	180	370	560
80	43	90	170	350	530
90	40	84	160	320	490
100	38	79	150	305	460

(Pressure 0.5 psig or less and pressure drop of 0.3" W.C.; Based on 0.60 Specific Gravity Gas)

$$CFH = \frac{BTUH \text{ Furnace Input}}{\text{Heating Value of Gas (BTU/Cubic Foot)}}$$

To connect the furnace to the building's gas piping, the installer must supply a ground joint union, drip leg, manual shutoff valve, and line and fittings to connect to gas valve. In some cases, the installer may also need to supply a transition piece from 1/2" pipe to a larger pipe size.

The following stipulations apply when connecting gas piping.

- Use black iron or steel pipe and fittings for the building piping.
- Use pipe joint compound on male threads only. Pipe joint compound must be resistant to the action of the fuel used.
- Use ground joint unions.

- Install a drip leg to trap dirt and moisture before it can enter the gas valve. The drip leg must be a minimum of three inches long.
- Install a 1/8" NPT pipe plug fitting, accessible for test gage connection, immediately upstream of the gas supply connection to the furnace.
- Use two pipe wrenches when making connection to the gas valve to keep it from turning. The orientation of the gas valve on the manifold must be maintained as shipped from the factory.
- Install a manual shutoff valve between the gas meter and unit within six feet of the unit. If a union is installed, the union must be downstream of the manual shutoff valve, between the shutoff valve and the furnace.
- Tighten all joints securely.
- Connect the furnace to the building piping by one of the following methods:
 - Rigid metallic pipe and fittings.
 - Semi-rigid metallic tubing and metallic fittings. Aluminum alloy tubing must not be used in exterior locations.
 - Use listed gas appliance connectors in accordance with their instructions. Connectors must be fully in the same room as the furnace.
 - Protect connectors and semi-rigid tubing against physical and thermal damage when installed. Ensure aluminum-alloy tubing and connectors are coated to protect against external corrosion when in contact with masonry, plaster, or insulation, or subjected to repeated wetting by liquids such as water (except rain water), detergents, or sewage.

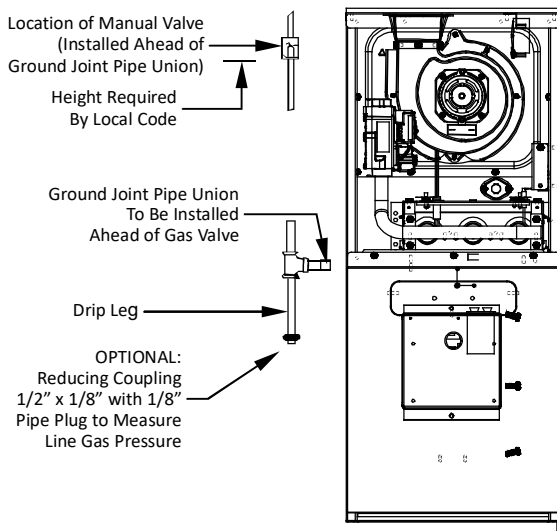

General Furnace Layout

UPFLOW INSTALLATIONS

A ground joint union, drip leg, and manual shutoff valve must also be supplied by the installer. In some cases, the installer may also need to supply a transition piece from 1/2" to another pipe size.

When the gas piping enters through the side of the furnace, the installer must supply the following fittings starting from the gas valve:

- Nipple
- Elbow
- Straight pipe to reach the exterior of the furnace.
- A ground joint union, drip leg, and manual shutoff valve must also be supplied by the installer.

COUNTERFLOW INSTALLATIONS

When the gas piping enters through the side of the furnace, the installer must supply , the following fittings starting from the gas valve:

- Nipple
- Elbow
- Straight pipe to reach the exterior of the furnace.

A ground joint union, drip leg and manual shutoff valve must also be supplied by the installer.

GAS PIPING CHECKS

Before placing unit in operation, leak test the unit and gas connections.

⚠ WARNING

TO AVOID THE POSSIBILITY OF EXPLOSION OR FIRE, NEVER USE A MATCH OR OPEN FLAME TO TEST FOR LEAKS.

Check for leaks using an approved chloride-free soap and water solution, an electronic combustible gas detector, or other approved testing methods.

⚠ CAUTION

TO PREVENT PROPERTY DAMAGE OR PERSONAL INJURY DUE TO FIRE, THE FOLLOWING INSTRUCTIONS MUST BE PERFORMED REGARDING GAS CONNECTIONS, PRESSURE TESTING, LOCATION OF SHUTOFF VALVE AND INSTALLATION OF GAS PIPING.

NOTE: Never exceed specified pressures for testing. Higher pressure may damage the gas valve and cause subsequent overfiring, resulting in heat exchanger failure.

Disconnect this unit and shutoff valve from the gas supply piping system before pressure testing the supply piping system with pressures in excess of 1/2 psig (3.48 kPa).

This unit must be isolated from the gas supply system by closing its manual shutoff valve before pressure testing of gas supply piping system with test pressures equal to or less than 1/2 psig (3.48 kPa).

PROPANE GAS TANKS AND PIPING



WARNING

IF THE GAS FURNACE IS INSTALLED IN A BASEMENT, AN EXCAVATED AREA OR CONFINED SPACE, IT IS STRONGLY RECOMMENDED TO CONTACT A PROPANE SUPPLIER TO INSTALL A GAS DETECTING WARNING DEVICE IN CASE OF A GAS LEAK.

- SINCE PROPANE GAS IS HEAVIER THAN AIR, ANY LEAKING GAS CAN SETTLE IN ANY LOW AREAS OR CONFINED SPACES.
- PROPANE GAS ODORANT MAY FADE, MAKING THE GAS UNDETECTABLE EXCEPT WITH A WARNING DEVICE.

A gas detecting warning system is the only reliable way to detect a propane gas leak. Rust can reduce the level of odorant in propane gas. Do not rely on your sense of smell. Contact a local propane gas supplier about installing a gas detecting warning system. If the presence of gas is suspected, follow the instructions in the *Safety Considerations* section of this manual.

All propane gas equipment must conform to the safety standards of the National Board of Fire Underwriters, NBFU Manual 58.

For satisfactory operation, propane gas pressure must be 10 inch WC at the furnace manifold with all gas appliances in operation. Maintaining proper gas pressure depends on three main factors:

1. Vaporization rate, depending on temperature of the liquid, and “wetted surface” area of the container or containers.
2. Proper pressure regulation. (Two-stage regulation is recommended for both cost and efficiency).
3. Pressure drop in lines between regulators, and between second stage regulator and the appliance. Pipe size will depend on length of pipe run and total load of all appliances.

Complete information regarding tank sizing for vaporization, recommended regulator settings, and pipe sizing is available from most regulator manufacturers and propane gas suppliers.

Use a pipe thread compound that is approved for natural gas and LP gas.

DUCTWORK



WARNING

NEVER ALLOW THE PRODUCTS OF COMBUSTION, INCLUDING CARBON MONOXIDE, TO ENTER THE RETURN DUCT WORK OR CIRCULATION AIR SUPPLY.

Duct systems and register sizes must be properly designed for the CFM and external static pressure rating of the furnace. Ductwork should be designed in accordance with the recommended methods of “Air Conditioning Contractors of America” Manual D.

A duct system must be installed in accordance with Standards of the National Board of Fire Underwriters for the Installation of Air Conditioning, Warm Air Heating and Ventilating Systems. Pamphlets No. 90A and 90B.

A closed return duct system must be used, with the return duct connected to the furnace. **NOTE:** Ductwork must never be attached to the back of the furnace. For installations requiring more than 1800 CFM, use a bottom return or two sided return. Supply and return connections to the furnace may be made with flexible joints to reduce noise transmission. To prevent the blower from interfering with combustion air or draft when a central return is used, a connecting duct must be installed between the unit and the utility room wall. Furnace is shipped with the top flanges in the flat position. Before installing a coil or ducts, the flanges must be bent 90°. A room, closet, or alcove must not be used as a return air chamber.

When the furnace is used in connection with a cooling unit, the furnace should be installed in parallel with or on the upstream side of the cooling unit to avoid condensation in the heating element. With a parallel flow arrangement, the dampers or other means used to control the flow of air must be adequate to prevent chilled air from entering the furnace and, if manually operated, must be equipped with means to prevent operation of either unit unless the damper is in the full heat or cool position.

When the furnace is installed without a cooling coil, it is recommended that a removable access panel be provided in the outlet air duct. This opening shall be accessible when the furnace is installed and shall be of such a size that the heat exchanger can be viewed for visual light inspection or such that a sampling probe can be inserted into the airstream. The access panel must be made to prevent air leaks when the furnace is in operation.

NOTE: In a horizontal installation the air conditioning coil must be adequately supported by proper brackets and supports. Inadequate coil support can result in furnace cabinet distortion and air leakage.

When the furnace is heating, the temperature of the return air entering the furnace must be between 55°F and 100°F.

When a furnace is installed so that supply ducts carry air circulated by the furnace to areas outside the space containing the furnace, the return air shall also be handled by a duct sealed to the furnace casing and terminating outside the space containing the furnace.

FILTERS-READ THIS SECTION BEFORE INSTALLING THE RETURN AIR DUCTWORK

Filters must be used with this furnace. Filters do not ship with this furnace, but must be provided by the installer. Filters must comply with UL900 or CAN/ULCS111 standards. Damage or repairs due to failure to install filters in the furnace are not covered under the warranty.

Depending on the installation and/or customer preference, differing filter arrangements can be applied. Filters can be

installed in the central return register or a side panel external filter rack kit (upflows), or the ductwork above a downflow furnace. As an alternative, a media air filter or electronic air cleaner can be used as the primary filter.

One of the most common causes of a problem in a forced air heating system is a blocked or dirty filter. Air filters must be inspected monthly for dirt accumulation and replaced if necessary. Failure to maintain clean filters can cause premature heat exchanger failure.

A new home may require more frequent replacement until all construction dust and dirt is removed. Air filters are to be installed in the return air duct external to the furnace cabinet.

Upflow / Horizontal Models	Minimum Recommended Filter Size [^]
0403A	1 - 16 X 25 Side or 1 - 14 X 24 Bottom Return
0603A	1 - 16 X 25 Side or 1 - 14 X 24 Bottom Return
0604B	1 - 16 X 25 Side or Bottom Return
0803B	1 - 16 X 25 Side or Bottom Return
0804B	1 - 16 X 25 Side or Bottom Return
0805C	1 - 16 X 25 Side or Bottom Return ¹
0805D	2 - 16 X 25 Side or 1 - 20 X 25 Bottom Return
1005C	2 - 16 X 25 Side or 1 - 20 X 25 Bottom Return
1205D	2 - 16 X 25 Side or 1 - 24 X 24 Bottom Return
1405D	2 - 16 X 25 Side or 1 - 24 X 24 Bottom Return

Downflow Models	Minimum Recommended Filter Size [^]
0403A	2 - 10 X 20 or 1 - 14 X 25 Top Return
0603A	2 - 10 X 20 or 1 - 14 X 25 Top Return
0804B	2 - 14 X 20 or 1 - 16 X 25 Top Return
1005C	2 - 14 X 20 or 1 - 20 X 25 Top Return

[^] Larger Filters may be used, filters may also be centrally located

¹ = use 2 - 16 X 25 filters and two side returns or 20 X 25 filter on bottom return if furnace is connected to a cooling unit over 4 tons nominal capacity

SEQUENCE OF OPERATION (INTERGRATED IGNITION CONTROL)

Refer to Timing Charts for sequencing.

POWER UP

- 115 VAC power applied to furnace.
- Integrated ignition control performs internal checks.
- Integrated ignition LED will light.
- Integrated ignition control monitors safety circuits continuously.
- Furnace awaits call from thermostat.

HEATING MODE

The normal operational sequence in heating mode is as follows:

- R and W thermostat contacts close, initiating a call for heat.
- Integrated control module performs safety circuit checks.

- Induced draft blower is energized for 15 second pre-purge period causing pressure switch contacts to close.
- Igniter warm up begins after 15 second prepurge expires.
- Gas valves open at end of igniter warm up period, delivering gas to burners and establishing flame.
- Integrated control module monitors flame presence. Gas valve will remain open only if flame is detected.
- Circulator blower is energized on heating speed following a fixed thirty second blower on delay. Electronic air cleaner terminals are energized with circulator blower.
- Furnace operates; integrated control module monitors safety circuits continuously.
- R and W thermostat contacts open, completing the call for heat.
- Gas valve closes, extinguishing flame.
- Induced draft blower is de-energized following a fifteen second post purge.
- The circulator blower remains on heating speed for the selected heat off delay period.
- Furnace awaits the next call from thermostat.

COOLING MODE

The normal operational sequence in cooling mode is as follows:

- R and Y thermostat contacts close, initiating a call for cool.
- Integrated control module performs safety circuit checks.
- Outdoor fan and compressor are energized.
- Circulator blower is energized on cool speed following a fixed five second on delay. Electronic air cleaner terminals are energized with circulator blower.
- Furnace circulator blower and outdoor cooling unit run, integrated control module monitors safety circuits continuously.
- R and Y thermostat contacts open, completing the call for cool.
- Outdoor fan and compressor are de-energized.
- Circulator blower is de-energized following a fixed forty five second cool off delay period. Electronic air cleaner terminals are de-energized.
- Furnace awaits the next call from thermostat.

FAN ONLY MODE

The normal operational sequence in fan only mode is as follows:

- R and G thermostat contacts close, initiating a call for fan.
- Integrated control module performs safety circuit checks.

- Circulator blower is energized on T1 speed. Electronic air cleaner terminals are energized.
- Circulator blower runs, integrated control module monitors safety circuits continuously.
- R and G thermostat contacts open, completing the call for fan.
- Circulator blower is de-energized. Electronic air cleaner terminals are de-energized.
- Furnace awaits the next call from thermostat.

START-UP PROCEDURE AND ADJUSTMENT

Furnace must have a 115 VAC power supply properly connected and grounded. Proper polarity must be maintained for correct operation. An interlock switch prevents furnace operation if the blower door is not in place. Keep the blower access door in place except for inspection and maintenance.

This furnace is also equipped with a self-diagnosing electronic control module. In the event a furnace component is not operating properly, the control module LED will flash on and off in a factory-programmed sequence, depending on the problem encountered. This light can be viewed through the observation window in the blower access door. Refer to the *Troubleshooting Chart* for further explanation of the fault codes

FURNACE OPERATION

Purge gas lines of air prior to start-up. Do not purge lines into an enclosed burner compartment.

Check for leaks using an approved chloride-free soap and water solution, an electronic combustible gas detector, or other approved method. Verify that all required kits (propane gas, high altitude, etc.) have been appropriately installed.

NOTE: An interlock switch prevents furnace operation if the blower door is not in place. Keep the blower access doors in place except for inspection and maintenance.

FURNACE START-UP

1. Close the manual gas shutoff valve external to the furnace.
2. Turn off the electrical power to the furnace.
3. Set the room thermostat to the lowest possible setting.
4. Remove the burner compartment door.

NOTE: This furnace is equipped with an ignition device which automatically lights the burner. Do not try to light the burner by hand.

5. *White-Rodgers valves* Push the switch to the OFF position.
6. Wait five minutes then smell for gas. Be sure to check near the floor, as some types of gas are heavier than air.
7. If gas can be smelled following the five minute waiting period in Step 6, immediately follow the instructions on Page 3 of this manual. If you do not smell gas after five minutes:

White-Rodgers valves : Push the switch to the ON position.

8. Replace the door on the front of the furnace.
9. Open the manual gas valve external to the furnace.
10. Turn on the electrical power supply to the furnace.
11. Set the room thermostat to the desired temperature.

NOTE: There is an approximate 30 second delay between thermostat energizing and burner firing.

FURNACE SHUTDOWN

1. Set the thermostat to lowest setting.
2. Turn off the electrical power supply to the furnace.
3. Remove the burner compartment door.
4. *White-Rodgers valve* : Push switch to the OFF position.
5. Close manual gas shutoff valve external to the furnace.
6. Replace the door on the unit.

GAS SUPPLY PRESSURE MEASUREMENT

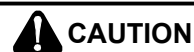

CAUTION

TO PREVENT UNRELIABLE OPERATION OR EQUIPMENT DAMAGE, THE INLET GAS SUPPLY PRESSURE MUST BE AS SPECIFIED ON THE UNIT RATING PLATE WITH ALL OTHER HOUSEHOLD GAS FIRED APPLIANCES OPERATING.



WARNING

HIGH VOLTAGE !

DISCONNECT ALL POWER BEFORE SERVICING OR INSTALLING THIS UNIT. MULTIPLE POWER SOURCES MAY BE PRESENT. FAILURE TO DO SO MAY CAUSE PROPERTY DAMAGE, PERSONAL INJURY OR DEATH.



The line pressure supplied to the gas valve must be within the range specified below. The supply pressure can be measured at the gas valve inlet pressure tap or at a hose fitting installed in the gas piping drip leg. The supply pressure must be measured with the unit OFF. To measure inlet pressure, use the following procedure.

NOTE: If measuring gas pressure at the drip leg or Honeywell gas valve, a field-supplied hose barb fitting must be installed prior to making the hose connection. If using the inlet pressure tap on the White-Rodgers gas valve, then use the 36G/J Valve Pressure Check Kit, Part No. 0151K00000S.

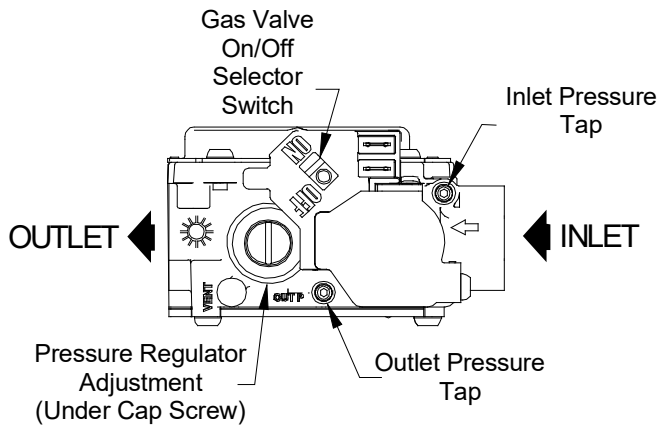

White-Rodgers Model 36J22

INLET GAS SUPPLY PRESSURE		
Natural Gas	Minimum: 4.5" w.c.	Maximum: 10.0" w.c.
Propane Gas	Minimum: 11.0" w.c.	Maximum: 13.0" w.c.

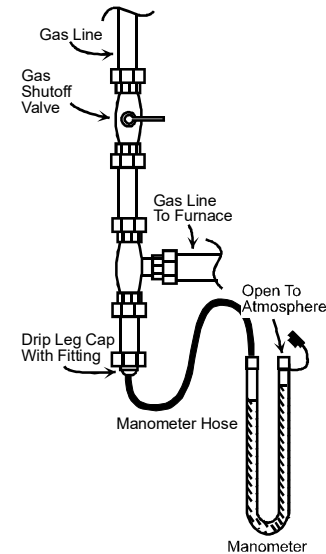

Measuring Inlet Gas Pressure (Alt. Method)

GAS MANIFOLD PRESSURE MEASUREMENT AND ADJUSTMENT

CAUTION

TO PREVENT UNRELIABLE OPERATION OR EQUIPMENT DAMAGE, THE GAS MANIFOLD PRESSURE MUST BE AS SPECIFIED ON THE UNIT RATING PLATE. ONLY MINOR ADJUSTMENTS SHOULD BE MADE BY ADJUSTING THE GAS VALVE PRESSURE REGULATOR.

WARNING

HIGH VOLTAGE !

DISCONNECT ALL POWER BEFORE SERVICING OR INSTALLING THIS UNIT. MULTIPLE POWER SOURCES MAY BE PRESENT. FAILURE TO DO SO MAY CAUSE PROPERTY DAMAGE, PERSONAL INJURY OR DEATH.



- Turn OFF gas to furnace at the manual gas shutoff valve external to the furnace.
- Turn OFF all electrical power to the system.
- Inlet pressure tap connections:
White-Rodgers valve:
Back inlet pressure test screw (inlet pressure tap) out one turn (counterclockwise, not more than one turn).
- Attach a hose and manometer to the inlet pressure tap (White-Rodgers valve).
- Turn ON the gas supply.
- Turn On power and close thermostat "R" and "W" contacts to provide a call for heat.
- Using a leak detection solution or soap suds to check for leaks at outlet pressure tap plug Bubbles forming indicate a leak. SHUT OFF GAS AND REPAIR ALL LEAKS IMMEDIATELY!
- Measure the gas supply pressure with burners firing. Adjust supply pressure using the *Inlet Gas Supply Pressure* table shown below. If supply pressure reading differs from the table, make necessary adjustments to pressure regulator, gas piping size, etc., and/or consult with local gas utility.

INLET GAS SUPPLY PRESSURE		
Natural Gas	Minimum: 4.5" w.c.	Maximum: 10.0" w.c.
Propane Gas	Minimum: 11.0" w.c.	Maximum: 13.0" w.c.

- Turn OFF all electrical power and gas supply to the system.
- Remove the manometer hose from the hose barb fitting or inlet pressure tap.
- Replace inlet pressure tap:
White-Rodgers valve:
Turn inlet pressure test screw in to seal pressure port (clockwise, 7 in-lb minimum).
- Retest for leaks. If bubbles form, shut down gas and repair leaks immediately.
- Turn ON electrical power and gas supply to the system.
- Turn valve switch ON.

This valve is shipped from the factory with the regulator preset (see control label).

Consult the appliance rating plate to ensure burner manifold pressure is as specified. If another outlet pressure is required, follow these steps.

- Turn OFF gas to furnace at the manual gas shutoff valve external to the furnace.
- Turn OFF all electrical power to the system.
- Outlet pressure tap connections:
White-Rodgers valve:
Back outlet pressure test screw (outlet pressure tap) out one turn (counterclockwise, not more than one turn).
- Attach a hose and manometer to the outlet pressure tap.
- Turn ON the gas supply.

6. Turn ON power and close thermostat “R” and “W” contacts to provide a call for heat.
7. Using a leak detection solution or soap suds to check for leaks at outlet pressure tap. Bubbles forming indicate a leak. SHUT OFF GAS AND REPAIR ALL LEAKS IMMEDIATELY!
8. Measure the gas manifold pressure with burners firing. Adjust manifold pressure using the *Manifold Gas Pressure* table shown below.

Manifold Gas Pressure	
Natural Gas	3.2" - 3.8" w.c.
Propane Gas	9.7" - 10.3" w.c.

9. Remove regulator cover screw from the outlet pressure regulator and turn screw clockwise to increase pressure or counterclockwise to decrease pressure. Replace regulator cover screw.
10. Turn OFF all electrical power and gas supply to the system.
11. Remove the manometer hose from the hose barb fitting or outlet pressure tap .
12. Replace outlet pressure tap:
 - White-Rodgers valve: Turn outlet pressure test screw in to seal pressure port (clockwise, 7 in-lb minimum).
13. Turn ON electrical power and gas supply to the system.
14. Close thermostat contacts to provide a call for heat.
15. Retest for leaks. If bubbles form, SHUT OFF GAS AND REPAIR ALL LEAKS IMMEDIATELY!

GAS INPUT RATE MEASUREMENT (NATURAL GAS ONLY)

The gas input rate to the furnace must never be greater than that specified on the unit rating plate. To measure natural gas input using the gas meter, use the following procedure.

1. Turn OFF the gas supply to all other gas-burning appliances except the furnace.
2. While the furnace is operating, time and record one complete revolution of the smallest gas meter dial.
3. Calculate the number of seconds per cubic foot (sec/ft³) of gas being delivered to the furnace. If the dial is a two cubic foot dial, divide the number of seconds recorded in step 2 by two.
4. Calculate the furnace input in BTUs per hour (BTU/hr). Input equals the installation’s gas heating value multiplied by a conversion factor (hours to seconds), divided by the number of seconds per cubic foot. The measured input must not be greater than the input indicated on the unit rating plate.

EXAMPLE:

Installation’s gas heating (HTG) value: 1,000 BTU/ft³
(Obtained from gas supplier)

Installation’s seconds per cubic foot: 34 sec/ft³

Conversion Factor (hours to seconds): 3600 sec/hr

Input = (Htg. value x 3600) ÷ seconds per cubic foot

Input = (1,000 BTU/ft³ x 3600 sec/hr) ÷ 34 sec/ft³

Input = 106,000 BTU/hr

This measured input must not be greater than the input indicated on the unit rating plate.

5. Turn ON gas and relight appliances turned off in step 1. Ensure all the appliances are functioning properly and that all pilot burners are operating.

TEMPERATURE RISE

Air temperature rise is the temperature difference between supply and return air. The proper amount of temperature rise is usually obtained when the unit is operated at the rated input with the “as shipped” blower speed. If the correct amount of temperature rise is not obtained, it may be necessary to change the blower speed.

An incorrect temperature rise can cause condensing in or overheating of the heat exchanger. Determine and adjust the temperature rise as follows. The temperature rise must be within the range specified on the rating plate or Specification Sheet applicable to your model. *(Please contact your distributor or our website for the applicable Specification Sheet referred to in this manual.)*

CROSS-HATCHED AREA SUBJECTED TO RADIANT HEAT. DO NOT MEASURE SUPPLY AIR TEMPERATURE IN THIS AREA.

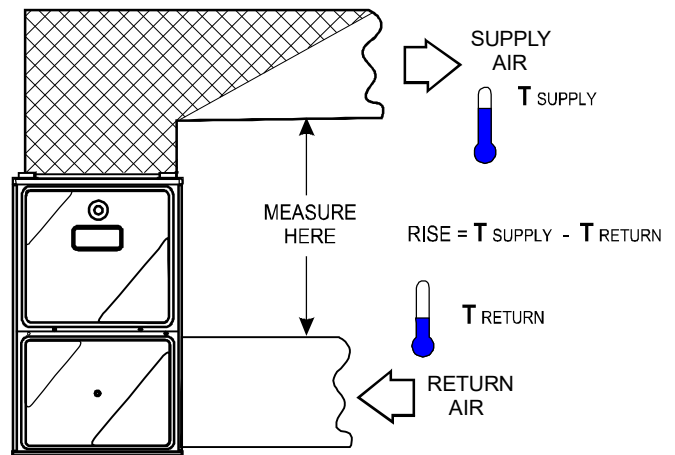

Temperature Rise Measurement

1. Operate furnace with burners firing approximately 15 minutes. Ensure all registers are open and all duct dampers are in their final (fully or partially open) position.
2. Place thermometers in the return and supply ducts as close to the furnace as possible. Thermometers must not be influenced by radiant heat by being able to “see” the heat exchanger.
3. Subtract the return air temperature from the supply air temperature to determine the air temperature rise. Allow adequate time for thermometer readings to stabilize.
4. Adjust temperature rise by adjusting the circulator blower speed. Increase blower speed to reduce temperature rise. Decrease blower speed to increase temperature rise. Refer to the following section for speed changing details.

CIRCULATOR BLOWER SPEED ADJUSTMENT



WARNING

TO AVOID PERSONAL INJURY OR DEATH DUE TO ELECTRICAL SHOCK, TURN OFF POWER TO THE FURNACE BEFORE CHANGING SPEED TAPS.

Furnaces are equipped with a EEM circulator blower motor. This provides ease in adjusting blower speeds. Refer to the Blower Performance Data in the back of the manual for proper selection of heating and cooling speeds.

To adjust the circulator blower speed, proceed as follows:

1. Motor speed Tap wiring must remain in factory position on the control board and motor
2. There are 4 speed Tap wires to the motor T1, T2, T3, T4.)
3. There are 5 speeds available, depending on DIP switch settings mentioned in air flow tables for each size furnace.
4. Cooling speed can be adjusted by adjusting S1-1, S1-2, S1-3 (see cooling airflow Chart for reference).
5. Heating speed can be adjusted by adjusting S2-1, S2-2 (see Heating airflow Chart).
6. Circulation / Continuous Fan speed can be adjusted by adjusting S2-3, S2-4 (see Circulation airflow Chart).
7. Verify Proper temperature rise as outlined in the Temperature Rise section of Startup Procedure and Adjustment. Please refer to the tables below for dip switch settings.

Motor Tap Identification		
CONNECTOR ID	DESCRIPTION	CONNECTOR VOLTAGE
L	LINE, L1	LINE, L1
G	GROUND	CHASSIS GROUND
N	LINE, L2	LINE, L2
C	SIGNAL COMMON	24VAC COMMON
1	TAP 1	24VAC
2	TAP 2	24VAC
3	TAP 3	24VAC
4	TAP 4	24VAC
5	TAP 5	24VAC

Heat Off Delay (S1-4)				
S1-4	Min	Nom	Max	Units
ON		*150		Seconds
OFF		100		Seconds
* = DEFAULT SETTING				

COOL MOTOR SPEED DIP SWITCH SETTING (S1-1, S1-2, S1-3)			
		1 2 3	1 2 3
	Position	OFF OFF OFF	ON OFF OFF
Motor Speed COOL	Y	T1	T2
		1 2 3	*1 2 3
		ON ON OFF	OFF OFF ON
Motor Speed COOL	T3	T4	T1+T2
		1 2 3	1 2 3
		OFF ON ON	ON ON ON
Motor Speed COOL	T1	T1	T1
* = DEFAULT SETTING			

HEAT MOTOR SPEED DIP SWITCH SETTING (S2-1, S2-2)					
		1 2	*1 2	1 2	1 2
	Position	OFF OFF	ON OFF	ON ON	OFF ON
Motor Speed HEAT	W	T1	T2	T3	T4
* = DEFAULT SETTING					

FAN MOTOR SPEED DIP SWITCH SETTING (S2-3, S2-4)					
		*3 4	3 4	3 4	3 4
	Position	OFF OFF	ON OFF	OFF ON	ON ON
Motor Speed FAN	G	T1	T2	T4	T1+T2
* = DEFAULT SETTING					

OPERATIONAL CHECKS



WARNING

TO AVOID PERSONAL INJURY OR DEATH, DO NOT REMOVE ANY INTERNAL COMPARTMENT COVERS OR ATTEMPT ANY ADJUSTMENT. ELECTRICAL COMPONENTS ARE CONTAINED IN BOTH COMPARTMENTS. CONTACT A QUALIFIED SERVICE AGENT AT ONCE IF AN ABNORMAL FLAME APPEARANCE SHOULD DEVELOP.

CHECKING DUCT STATIC

Refer to your furnace rating plate for the maximum ESP (external duct static) rating.

Total external static refers to everything external to the furnace cabinet. Cooling coils, filters, ducts, grilles, registers must all be considered when reading your total external static pressure. The supply duct pressure must be read between the furnace and the cooling coil. This reading is usually taken by removing the "A" shaped block off plate from the end on the coil; drilling a test hole in it and reinstalling the block off plate. Take a duct static reading at the test hole. Tape up the test hole after your test is complete. The negative pressure must be read between the filter and the furnace blower.

Excessive external static pressure will result in insufficient air that can cause excessive temperature rise. This can cause limit switch tripping and heat exchanger failure.

To determine total external duct static pressure, proceed as follows;

1. With clean filters in the furnace, use a draft gauge (inclined manometer) to measure the static pressure of the return duct at the inlet of the furnace. (Negative Pressure)
2. Measure the static pressure of the supply duct. (Positive Pressure)
3. The difference between the two numbers is .4" w.c.

Example:

static reading from return duct = -.1" w.c.

static reading from supply duct = .3" w.c.

total external static pressure on this system = .4" w.c.

NOTE: Both readings may be taken simultaneously and read directly on the manometer if so desired. If an air conditioner coil or Electronic Air Cleaner is used in conjunction with the furnace, the readings must also include these components, as shown in the following drawing.

4. Consult proper tables for the quantity of air.

If the total external static pressure exceeds the maximum listed on the furnace rating plate, check for closed dampers, registers, undersized and/or oversized poorly laid out duct work.

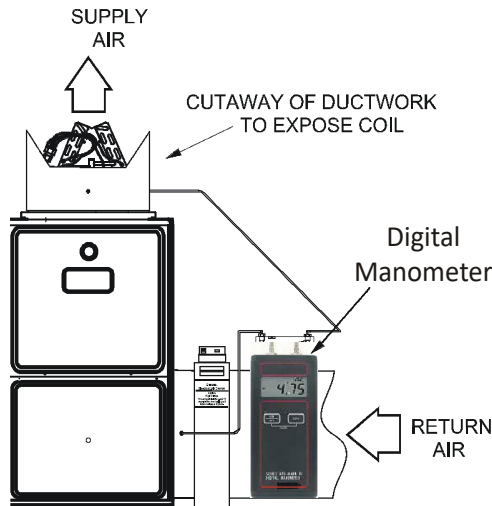

Checking Static Pressure

BURNER FLAME

The burner flames should be inspected with the burner compartment door installed. Flames should be stable, quiet, soft, and blue (dust may cause orange tips but they must not be yellow). Flames should extend directly outward from the burners without curling, floating, or lifting off. Flames must not impinge on the sides of the heat exchanger firing tubes.

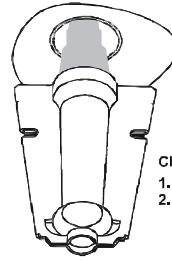

Check the burner flames for:
 1. Stable, soft and blue
 2. Not curling, floating, or lifting off.

Burner Flame

WARNING

TO AVOID PERSONAL INJURY OR DEATH, DO NOT REMOVE ANY INTERNAL COMPARTMENT COVERS OR ATTEMPT ANY ADJUSTMENT. ELECTRICAL COMPONENTS ARE CONTAINED IN BOTH COMPARTMENTS. CONTACT A QUALIFIED SERVICE AGENT AT ONCE IF AN ABNORMAL FLAME APPEARANCE SHOULD DEVELOP.

SAFETY CIRCUIT DESCRIPTION

GENERAL

A number of safety circuits are employed to ensure safe and proper furnace operation. These circuits serve to control any potential safety hazards and serve as inputs in the monitoring and diagnosis of abnormal function. These circuits are continuously monitored during furnace operation by the integrated control module.

INTEGRATED CONTROL MODULE

The integrated control module is an electronic device which controls all furnace operations. Responding to the thermostat, the module initiates and controls normal furnace operation, and monitors and addresses all safety circuits. If a potential safety concern is detected, the module will take the necessary precautions and provide diagnostic information through an LED

ERROR CODE	
Red LED Flash	Error / Condition
Flash Codes stored in memory (auto-erased after 14 days)	
1	System Lockout (Retries Exceeded)
2	Pressure Switch stuck Closed
3	Pressure Switch stuck Open
4	Open Main or Auxillary Temperature Limit Switch
5	Flame Sensed>4.25 Seconds with Gas Valve De-Energized
6	Open Rollout Temperature Limit Switch
8	Igniter Relay Fault
10	Open Fuse
11	Igniter Open
12	Inducer Relay Error
Flash Codes NOT stored in memory	
7	Low Flame Sense Signal
9	Twinning Fault
OFF	Control Failure / No Power / Internal Fault / IRQ Loss. Gas Heating Lockout (Gas valve energized when it should be de-energized) Or Gas Valve De-energized when it should be Energized
Rapid Flash	Reverse Polarity
Continuous On	Normal Operation

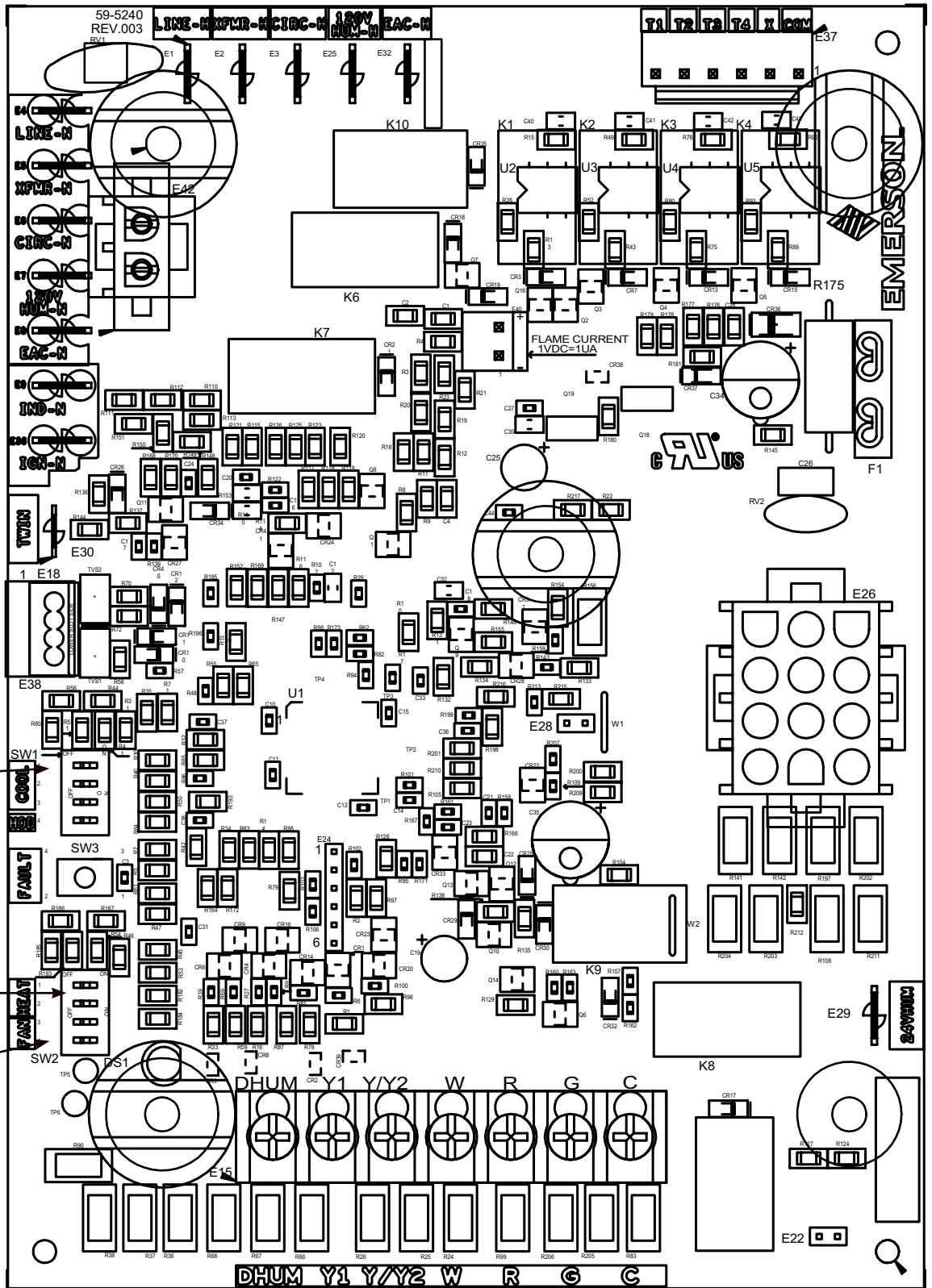

Cooling Dip Switches

Heat Dip Switches

Fan Dip Switches

PRIMARY LIMIT

The primary limit control is located on the partition panel and monitors heat exchanger compartment temperatures. It is an automatic reset, temperature sensor. The limit guards against the overheating resulting from insufficient air passing over the heat exchanger.

AUXILIARY LIMIT

The auxiliary limit control is located either on or near the circulator blower and monitors heat exchanger compartment temperatures. The control is an automatic reset, temperature sensor. It guards against overheating resulting from insufficient air passing over the heat exchanger. The auxiliary limit control is suitable for both horizontal right and horizontal left installations. Regardless of airflow direction, it does not need to be relocated.

ROLLOUT LIMITS

The rollout limit controls are mounted on the burner/manifold assembly and monitor the burner flame. They are manual-reset, temperature sensors. This limit guards against burner flames not being properly drawn into the heat exchanger.

PRESSURE SWITCHES

The pressure switches are normally-open, negative air pressure-activated switches. They monitor the airflow (combustion air and flue products) through the heat exchanger via pressure taps located on the induced draft blower. These switches guard against insufficient airflow (combustion air and flue products) through the heat exchanger.

FLAME SENSOR

The flame sensor is a probe mounted to the burner/manifold assembly which uses the principle of flame rectification to determine the presence or absence of flame.

TROUBLESHOOTING

DIAGNOSTIC CHART

Refer to the troubleshooting chart in the Appendix for assistance in determining the source of unit operational problems. The red diagnostic LED blinks to assist in troubleshooting the unit. The number of blinks refer to a specific code.

RESETTING FROM LOCKOUT

Furnace lockout results when a furnace is unable to achieve ignition after three attempts. It is characterized by a non-functioning furnace and a one flash diagnostic LED code from the red LED. If the furnace is in "lockout", it will (or can be) reset in any of the following ways.

1. Automatic reset. The integrated control module will automatically reset itself and attempt to resume normal operations following a one hour lockout period.
2. Manual power interruption. Interrupt 115 volt power to the furnace for 1 - 20 seconds.
3. Manual thermostat cycle. Lower the thermostat so that there is no longer a call for heat for 1 - 20 seconds then reset to previous setting.

NOTE: If the condition which originally caused the lockout still exists, the control will return to lockout. Refer to the Diagnostic Chart for aid in determining the cause.

MAINTENANCE

WARNING

TO AVOID ELECTRICAL SHOCK, INJURY OR DEATH, DISCONNECT ELECTRICAL POWER BEFORE PERFORMING ANY MAINTENANCE. IF YOU MUST HANDLE THE IGNITER, HANDLE WITH CARE. TOUCHING THE IGNITER ELEMENT WITH BARE FINGERS, ROUGH HANDLING, OR VIBRATION COULD DAMAGE THE IGNITER RESULTING IN PREMATURE FAILURE. ONLY A QUALIFIED SERVICER SHOULD EVER HANDLE THE IGNITER.

ANNUAL INSPECTION

The furnace should be inspected by a qualified installer, or service agency at least once per year. This check should be performed at the beginning of the heating season. This will ensure that all furnace components are in proper working order and that the heating system functions appropriately. Pay particular attention to the following items. Repair or service as necessary.

- Flue pipe system. Check for blockage and/or leakage. Check the outside termination and the connections at and internal to the furnace.
- Heat exchanger. Check for corrosion and/or buildup within the heat exchanger passageways.
- Burners. Check for proper ignition, burner flame, and flame sense.
- Wiring. Check that electrical connections are tight and free from corrosion.
- Filters.

FILTERS

WARNING

TO AVOID PROPERTY DAMAGE, PERSONAL INJURY OR DEATH, DISCONNECT ELECTRICAL POWER BEFORE REMOVING FILTERS. NEVER OPERATE FURNACE WITHOUT A FILTER INSTALLED BECAUSE DUST AND LINT WILL BUILD UP ON INTERNAL PARTS RESULTING IN LOSS OF EFFICIENCY, EQUIPMENT DAMAGE AND POSSIBLE FIRE.

A return air filter is not supplied with this furnace; however, there must be a means of filtering all of the return air. The installer will supply filter(s) at the time of installation.

FILTER MAINTENANCE

Improper filter maintenance is the most common cause of inadequate heating or cooling performance. Filters should be cleaned (permanent) or replaced (disposable) every two months or as required.



WARNING

HIGH VOLTAGE!

TO PREVENT PROPERTY DAMAGE, PERSONAL INJURY OR DEATH DUE TO ELECTRICAL SHOCK, DISCONNECT ELECTRICAL POWER TO THE FURNACE BEFORE REMOVING THE FILTER OR PERFORMING ANY OTHER MAINTENANCE.



BURNERS



WARNING

TO PREVENT PERSONAL INJURY OR DEATH, DO NOT REMOVE ANY INTERNAL COMPARTMENT COVERS OR ATTEMPT ANY ADJUSTMENT. ELECTRICAL COMPONENTS ARE CONTAINED IN BOTH COMPARTMENTS. CONTACT A QUALIFIED SERVICE AGENT AT ONCE IF AN ABNORMAL FLAME APPEARANCE SHOULD DEVELOP.

FILTER REMOVAL

Depending on the installation, differing filter arrangements can be applied. Filters can be installed in either the central return register or a side panel external filter rack (upflow only). A media air filter or electronic air cleaner can be used as an alternate filter. Follow the filter sizes given in the Recommended Minimum Filter size table or instruction provided by the media or electronic air cleaner manufacturer to ensure proper unit performance.

To remove filters from an external filter rack in an upright up-flow installation, follow the directions provided with external filter rack kit.

INDUCED DRAFT AND CIRCULATOR BLOWER MOTORS

The bearings in the induced draft blower and circulator blower motors are permanently lubricated by the manufacturer. No further lubrication is required. Check motor windings for accumulation of dust which may cause overheating. Clean as necessary.

FLAME SENSOR (QUALIFIED SERVICER ONLY)

Under some conditions, the fuel or air supply can create a nearly invisible coating on the flame sensor. This coating acts as an insulator causing a drop in the flame sense signal. If the flame sense signal drops too low the furnace will not sense flame and will lock out. The flame sensor should be carefully cleaned by a qualified servicer using steel wool. The flame sense signal should be 1 to 3 microamps.

IGNITER (QUALIFIED SERVICER ONLY)

At room temperature, the igniter ohm reading should be from 37 - 68 ohms.

Periodically during the heating season, make a visual check of the burner flames. Turn the furnace on at the thermostat. Wait a few minutes, since any dislodged dust will alter the normal flame appearance. Flames should be stable, quiet, soft and blue with slightly orange tips. They should not be yellow. They should extend directly outward from the burner ports without curling downward, floating or lifting off the ports.

CLEANING (QUALIFIED SERVICER ONLY)

1. Shut off electric power and gas supply to the furnace.
2. Disconnect the rollout limit wires, flame sensor wire, and disconnect the igniter plug.



CAUTION

LABEL ALL WIRES PRIOR TO DISCONNECTION WHEN SERVICING CONTROLS. WIRING ERRORS CAN CAUSE IMPROPER AND DANGEROUS OPERATION. VERIFY PROPER OPERATION AFTER SERVICING.

3. Remove four (4) screws securing the burner box top.



CAUTION

THE IGNITER IS FRAGILE AND CAN BE EASILY DAMAGED. USE EXTREME CAUTION WHEN REMOVING THE BURNER BOX TOP.

4. Remove the screws securing the burners to the burner bracket. Remove the burners.
5. Use bottle brush to clean burner insert and inside of burner.
6. Replace burner (opposite of removal). Ensure burners are fully seated on burner bracket and are properly aligned. Replace burner box top. Reconnect wiring.
7. Turn on electric power and gas supply to the furnace.
8. Check furnace for proper operation. Refer to "Operational Checks" section to verify burner flame characteristics.

BEFORE LEAVING AN INSTALLATION

- Cycle the furnace with the thermostat at least three times. Verify cooling and fan only operation.
- Review the Owner's Manual with the homeowner and discuss proper furnace operation and maintenance.
- Leave literature packet near furnace.

REPAIR AND REPLACEMENT PARTS

- When ordering any of the listed functional parts, be sure to provide the furnace model, manufacturing, and serial numbers with the order.
- Although only functional parts are shown in the parts list, all sheet metal parts, doors, etc. may be ordered by description.
- Parts are available from your distributor.



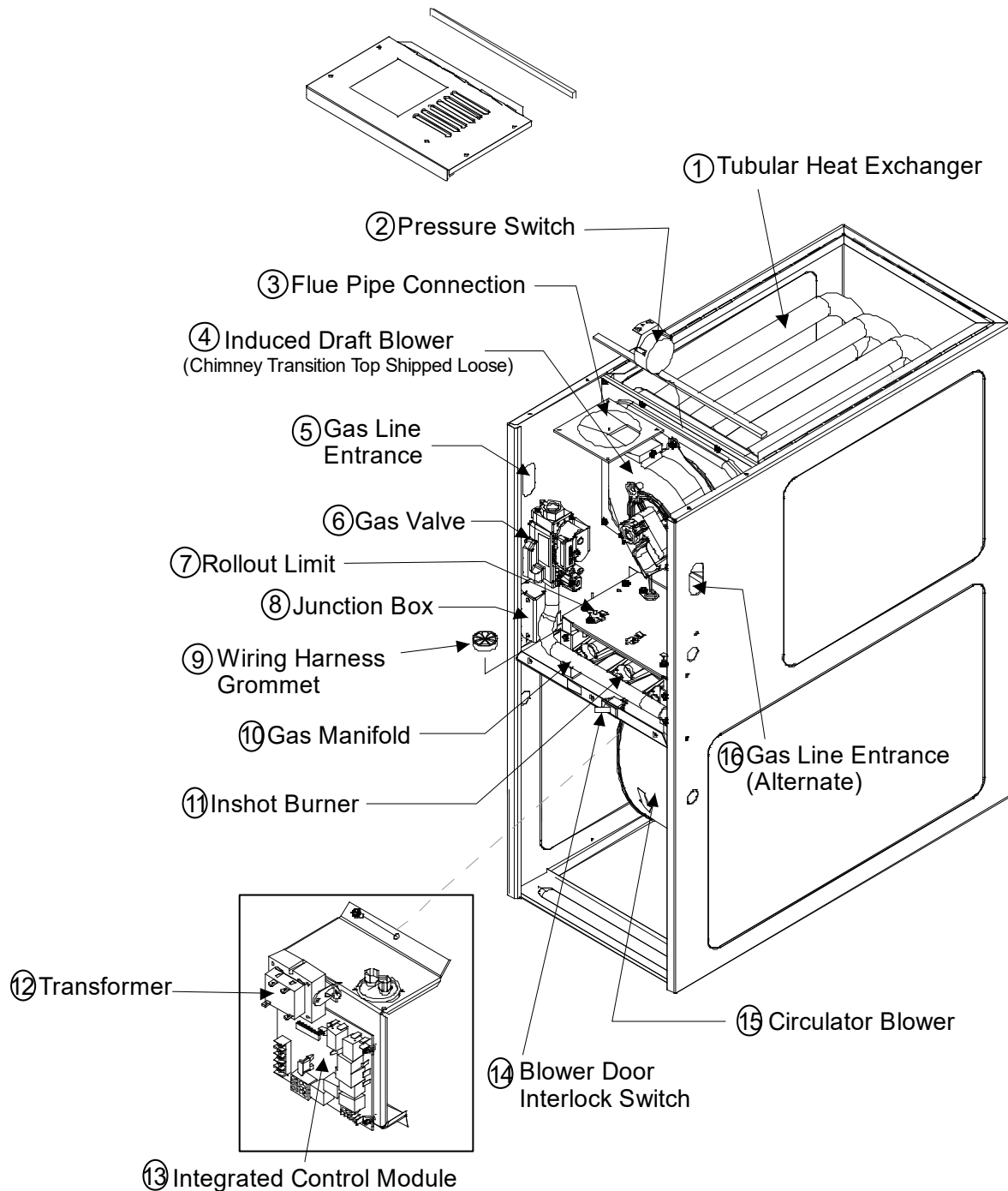

Functional Parts List-

Gas Valve	Blower/Collector Box Gasket
Natural Gas Orifice	Primary Limit Switch
Propane Gas Orifice	Rollout Limit Switch
Burner	Auxiliary Limit Switch
Hot Surface Igniter	Heat Exchanger
Flame Sensor	Door Switch
Gas Manifold	Transformer
Ignition Control	Blower Wheel
Blower Mounting Bracket	Blower Housing
Pressure Switch	Blower Cutoff
Pressure Switch Hose	Blower Motor
Induced Draft Blower	Motor Mount Bracket
Collector Box	Capacitor

COMPONENT ID







- | | |
|--------------------------|----------------------------------|
| 1 Tubular Heat Exchanger | 9 Wiring Harness Grommet |
| 2 Pressure Switch | 10 Gas Manifold |
| 3 Flue Pipe Connection | 11 Inshot Burner |
| 4 Induced Draft Blower | 12 Transformer |
| 5 Gas Line Entrance | 13 Integrated Control Module |
| 6 Gas Valve | 14 Blower Door Interlock Switch |
| 7 Rollout Limit | 15 Circulator Blower |
| 8 Junction Box | 16 Gas Line Entrance (Alternate) |

Symptoms of Abnormal Operation	Associated LED Code ²	Fault Description(s)	Possible Causes	Corrective Action	Cautions and Notes
<ul style="list-style-type: none"> Furnace fails to operate. Integrated control module diagnostic LED provides no signal. 	OFF	<ul style="list-style-type: none"> No 115 volt power to furnace, or no 24 volt power to integrated control module. Blown fuse or circuit breaker. Integrated control module has an internal fault. 	<ul style="list-style-type: none"> Manual disconnect switch OFF, door switch open, or 24 volt wires improperly connected or loose. Blown fuse or circuit breaker. Integrated control module has an internal fault. 	<ul style="list-style-type: none"> Assure 115 and 24 volt power to furnace integrated control module. Check integrated control module fuse (3A). Replace if necessary. Check for possible shorts in 115 and 24 volt circuits. Repair as necessary. Replace bad integrated control module. 	<ul style="list-style-type: none"> Turn power OFF prior to repair. Replace integrated control module fuse with 3A automotive fuse. Read precautions in "Electrostatic Discharge" section of manual.
<ul style="list-style-type: none"> LED is Steady On. 		<ul style="list-style-type: none"> Normal Operation 	<ul style="list-style-type: none"> Normal Operation 	<ul style="list-style-type: none"> None 	<ul style="list-style-type: none"> Normal Operation
<ul style="list-style-type: none"> Furnace fails to operate. Integrated control module diagnostic LED is flashing ONE (1) flash. 		<ul style="list-style-type: none"> Furnace lockout due to an excessive number of ignition "retries" (3 total)¹. 	<ul style="list-style-type: none"> Failure to establish flame. Cause may be no gas to burners, front cover pressure switch stuck open, bad igniter or igniter alignment, improper orifices, coated/oxidized or improperly connected flame sensor. Loss of flame after establishment. Cause may be interrupted gas supply, lazy burner flames (improper gas pressure or restriction in flue and/or combustion air piping), front cover pressure switch opening, improper induced draft blower performance. 	<ul style="list-style-type: none"> Locate and correct gas interruption. Check front cover pressure switch operation (hose, wiring, contact operation). Correct if necessary. Replace or realign igniter. Check flame sense signal. Sand sensor if coated and/or oxidized. Check flue piping for blockage, proper length, elbows, and termination. Verify proper induced draft blower performance. 	<ul style="list-style-type: none"> Turn power OFF prior to repair. Igniter is fragile, handle with care. Sand flame sensor with emery cloth. See "Vent/ Flue Pipe" section for piping details.
<ul style="list-style-type: none"> Furnace fails to operate. Integrated control module diagnostic LED is flashing TWO (2) flashes. 		<ul style="list-style-type: none"> Pressure switch circuit is closed. Induced draft blower is not operating. 	<ul style="list-style-type: none"> Induced draft blower pressure switch contacts sticking. Shorts in pressure switch circuit. 	<ul style="list-style-type: none"> Replace induced draft blower pressure switch. Repair short. 	<ul style="list-style-type: none"> Turn power OFF prior to repair. Replace pressure switch with proper replacement part.
<ul style="list-style-type: none"> Induced draft blower runs continuously with no further furnace operation. Integrated control module diagnostic LED is flashing THREE (3) flashes. 		<ul style="list-style-type: none"> Pressure switch circuit not closed. Induced draft blower is operating. 	<ul style="list-style-type: none"> Pressure switch hose blocked, pinched or connected improperly. Blocked flue and/or inlet air pipe, blocked drain system, or weak induced draft blower. Incorrect pressure switch setpoint or malfunctioning switch contacts. Loose or improperly connected wiring. 	<ul style="list-style-type: none"> Inspect pressure switch hose. Repair, if necessary. Inspect flue and/or inlet air piping for blockage, proper length, elbows, and termination. Check drain system. Correct as necessary. Correct pressure switch setpoint or contact motion. Tighten or correct wiring connection. 	<ul style="list-style-type: none"> Turn power OFF prior to repair. Replace pressure switch with proper replacement part.





¹Integrated control module will automatically attempt to reset from lockout after one hour.

²LED Flash code will cease if power to the control module is interrupted through the disconnect or door switch.

Symptoms of Abnormal Operation	Associated LED Code ²	Fault Description(s)	Possible Causes	Corrective Action	Cautions and Notes
<ul style="list-style-type: none"> Circulator blower runs continuously. No furnace operation. Integrated control module diagnostic LED is flashing FOUR (4) flashes. 	 4 FLASHES	<ul style="list-style-type: none"> Primary or auxiliary limit circuit is open. 	<ul style="list-style-type: none"> Faulty primary or auxiliary limit switch. Insufficient conditioned air over the heat exchanger. Blocked filters, restrictive ductwork, improper circulator blower speed, or failed circulator blower. Loose or improperly connected wiring. 	<ul style="list-style-type: none"> Check primary/auxiliary limit. Replace if necessary. Check filters and ductwork for blockage. Clean filters or remove obstruction. Check circulator blower speed and performance. Correct speed or replace blower if necessary. Tighten or correct wiring connection. 	<ul style="list-style-type: none"> Turn power OFF prior to repair. Replace primary/auxiliary limit with proper replacement part. Replace blower with correct replacement part.
<ul style="list-style-type: none"> Induced draft blower and circulation blower runs continuously. No furnace operation. Integrated control module diagnostic LED is flashing FIVE (5) flashes. 	 5 FLASHES	<ul style="list-style-type: none"> Flame sensed with no call for heat. 	<ul style="list-style-type: none"> Short to ground in flame sense circuit. 	<ul style="list-style-type: none"> Correct short at flame sensor or in flame sensor wiring. 	<ul style="list-style-type: none"> Turn power OFF prior to repair.
<ul style="list-style-type: none"> Furnace fails to operate. Integrated control module diagnostic LED is flashing SIX (6) flashes. No furnace operation. 	 6 FLASHES	<ul style="list-style-type: none"> Rollout limit open. Integrated control module fuse is blown. 	<ul style="list-style-type: none"> Flame rollout. Misaligned burners, blocked flue and/or air inlet pipe, or failed induced draft blower. Loose or improperly connected wiring. Short in 24 volt AC control circuits or safety circuits. Faulty rollout limit. 	<ul style="list-style-type: none"> Check burners for proper alignment. Check flue and air inlet piping for blockage, proper length, elbows, and termination. Correct as necessary. Check rollout limit. Replace if necessary. Check induced draft blower for proper performance. Replace, if necessary. Tighten or correct wiring connection. 	<ul style="list-style-type: none"> Turn power OFF prior to repair. See "Vent/Flue Pipe" section for piping details. Replace induced draft blower with correct replacement part. Replace integrated control module fuse with 3A automotive fuse. Read precautions in "Electrostatic Discharge" section of manual. Replace rollout limit with correct replacement part.
<ul style="list-style-type: none"> Normal furnace operation. Integrated control module diagnostic LED is flashing SEVEN (7) flashes. 	 7 FLASHES	<ul style="list-style-type: none"> Flame sense microamp signal is low. 	<ul style="list-style-type: none"> Flame sensor is coated/oxidized. Flame sensor incorrectly positioned in burner flame. Lazy burner flame due to improper gas pressure or combustion air. 	<ul style="list-style-type: none"> Sand flame sensor. Inspect for proper sensor alignment. Compare current gas pressure to rating plate info. Adjust as needed. 	<ul style="list-style-type: none"> Turn power OFF prior to repair. Clean flame sensor with steel wool. See "Vent/Flue Pipe" section for piping details. See rating plate for proper gas pressure.
<ul style="list-style-type: none"> Furnace not operating. Integrated control module diagnostic LED is flashing EIGHT (8) flashes. 	 8 FLASHES	<ul style="list-style-type: none"> Igniter Relay Fault 	<ul style="list-style-type: none"> Improperly connected igniter. Bad igniter. Poor unit ground. Poor burner ground. Faulty integrated control module. 	<ul style="list-style-type: none"> Check and correct wiring from integrated control module to igniter. Replace bad igniter. Check & correct unit ground wire. Replace bad integrated control module. 	<ul style="list-style-type: none"> Turn power OFF prior to repair. Replace igniter w/proper replacement part. Read precautions in "Electrostatic Discharge" section of manual.

¹Integrated control module will automatically attempt to reset from lockout after one hour.

²LED Flash code will cease if power to the control module is interrupted through the disconnect or door switch.

Symptoms of Abnormal Operation	Associated LED Code ²	Fault Description(s)	Possible Causes	Corrective Action	Cautions and Notes
<ul style="list-style-type: none"> • Circulating blowers not operating simultaneously. No blower operation. 	 9 FLASHES	<ul style="list-style-type: none"> • Twinning Fault 	<ul style="list-style-type: none"> • Furnace twin terminals not connected together by field wiring. • Isolating relay not used or improperly installed 	<ul style="list-style-type: none"> • Install field wiring connecting twin terminals, check continuity of wiring. • Verify each furnace fan motor is operable without twinning connection. • Wire per twinning diagram in this installation manual 	<ul style="list-style-type: none"> • Verify line voltage supply is turned off before proceeding with corrections
<ul style="list-style-type: none"> • Furnace not operating. • Integrated control module diagnostic LED is flashing TEN (10) flashes. 	 10 FLASHES	<ul style="list-style-type: none"> • Open Fuse / No 24V power to integrated control module 	<ul style="list-style-type: none"> • High voltage surge blows off the fuse. 	<ul style="list-style-type: none"> • Replace the Fuse. 	<ul style="list-style-type: none"> • Verify line voltage supply is turned off before proceeding with corrections
<ul style="list-style-type: none"> • Furnace not operating. • Integrated control module diagnostic LED is flashing ELEVEN (11) flashes. 	 11 FLASHES	<ul style="list-style-type: none"> • Igniter Open 	<ul style="list-style-type: none"> • Improperly connected igniter. • Bad igniter. • Poor unit ground. • Poor burner ground. 	<ul style="list-style-type: none"> • Check and correct wiring from integrated control module to igniter. • Replace bad igniter. • Check & correct unit ground wire. • Replace bad integrated control module. 	<ul style="list-style-type: none"> • Turn power OFF prior to repair. • Replace igniter w/proper replacement part. • Read precautions in "Electrostatic Discharge" section of manual.
<ul style="list-style-type: none"> • Furnace not operating. • Integrated control module diagnostic LED is flashing TWELVE (12) flashes. 	 12 FLASHES	<ul style="list-style-type: none"> • Inducer Relay Fault 	<ul style="list-style-type: none"> • Improperly connected inducer. • Bad inducer. • Poor unit ground. • Faulty integrated control module. 	<ul style="list-style-type: none"> • Check and correct wiring from integrated control module to inducer. • Check for Blockage in inducer & in Vent / replace Inducer. • Check & correct unit ground wire. • Replace bad integrated control module. 	<ul style="list-style-type: none"> • Turn power OFF prior to repair. • Replace inducer w/proper replacement part. • Read precautions in "Electrostatic Discharge" section of manual.
<ul style="list-style-type: none"> • Furnace fails to operate. • Integrated control module diagnostic LED is flashing continuously. 	 CONTINUOUS RAPID FLASH	<ul style="list-style-type: none"> • Polarity of 115 or 24 volt power is reversed. 	<ul style="list-style-type: none"> • Polarity of 115 volt AC power to furnace or integrated control module is reversed. • Orange and gray wires to transformer are reversed. • Poor unit ground. 	<ul style="list-style-type: none"> • Review wiring diagram to correct polarity. • Reverse orange and gray wires going to transformer. • Verify proper ground. Correct if necessary. 	<ul style="list-style-type: none"> • Turn power OFF prior to repair

¹Integrated control module will automatically attempt to reset from lockout after one hour.

²LED Flash code will cease if power to the control module is interrupted through the disconnect or door switch.

BLOWER PERFORMANCE DATA

*CES80

Heating Airflow

MODEL		DIP SWITCHES S2-1 , S2-2		EXTERNAL STATIC PRESSURE, (INCHES WATER COLUMN)												
				0.1		0.2		0.3		0.4		0.5		0.6	0.7	0.8
				CFM	RISE	CFM	RISE	CFM	RISE	CFM	RISE	CFM	RISE	CFM	CFM	CFM
CES	800403A	OFF OFF	668	44	650	46	600	49	555	53	507	N/A	459	411	352	
		ON OFF*	785	38	754	39	736	40	690	43	650	46	604	565	527	
		ON ON	862	34	827	36	823	36	787	38	770	38	733	692	655	
		OFF ON**	1104	N/A	1058	N/A	1020	N/A	1022	N/A	1013	N/A	981	952	918	
CES	800603A	OFF OFF	716	N/A	647	N/A	592	N/A	541	N/A	478	N/A	420	368	296	
		ON OFF*	1054	42	1002	44	951	47	906	49	861	52	820	797	754	
		ON ON	960	46	900	49	854	52	802	55	782	57	735	695	639	
		OFF ON**	1160	N/A	1102	N/A	1055	N/A	1017	N/A	970	N/A	930	891	847	
CES	800804B	OFF OFF	784	N/A	716	N/A	645	N/A	583	N/A	516	N/A	405	334	282	
		ON OFF*	1295	46	1252	47	1203	49	1153	51	1114	53	1071	1022	981	
		ON ON	1401	N/A	1366	N/A	1320	N/A	1278	N/A	1236	N/A	1213	1194	1153	
		OFF ON**	1596	N/A	1553	N/A	1512	N/A	1491	N/A	1450	N/A	1411	1388	1347	
CES	800805C	OFF OFF	1171	N/A	884	N/A	667	N/A	576	N/A	495	N/A	399	338	302	
		ON OFF*	1175	50	1098	54	1024	58	947	63	883	N/A	823	764	703	
		ON ON	1436	41	1402	42	1362	44	1313	45	1244	48	1182	1132	1079	
		OFF ON**	1782	N/A	1744	N/A	1715	N/A	1700	N/A	1660	N/A	1619	1579	1510	
CES	801005C	OFF OFF	803	N/A	719	N/A	631	N/A	540	N/A	471	N/A	337	298	265	
		ON OFF**	1424	52	1385	53	1332	56	1284	58	1229	60	1176	1130	1078	
		ON ON	1626	N/A	1574	N/A	1524	N/A	1479	N/A	1433	N/A	1410	1400	1358	
		OFF ON**	1820	N/A	1769	N/A	1726	N/A	1685	N/A	1642	N/A	1603	1557	1521	

* Default & Recommended

** NOT RECOMMENDED

Circulation Airflow

MODEL		DIP SWITCHES S2-3 , S2-4		EXTERNAL STATIC PRESSURE, (INCHES WATER COLUMN)									
				0.1	0.2	0.3	0.4	0.5	0.6	0.7	0.8	0.9	1
				CFM	CFM	CFM	CFM	CFM	CFM	CFM	CFM	CFM	CFM
CES	800403A	OFF OFF	668	650	600	555	507	459	411	352	291	259	
		ON OFF	785	754	736	690	650	604	565	527	482	438	
		OFF ON	1104	1058	1020	1022	1013	981	952	918	887	855	
		ON ON	1348	1294	1261	1250	1229	1233	1205	1182	1156	1129	
CES	800603A	OFF OFF	716	647	592	541	478	420	368	296	245	198	
		ON OFF	1054	1002	951	906	861	820	797	754	704	660	
		OFF ON	1160	1102	1055	1017	970	930	891	847	800	780	
		ON ON	1411	1356	1313	1272	1235	1198	1162	1127	1094	1063	
CES	800804B	OFF OFF	784	716	645	583	516	405	334	282	229	197	
		ON OFF	1295	1252	1203	1153	1114	1071	1022	981	931	883	
		OFF ON	1596	1553	1512	1491	1450	1411	1388	1347	1312	1272	
		ON ON	1757	1713	1691	1664	1625	1588	1552	1522	1488	1447	
CES	800805C	OFF OFF	1171	884	667	576	495	399	338	302	260	206	
		ON OFF	1175	1098	1024	947	883	823	764	703	640	567	
		OFF ON	1782	1744	1715	1700	1660	1619	1579	1510	1455	1413	
		ON ON	2145	2089	2058	2036	2020	2000	1971	1935	1890	1857	
CES	801005C	OFF OFF	803	719	631	540	471	337	298	265	217	174	
		ON OFF	1424	1385	1332	1284	1229	1176	1130	1078	1018	923	
		OFF ON	1820	1769	1726	1685	1642	1603	1557	1521	1478	1434	
		ON ON	2235	2185	2139	2108	2076	2032	2000	1964	1926	1896	

BLOWER PERFORMANCE DATA

*CES80

Cooling Airflow

MODEL		DIP SWITCHES S1-1, S1-2, S1-3	EXTERNAL STATIC PRESSURE, (INCHES WATER COLUMN)									
			0.1	0.2	0.3	0.4	0.5	0.6	0.7	0.8	0.9	1
			CFM	CFM	CFM	CFM	CFM	CFM	CFM	CFM	CFM	CFM
CES	800403A	OFF OFF OFF	668	650	600	555	507	459	411	352	291	259
		OFF ON ON	668	650	600	555	507	459	411	352	291	259
		ON OFF ON	668	650	600	555	507	459	411	352	291	259
		ON ON ON	668	650	600	555	507	459	411	352	291	259
		ON OFF OFF	785	754	736	690	650	604	565	527	482	438
		ON ON OFF	862	827	823	787	770	733	692	655	614	582
		OFF ON OFF	1104	1058	1020	1022	1013	981	952	918	887	855
		OFF OFF ON*	1348	1294	1261	1250	1229	1233	1205	1182	1156	1129
CES	800603A	OFF OFF OFF	716	647	592	541	478	420	368	296	245	198
		OFF ON ON	716	647	592	541	478	420	368	296	245	198
		ON OFF ON	716	647	592	541	478	420	368	296	245	198
		ON ON ON	716	647	592	541	478	420	368	296	245	198
		ON OFF OFF	1054	1002	951	906	861	820	797	754	704	660
		ON ON OFF	960	900	854	802	782	735	695	639	601	563
		OFF ON OFF	1160	1102	1055	1017	970	930	891	847	800	780
		OFF OFF ON*	1411	1356	1313	1272	1235	1198	1162	1127	1094	1063
CES	800804B	OFF OFF OFF	784	716	645	583	516	405	334	282	229	197
		OFF ON ON	784	716	645	583	516	405	334	282	229	197
		ON OFF ON	784	716	645	583	516	405	334	282	229	197
		ON ON ON	784	716	645	583	516	405	334	282	229	197
		ON OFF OFF	1295	1252	1203	1153	1114	1071	1022	981	931	883
		ON ON OFF	1401	1366	1320	1278	1236	1194	1153	1112	1070	1025
		OFF ON OFF	1596	1553	1512	1491	1450	1411	1388	1347	1312	1272
		OFF OFF ON*	1757	1713	1691	1664	1625	1588	1552	1522	1488	1447
CES	800805C	OFF OFF OFF	1171	884	667	576	495	399	338	302	260	206
		OFF ON ON	1171	884	667	576	495	399	338	302	260	206
		ON OFF ON	1171	884	667	576	495	399	338	302	260	206
		ON ON ON	1171	884	667	576	495	399	338	302	260	206
		ON OFF OFF	1175	1098	1024	947	883	823	764	703	640	567
		ON ON OFF	1436	1402	1362	1313	1244	1182	1132	1079	1025	965
		OFF ON OFF	1782	1744	1715	1700	1660	1619	1579	1510	1455	1413
		OFF OFF ON*	2145	2089	2058	2036	2020	2000	1971	1935	1890	1857
CES	801005C	OFF OFF OFF	803	719	631	540	471	337	298	265	217	174
		OFF ON ON	803	719	631	540	471	337	298	265	217	174
		ON OFF ON	803	719	631	540	471	337	298	265	217	174
		ON ON ON	803	719	631	540	471	337	298	265	217	174
		ON OFF OFF	1424	1385	1332	1284	1229	1176	1130	1078	1018	923
		ON ON OFF	1626	1574	1524	1479	1433	1400	1358	1309	1266	1218
		OFF ON OFF	1820	1769	1726	1685	1642	1603	1557	1521	1478	1434
		OFF OFF ON*	2235	2185	2139	2108	2076	2032	2000	1964	1926	1896

* Default Speed

BLOWER PERFORMANCE DATA

*MES80

Heating Airflow

MODEL		DIP SWITCHES S2-1, S2-2		EXTERNAL STATIC PRESSURE, (INCHES WATER COLUMN)												
				0.1		0.2		0.3		0.4		0.5		0.6	0.7	0.8
				CFM	RISE	CFM	RISE	CFM	RISE	CFM	RISE	CFM	RISE	CFM	CFM	CFM
MES	800403A	OFF OFF	658	45	603	49	550	54	495	N/A	441	N/A	388	331	286	
		ON OFF*	750	40	703	42	651	46	600	49	553	54	504	456	409	
		ON ON	923	32	865	34	824	36	802	37	759	39	715	674	631	
		OFF ON**	1138	N/A	1093	N/A	1057	N/A	1016	N/A	981	N/A	945	912	876	
MES	800603A	OFF OFF	681	N/A	617	N/A	566	N/A	511	N/A	458	N/A	405	358	311	
		ON OFF*	1151	39	1091	41	1050	42	1007	44	964	46	926	885	850	
		ON ON	964	46	906	49	856	52	810	55	788	56	745	702	662	
		OFF ON**	1328	N/A	1274	N/A	1231	N/A	1192	N/A	1155	N/A	1114	1081	1047	
MES	800603B	OFF OFF	752	N/A	678	N/A	608	N/A	547	N/A	474	N/A	403	335	263	
		ON OFF*	1330	33	1280	35	1229	36	1187	37	1146	39	1103	1061	1018	
		ON ON	1155	38	1100	40	1048	42	1002	44	952	47	907	861	816	
		OFF ON**	1418	N/A	1376	N/A	1333	N/A	1288	N/A	1248	N/A	1206	1163	1124	
MES	800604B	OFF OFF	757	N/A	683	N/A	618	N/A	558	N/A	486	N/A	414	354	278	
		ON OFF*	1320	34	1264	35	1217	37	1171	38	1131	39	1091	1049	1007	
		ON ON	1406	32	1358	33	1314	34	1267	35	1226	36	1205	1189	1147	
		OFF ON**	1590	N/A	1542	N/A	1499	N/A	1454	N/A	1418	N/A	1413	1390	1356	
MES	800803B	OFF OFF	706	N/A	631	N/A	563	N/A	486	N/A	404	N/A	338	280	232	
		ON OFF*	1231	48	1185	50	1136	52	1093	54	1049	56	1004	956	908	
		ON ON	1133	52	1009	59	956	62	903	N/A	856	N/A	804	774	722	
		OFF ON**	1160	51	1107	54	1060	56	1011	59	965	61	920	868	818	
MES	800804B	OFF OFF	743	N/A	668	N/A	599	N/A	522	N/A	432	N/A	366	312	258	
		ON OFF*	1408	42	1369	43	1319	45	1282	46	1242	48	1219	1193	1150	
		ON ON	1179	50	1123	53	1073	55	1025	58	972	61	949	924	869	
		OFF ON**	1574	N/A	1521	N/A	1481	N/A	1439	N/A	1398	N/A	1374	1335	1295	
MES	800804C	OFF OFF	822	N/A	754	N/A	652	N/A	566	N/A	499	N/A	428	346	294	
		ON OFF*	1352	44	1281	46	1218	49	1152	51	1076	55	1026	964	901	
		ON ON	1466	40	1399	42	1347	44	1290	46	1230	48	1170	1112	1054	
		OFF ON**	1669	N/A	1595	N/A	1527	N/A	1463	N/A	1407	N/A	1363	1336	1289	
MES	800805C	OFF OFF	822	N/A	754	N/A	652	N/A	566	N/A	499	N/A	428	346	294	
		ON OFF*	1352	44	1281	46	1218	49	1152	51	1076	55	1026	964	901	
		ON ON**	1669	N/A	1595	N/A	1527	N/A	1463	N/A	1407	N/A	1402	1363	1336	
		OFF ON**	1904	N/A	1832	N/A	1777	N/A	1727	N/A	1678	N/A	1630	1579	1523	
MES	801005C	OFF OFF	789	N/A	719	N/A	637	N/A	545	N/A	458	N/A	378	324	273	
		ON OFF*	1567	47	1516	49	1466	51	1423	52	1388	53	1342	1293	1243	
		ON ON	1424	52	1378	54	1330	56	1274	58	1226	60	1172	1119	1071	
		OFF ON**	1810	N/A	1764	N/A	1718	N/A	1682	N/A	1633	N/A	1596	1549	1510	
MES	801205D	OFF OFF	815	N/A	742	N/A	662	N/A	590	N/A	503	N/A	422	362	299	
		ON OFF*	1701	52	1641	54	1591	56	1544	58	1497	59	1453	1408	1372	
		ON ON	1434	62	1388	64	1336	N/A	1281	N/A	1230	N/A	1202	1178	1121	
		OFF ON**	1831	N/A	1770	N/A	1723	N/A	1677	N/A	1630	N/A	1590	1547	1506	

BLOWER PERFORMANCE DATA

***MES80**

Circulation Airflow

MODEL		DIP SWITCHES S2-3, S2-4	EXTERNAL STATIC PRESSURE, (INCHES WATER COLUMN)									
			0.1 CFM	0.2 CFM	0.3 CFM	0.4 CFM	0.5 CFM	0.6 CFM	0.7 CFM	0.8 CFM	0.9 CFM	1 CFM
MES	800403A	OFF OFF	658	603	550	495	441	388	331	286	238	198
		ON OFF	750	703	651	600	553	504	456	409	362	322
		OFF ON	1138	1093	1057	1016	981	945	912	876	836	744
		ON ON	1367	1321	1286	1255	1223	1190	1160	1133	1099	1068
MES	800603A	OFF OFF	681	617	566	511	458	405	358	311	265	215
		ON OFF	1151	1091	1050	1007	964	926	885	850	813	800
		OFF ON	1328	1274	1231	1192	1155	1114	1081	1047	1013	978
		ON ON	1389	1341	1295	1258	1221	1176	1140	1105	1076	1043
MES	800603B	OFF OFF	752	678	608	547	474	403	335	263	232	195
		ON OFF	1330	1280	1229	1187	1146	1103	1061	1018	977	936
		OFF ON	1418	1376	1333	1288	1248	1206	1163	1124	1085	1050
		ON ON	1465	1416	1382	1340	1299	1257	1219	1181	1142	1106
MES	800604B	OFF OFF	757	683	618	558	486	414	354	278	237	204
		ON OFF	1320	1264	1217	1171	1131	1091	1049	1007	965	923
		OFF ON	1590	1542	1499	1454	1418	1390	1356	1321	1282	1245
		ON ON	1804	1757	1712	1676	1637	1600	1566	1529	1501	1466
MES	800803B	OFF OFF	706	631	563	486	404	338	280	232	194	118
		ON OFF	1231	1185	1136	1093	1049	1004	956	908	862	835
		OFF ON	1160	1107	1060	1011	965	920	868	818	794	741
		ON ON	1402	1358	1317	1274	1234	1195	1154	1113	1069	1033
MES	800804B	OFF OFF	743	668	599	522	432	366	312	258	213	158
		ON OFF	1408	1369	1319	1282	1242	1193	1150	1109	1069	1025
		OFF ON	1574	1521	1481	1439	1398	1374	1335	1295	1259	1219
		ON ON	1810	1756	1711	1675	1637	1602	1569	1536	1500	1462
MES	800804C	OFF OFF	822	754	652	466	499	428	346	294	246	202
		ON OFF	1352	1281	1218	1152	1076	1026	964	901	833	790
		OFF ON	1669	1595	1527	1463	1407	1363	1336	1289	1238	1190
		ON ON	1904	1932	1777	1727	1678	1630	1579	1523	1469	1426
MES	800805C	OFF OFF	822	754	652	466	499	428	346	294	246	202
		ON OFF	1352	1281	1218	1152	1076	1026	964	901	833	790
		OFF ON	1904	1932	1777	1727	1678	1630	1579	1523	1469	1426
		ON ON	2202	2137	2080	2033	1985	1947	1903	1859	1791	1721
MES	801005C	OFF OFF	789	719	637	545	458	378	324	273	222	179
		ON OFF	1567	1516	1466	1423	1388	1342	1293	1243	1195	1146
		OFF ON	1810	1764	1718	1682	1633	1596	1549	1510	1466	1425
		ON ON	2111	2085	2052	2027	1988	1968	1949	1917	1876	1840
MES	801205D	OFF OFF	815	742	662	590	503	422	362	299	232	179
		ON OFF	1701	1641	1591	1544	1497	1453	1408	1372	1340	1295
		OFF ON	1831	1770	1723	1677	1630	1593	1547	1506	1464	1416
		ON ON	2226	2165	2126	2083	2048	2011	1983	1945	1905	1875

BLOWER PERFORMANCE DATA

*MES80

Cooling Airflow

MODEL		DIP SWITCHES S1-1, S1-2, S1-3	EXTERNAL STATIC PRESSURE, (INCHES WATER COLUMN)									
			0.1	0.2	0.3	0.4	0.5	0.6	0.7	0.8	0.9	1
			CFM	CFM	CFM	CFM	CFM	CFM	CFM	CFM	CFM	CFM
MES	800403A	OFF OFF OFF	658	603	550	495	441	388	331	286	238	198
		OFF ON ON	658	603	550	495	441	388	331	286	238	198
		ON OFF ON	658	603	550	495	441	388	331	286	238	198
		ON ON ON	658	603	550	495	441	388	331	286	238	198
		ON OFF OFF	750	703	651	600	553	504	456	409	362	322
		ON ON OFF	923	865	824	802	759	715	674	631	597	551
		OFF ON OFF	1138	1093	1057	1016	981	945	912	876	836	744
		OFF OFF ON*	1367	1321	1286	1255	1223	1190	1160	1133	1099	1068
MES	800603A	OFF OFF OFF	681	617	566	511	458	405	358	311	265	215
		OFF ON ON	681	617	566	511	458	405	358	311	265	215
		ON OFF ON	681	617	566	511	458	405	358	311	265	215
		ON ON ON	681	617	566	511	458	405	358	311	265	215
		ON OFF OFF	1151	1091	1050	1007	964	926	885	850	813	800
		ON ON OFF	964	906	856	810	788	745	702	662	622	588
		OFF ON OFF	1328	1274	1231	1192	1155	1114	1081	1047	1013	978
		OFF OFF ON*	1389	1341	1295	1258	1221	1176	1140	1105	1076	1043
MES	800603B	OFF OFF OFF	752	678	608	547	474	403	335	263	232	195
		OFF ON ON	752	678	608	547	474	403	335	263	232	195
		ON OFF ON	752	678	608	547	474	403	335	263	232	195
		ON ON ON	752	678	608	547	474	403	335	263	232	195
		ON OFF OFF	1330	1280	1229	1187	1146	1103	1061	1018	977	936
		ON ON OFF	1155	1100	1048	1002	952	907	861	816	789	741
		OFF ON OFF	1418	1376	1333	1288	1248	1206	1163	1124	1085	1050
		OFF OFF ON*	1465	1416	1382	1340	1299	1257	1219	1181	1142	1106
MES	800604B	OFF OFF OFF	757	683	618	558	486	414	354	278	237	204
		OFF ON ON	757	683	618	558	486	414	354	278	237	204
		ON OFF ON	757	683	618	558	486	414	354	278	237	204
		ON ON ON	757	683	618	558	486	414	354	278	237	204
		ON OFF OFF	1320	1264	1217	1171	1131	1091	1049	1007	965	923
		ON ON OFF	1406	1358	1314	1267	1226	1189	1147	1108	1070	1031
		OFF ON OFF	1590	1542	1499	1454	1418	1390	1356	1321	1282	1245
		OFF OFF ON*	1804	1757	1712	1676	1637	1600	1566	1529	1501	1466
MES	800803B	OFF OFF OFF	706	631	563	486	404	338	280	232	194	118
		OFF ON ON	706	631	563	486	404	338	280	232	194	118
		ON OFF ON	706	631	563	486	404	338	280	232	194	118
		ON ON ON	706	631	563	486	404	338	280	232	194	118
		ON OFF OFF	1231	1185	1136	1093	1049	1004	956	908	862	835
		ON ON OFF	1133	1009	956	903	856	804	774	722	661	606
		OFF ON OFF	1160	1107	1060	1011	965	920	868	818	794	741
		OFF OFF ON*	1402	1358	1317	1274	1234	1195	1154	1113	1069	1033

BLOWER PERFORMANCE DATA

*MES80

COOLING AIRFLOW DATA

MODEL		DIP SWITCHES S1-1, S1-2, S1-3	EXTERNAL STATIC PRESSURE, (INCHES WATER COLUMN)									
			0.1	0.2	0.3	0.4	0.5	0.6	0.7	0.8	0.9	1
			CFM	CFM	CFM	CFM	CFM	CFM	CFM	CFM	CFM	CFM
MES	800804B	OFF OFF OFF	743	668	599	522	432	366	312	258	213	158
		OFF ON ON	743	668	599	522	432	366	312	258	213	158
		ON OFF ON	743	668	599	522	432	366	312	258	213	158
		ON ON ON	743	668	599	522	432	366	312	258	213	158
		ON OFF OFF	1408	1369	1319	1282	1242	1193	1150	1109	1069	1025
		ON ON OFF	1179	1123	1073	1025	972	924	869	818	782	719
		OFF ON OFF	1574	1521	1481	1439	1398	1374	1335	1295	1259	1219
		OFF OFF ON*	1810	1756	1711	1675	1637	1602	1569	1536	1500	1462
MES	800804C	OFF OFF OFF	822	754	652	466	499	428	346	294	246	202
		OFF ON ON	822	754	652	466	499	428	346	294	246	202
		ON OFF ON	822	754	652	466	499	428	346	294	246	202
		ON ON ON	822	754	652	466	499	428	346	294	246	202
		ON OFF OFF	1352	1281	1218	1152	1076	1026	964	901	833	790
		ON ON OFF	1669	1595	1527	1463	1407	1363	1336	1289	1238	1190
		OFF ON OFF	1669	1595	1527	1463	1407	1363	1336	1289	1238	1190
		OFF OFF ON*	1904	1932	1777	1727	1678	1630	1579	1523	1469	1426
MES	800805C	OFF OFF OFF	822	754	652	466	499	428	346	294	246	202
		OFF ON ON	822	754	652	466	499	428	346	294	246	202
		ON OFF ON	822	754	652	466	499	428	346	294	246	202
		ON ON ON	822	754	652	466	499	428	346	294	246	202
		ON OFF OFF	1352	1281	1218	1152	1076	1026	964	901	833	790
		ON ON OFF	1669	1595	1527	1463	1407	1363	1336	1289	1238	1190
		OFF ON OFF	1904	1932	1777	1727	1678	1630	1579	1523	1469	1426
		OFF OFF ON*	2202	2137	2080	2033	1985	1947	1903	1859	1791	1721
MES	801005C	OFF OFF OFF	789	719	637	545	458	378	324	273	222	179
		OFF ON ON	789	719	637	545	458	378	324	273	222	179
		ON OFF ON	789	719	637	545	458	378	324	273	222	179
		ON ON ON	789	719	637	545	458	378	324	273	222	179
		ON OFF OFF	1567	1516	1466	1423	1388	1342	1293	1243	1195	1146
		ON ON OFF	1424	1378	1330	1274	1226	1172	1119	1071	1023	972
		OFF ON OFF	1810	1764	1718	1682	1633	1596	1549	1510	1466	1425
		OFF OFF ON*	2111	2085	2052	2027	1988	1968	1949	1917	1876	1840
MES	801205D	OFF OFF OFF	815	742	662	590	503	422	362	299	232	179
		OFF ON ON	815	742	662	590	503	422	362	299	232	179
		ON OFF ON	815	742	662	590	503	422	362	299	232	179
		ON ON ON	815	742	662	590	503	422	362	299	232	179
		ON OFF OFF	1701	1641	1591	1544	1497	1453	1408	1372	1340	1295
		ON ON OFF	1434	1388	1336	1281	1230	1178	1121	1063	1017	964
		OFF ON OFF	1831	1770	1723	1677	1630	1593	1547	1506	1464	1416
		OFF OFF ON*	2226	2165	2126	2083	2048	2011	1983	1945	1905	1875

*DEFAULT SPEED

*MES80 / *CES80 WIRING DIAGRAM

HIGH VOLTAGE!
 DISCONNECT ALL POWER BEFORE SERVICING OR INSTALLING THIS UNIT.
 MULTIPLE POWER SOURCES MAY BE PRESENT. FAILURE TO DO SO MAY
 CAUSE PROPERTY DAMAGE, PERSONAL INJURY OR DEATH.

WARNING

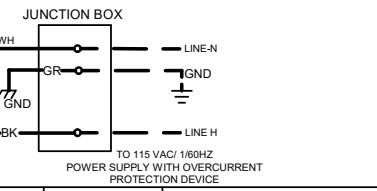
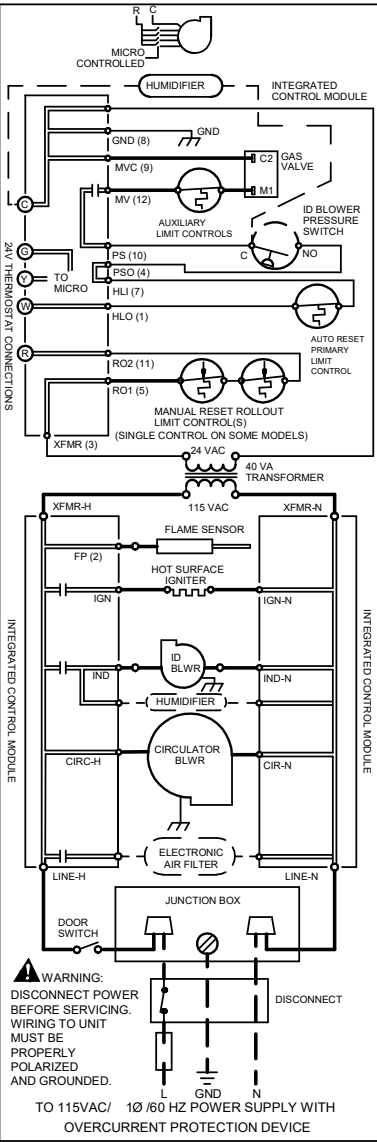
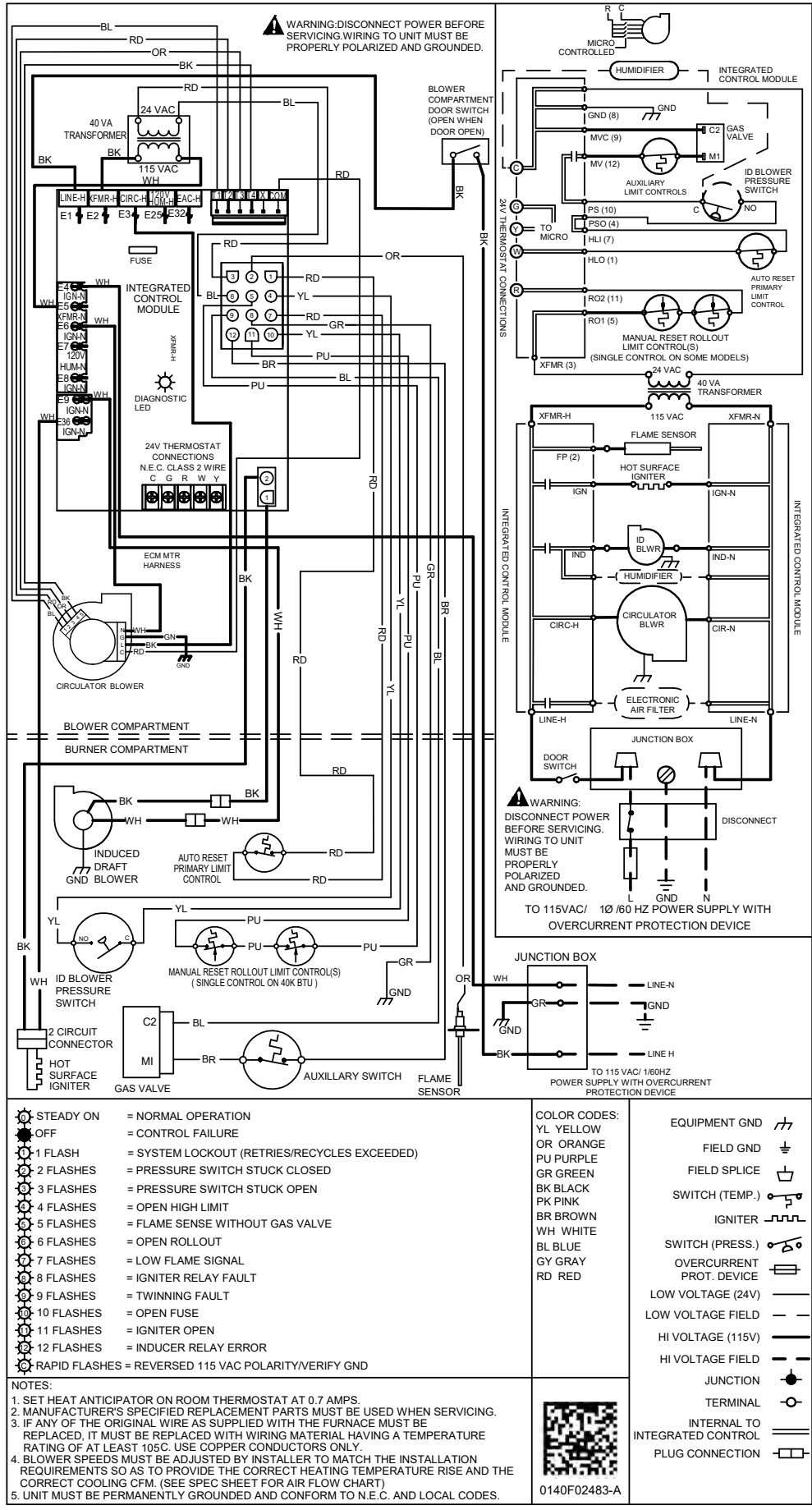

- STEADY ON = NORMAL OPERATION
- OFF = CONTROL FAILURE
- 1 FLASH = SYSTEM LOCKOUT (RETRIES/RECYCLES EXCEEDED)
- 2 FLASHES = PRESSURE SWITCH STUCK CLOSED
- 3 FLASHES = PRESSURE SWITCH STUCK OPEN
- 4 FLASHES = OPEN HIGH LIMIT
- 5 FLASHES = FLAME SENSE WITHOUT GAS VALVE
- 6 FLASHES = OPEN ROLLOUT
- 7 FLASHES = LOW FLAME SIGNAL
- 8 FLASHES = IGNITER RELAY FAULT
- 9 FLASHES = TWINNING FAULT
- 10 FLASHES = OPEN FUSE
- 11 FLASHES = IGNITER OPEN
- 12 FLASHES = INDUCER RELAY ERROR
- RAPID FLASHES = REVERSED 115 VAC POLARITY/VERIFY GND

NOTES:

- SET HEAT ANTICIPATOR ON ROOM THERMOSTAT AT 0.7 AMPS.
- MANUFACTURER'S SPECIFIED REPLACEMENT PARTS MUST BE USED WHEN SERVICING.
- IF ANY OF THE ORIGINAL WIRE AS SUPPLIED WITH THE FURNACE MUST BE REPLACED, IT MUST BE REPLACED WITH WIRING MATERIAL HAVING A TEMPERATURE RATING OF AT LEAST 105°C. USE COPPER CONDUCTORS ONLY.
- BLOWER SPEEDS MUST BE ADJUSTED BY INSTALLER TO MATCH THE INSTALLATION REQUIREMENTS SO AS TO PROVIDE THE CORRECT HEATING TEMPERATURE RISE AND THE CORRECT COOLING CFM. (SEE SPEC SHEET FOR AIR FLOW CHART)
- UNIT MUST BE PERMANENTLY GROUNDED AND CONFORM TO N.E.C. AND LOCAL CODES.

- COLOR CODES:
- YL YELLOW
 - OR ORANGE
 - PU PURPLE
 - GR GREEN
 - BK BLACK
 - PK PINK
 - BR BROWN
 - WH WHITE
 - BL BLUE
 - GY GRAY
 - RD RED

- EQUIPMENT GND
- FIELD GND
- FIELD SPICE
- SWITCH (TEMP.)
- IGNITER
- SWITCH (PRESS.)
- OVERCURRENT PROT. DEVICE
- LOW VOLTAGE (24V)
- LOW VOLTAGE FIELD
- HI VOLTAGE (115V)
- HI VOLTAGE FIELD
- JUNCTION
- TERMINAL
- INTERNAL TO INTEGRATED CONTROL
- PLUG CONNECTION



Wiring is subject to change. Always refer to the wiring diagram on the unit for the most up-to-date wiring.

THIS PAGE INTENTIONALLY LEFT BLANK

CUSTOMER FEEDBACK

We are very interested in all product comments.

Please fill out the feedback on one of the following links:

Goodman® Brand Products: (<http://www.goodmanmfg.com/about/contact-us>).

Amana® Brand Products: (<http://www.amana-hac.com/about-us/contact-us>).

You can also scan the QR code on the right for the product brand you purchased to be directed to the feedback page.



GOODMAN® BRAND



AMANA® BRAND

Product Registration

Thank you for your recent purchase. Though not required to get the protection of the standard warranty, registering your product is a relatively short process, and entitles you to additional warranty protection, except that failure by California and Quebec residents to register their product does not diminish their warranty rights.

For Product Registration please register by following this link:

Goodman® Brand Products: (<https://www.goodmanmfg.com/product-registration>).

Amana® Brand Products: (<http://www.amana-hac.com/product-registration>).

You can also scan the QR code on the right to be directed to the Product Registration Page.



GOODMAN® BRAND



AMANA® BRAND

19001 Kermier Rd.

Waller, TX 77484

www.goodmanmfg.com • www.amana-hac.com

© 2019 - 2020 Goodman Manufacturing Company, L.P.

Amana® is a registered trademark of Maytag Corporation or its related companies and is used under license. All rights reserved.