

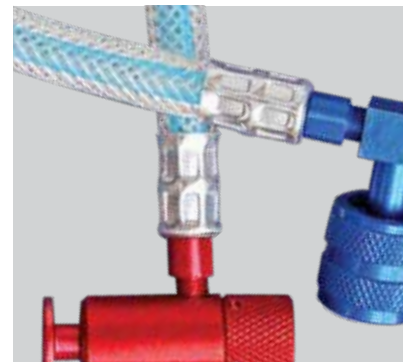

HVAC

PRODUCT CATALOG

ISSUE 24

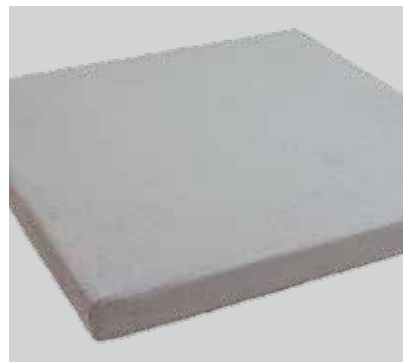

Simplify
your
Work.™

PADS	1
MOUNTING SYSTEMS	7
AIR MOVEMENT	21
HEATING PRODUCTS	27
CONDENSATE MANAGEMENT	35
GENERAL INDUSTRIAL	43
DEVCO	57
ELECTRICAL	87
TOOLS	119
PLUMBING	133
DUCTLESS	143
MAINTENANCE CHEMICALS	153
INLINE COMPONENTS	167
DISTRIBUTOR SUPPORT	185



PADS

Anti-Vibration Pads.....	6
CladLite® Lightweight Equipment Pads.....	3
E Lite® Plastic Equipment Pads.....	3
EcoPad™.....	5
Heat Pump Pad.....	6
The Black Pad®.....	5
The Hurricane Pad™.....	4
UltraLite® Lightweight Concrete Equipment Pads.....	2

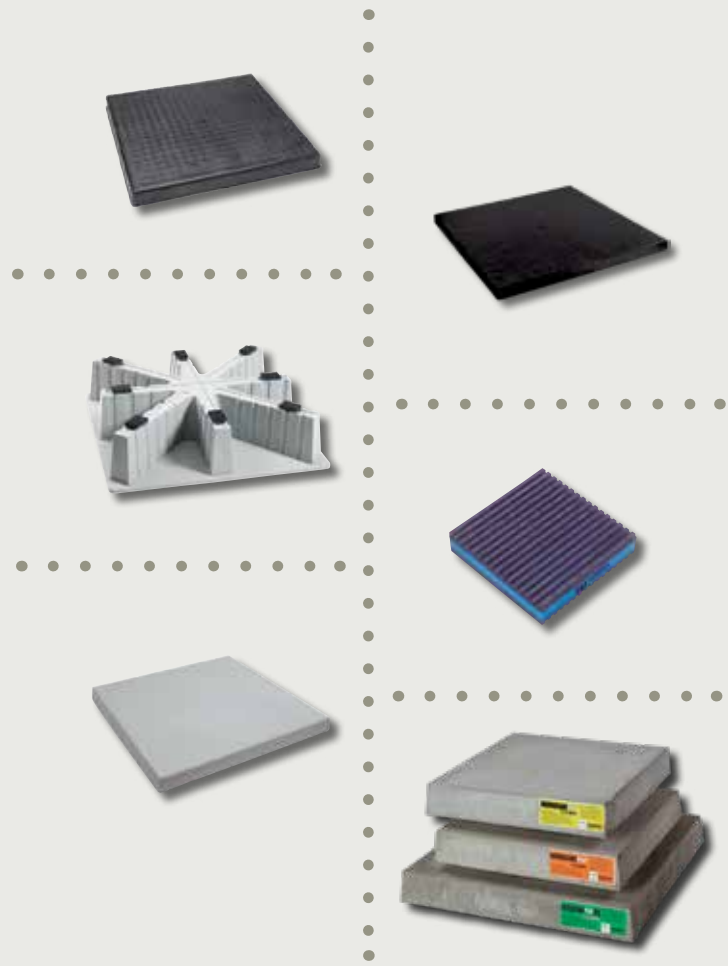

ULTRALITE® LIGHTWEIGHT CONCRETE EQUIPMENT PADS

3" UltraLite® Pads

A true concrete equipment pad at the weight of plastic (about 2.5 lbs. per square foot). UltraLite® is strengthened by miles of fiber in each square foot of fiber-cement coating. This fiber allows the pad to flex instead of cracking or breaking. The textured surface prevents the condensing unit or portable generator from sliding, and allows water drainage, while the engineered expanded polystyrene (EPS) core prevents warping and provides a solid bottom to resist settling. Unaffected by soil conditions, ultraviolet (UV) light, temperature extremes, and other weather conditions.



CATALOG NO.	SIZE	PAD WT.	PALLET QTY.	PALLET WT.	UOM	ORDER MULTIPLE
UC1636-3	16 X 36	18	30	565	EA	30
UC1838-3	18 X 38	20	30	625	EA	30
UC2424-3	24 X 24	18	15	295	EA	15
UC2436-3	24 X 36	26	15	415	EA	15
UC2442-3	24 X 42	28	15	445	EA	15
UC2448-3	24 X 48	30	15	475	EA	15
UC2626-3	26 X 26	17	15	280	EA	15
UC3030-3	30 X 30	23	15	370	EA	15
UC3040-3	30 X 40	33	15	520	EA	15
UC3232-3	32 X 32	26	15	415	EA	15
UC3237-3	32 X 37	29	15	460	EA	15
U3353-3	33 X 53	68	15	1,045	EA	15
UC3434-3	34 X 34	27	15	430	EA	15
UC3445-3	34 X 45	39	15	610	EA	15
UC3636-3	36 X 36	30	15	475	EA	15
UC3642-3	36 X 42	32	15	505	EA	15
UC3648-3	36 X 48	37	15	580	EA	15
U3650-3	36 X 50	62	15	955	EA	15
U3654-3	36 X 54	71	15	1,090	EA	15
U3660-3	36 X 60	49	15	760	EA	15
UC3842-3	38 X 42	35	15	550	EA	15
U3865-3	38 X 65	85	15	1,300	EA	15
U3870-3	38 X 70	113	15	1,720	EA	15
UC4040-3	40 X 40	34	15	535	EA	15
UC4042-3	40 X 42	36	15	565	EA	15
U4054-3	40 X 54	81	15	1,240	EA	15
U4550-3	45 X 50	82	15	1,255	EA	15

CATALOG NO.	SIZE	PAD WT.	PALLET QTY.	PALLET WT.	UOM	ORDER MULTIPLE
U4558-3	45 X 58	93	15	1,420	EA	15
U4848-3	48 X 48	85	15	1,300	EA	15
U4854-3	48 X 54	91	15	1,390	EA	15
U4866-3	48 X 66	108	15	1,645	EA	15
U5053-3	50 X 53	92	15	1,405	EA	15
U5056-3	50 X 56	97	15	1,480	EA	15
U5252-3	52 X 52	94	15	1,435	EA	15
U5557-3	55 X 57	109	15	1,660	EA	15

UltraLite® Earthquake Code Compliant Pads

Required nearly exclusively in Southern California, the UltraLite® pad is available for compliance with strict attachment provisions detailed in earthquake prone local building codes. UltraLite® earthquake code compliant pads are only available for sale in regions where local codes mandate installation of pads with these particular characteristics. Currently these locales include most of Southern California, portions of Washington, and portions of Oregon.



CATALOG NO.	SIZE	PAD WT.	PALLET QTY.	PALLET WT.	UOM	ORDER MULTIPLE
UC1838-3CA	18 X 38	18	15	295	EA	15
UC2424-3CA	24 X 24	14	15	235	EA	15
UC2436-3CA	24 X 36	22	15	355	EA	15
UC2448-3CA	24 X 48*	28	15	445	EA	15
UC2636-3CA	26 X 36	29	15	460	EA	15
UC3030-3CA	30 X 30	22	15	355	EA	15
UC3036-3CA	30 X 36	25	15	400	EA	15
UC3232-3CA	32 X 32	24	15	385	EA	15
UC3636-3CA	36 X 36	28	15	445	EA	15
UC3642-3CA	36 X 42	32	15	505	EA	15
UC3648-3CA	36 X 48	37	15	580	EA	15
UC4040-3CA	40 X 40	34	15	535	EA	15

3" UltraLite® Wedge Pads

The UltraLite® Wedge Pad is designed for Lennox condensing units.



CATALOG NO.	SIZE	PAD WT.	PALLET QTY.	PALLET WT.	UOM	ORDER MULTIPLE
UC3132-3L	31 X 32	23.33	15	350	EA	15
UC3539-3L	35 X 39	33.46	15	502	EA	15
UC4044-3L	40 X 44	37.53	15	563	EA	15

E LITE® PLASTIC EQUIPMENT PADS

E Lite's rugged design provides uniform and generous ribbing for optimum, self-leveling ground support without inserts. The result is a pad that is lightweight, but not too light. A subtle texture prevents unit slide and presents a classic appearance, which is enhanced by rounded edges and a concrete gray color. Each pad is molded with a size label and a symbol representing content of recycled material.

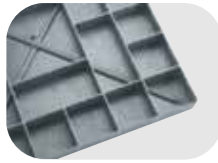

2" E Lite® Pads

The 2" thick E Lite® pad is the choice for plastic pads. Codes have moved toward requiring 3" pads, check local codes for your requirements.

CATALOG NO.	SIZE	PAD WT.	PALLET QTY.	PALLET WT.	UOM	ORDER MULTIPLE
EL2424-2	24 X 24	6	44	310	EA	44
EL2430-2	24 X 30	9	22	203	EA	22
EL2436-2	24 X 36	10	22	270	EA	22
EL2626-2	26 X 26	9	22	201	EA	22
EL3030-2	30 X 30	9	22	209	EA	22
EL3036-2	30 X 36	13	22	290	EA	22
EL3040-2	30 X 40	14	22	307	EA	22
EL3232-2	32 X 32	10	22	231	EA	22
EL3434-2	34 X 34	14	22	306	EA	22
EL3636-2	36 X 36	12	22	291	EA	22
EL3640-2	36 X 40	18	22	380	EA	22
EL3648-2	36 X 48	25	22	384	EA	22
EL3842-2	38 X 42	17	22	446	EA	22

3" E Lite® Pads

Codes have moved toward requiring 3" pads, check local codes for your requirements.



EL5658-3

CATALOG NO.	SIZE	PAD WT.	PALLET QTY.	PALLET WT.	UOM	ORDER MULTIPLE
EL1838-3	18 X 38	9	32	320	EA	32
EL2424-3	24 X 24	9	16	157	EA	16
EL2436-3	24 X 36	12	16	230	EA	16
EL2448-3	24 X 48	14	32	629	EA	32
EL3030-3	30 X 30	12	16	209	EA	16
EL3232-3	32 X 32	13	16	251	EA	16
EL3244-3	32 X 44	21	16	354	EA	16
EL3636-3	36 X 36	16	16	291	EA	16
EL3640-3	36 X 40	23	16	360	EA	16
EL3648-3	36 X 48	25	16	402	EA	16
EL3842-3	38 X 42	18	16	308	EA	16
EL3870-3	38 X 70	36	16	557	EA	16
EL4040-3	40 X 40	26	16	412	EA	16
EL4558-3	45 X 58	43	16	674	EA	16
EL4848-3	48 X 48	36	16	604	EA	16
EL5042-3	50 X 42	28	16	555	EA	16
EL5060-3	50 X 60	40	16	712	EA	16
EL5070-3	50 X 70	47	16	805	EA	16
EL5252-3	52 X 52	40	16	648	EA	16
EL5658-3	56 X 58	55	16	884	EA	16

CLADLITE® LIGHTWEIGHT CONCRETE EQUIPMENT PADS

Concrete surface and superior performance at 20% the weight of conventional concrete pads. The cladding provides superior resistance to sun, moisture and freeze-thaw conditions; the engineered expanded polystyrene (EPS) core is virtually impervious to water, soil conditions, fungus and bacteria. Large CladLite® pads are further strengthened by continuous steel reinforcement throughout the cladding. CladLite® is code approved for installation throughout the U.S.

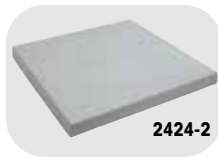

2424-2

3" CladLite® Pads

Used where codes have moved toward requiring 3" pads, check local codes for your requirements.

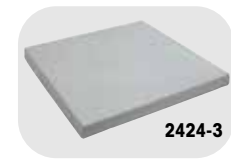

2424-3

2" CladLite® Pads

The 2" thick CladLite® pad is the choice for equipment pads. Codes have moved toward requiring 3" pads, check local codes for your requirements.

CATALOG NO.	SIZE	PAD WT.	PALLET QTY.	PALLET WT.	UOM	ORDER MULTIPLE
2424-2	24 X 24	30	25	780	EA	25
2436-2	24 X 36	50	25	1,275	EA	25
2442-2	24 X 42	57	25	1,450	EA	25
3030-2	30 X 30	36	25	925	EA	25
3036-2	30 X 36	43	25	1,093	EA	25
3040-2	30 X 40	60	25	1,525	EA	25
3143-2	31 X 43	70	25	1,775	EA	25
3232-2	32 X 32	44	25	1,125	EA	25
3434-2	34 X 34	51	25	1,300	EA	25
3636-2	36 X 36	63	25	1,598	EA	25
3640-2	36 X 40	71	25	1,798	EA	25
3648-2	36 X 48	88	25	2,220	EA	25
4147-2	41 X 47	103	25	2,600	EA	25

CATALOG NO.	SIZE	PAD WT.	PALLET QTY.	PALLET WT.	UOM	ORDER MULTIPLE
1636-3	16 X 36	48	20	985	EA	20
2424-3	24 X 24	43	20	877	EA	20
2436-3	24 X 36	60	20	1,215	EA	20
2448-3	24 X 48	84	20	1,695	EA	20
2626-3	26 X 26	50	20	1,015	EA	20
3030-3	30 X 30	62	20	1,255	EA	20
3036-3	30 X 36	73	20	1,487	EA	20
3040-3	30 X 40	94	20	1,905	EA	20
32-3	32 Round	67	20	1,365	EA	20
3232-3	32 X 32	68	20	1,379	EA	20
3237-3	32 X 37	73	20	1,485	EA	20
3636-3	36 X 36	80	20	1,633	EA	20
3640-3	36 X 40	97	20	1,969	EA	20
3648-3	36 X 48	109	20	2,207	EA	20
3660-3	36 X 60	163	15	2,470	EA	15
3842-3	38 X 42	120	20	2,417	EA	20
4042-3	40 X 42	170	10	1,605	EA	10
4550-3	45 X 50	184	15	2,785	EA	15
4558-3	45 X 58	203	15	3,070	EA	15
4766-3	47 X 66	219	10	2,215	EA	10
4848-3	48 X 48	184	15	2,785	EA	15
5053-3	50 X 53	197	15	2,980	EA	15

U.S. Patent number 4,505,449, and patents pending. ICBO No. PFC-5112.

THE HURRICANE PAD™ CONCRETE EQUIPMENT PADS

The Hurricane Pad™

Designed specifically for the hurricane prone regions of Florida and the Gulf Coast, The Hurricane Pad™ meets stringent local code requirements for wind resistance. Heavier than a normal concrete pad, this 4" pad provides sufficient weight to meet code. The Hurricane Pad meets the Florida Building Code Notice and can withstand winds up to 150 MPH. For certain taller equipment, The Hurricane T Class Pad™ is needed. Due to their extra weight, standard freight terms only apply for shipments to Florida. All other shipments are shipped FOB Conyers, GA.



The Hurricane T-Class Pad™

The Hurricane T Class Pad™ is even heavier than The Hurricane Pad™ and is designed to meet the higher wind loads of taller equipment. The taller the piece of equipment mounted to the pad, the greater the wind load on the pad. These heavier 4" pads provide sufficient weight to meet code for these taller condensing units. The Hurricane T-Class Pad meets the Florida Building Code Notice and can withstand winds up to 175 MPH. Due to their extra weight, standard freight terms for The Hurricane T Class Pad™ only apply for shipments to Florida. All other shipments are shipped FOB Conyers, GA.



CATALOG NO.	SIZE	PALLET QTY.	UOM	ORDER MULTIPLE
H1840-4	18 X 40	16	EA	16
H2424-4	24 X 24	16	EA	16
H2436-4	24 X 36	8	EA	8
H3030-4	30 X 30	8	EA	8
H3232-4	32 X 32	8	EA	8
H3636-4	36 X 36	8	EA	8
H3642-4	36 X 42	8	EA	8
H3648-4	36 X 48	8	EA	8
H3652-4	36 X 52	8	EA	8
H3654-4	36 X 54	8	EA	8
H3656-4	36 X 56	8	EA	8
H3672-4	36 X 72	8	EA	8
H3852-4	38 X 52	8	EA	8
H3865-4	38 X 65	8	EA	8
H3872-4	38 X 72	8	EA	8
H4040-4	40 X 40	8	EA	8
H4242-4	42 X 42	8	EA	8
H4558-4	45 X 58	8	EA	8
H5557-4	55 X 57	8	EA	8

CATALOG NO.	SIZE	PALLET QTY.	UOM	ORDER MULTIPLE
HT1840-4	18 X 24	10	EA	10
HT2436-4	24 X 36	5	EA	5
HT3030-4	30 X 30	5	EA	5
HT3232-4	32 X 32	5	EA	5
HT3636-4	36 X 36	5	EA	5
HT3648-4	36 X 48	5	EA	5
HT3842-4	38 X 42	5	EA	5
HT4040-4	40 X 40	5	EA	5
HT4242-4	42 X 42	5	EA	5
HT4558-4	45 X 58	5	EA	5

The Hurricane Pad™ MD

The new Hurricane Pad™ MD is the newest in concrete pad technology from DiversiTech. The Hurricane Pad MD is a solid concrete pad designed for the strict requirements of Miami Dade county. The Hurricane Pad MD meets the Florida Building Code Notice and can withstand winds up to 175 MPH. This pad is made from a minimum 7000PSI solid concrete. For Florida shipments only.



CATALOG NO.	SIZE	PALLET QTY.	UOM	ORDER MULTIPLE
HMD1840-4	18 X 40 X 4	5	EA	5
HMD3030-4	30 X 30 X 4	5	EA	5
HMD3636-4	36 X 36 X 4	5	EA	5
HMD3648-4	36 X 48 X 4	5	EA	5
HMD4040-4	40 X 40 X 4	5	EA	5

Potential Hurricane Winds Map

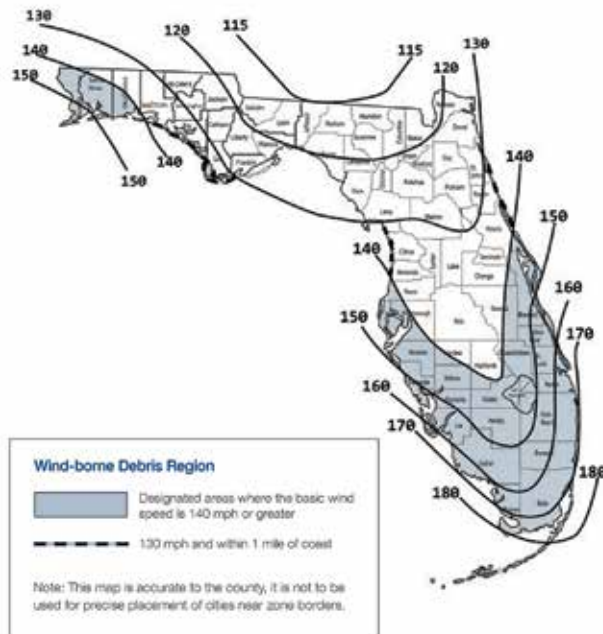

THE HURRICANE PAD™ CONCRETE EQUIPMENT PADS cont'd

The Hurricane Pad™ Tie Down Clips

Brackets used to secure condensing units to a pad or stand. These Florida approved clips use #8 self-tapping or self-drilling screws to secure to condenser.



CATALOG NO.	DESCRIPTION	UOM	ORDER MULTIPLE
TDC-4	The Hurricane Pad™ Attachment Bracket - 4", pack of 4	PK	1
TDC-6	The Hurricane Pad™ Attachment Bracket - 6", pack of 4	PK	1
TDC-8	The Hurricane Pad™ Attachment Bracket - 8", pack of 4	PK	1
TDC-10	The Hurricane Pad™ Attachment Bracket - 10", pack of 4	PK	1
TDC-12	The Hurricane Pad™ Attachment Bracket - 12", pack of 4	PK	1

THE BLACK PAD® BLACK PLASTIC EQUIPMENT PADS

The Black Pad® is an innovative equipment pad. The pad is extremely durable, resistant to ultraviolet light, and heavier than a completely plastic pad. The Black Pad® is suitable for use with pool pumps, filters, and heaters and complies with the 1997 Standard Swimming Pool Code sections 305.2 Mounting and section 405 Equipment Foundations and Enclosures.

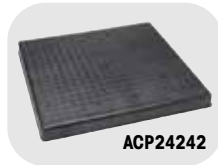

The Black Pad® — 3"

Used where codes have moved toward requiring 3" pads. Check local codes for your requirements.

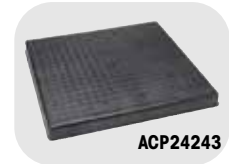

The Black Pad® — 2"

The 2" thick Black Pad® is the choice for plastic pads. Codes have moved toward requiring 3" pads, check local codes for your requirements.

CATALOG NO.	SIZE	PAD WT.	PALLET QTY.	PALLET WT.	UOM	ORDER MULTIPLE
ACP24242	24 X 24	10	24	231	EA	24
ACP30302	30 X 30	13	24	339	EA	24
ACP32322	32 X 32	16	24	387	EA	24
ACP36362	36 X 36	19	24	450	EA	24
ACP38422	38 X 42	25	24	549	EA	24

CATALOG NO.	SIZE	PAD WT.	PALLET QTY.	PALLET WT.	UOM	ORDER MULTIPLE
ACP24243	24 X 24	12	16	188	EA	16
ACP30303	30 X 30	20	16	274	EA	16
ACP32323	32 X 32	25	16	304	EA	16
ACP36363	36 X 36	23	16	367	EA	16
ACP36483	36 X 48	37	16	484	EA	16

ECOPAD™ BLACK PLASTIC EQUIPMENT PADS

An injection molded equipment pad created from 100% recycled materials to minimize environmental impact. It does not require any additional equipment for moving and handling. EcoPad™ is resistant to impact, ultra-violet degradation and weathering (virtually impervious to climatic variations), and will not crack, flake, or warp. Drillable to permit installation of refrigerant and electrical lines under and through the pad and to allow equipment to easily secure to the pad.



EcoPad™ — 3"

Used where codes have moved toward requiring 3" pads, check local codes for your requirements.



EcoPad™ — 2"

The 2" thick EcoPad™ is the choice for plastic pads. Codes have moved toward requiring 3" pads, check local codes for your requirements.

CATALOG NO.	SIZE	PAD WT.	PALLET QTY.	PALLET WT.	UOM	ORDER MULTIPLE
EP2424-2	24 X 24 X 2	6	24	166	EA	24
EP2436-2	24 X 36 X 2	10	24	227	EA	24
EP2626-2	26 X 26 X 2	9	24	226	EA	24
EP3030-2	30 X 30 X 2	9	24	224	EA	24
EP3036-2	30 X 36 X 2	13	24	294	EA	24
EP3232-2	32 X 32 X 2	10	24	260	EA	24
EP3434-2	34 X 34 X 2	14	24	339	EA	24
EP3636-2	36 X 36 X 2	12	24	299	EA	24
EP3648-2	36 X 48 X 2	19	24	476	EA	24
EP3842-2	38 X 42 X 2	17	24	430	EA	24

CATALOG NO.	SIZE	PAD WT.	PALLET QTY.	PALLET WT.	UOM	ORDER MULTIPLE
EP1838-3	18 X 38 X 3	9	32	292	EA	32
EP2424-3	24 X 24 X 3	9	16	150	EA	16
EP2436-3	24 X 36 X 3	12	16	210	EA	16
EP2448-3	24 X 48 X 3	14	32	645	EA	32
EP3030-3	30 X 30 X 3	12	16	212	EA	16
EP3232-3	32 X 32 X 3	13	16	220	EA	16
EP3434-3	34 X 34 X 3	21	16	291	EA	16
EP3636-3	36 X 36 X 3	16	16	271	EA	16
EP3640-3	36 X 40 X 3	23	16	360	EA	16
EP3648-3	36 X 48 X 3	25	16	433	EA	16
EP3842-3	38 X 42 X 3	18	16	311	EA	16
EP3870-3	38 X 70 X 3	36	16	545	EA	16
EP4040-3	40 X 40 X 3	26	16	406	EA	16
EP4558-3	45 X 58 X 3	43	16	725	EA	16
EP4848-3	48 X 48 X 3	36	16	591	EA	16
EP5042-3	50 X 42 X 3	28	16	511	EA	16
EP5060-3	50 X 60 X 3	40	16	705	EA	16
EP5070-3	50 X 70 X 3	47	16	808	EA	16
EP5252-3	52 X 52 X 3	40	16	633	EA	16
EP5658-3	56 X 58 X 3	55	16	884	EA	16

HEAT PUMP PAD™

Heat Pump Pad™

Provides an effective base for heat pump equipment installed in snowy climates. Rather than a combination of a typical 2" (or 3") equipment pad and 6" heat pump risers, the Heat Pump Pad™ provides a full 8" of elevation in a simple square footprint. The star pattern of the integral risers allows for installation of equipment with different size footprints up to 36" x 36". Also included are eight anti vibration pads uniquely designed to fit into the guide slots on the top of the integral risers. The base is sloped outward to allow for easy drainage of condensate or defrost cycle condensate when the outdoor coil is operating in heat pump mode. Nestable for efficient shipping, transportation, and warehousing. Injection molded from concrete gray, recycled polypropylene material, the Heat Pump Pad™ is environmentally friendly and designed to last longer than the equipment it supports. US Patent Number 7,891,635, and other patent(s) pending.



HP3636-8



Stackable!

CATALOG NO.	DESCRIPTION	UOM	ORDER MULTIPLE
HP3232-8	32" x 32" x 8"	EA	16
HP3636-8	36" x 36" x 8"	EA	16

ANTI-VIBRATION PADS

E.V.A. Anti-Vibration Pad

The latest generation in vibration dampening technology. The most effective vibration dampening pad available on the market. The EVA Pad was tested against other pads at four different vibration settings. In the most severe vibration extremes, the EVA Pad outperforms cork and rubber by a margin of greater than 3:1! This is due to the special composite foam center which is much more structurally sound than cork. It is not affected by oils or chemicals that can break down cork and is much more effective at vibration dampening than solid rubber. All this at a very competitive price. Designed to withstand 50 psi.

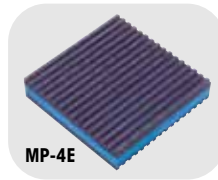

MP-4E

CATALOG NO.	DESCRIPTION	UOM	ORDER MULTIPLE
MP-2E	2" x 2" x 7/8" E.V.A. Pad	EA	48
MP-3E	3" x 3" x 7/8" E.V.A. Pad	EA	36
MP-4E	4" x 4" x 7/8" E.V.A. Pad	EA	24
MP-6E	6" x 6" x 7/8" E.V.A. Pad	EA	24
MP-12E	12" x 12" x 7/8" E.V.A. Pad	EA	12
MP-18E	18" x 18" x 7/8" E.V.A. Pad	EA	6

Rubber/Cork Anti-Vibration Pad

Highest quality elastomeric oil resistant padding. Designed to withstand 50 psi. The rubber pads are corrugated on both sides. The cork is laminated between two corrugated pads. Ideal for air conditioners, compressors, cooling towers, presses, machines, etc.

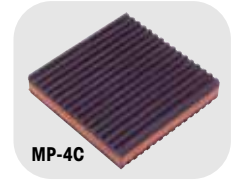

MP-4C

CATALOG NO.	DESCRIPTION	UOM	ORDER MULTIPLE
MP-2C	2" x 2" x 7/8" Rubber/Cork	EA	48
MP-3C	3" x 3" x 7/8" Rubber/Cork	EA	36
MP-4C	4" x 4" x 7/8" Rubber/Cork	EA	24
MP-6C	6" x 6" x 7/8" Rubber/Cork	EA	24
MP-8C	8" x 8" x 7/8" Rubber/Cork	EA	12
MP-12C	12" x 12" x 7/8" Rubber/Cork	EA	12
MP-18C	18" x 18" x 7/8" Rubber/Cork	EA	6

Rubber Anti-Vibration Pad

Highest quality elastomeric oil resistant padding. Designed to withstand 50 lbs. psi. The rubber pads are corrugated on both sides. Ideal for air conditioners, compressors, cooling towers, presses, machines, etc.

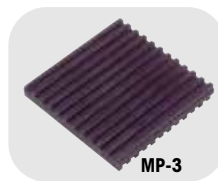

MP-3

CATALOG NO.	DESCRIPTION	UOM	ORDER MULTIPLE
MP-2	2" x 2" x 3/8" Rubber	EA	48
MP-3	3" x 3" x 3/8" Rubber	EA	36
MP-4	4" x 4" x 3/8" Rubber	EA	24
MP-6	6" x 6" x 3/8" Rubber	EA	24
MP-8	8" x 8" x 3/8" Rubber	EA	12
MP-12	12" x 12" x 3/8" Rubber	EA	12
MP-18	18" x 18" x 3/8" Rubber	EA	6

Iso-Cube Economy Anti-Vibration Pad

Natural rubber pads, designed to reduce vibration and noise emanating from refrigeration and air conditioning equipment. The circular design in each pad offers a suction cup effect, which eliminates the need to bolt the pads down. A standard 18" (46cm) pad is divided into eighty-one 2" (5cm) segments, each of which may be cut or torn to provide smaller pads. These 50 durometer pads will withstand a load of 180 psi with greater resiliency.



ISO-4

CATALOG NO.	DESCRIPTION	UOM	ORDER MULTIPLE
ISO-2	2" x 2" x 3/4" Iso-Cube	EA	24
ISO-4	4" x 4" x 3/4" Iso-Cube	EA	12
ISO-18	18" x 18" x 3/4" Iso-Cube	EA	6

MOUNTING SYSTEMS

Equipment Stands	11-12
Hanging Brackets.....	13-14
Heat Pump Risers	8
Hooks, Springs & Fixture Support.....	18
Mini-Split Stands	10-11
Mounting Accessories	13
Mounting Blocks	8-9
Mounting Brackets	9-10
Mounting Straps	19
Spring Fitting & Beam Clamps	17-18
Strut Clips & Clamps	14-16
Strut, Threaded Rod & Accessories.....	16-17

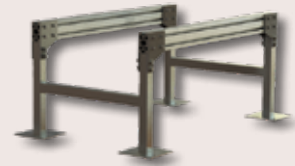
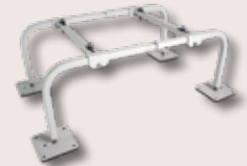

HEAT PUMP RISERS

One Piece Heat Pump Risers

Sturdy and stable, DiversiTech's Heat Pump Riser provides the desired elevation for condensers, heat pumps, and air handlers. The one piece, heavy duty plastic unit is manufactured in three heights. Butyl mastic on the top and bottom guarantees no slipping and reduced vibration and noise.



CATALOG NO.	DESCRIPTION	UOM	ORDER MULTIPLE
HPR-3	Riser – 3"	EA	48
HPR-3BL	Riser – 3", Black	EA	48
HPR-6	Riser – 6"	EA	36
HPR-6BL	Riser – 6", Black	EA	36
HPR-12	Riser – 12"	EA	16

Two Piece Heat Pump Risers

Sturdy and stable, DiversiTech's Heat Pump Riser provides the desired elevation for condensers, heat pumps, and air handlers. The one piece, heavy duty plastic unit is manufactured in two heights and an extension. Butyl mastic on the top and bottom guarantees no slipping and reduced vibration and noise.



CATALOG NO.	DESCRIPTION	UOM	ORDER MULTIPLE
HPR-3-2P	Two Piece Riser – 3"	EA	32
HPR-6-2P	Two Piece Riser – 6"	EA	16
HPR-3-2PG	Two Piece Black Riser – 3"	EA	32
HPR-6-2PG	Two Piece Black Riser – 6"	EA	16
HPR-EXT	4" Extension	EA	28

Adjustable Equipment Risers

Adjustable equipment risers easily adjust up or down as needed to secure equipment at the correct height. The large center barrel twists up from starting height of 5" to a max of 8". A separate top cap allows for raising or lowering the riser even with equipment already on it. Convenient height markings provided for reference.

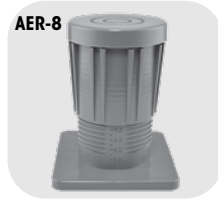

CATALOG NO.	DESCRIPTION	UOM	ORDER MULTIPLE
AER-8	Adjustable Equipment Riser - 8"	EA	4
AER-8BL	Adjustable Equipment Riser - 8" Black	EA	4

MOUNTING BLOCKS

Air Handler Block

Lightweight styrofoam block (white) provides A/C air handler support in attic installations.

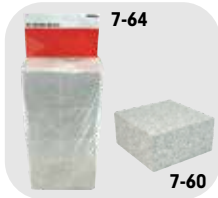

CATALOG NO.	DESCRIPTION	UOM	ORDER MULTIPLE
7-60	Air Handler Block 8" x 8" x 4"	EA	144
7-64	Air Handler Block 8" x 8" x 4", pack of 4	PK	4

Base Pad

Used as a mounting base when condensing units must be bolted down. Maximum load capacity is 220 lbs. per pad. Sliding rail design for easy and fast installation. Includes mounting bolts. Available in 17" lengths. Ivory color.



CATALOG NO.	DESCRIPTION	UOM	ORDER MULTIPLE
230-BP17W	17" Base Pad, pack of 2	PK	10

Furnace Mounting Blocks

Each furnace mounting block can support 40% more weight than competitive products – over 500 pounds! Easy peel and stick installation.



CATALOG NO.	DESCRIPTION	UOM	ORDER MULTIPLE
FB-1	Furnace Mounting Block	EA	72

Hef-T-Block™

Used as mounting bases when condensing units must be bolted down. Available in three lengths. Furnished complete with end caps and mounting bolts. Maximum load capacity is 440 pounds per mounting block. Installation temperature range from -4°F (-20°C) to 140°F (60°C). Hef T Blocks fit all mini split condensing units with a unique sliding rail feature.



CATALOG NO.	DESCRIPTION	UOM	ORDER MULTIPLE
230-MB14W	14" Hef-T-Block™ (White), pack of 2	PK	6
230-MB17W	17" Hef-T-Block™ (White), pack of 2	PK	6
230-MB24W	24" Hef-T-Block™ (White), pack of 2	PK	6
230-MB36W	36" Hef-T-Block™ (White), pack of 2	PK	2
230-MBCW	Hef-T-Block™ Replacement End Cap (White), pack of 4	PK	25

MOUNTING BLOCKS cont'd

Hef-T-Foot™

The Hef-T-Foot™ is used to support small pipework, runs of cable tray, or an alternative to supporting condensing units, air source heat pumps or a variety of outdoor equipment.

The Hef-T-Foot™ with strut comes in four lengths — 9.8", 15.7", 23.6", 39.4". They are manufactured from heavy duty recycled rubber and come complete with .8" x 1.6" galvanized steel strut adhered to the rubber with industrial adhesive. The rubber is strong and durable to allow standing water to flow under the foot.



FF-250-S



FF-250-UNI

Hef-T-Foot™ Installation Variants



Mini-Split Installation Kit

Comes with 2 feet & Mounting Hardware



CATALOG NO.	DESCRIPTION	UOM	ORDER MULTIPLE
FF-250-S	Hef-T-Foot™ – 9.8" with 1.6" x .8" strut	EA	1
FF-400-S	Hef-T-Foot™ – 15.7" with 1.6" x .8" strut	EA	1
FF-600-S	Hef-T-Foot™ – 23.6" with 1.6" x .8" strut	EA	1
FF-1000-S	Hef-T-Foot™ – 39.4" with 1.6" x .8" strut	EA	1
FF-250-UNI	Hef-T-Foot™ – 9.8" Universal	EA	1
FF-600-S-KIT	Mini-Split Installation Kit - 23.6"	EA	1
FF-1000-S-KIT	Mini-Split Installation Kit - 39.4"	EA	1

MOUNTING BRACKETS

Boiler Bracket

Newly redesigned mounting bracket for boilers and tankless water heaters. Available in wall mount or stand-alone configurations. Fits most boilers and tankless water heater designs. Bracket comes partially assembled for quick installations.



QSBB3000 QSBB4000



CATALOG NO.	DESCRIPTION	UOM	ORDER MULTIPLE
QSBB3000	Boiler Bracket - Wall Mount, Fixed Horizontal Arm: 32", 350 lbs capacity	EA	1
QSBB4000	Boiler Bracket - Free Standing, Fixed Horizontal Arm: 24", Adjustable Arm Height: 6" to 33", 350 lbs capacity	EA	1

Wall Brackets - Flat Wall

The QSWB1000 Condenser Wall Bracket provides a quick and safe mount that is perfectly designed for installation to a flat wall surface and can hold up to 500lbs. It also has the flexibility to be installed in the up and out orientation or down and out.



QSWB1000



CATALOG NO.	DESCRIPTION	UOM	ORDER MULTIPLE
QSWB1000	Mini Split Wall Bracket	EA	1

Hef-T-Bracket™

Used for supporting condensing units, Hef-T-Brackets (Type 2) feature a cross bar that is attached to a wall, and two L shaped brackets that are hooked and bolted into place on the cross bar. The condensing unit is mounted onto the L shaped brackets, and fastened using the bolts and anti vibration washers provided.

*Not approved for South Florida.



230-B2L

CATALOG NO.	DESCRIPTION	ARM LENGTH	LOAD RATING PER ARM	UOM	ORDER MULTIPLE
230-B2M	Hef-T-Bracket™ – Medium	18"	176#	EA	1
230-B2L	Hef-T-Bracket™ – Large	21"	176#	EA	1

Wall Brackets - Siding

This condenser wall bracket combines the installation flexibility of the QSWB1000 and the slider track mounting rail of the QSWB2000 to create a Heavy Duty, versatile mounting solution.



QSWB1100



CATALOG NO.	DESCRIPTION	UOM	ORDER MULTIPLE
QSWB1100	Wall Bracket w/Rails Light Dty	EA	1

Wall Bracket - Foundation Mount

This unique, 300lb condenser mounting bracket is designed to install directly to a foundation and still provides 7" clearance between the wall and the unit. The shelf depth is 19" and allows plenty of room for piping and service.



QSWB3000



CATALOG NO.	DESCRIPTION	UOM	ORDER MULTIPLE
QSWB3000	Wall Bracket w/Rails Heavy Dty	EA	1

MOUNTING BRACKETS cont'd

Wall Bracket - Siding

These hurricane rated wall brackets are strong, easy to install and are designed to be mounted into framing studs at 12" or 16" on center. These fit most mini-split models on the market today and provides the required distance between the wall and the condenser for optimal air flow. The QSWB2000 is rated for 300lbs and the heavy duty QSWB4000 is rated for 600lbs. Both models are also available in 316 stainless steel.



QSWB2000

QUICK-SLING®

by DiversiTech

HURRICANE RATED

CATALOG NO.	DESCRIPTION	UOM	ORDER MULTIPLE
QSWB2000	Wall Bracket w/Z Bend	EA	1
QSWB2000SS	Wall Bracket w/Z Bend	EA	1
QSWB4000	Wall Bracket w/Z Bend	EA	1
QSWB4000SS	Wall Bracket w/Z Bend	EA	1

Pitched Roof Mini-Split Mounting Bracket

The Quick-Sling® Pitched Roof Mini-Split Mounting Bracket is a fast and easy solution to mounting outdoor condensing units to a sloped roof.



QSPR1000

QUICK-SLING®

by DiversiTech

CATALOG NO.	DESCRIPTION	UOM	ORDER MULTIPLE
QSPR1000	Pitched Roof Bracket 300 lbs capacity, 9° - 45° sloped roofs	EA	1

Air Conditioner Brackets

These heavy duty 10ga thick steel AC brackets are perfect for hanging A/C condensers and heat pumps outside the home. Mount at any height to allow for easy maintenance under units. No need to wait for finished grade or landscaping prior to installation of AC unit. Pre punched holes for easy installation. Powder coated gray finish. Load rating 600 lbs. per pair.

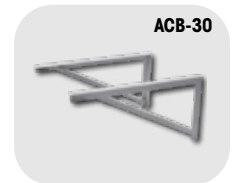

ACB-30

HURRICANE RATED

CATALOG NO.	DESCRIPTION	UOM	ORDER MULTIPLE
ACB-30	AC Mounting Bracket - 30", pack of 2	PK	1
ACB-36	AC Mounting Bracket - 36", pack of 2	PK	1
ACB-42	AC Mounting Bracket - 42", pack of 2	PK	1
ACB-48	AC Mounting Bracket - 48", pack of 2	PK	1
ACB-30-AL	AC Mounting Bracket, Aluminum - 30", pack of 2	PK	1
ACB-36-AL	AC Mounting Bracket, Aluminum - 36", pack of 2	PK	1
ACB-42-AL	AC Mounting Bracket, Aluminum - 42", pack of 2	PK	1
ACB-48-AL	AC Mounting Bracket, Aluminum - 48", pack of 2	PK	1

Ductless Cassette Hangers

The Ductless Cassette Hangers are an innovative bracket design that is made of light-weight aluminum to provide quick and easy installation of ductless cassettes. Only two sku's are compatible with most of the ductless cassettes on the market today. The built-in adjustability allows the alignment of the unit after it has been hung.



QSCH1000

QUICK-SLING®

by DiversiTech

CATALOG NO.	DESCRIPTION	UOM	ORDER MULTIPLE
QSCH1000	Ductless Cassette Hanger - Small Holds up to 200 lbs.	EA	1
QSCH2000	Ductless Cassette Hanger - Large Holds up to 200 lbs.	EA	1

MINI-SPLIT STANDS

Mini-Split Stands

Our Quick-Sling® Mini-Split Stands provide a safe, stable platform to mount your unit on. It keeps unit elevated above lawn mowers, weed whackers, pets, snow, and flooding. The elevated height allows for ease of installation, maintenance and service. **Now available in Stainless Steel.**

CATALOG NO.	DESCRIPTION	UOM	ORDER MULTIPLE
QSMS1200	Mini-Split Stand Thin - 12"	EA	1
QSMS1201	Mini-Split Stand Wide - 12"	EA	1
QSMS1201SS	Mini-Split Stand Wide - 12" Stainless Steel	EA	1
QSMS1800	Mini-Split Stand Thin - 18"	EA	1
QSMS1801	Mini-Split Stand Wide - 18"	EA	1
QSMS1801SS	Mini-Split Stand Wide - 18" Stainless Steel	EA	1
QSMS2400	Mini-Split Stand Thin - 24"	EA	1
QSMS2401	Mini-Split Stand Wide - 24"	EA	1
QSMS2401SS	Mini-Split Stand Wide - 24" Stainless Steel	EA	1



QSMS1201

QUICK-SLING®

by DiversiTech

MINI-SPLIT STANDS cont'd

Large Mini-Split Stands

The large Quick-Sling® Mini-Split Stand is made extra wide to accommodate larger equipment with up to 38" wide mounting hole locations. This stand comes with 2 mounting rails.



CATALOG NO.	DESCRIPTION	UOM	ORDER MULTIPLE
QSMS1204	Mini-Split Stand - Extra Wide - 2 Rails, 12" Tall	EA	1
QSMS1804	Mini-Split Stand - Extra Wide - 2 Rails, 18" Tall	EA	1
QSMS2404	Mini-Split Stand - Extra Wide - 2 Rails, 24" Tall	EA	1

3 Rail Large Mini-Split Stands

The large 3 Rail Mini-Split Stand is made extra wide to accommodate larger equipment with up to 38" wide mounting hole locations. This stand comes with 3 mounting rails.



CATALOG NO.	DESCRIPTION	UOM	ORDER MULTIPLE
QSMS1205	Mini-Split Stand - Extra Wide - 3 Rails, 12" Tall	EA	1
QSMS1805	Mini-Split Stand - Extra Wide - 3 Rails, 18" Tall	EA	1
QSMS2405	Mini-Split Stand - Extra Wide - 3 Rails, 24" Tall	EA	1

Mini-Split Super Stand

The Quick-Sling® Mini-Split Super Stand accommodates up to 6 outdoor mini-split condensing units on a single stand. With the addition of the extender kits condensing units can be added in increments of 2 per kit. The Mini-Split Super Stand is made from the same heavy-duty steel structural design as the VRF Super Stands.



CATALOG NO.	DESCRIPTION	UOM	ORDER MULTIPLE
QSMS3001-12	Mini-Split Super Stand, 6 systems, 12" High	EA	1
QSMS3001-18	Mini-Split Super Stand, 6 systems, 18" High	EA	1
QSMS3001-24	Mini-Split Super Stand, 6 systems, 24" High	EA	1
QSMS3001-12EXT	Mini-Split Super Stand Extender Kit, 2 systems, 12" High	EA	1
QSMS3001-18EXT	Mini-Split Super Stand Extender Kit, 2 systems, 18" High	EA	1
QSMS3001-24EXT	Mini-Split Super Stand Extender Kit, 2 systems, 24" High	EA	1

Mini-Split Dual Fan Stands

Our Quick-Sling® Mini-Split Dual Fan Stands provide a safe, stable platform to mount your unit on. It keeps unit elevated above lawn mowers, weed whackers, pets, snow, and flooding. The elevated height allows for ease of installation, maintenance and service.



CATALOG NO.	DESCRIPTION	UOM	ORDER MULTIPLE
QSMS1202	Mini-Split Dual Fan Stand - 12"	EA	1
QSMS1802	Mini-Split Dual Fan Stand - 18"	EA	1
QSMS2402	Mini-Split Dual Fan Stand - 24"	EA	1

Mini-Split Double Stack Stand

Our Quick-Sling® Mini-Split Double Stack Stand provide a safe, stable platform to mount your unit on. It keeps unit elevated above lawn mowers, weed whackers, pets, snow, and flooding. The elevated height allows for ease of installation, maintenance and service.



CATALOG NO.	DESCRIPTION	UOM	ORDER MULTIPLE
QSMS1203	Mini-Split Double Stack Stand	EA	1

EQUIPMENT STANDS

Aluminum Equipment Stands

These aluminum stands provide a safe, stable platform for mounting a wide variety of HVAC/R equipment. They keep the unit elevated above lawn mowers, weed trimmers, pets, snow and flooding. The elevated height allows for ease of installation, maintenance and service.



CATALOG NO.	DESCRIPTION	UOM	ORDER MULTIPLE
QSTD1403-AL	Aluminum Equipment Stand - 14 in. high	EA	1
QSTD1803-AL	Aluminum Equipment Stand - 18 in. high	EA	1
QSTD2403-AL	Aluminum Equipment Stand - 24 in. high	EA	1

Heat Pump Stand

Our Quick-Sling® Heat Pump Stand provides a safe stable platform to mount your unit on. Keep it elevated above lawn mowers, weed whackers, pets, snow, and flooding. Elevated height allows for ease of installation, service, and maintenance.



CATALOG NO.	DESCRIPTION	UOM	ORDER MULTIPLE
QSTD3000	Quick Heat Pump Stand, 18" Tall	EA	1
QSTD3000-12	Quick Heat Pump Stand, 12" Tall	EA	1

Vertical Air Handler Stand

Our Quick-Sling® Vertical Air Handler Stand fits all LG, Unico and Mitsubishi Air Handlers. It is adjustable left to right in 1" increments up to 6". 18" and 24" stands include 2 stability arms. 500 lbs Max Capacity.



QSTD4000
QUICK-SLING
 by DiversiTech

CATALOG NO.	DESCRIPTION	UOM	ORDER MULTIPLE
QSTD4000	12" Vert Air Hdler Std 19" Arm	EA	1
QSTD4001	12" Vert Air Hdler Std 23" Arm	EA	1
QSTD4002	12" Vert Air Hdler Std 27" Arm	EA	1
QSTD5000	18" Vert Air Hdler Std 19" Arm	EA	1
QSTD5001	18" Vert Air Hdler Std 23" Arm	EA	1
QSTD5002	18" Vert Air Hdler Std 27" Arm	EA	1
QSTD6000	24" Vert Air Hdler Std 19" Arm	EA	1
QSTD6001	24" Vert Air Hdler Std 23" Arm	EA	1
QSTD6002	24" Vert Air Hdler Std 27" Arm	EA	1

Vibration Isolation Strips for Mini-Split & VRF/VRV

These high-density elastometric-coated, molded and pre-compressed fiberglass strips are UV resistant and designed to provide vibration isolation and allow controlled movement in the fiber media.



QSAC5101



QSAC5201

QUICK-SLING
 by DiversiTech

CATALOG NO.	DESCRIPTION	UOM	ORDER MULTIPLE
QSAC5100	Mini-Split Vibration Isolation Strips - '00 for narrow mini-split stands	EA	1
QSAC5101	Mini-Split Vibration Isolation Strips - '01 for standard mini-split stands	EA	1
QSAC5102	Mini-Split Vibration Isolation Strips - '02 for two fan mini-split stands	EA	1
QSAC5104	Mini-Split Vibration Isolation Strips - '04 for 2-arm large mini-split stands	EA	1
QSAC5105	Mini-Split Vibration Isolation Strips - '01 for 3-arm large mini-split stands	EA	1
QSAC5200	Super Stand® Vibration Isolation Strips - 48 in.	EA	1
QSAC5201	Super Stand® Vibration Isolation Strips - 62 in.	EA	1
QSAC5202	Super Stand® Vibration Isolation Strips - 74 in.	EA	1

Air Handler Base – Heavy Duty Adjustable

Made of 14 gauge galvanized steel for excellent corrosion resistance and longevity. 22" high x 22" deep. Width is adjustable from 16" – 26". Supports up to 200 lbs.



6-HAB-BG

CATALOG NO.	DESCRIPTION	UOM	ORDER MULTIPLE
6-HAB-BG	Steel Air Handler Base	EA	1

Horizontal Air Handler Stand

Our Quick-Stand is made of 14-gauge square tubing. This not only cuts down on vibration but allows the stand to hold up to 500 lbs. Each leg individually extends in 1" increments using thumb screws & wing nuts for speed and versatility. Installs as low as 22" on flat or uneven surfaces.



QSTD1000
QUICK-SLING
 by DiversiTech

CATALOG NO.	DESCRIPTION	UOM	ORDER MULTIPLE
QSTD1000	Quick-Stand Heavy Duty	EA	1
QSTD2000	Quick-Stand Light Duty	EA	1

VRF/VRV Super Stand®

The New VRF/VRV Super Stand® Equipment Stands are now simpler to order, easier to size and compatible with more equipment model families.

- New sliding rail design allows infinite depth adjustments to fit most all VRF/VRV systems.
- New rail mounting slots align to all equipment mounting hole configurations.
- New Base and Extension models reduces number of model numbers making selecting and configuring the right stands quick and easy.

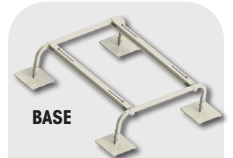

BASE

QSSB48-12



EXTENSION

QSSX48-12

QUICK-SLING
 by DiversiTech

CATALOG NO.	DESCRIPTION	UOM	ORDER MULTIPLE
QSSB48-12	Super Stand® Base Module, 12" High	EA	1
QSSB48-18	Super Stand® Base Module, 18" High	EA	1
QSSB48-24	Super Stand® Base Module, 24" High	EA	1
QSSX48-12	Super Stand® Extension Kit, 12" High	EA	1
QSSX48-18	Super Stand® Extension Kit, 18" High	EA	1
QSSX48-24	Super Stand® Extension Kit, 24" High	EA	1
QSSB62-12	Super Stand® Base Module, 12" High	EA	1
QSSB62-18	Super Stand® Base Module, 18" High	EA	1
QSSB62-24	Super Stand® Base Module, 24" High	EA	1
QSSX62-12	Super Stand® Extension Kit, 12" High	EA	1
QSSX62-18	Super Stand® Extension Kit, 18" High	EA	1
QSSX62-24	Super Stand® Extension Kit, 24" High	EA	1
QSSB74-12	Super Stand® Base Module, 12" High	EA	1
QSSB74-18	Super Stand® Base Module, 18" High	EA	1
QSSB74-24	Super Stand® Base Module, 24" High	EA	1
QSSX74-12	Super Stand® Extension Kit, 12" High	EA	1
QSSX74-18	Super Stand® Extension Kit, 18" High	EA	1
QSSX74-24	Super Stand® Extension Kit, 24" High	EA	1

MOUNTING ACCESSORIES

WeatherShield®

The Quick-Sling® WeatherShield™ protects outdoor ductless condensing units from weather damage. Quick-Sling® WeatherShield™ mounts directly to the mini-split and fits most sizes of equipment.



QSTD3000



CATALOG NO.	DESCRIPTION	UOM	ORDER MULTIPLE
QSW1000	Quick-Sling® WeatherShield™ - 31.5 - 41.5 in. x 6 - 12 in.	EA	1

Wind Baffles

These front mounted wind baffles are specifically designed for the Mitsubishi P-Series and PUMY outdoor units allow equipment operation in low ambient temperature conditions.



QSBF-PA03

CATALOG NO.	DESCRIPTION	UOM	ORDER MULTIPLE
QSBF-PA03	Wind Baffles	EA	1
QSBF-PA04	Wind Baffles	EA	1
QSBF-PA05	Wind Baffles	EA	1

A/C Security Cages

These DiversiTech manufactured, weather-resistant, steel mesh guards offer a safe solution from theft, vandalism and accidental damage of your expensive air conditioning and air source heat pump. Ideal for all manufacturers of air conditioners and heat pumps.



CG-U-S

CATALOG NO.	DESCRIPTION	UOM	ORDER MULTIPLE
CG-U-S	A/C Security Cage - Small, 27 in. x 41 in. x 23.6 in.	EA	1
CG-U-M	A/C Security Cage - Med. 45 in. x 41 in. x 23.6 in.	EA	1
CG-U-L	A/C Security Cage - Large, 63 in. x 41 in. x 23.6 in.	EA	1

Roof Bracket

The Quick-Sling Roof Bracket mounts to QSWB3000 or the QSMS1200, 1201, 1202, 1800, 1801, 1802, 2400, 2401 and protects the equipment from snow and freezing rain.



QSRB1000

CATALOG NO.	DESCRIPTION	UOM	ORDER MULTIPLE
QSRB1000	Roof Bracket	EA	1

HANGING BRACKETS

Quick-Sling® - Air Handler Hanging Bracket

Our Quick-Sling is made of 14-gauge square tubing. This not only cuts down on vibration but allows the stand to hold up to 400 lbs. Extension arms individually adjust in one inch increments using thumb screws & wing nuts for speed & versatility. Installs as high as 24" or as low as 48" on flat or pitched roofs.



QSLG2000



CATALOG NO.	DESCRIPTION	UOM	ORDER MULTIPLE
QSLG2000	Sling Bracket Heavy Duty 2 Arm	EA	1

Quick Swivel "U" Mount - Unit Heater Bracket

Our Quick Swivel is made of 14-gauge steel able to hold 200 lbs. The swivel allows for 360° rotation for setting the perfect direction of air flow.



QSWI1000



CATALOG NO.	DESCRIPTION	UOM	ORDER MULTIPLE
QSWI1000	Swivel "U" Mount w/H-Bracket	EA	1
QSWI2000	Swivel "U" Mount w/I-Bracket	EA	1

Quick Swivel Flush Mount w/"H" Bracket - Unit Heater Bracket

Our Quick Swivel is made of 14-gauge steel able to hold 200 lbs. The swivel allows for 360° rotation for setting the perfect direction of air flow.



QSWI3000



CATALOG NO.	DESCRIPTION	UOM	ORDER MULTIPLE
QSWI3000	Swivel Flush H Bracket	EA	1
QSWI3001	Swivel Flush H Bracket 36" Spd	EA	1
QSWI3002	Swivel Flush H Bracket 17" Spd	EA	1

Quick Swivel Flush Mount w/"I" Bracket - Unit Heater Bracket

Our Quick Swivel is made of 14-gauge steel able to hold 200 lbs. The swivel allows for 360° rotation for setting the perfect direction of air flow.



QSWI4000



CATALOG NO.	DESCRIPTION	UOM	ORDER MULTIPLE
QSWI4000	Swivel Flush w/ I Bracket	EA	1
QSWI5000	Swivel Flush Heavy Duty	EA	1
QSWI6000	Swivel Flush w/2 I Brackets	EA	1

HANGING BRACKETS cont'd

Quick-Sling® Accessories - Steel & Wood Beam Adapters



- The QSAC1000 (set of 4) & 1100 (set of 2) steel beam adapters are made out of aluminum & able to hold up to 250 lbs each.
- Each QSAC1000 is slotted to receive 3/8 threaded rod or C - clamps for easy mounting.
- The QSAC2000 (set of 4) & 2100 (set of 2) wood beam adapters are made of steel & are 12" long & 2" wide.
- Each of our adapters are able to hold up to 200 lbs.
- They have a 1.5" bend that simply clips over the wood joist. All the necessary hardware is provided.
- QSAC1000 and QSAC2000 adapts: QSLG1000 & QSLG2000
- QSAC1100 and QSAC2100 adapts: QSWI1000 & QSWI2000



CATALOG NO.	DESCRIPTION	UOM	ORDER MULTIPLE
QSAC1000	Adapters, Steel Pk of 4	EA	1
QSAC1100	Adapters, Steel Pk of 2	EA	1
QSAC2000	Adapters, Wood Pk of 4	EA	1
QSAC2100	Adapters, Wood Pk of 2	EA	1

STRUT CLIPS & CLAMPS

Rapid Positioning Clips

Rapid Positioning Clips fit directly into vertical and horizontal standard 1-5/8" strut channels. No tool required to install. Use for refrigeration, A/C tubing, PEX piping, and conduit support. They prevent cracked and fractured joints by allowing secured pipe to expand. The clips are UL2043 compliant and suitable for Plenum spaces. They are heat, light and U.V. stabilized for outdoor use. Available in 9 sizes to fit pipes with 1/4" to 1-5/8" outer diameter.



CATALOG NO.	TUBE O.D. (inch)	UOM	ORDER MULTIPLE
RPC-0014	1/4"	10 Pack	1
RPC-0038	3/8"	10 Pack	1
RPC-0012	1/2"	10 Pack	1
RPC-0058	5/8"	10 Pack	1
RPC-0034	3/4"	10 Pack	1
RPC-0078	7/8"	10 Pack	1
RPC-0118	1-1/8"	10 Pack	1
RPC-0138	1-3/8"	10 Pack	1
RPC-0158	1-5/8"	10 Pack	1

*Add "-100" to the end of part numbers for 100 pieces pack.

Studded Clips

Studded Clips fit directly onto 5/16" (M8) or 3/8" (M10) size threaded rods. No tool required to install. Use for refrigeration, A/C tubing, PEX piping, conduit, and cabling support. The clips are UL2043 compliant and suitable for Plenum spaces. They are heat, light and U.V. stabilized for outdoor use. Available in 11 sizes to fit pipes with 5/8" to 2-1/8" outer diameter.



CATALOG NO.	ROD SIZE	TUBE O.D. (inch)	UOM	ORDER MULTIPLE
SC08-15	5/16"	5/8"	10 Pack	1
SC08-20	5/16"	3/4"	10 Pack	1
SC08-22	5/16"	7/8"	10 Pack	1
SC08-25	5/16"	1"	10 Pack	1
SC08-28	5/16"	1-1/8"	10 Pack	1
SC08-32	5/16"	1-1/4"	10 Pack	1
SC08-35	5/16"	1-3/8"	10 Pack	1
SC08-40	5/16"	1-1/2"	10 Pack	1
SC08-42	5/16"	1-5/8"	10 Pack	1
SC08-50	5/16"	2"	10 Pack	1
SC08-54	5/16"	2-1/8"	10 Pack	1
SC10-15	3/8"	5/8"	10 Pack	1
SC10-20	3/8"	3/4"	10 Pack	1
SC10-22	3/8"	7/8"	10 Pack	1
SC10-25	3/8"	1"	10 Pack	1
SC10-28	3/8"	1-1/8"	10 Pack	1
SC10-32	3/8"	1-1/4"	10 Pack	1
SC10-35	3/8"	1-3/8"	10 Pack	1
SC10-40	3/8"	1-1/2"	10 Pack	1
SC10-42	3/8"	1-5/8"	10 Pack	1
SC10-50	3/8"	2"	10 Pack	1
SC10-54	3/8"	2-1/8"	10 Pack	1

*Add "-100" to the end of part numbers for 100 pieces pack.

STRUT CLIPS & CLAMPS cont'd

InsulClips

InsulClips fit directly into vertical and horizontal standard 1-5/8" strut channels. No tool required to install. Use for refrigeration, A/C tubing, PEX piping, conduit and cabling support. They are ideal for insulated pipes, to maintain vapor seal of the insulation and eliminates sweating. The clips are UL2043 compliant and suitable for Plenum spaces. They are heat, light and U.V. stabilized for outdoor use. Available in 11 sizes to fit pipes with 5/8" to 2-1/8" outer diameter.



CATALOG NO.	TUBE O.D. (inch)	UOM	ORDER MULTIPLE
IC00-15	5/8"	10 Pack	1
IC00-20	3/4"	10 Pack	1
IC00-22	7/8"	10 Pack	1
IC00-25	1"	10 Pack	1
IC00-28	1-1/8"	10 Pack	1
IC00-32	1-1/4"	10 Pack	1
IC00-35	1-3/8"	10 Pack	1
IC00-40	1-1/2"	10 Pack	1
IC00-42	1-5/8"	10 Pack	1
IC00-50	2"	10 Pack	1
IC00-54	2-1/8"	10 Pack	1

*Add "-100" to the end of part numbers for 100 pieces pack.

Flat Surface Adapter

The new Flat Surface Adapter is designed as a mounting base for RPC Clips, InsulClips, and Cable Tie Channel Clips. It easily screws onto any flat surface to provide a secure base for mounting. Made of a strong and lightweight polyamide (nylon) material.



- UL2043 compliant
- Includes slots for cable ties
- Fast and easy to install as a mounting base

CATALOG NO.	DESCRIPTION	UOM	ORDER MULTIPLE
RPC-FB	RPC Flat Surface Adapter	10 Pack	1
RPC-FB-100	RPC Flat Surface Adapter	10 Pack	1

Universal Strut Clamp

A highly versatile Universal Strut Clamp. Fits both pipe (rigid conduit)/IMC and thin walled tubing (EMT) in the corresponding sizes. Secures conduit to strut. Zinc Electro-Plate Finish.



CATALOG NO.	PINCH SIZE (inch)	O.D. (inch)	DESIGN LOAD (Lbs)	UOM	ORDER MULTIPLE
17532	1/2"	0.773"	400	EA	100
17533	3/4"	0.986"	600	EA	100
17534	1"	1.239"	600	EA	100
17535	1-1/4"	1.585"	600	EA	50
17536	1-1/2"	1.820"	800	EA	50
17537	2"	2.286"	800	EA	50

Cable Tie Channel Clips

Cable Tie Channel Clips fit directly into vertical and horizontal standard 1-5/8" strut channels. No tool required to install. Use for refrigeration, A/C tubing, PEX piping, conduit and cabling support. The clips are compliant with UL2043 and suitable for Plenum spaces. They are heat, light and U.V. stabilized for outdoor use. They accommodate PVC or metal cable ties up to a width of 11/16" (17mm). Three support base lengths available in 2" (50mm), 2-1/2" (65mm) and 3" (80mm).



CATALOG NO.	LENGTH	UOM	ORDER MULTIPLE
CTC-050	2"	10 Pack	1
CTC-065	2-1/2"	10 Pack	1
CTC-080	3"	10 Pack	1

*Add "-100" to the end of part numbers for 100 pieces pack.

Rigid Strut Clamp

Extra durable Zinc Electroplate Finished Strut Clamps to secure rigid and IMC conduits and pipes to struts. The Clamps with 2-1/2" through 8" diameter are suitable for rigid and EMT conduits.



CATALOG NO.	PINCH SIZE (inch)	O.D. (inch)	DESIGN LOAD (Lbs)	UOM	ORDER MULTIPLE
17515	3/4"	1.050"	600	EA	100
17516	1"	1.315"	600	EA	100
17518	1-1/2"	1.900"	800	EA	50
17519	2"	2.375"	800	EA	50
17520	2-1/2"	2.875"	800	EA	50
17521	3"	3.500"	800	EA	25
17522	3-1/2"	4.000"	1000	EA	25
17523	4"	4.500"	1000	EA	25

Cushion Clamps

An industry standard universal clamp that mounts to standard strut. Steel with electrochromate finish to resist corrosion. The lock nut has a nylon insert for a positive lock. The polymeric grommet withstands temperatures from -25°C to 125°C and resists the effects of most oils, chemicals, and industrial cleaning compounds.



CATALOG NO.	DESCRIPTION	UOM	ORDER MULTIPLE
538-1/4	Clamp Cushion - 1/4"	EA	25
538-3/8	Clamp Cushion - 3/8"	EA	25
538-1/2	Clamp Cushion - 1/2"	EA	25
538-5/8	Clamp Cushion - 5/8"	EA	25
538-3/4	Clamp Cushion - 3/4"	EA	25
538-7/8	Clamp Cushion - 7/8"	EA	25
538-1-1/8	Clamp Cushion - 1-1/8"	EA	10
538-1-3/8	Clamp Cushion - 1-3/8"	EA	10
538-1-5/8	Clamp Cushion - 1-5/8"	EA	10
538-2-1/8	Clamp Cushion - 2-1/8"	EA	10
538-2-5/8	Clamp Cushion - 2-5/8"	EA	10
538-3-1/8	Clamp Cushion - 3-1/8"	EA	10
538-4-1/8	Clamp Cushion - 4-1/8"	EA	10

STRUT CLIPS & CLAMPS cont'd

EMT Strut Clamp

Zinc Electroplate Finished Strut Clamps to secure EMT conduits and pipes to struts.



CATALOG NO.	PINCH SIZE (inch)	O.D. (inch)	DESIGN LOAD (Lbs)	UOM	ORDER MULTIPLE
17542	1/2"	0.706"	400	EA	100
17543	3/4"	0.922"	400	EA	100
17544	1"	1.163"	600	EA	100
17545	1-1/4"	1.510"	600	EA	50
17546	1-1/2"	1.740"	800	EA	50
17547	2"	2.197"	800	EA	50

STRUT, THREADED ROD AND ACCESSORIES

H-Frame Kits

Ideal for supporting ducts, pipes and electrical equipment. Kits include a pair of feet, brackets and hardware. 12.6" or 19.7" square feet available.



CATALOG NO.	DESCRIPTION	UOM	ORDER MULTIPLE
F-HF-320	H-Frame Kit - 12.5" foot	EA	100
F-HF-500	H-Frame Kit - 19.7" foot	EA	100

Channel Nuts

Spring Channel Nuts to attach a threaded rod to a strut. They are available with short springs for 13/16" & 1" channels and with regular springs for 1-3/8" & 1-5/8" channels. Zinc Electroplate finished.



CATALOG NO.	DESCRIPTION	THREAD	THICKNESS	UOM	ORDER MULTIPLE
17412	Channel Nut-Short Spring	1/4" - 20"	.25"	EA	100
17420	Channel Nut-Short Spring	3/8" - 16"	.37"	EA	100
17430	Channel Nut-Regular Spring	1/4" - 20"	.25"	EA	100
17438	Channel Nut-Regular Spring	3/8" - 16"	.37"	EA	100
17442	Channel Nut-Regular Spring	1/2" - 13"	.50"	EA	100

Strut to Beam Clamps

These clamps connect a beam to a strut installation. They are designed for a load up to 1200 lbs. when used in pairs. Zinc Electroplate Finish.



CATALOG NO.	DESCRIPTION	UOM	ORDER MULTIPLE
17462	Beam Clamp for 13/16" & 1-5/8" Channel	EA	25
17464	Beam Clamp for 2-7/16" & 3-1/4" Channel	EA	25

Channel Post Base for 1-5/8" Strut Channels

A Post Base secures a strut assembly to the floor or other surfaces. These Post Bases are made of galvanized steel and are available as 2 and 4 hole, heavy-duty, mounting option.



CATALOG NO.	DESCRIPTION	SIZE	UOM	ORDER MULTIPLE
17450	Post Base 2 Hole	4" x 6"	EA	5
17452	Post Base 4 Hole, Corner Orientation	6" x 6"	EA	5
17454	Post Base 4 Hole, Side Orientation	6" x 6"	EA	5

Connection Plates for 1-5/8" Strut Channels

Connection Plates are used to connect strut channels to each other. Splice plates allow to make extensions by connecting several channels while corner and angle plates make 90° connections. All plates are manufactured of steel with Zinc Electroplate finish, are 1/4" thick, and designed to be used with 1-5/8" strut channels.



CATALOG NO.	DESCRIPTION	UOM	ORDER MULTIPLE
17616	Square Washer 3/8"	EA	100
17618	Square Washer 1/2"	EA	100
17626	4 Hole Splice Plate	EA	25
17628	2 Hole Corner Angle	EA	50
17630	2 Hole Cross Corner Angle	EA	50
17632	3 Hole Corner Plate	EA	25
17633	3 Hole Cross Corner Angle	EA	50
17634	4 Hole 3 Way Corner Angle	EA	25
17636	4 Hole Tee Plate	EA	20
17638	2 Hole Open 45° Corner Angle	EA	25

Plastic White End Caps

Plastic White End Caps are used to cover the ends of a strut channel. Made of soft PVC material they provide a safe, smooth capping.

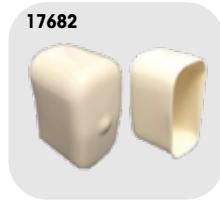

CATALOG NO.	DESCRIPTION	UOM	ORDER MULTIPLE
17682	Plastic White End Caps for 1 3/16" Channel	EA	100
17684	Plastic White End Caps for 1 5/8" Channel	EA	100

SPRING FITTINGS & BEAM CLAMPS

Beam Clamps

This fast-installing Beam Clamp fits beam flanges up to 1/2". It can be used with 1/4" and 3/8" threaded rod, "S" hooks, conduit hangers, electrical boxes, and #10-24 or 1/4"-20 bridle rings.



CATALOG NO.	DESCRIPTION	UOM	ORDER MULTIPLE
18016	Beam Clamp	EA	100

Flange Mount Conduit Assembly - Bottom Mount

The Assembly suspends a conduit from the bottom of a beam with a Posi-Lock mechanism. It installs with a hammer only and can pivot 360°. The rated static load limit is 75 lbs.



CATALOG NO.	DESCRIPTION	FLANGE THICKNESS	FITS CONDUIT	UOM	ORDER MULTIPLE
18200	Flange Mount Conduit Assembly - Bottom Mount - Posi-Lock	1/8"-1/4"	3/8"	EA	100
18050	Flange Mount Conduit Assembly - Bottom Mount - Posi-Lock	1/8"-1/4"	1/2" - 3/4"	EA	100
18202	Flange Mount Conduit Assembly - Bottom Mount - Posi-Lock	1/8"-1/4"	1	EA	100

Z Purlin Hanger

Z Purlin Angled Flange Hangers are used to attach threaded rod or hooks and straps to an angled Z purlin. The Hangers are holding up to 100 lbs.



CATALOG NO.	DESCRIPTION	FOR USE WITH	UOM	ORDER MULTIPLE
18180	Z Purlin Flange Hanger	Flange from 1/16" to 1/4"	EA	100
18160	Z Purlin Rod Hanger Assembly	1/4" Threaded Rod	EA	100
18161	Z Purlin Rod Hanger Assembly	3/8" Threaded Rod	EA	100

Spring Steel Beam Clamps

Spring Steel Clamps allow to suspend boxes, fixtures and bridle rings to 1/8" through 3/4" beam flanges.



CATALOG NO.	DESCRIPTION	FLANGE THICKNESS	STATIC LOAD	UOM	ORDER MULTIPLE
18123	Spring Steel Beam Clamps 1/4"-20 x 3/8" Stud	1/8" to 1/4"	75Lbs	EA	100
18124	Spring Steel Beam Clamps 1/4"-20 x 3/8" Stud	5/16" to 1/2"	75Lbs	EA	100
18018	Spring Steel Beam Clamps Universal	1/8" to 1/4"	200Lbs	EA	100

Flange Mount Conduit Assembly - Side Mount

The Assembly suspends a conduit from the side of a beam with a Posi-Lock mechanism. It installs with a hammer only and can pivot 360°. The rated static load limit is 25 lbs.



CATALOG NO.	DESCRIPTION	FLANGE THICKNESS	FITS CONDUIT	UOM	ORDER MULTIPLE
18231	Flange Mount Conduit Assembly - Side Mount - Posi-Lock	1/8"-1/4"	1/2" - 3/4"	EA	100
18232	Flange Mount Conduit Assembly - Side Mount - Posi-Lock	1/8"-1/4"	1"	EA	100
18240	Flange Mount Conduit Assembly - Side Mount - Posi-Lock	5/16"-1/2"	1/2" - 3/4"	EA	100

Spring Steel Cable Clip

The Cable Clip for MC, AC, or BX support 14-2, 14-3 & 12-2 cables in horizontal or vertical position. NOTE: The product is designed for positioning only, with no load rating.

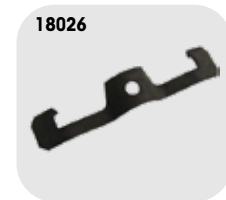

CATALOG NO.	DESCRIPTION	FOR USE WITH	UOM	ORDER MULTIPLE
18026	Spring Steel Cable Clips	OD's from .433 to .535	EA	100

SPRING FITTINGS & BEAM CLAMPS cont'd

Beam Clamp to Conduit Hanger Assembly

The Spring Steel Beam Clamp with a Pre-Installed Posi-Lock conduit hanger is available for bottom and side mount of conduits. The rated static load is 100 lbs. for the vertical, and 25 lbs. for the horizontal installation.



CATALOG NO.	DESCRIPTION	FITS CONDUITS	UOM	ORDER MULTIPLE
18130	Bottom Mount	1/2"-3/4"	EA	100
18140	Side Mount	1/2"-3/4"	EA	100

HOOKS, SPRINGS AND FIXTURE SUPPORT

Bridle Rings

Zinc-Plated Bridle Rings are a good support for communication cables & other low voltage uses. They are available as Bolt-On, commonly used with Beam Clamps, and as Screw-In, commonly used with Wooden Beams. The Cable Support Bridle Rings with saddle are a cost-effective alternative to expensive cable tray. Their wide surface saddle provides support without stress for Category 5, fiber-optic, and other sensitive voice/Datacom cables.



CATALOG NO.	DESCRIPTION	RING DIAMETER	THREAD	UOM	ORDER MULTIPLE
18421	Bridle Rings - Bolt-On	1/4" - 20"	1/4" -20	EA	100
18422	Bridle Rings - Bolt-On	2"	1/4" -20	EA	100
18425	Bridle Rings - Screw-On	1"	3/16"	EA	100
18426	Bridle Rings - Screw-On	1-1/2"	1/4"	EA	100
18427	Bridle Rings - Screw-On	2"	1/4"	EA	100
18058	Bridle Rings - Bolt-On with Saddle	2"	1/4"-20	EA	50
18060	Bridle Rings - Bolt-On with Saddle	4"	1/4"-20	EA	50

Box Stabilizer Support

This Stabilizer for electrical boxes is made of pre-galvanized steel. The box support is designed to be screwed to 2-1/2", 3-1/2" & 4" wood or metal studs.



CATALOG NO.	STUD SIZE	UOM	ORDER MULTIPLE
18370	2-1/2", 3-1/2"	EA	100
18052	2-1/2", 3-1/2", 4"	EA	100

J-Hooks

2" J Hooks for Datacom applications are a cost-effective alternative to expensive cable tray. Their wide base provides support without stress for Cat5, fiber-optic and other sensitive voice/Datacom cables. The continuous wide base radius supports the natural curve of cables and ensures eliminating kinks & bending. A cable wire retainer is supplied with every part. Its unique design eliminates the need for an attachment plate when stacked. These J-Hooks can be attached to a wide variety of structures using beam clamps, clips and many other components.



CATALOG NO.	DESCRIPTION	UOM	ORDER MULTIPLE
18056	J Hooks - 2", Screw Mount	EA	25

Box To T-Bar Fastener

A Snap-On 24" span box hanger with dual height adjustment that allows flush or 3/4" offset mounting of boxes. It is produced of pre-galvanized steel with spring steel hardware and has 1 BBC mounting clip with screw included.



CATALOG NO.	DESCRIPTION	UOM	ORDER MULTIPLE
18054	24" Span Box to T-Bar Fastener	EA	100

T-Bar Scissor Clips

This 2-piece T-Bar Scissor Clip mounts fixtures or boxes to a 1" T-bar. Includes a wing nut washer. Static Load Limit of 100 lbs.



CATALOG NO.	DESCRIPTION	UOM	ORDER MULTIPLE
18387	24" Span Box to T-Bar Fastener	EA	50

MOUNTING STRAPS

2 Hole PVC Pipe Straps

Designed to accommodate Schedule 40 PVC Conduit. The Heavy-Duty Polythene material resists deterioration from UV rays and breakage from extreme cold.



CATALOG NO.	TRADE SIZE	UOM	ORDER MULTIPLE
19490	1/2"	EA	100
19492	3/4"	EA	100
19494	1"	EA	100
19496	1-1/4"	EA	50
19498	1-1/2"	EA	50
19500	2"	EA	50
19501	2-1/2"	EA	25
19502	3"	EA	25
19503	4"	EA	25

1 Hole EMT Pipe Straps - Steel

Zinc Plated Steel Pipe Straps with a reinforced hole and rib for extra strength to secure EMT conduits. Easy Snap-On installation.



CATALOG NO.	TRADE SIZE	UOM	ORDER MULTIPLE
19400	1/2"	EA	100
19401	3/4"	EA	100
19402	1"	EA	100

2 Hole Rigid Pipe Straps - Steel

The 2 Hole Rigid Zinc Plated Steel Pipe Straps with reinforced holes and rib for extra strength are used to secure Rigid & IMC conduit. Easy Snap-On installation.



CATALOG NO.	TRADE SIZE	UOM	ORDER MULTIPLE
19436	1/2"	EA	X
19437	3/4"	EA	X
19438	1"	EA	25
19439	1-1/4"	EA	20
19440	1-1/2"	EA	10
19441	2"	EA	5
19443	3"	EA	1
19444	4"	EA	1
19445	5"	EA	1
19446	6"	EA	1

BX 1 Hole Strap

These one-hole pipe straps are ideal for hanging tubing, pipe, conduit and BX cable. They are made of pre-galvanized zinc plated steel with a reinforced rib for extra strength.



CATALOG NO.	CABLE SIZE	UOM	ORDER MULTIPLE
19463	BX: 14 - 2 Thru 10 - 3	EA	100

1 Hole Rigid Pipe Straps - Heavy Duty - Steel

The 1 Hole Rigid Pipe Strap is made of zinc plated steel with a reinforced hole and rib for heavy duty applications. It can be easily Snap-On installed and is used to secure Rigid & IMC conduit.



CATALOG NO.	TRADE SIZE	UOM	ORDER MULTIPLE
19426	1"	EA	25



RAPID POSITIONING CLIPS

The RPC line of mounting clips are cost-effective and time-saving solutions for refrigeration, A/C tubing, PEX piping, conduits and cabling support. Their unique, simple and effective one-piece design requires no tools and they are 20 times faster to install when compared to the traditional mounting clamps.



All RPC clips are made from durable polyamide material and have a wide working temperature range from -40°F to 284°F (-40°C to 140°C). They meet the UL2043 requirement for plenum rating and have the UL94 HB flame rating, suitable for use in air handling spaces.



AIR MOVEMENT

Dryer Duct, Vent Hose, Hose Clamps	23-24
Duct Strap, Ties, Clamps	24-25
Pure-Beam™ Ultraviolet Light	23
Tapes	25-26
Ventilation Products.....	22



VENTILATION PRODUCTS

Duct Fans

Features electrical junction box for UL and code compliant electrical connection. An efficient way to increase air circulation, keep room temperatures consistent, and lower heating and cooling costs. Metal construction, powerful no-maintenance motors and a one-use thermal fuse mean these fans will be up to the task for years. Straight forward installation into any 120V system with detailed instructions, templates, and diagrams. Available in many sizes. A great way to give slow vents a boost. Conforms to UL STD 507, Certified to CSA STD C22.2 #113

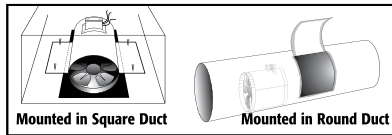

CATALOG NO.	DESCRIPTION	UOM	ORDER MULTIPLE
625-AF6	Duct Fan 6" dia., 240 CFM, 37W	EA	4
625-AF8	Duct Fan 8" dia., 420 CFM, 37W	EA	4
625-AF10	Duct Fan 10" dia., 650 CFM, 35W	EA	4
625-AF12	Duct Fan 12" dia., 975 CFM, 65W	EA	2
625-AF14	Duct Fan 14" dia., 1350 CFM, 65W	EA	1

Roof Flashing

Easy to install. The no-caulk flashing slips over vent stack and automatically adjusts to pipe size and roof angle. 24 gauge galvanized steel.



Oatey

CATALOG NO.	DESCRIPTION	UOM	ORDER MULTIPLE
5-11830	Roof Flashing – 1/2" – 3/4" – 1"	EA	12
5-11840	Roof Flashing – 1-1/4" – 1-1/2"	EA	12
5-11853	Roof Flashing – 2"	EA	12
5-11866	Roof Flashing – 3"	EA	12
5-11879	Roof Flashing – 4"	EA	12

Roof Louver

Unique interior louver design, eliminating the need for a screen. The square hood has been designed for maximum air movement. Large nailing flange for easy installation. U.L. Listed.



LESIE LOCKE

CATALOG NO.	DESCRIPTION	UOM	ORDER MULTIPLE
6-R50A	Roof Louver – Aluminum	EA	10

Flue Caps

PVC Flue Caps are an affordable way to protect today's high efficiency furnaces from dirt, moisture and other debris.

- Protection for high efficiency furnaces
- Universal flue cap fits 1.5", 2" and 3" PVC pipe
- Reduces draft inducer motor rust
- Helps to eliminate pressure switch service calls
- Resistant to UV radiation and oxidative degradation
- CSA approved for use in 90% AFUE heating applications



CATALOG NO.	DESCRIPTION	UOM	ORDER MULTIPLE
EC-1	E cap Flue Cap	EA	12

Smokeys

Smoke emitter cartridges provide effective, low cost leak testing of heat exchangers, air ducts, tanks and boilers. Visual air balancing of HVAC systems. Cartridges produce clean, non toxic, oil free smoke through chemical reaction. Use also for fire drills as well as the placement and testing of smoke alarms/ detectors.



CATALOG NO.	DESCRIPTION	UOM	ORDER MULTIPLE
14145	45 second burn time, 150 cu. ft., pack of 10	PK	1
14175	75 second burn time, 600 cu. ft., pack of 10	PK	1
14250	2-1/2 minute burn time, 1,100 cu. ft., pack of 5	PK	1
14340	4 minute burn time, 2,500 cu. ft., pack of 5	PK	1

Versa Cap® Flue and Hot Stack Caps

Non clogging positive draft design, recommended for flue or hot stack installation. Clamp fitting adjustable for all standard sizes. Aluminum model. U.L. Listed.



LESIE LOCKE

CATALOG NO.	PIPE O.D.	DOUBLE WALL	SINGLE WALL	J-M TRANS. SITE	HEIGHT/OVERALL DIAMETER	UOM	ORDER MULTIPLE
6-3050	2-7/8"-5"	3 and 4	3 and 4	3 and 4	4-1/2" x 6-5/8"	EA	12
6-5070	4-7/8"-7"	5 and 6	5 and 6	5 and 6	4-3/4" x 9-1/2"	EA	12
6-7090	6-7/8"-9"	7 and 8	7 and 8	7 and 8	5-7/8" x 11-5/8"	EA	12
6-9011	8-7/8"-11"	9 and 10	9 and 10	9 and 10	6-1/2" x 12-3/4"	EA	6
6-1200	11-7/8"-14-1/2"	12	12 and 14	12	8-11/16" x 17-9/16"	EA	2

Egg Crate Louvers – Air Return Diffusers

White polystyrene 1/2 in. open cell grid louvers are beneficial for air return.

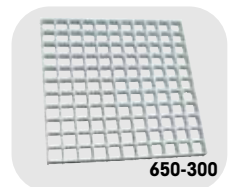

CATALOG NO.	DESCRIPTION	UOM	ORDER MULTIPLE
650-300	Egg Crate Louvers – 2' x 2' x 1/2"	EA	20
650-200	Egg Crate Louvers – 2' x 4' x 3/8"	EA	15
650-100	Egg Crate Louvers – 2' x 4' x 1/2"	EA	10

PURE BEAM™ ULTRAVIOLET LIGHT

Pure-Beam™ Ultraviolet Light

Pure Beam™ ultraviolet light is designed for HVAC air disinfection and surface irradiation. The 17 watt UV C lamp is a powerful tool for improved indoor air quality. Installs in the HVAC system or ductwork on either the return or supply air side of the furnace or air handler. DiversiTech's Pure Beam™ ultraviolet light provides a healthier environment in your home, thanks to the germicidal qualities of the UV light spectrum present in the Pure Beam™ light. Ultraviolet light deactivates the DNA of dust mites, bacteria, viruses and other pathogens and destroys their ability to multiply and cause disease. Placement of a Pure Beam™ light in an airstream or near a drain pan can help to decrease the air contamination of any home. Exposure to Pure Beam™ significantly reduces air contamination caused by fungus, mold, and viruses and can cleanse surfaces overcome by mold and slime. Overall size is 14 in. L x 2 in. W x 2 in. H for easy placement. Includes the UV lamp, a UL listed ceramic base, and mounting bracket.



UV-1

CATALOG NO.	DESCRIPTION	UOM	ORDER MULTIPLE
UV-1	Ultraviolet Light with 24 VAC elec. ballast	EA	1
UV-BULB	Replacement Bulb – 24V	EA	1

DRYER DUCT, VENT HOSE, HOSE CLAMPS

Aluminum Dryer Vent Hoods, Kits, and Fittings

Aluminum vent hood with flange plate.



650-001

CATALOG NO.	DESCRIPTION	UOM	ORDER MULTIPLE
650-001	4" Aluminum Hood	EA	24
650-002	3" Aluminum Hood	EA	24
650-003	4" Hood / 8' Tubing	EA	24
650-038	4" Aluminum Wide Mouth	EA	10

Plastic Wide Mouth Dryer Vent Hood

Hood, aluminum pipe and collar.



650-012

CATALOG NO.	DESCRIPTION	UOM	ORDER MULTIPLE
650-031	3" White Hood – Assembled	EA	12
650-012	4" White Hood – Assembled	EA	12
650-013	4" White Hood – Unassembled	EA	18
650-023	4" Brown Hood – Assembled	EA	12

Louvered Dryer Vent Hood

Louvered vent hoods are available with aluminum pipe and collar or hood only. Ideal for dryer and bathroom fan exhausts.



650-014

CATALOG NO.	DESCRIPTION	UOM	ORDER MULTIPLE
650-014	4" Hood Only – White	EA	12
650-016	4" Hood, Pipe and Collar – White (Assembled)	EA	12
650-017	4" Hood, Pipe and Collar – White (Unassembled)	EA	18
650-036	3" Hood, Pipe and Collar – White (Assembled)	EA	12

Dryer Vent Hose

High quality flexible white vinyl tubing. Available in 3in. or 4in. diameters. One 50ft roll per box.



650-005

CATALOG NO.	DESCRIPTION	UOM	ORDER MULTIPLE
650-005	Dryer Vent Hose – 3" x 50'	EA	1
650-006	Dryer Vent Hose – 4" x 50'	EA	1

Semi-Rigid Aluminum Duct

8ft. length compressed to 28in.



650-011

CATALOG NO.	DESCRIPTION	UOM	ORDER MULTIPLE
650-011	4" x 8' Flexible Aluminum Duct	EA	9
650-021	3" x 8' Flexible Aluminum Duct	EA	14
650-074	6" x 8' Flexible Aluminum Duct	EA	3

Metallic Duct – 5 Ply

Pure aluminum 5 ply multi layered flexible metallic duct. U.L. 181 Listed. Will contain a fire up to 265°F.



FUL0425

CATALOG NO.	DESCRIPTION	UOM	ORDER MULTIPLE
FUL0425	4" x 25' 5 Ply Metallic Duct	EA	4
FUL0625	6" x 25' 5 Ply Metallic Duct	EA	4

Dryer Hose Clamps

Available for 3 in. or 4in. dryer vent hose. Steel screw design or convenient spring action design.



650-008

650-010

CATALOG NO.	DESCRIPTION	UOM	ORDER MULTIPLE
650-008	Steel Screw Clamp for 4" Hose	EA	50
650-010	Spring Clamp for 4" Hose	EA	500

DRYER DUCT, VENT HOSE, HOSE CLAMPS cont'd

Periscope Connection Kit

For tight space duct venting. Contains one male snap lock fitting and one draw band with clamp. Adjustable 17in. to 28in..



CATALOG NO.	DESCRIPTION	UOM	ORDER MULTIPLE
650-020	4" Periscope Kit	EA	9

Metallic Duct – 2 Ply

2 ply metallic duct — aluminum outside, polyester inside. Ideal for bath fan ducting and all purpose venting.



CATALOG NO.	DESCRIPTION	UOM	ORDER MULTIPLE
FM0450	4" x 50' 2 Ply Metallic Duct	EA	1

DUCT STRAP, TIES, CLAMPS

Heavy Duty Cable Ties

6.6 nylon, the heavy duty duct straps feature smooth insertion, and a locking mechanism that gives ductwork a firm hold. Accommodates 7 to 15 inch duct. Tensioning tool for 32 in. plus allows operator to adjust strap to any desired tension.



CATALOG NO.	DESCRIPTION	UOM	ORDER MULTIPLE
7-P24	24" Long – Fits up to 6" Duct – 175 lb. Tensile	EA	50
7-P36	36" Long – Fits up to 10" Duct – 175 lb. Tensile	EA	50
7-P36B	36" Long – Black – Fits up to 10" Duct – 175 lb. Tensile	EA	50
7-P48	48" Long – Fits up to 14" Duct – 175 lb. Tensile	EA	50
7-P48B	48" Long – Black – Fits up to 14" Duct – 175 lb. Tensile	EA	25
7-L300	Tensioning Tool for 120-175 lb. Ties	EA	1

Hanging Wire

The 18 gauge galvanized can be used to hang HVAC duct work.



CATALOG NO.	DESCRIPTION	UOM	ORDER MULTIPLE
710-182G	2# Roll – 330' – 18 Gauge Galvanized	EA	8
710-185G	5# Roll – 830' – 18 Gauge Galvanized	EA	8

Plastic Hanger Strap

Flexible, non-conductive. 3/4 in. wide x .050 in. thick. Load tested to 120 lbs.



CATALOG NO.	DESCRIPTION	UOM	ORDER MULTIPLE
710-P100	3/4" x 100' Roll	EA	20

Strapping Hanger Iron

Galvanized 3/4 in. vent strapping, hanger iron, plumber's tape, pipe hanger tape and many other uses. 1/4 in. centers for bolts or nails.



CATALOG NO.	DESCRIPTION	UOM	ORDER MULTIPLE
710-A1710	Hanger Iron (Galv.) – 10' Rolls – 28 Gauge	EA	50
710-A1650	Hanger Iron (Galv.) – 50' Rolls – 28 Gauge	EA	10
710-A16100	Hanger Iron (Galv.) – 100' Rolls – 28 Gauge	EA	6

Duct Strap – Metallic – Roll

Galvanized duct strap in a convenient cardboard dispenser is not only easy to drill or nail, but also solid strapping. Plenum rated.



CATALOG NO.	DESCRIPTION	UOM	ORDER MULTIPLE
710-001	Metallic Duct Strap – 26 Gauge – 1" x 100'	EA	1
710-002	Metallic Duct Strap – 30 Gauge – 1" x 100'	EA	1
710-003	Metallic Duct Strap – 30 Gauge – 1-1/2" x 100'	EA	1
710-004	Metallic Duct Strap – 26 Gauge – 1-1/2" x 100'	EA	1
710-005	Metallic Duct Strap – 22 Gauge – 1" x 100'	EA	1

Plenum Duct Strap – UL Rated

Woven Polypropylene Hanging Straps meet the UL 2043 requirement and are suitable for use in air handling spaces. They have a high tensile strength of 400 lbs minimum and 460 lbs maximum. These straps are resistant to both abrasion and chemicals. They are easy to cut and staple to joists.



- Plenum rated, meets UL 2043 requirement
- High tensile strength
- Resistant to abrasion and chemicals
- Lightweight & easy to cut and staple

CATALOG NO.	DESCRIPTION	UOM	ORDER MULTIPLE
710-104	Plenum Duct Strap, Woven, 1-3/4" x 100 Yards – Black UL	EA	24
710-105	Plenum Duct Strap, Woven, 1-3/4" x 100 Yards – Silver UL	EA	24
710-106	Plenum Duct Strap, Woven, 3" x 100 Yards – Black UL	EA	8

DUCT STRAP, TIES, CLAMPS cont'd

Duct Strap – Woven Polypropylene

Webbed duct strap possessing high tensile and abrasion resistance. This can be used for flex duct as it is easy to cut and staple to joists. The product is chemical resistant and tested to meet UL Standard 2043. 710-104 through 710-106 are UL rated.



CATALOG NO.	DESCRIPTION	UOM	ORDER MULTIPLE
710-100	Duct Strap – 1-3/4" x 100 Yards – Black	EA	24
710-101	Duct Strap – 1-3/4" x 100 Yards – Silver	EA	24
710-102	Duct Strap – 3" x 100 Yards – Black	EA	8
710-103	Duct Strap – 3" x 100 Yards – Silver	EA	8

TAPES

Stick-E-Tape

Self adhesive aluminum tape with temperature range of 40 degree F to 200 degree F. Easily painted. Excellent vapor barrier; effective UV and water shield over urethane foam. Preferred duct and pipe wrap.

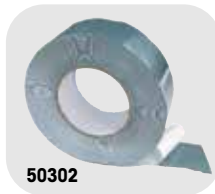

CATALOG NO.	DESCRIPTION	UOM	ORDER MULTIPLE
50302	Stick-E-Tape – AFT-701-2 – 2" x 50' Roll	EA	24

Aluminum Foil Tape

Prevents heating and cooling losses. Blocks odors and moisture. Easy to handle. Use for HVAC and refrigeration systems. 35 degree F to plus 260 degree F working temperatures. 3-5 year shelf life. Made in USA.



CATALOG NO.	DESCRIPTION	UOM	ORDER MULTIPLE
640-AF2	2" Aluminum Foil Tape – 50 yds.	EA	24
640-AF25	2-1/2" Aluminum Foil Tape – 50 yds.	EA	20
640-AF3	3" Aluminum Foil Tape – 50 yds.	EA	16

Flex Duct Tape

Specially designed to meet new UL181B FX code for flex duct. Higher adhesion and tack than traditional cloth duct tapes. Conformable, hand tearable foil; 3 mil thickness. 2 in. x 120 yds. Code identification printed on the tape. Acrylic adhesive for superior performance in extreme environments. (35°F to 260°F)



CATALOG NO.	DESCRIPTION	UOM	ORDER MULTIPLE
640-FD2S	Flex Duct Tape – Silver – 2"	EA	24
640-FD2B	Flex Duct Tape – Black – 2"	EA	24
640-FD3S	Flex Duct Tape – Silver – 3"	EA	16

Foil Scrim Kraft Tape

Non tearable, diamond patterned backing with an aggressive rubber based adhesive system for consistently dependable performance. Made in the USA.



CATALOG NO.	DESCRIPTION	UOM	ORDER MULTIPLE
640-FSK2	Foil Scrim Kraft Tape – 2" – 50 Yards	EA	24
640-FSK3	Foil Scrim Kraft Tape – 3" – 50 Yards	EA	16

TAPES cont'd

UL Listed Foil Tape

Unique acrylic adhesive for airtight bonds on joints and seams of fiberglass duct systems. Flexible, easy to use. Meets or exceeds performance standard AFLS 100 73 and UL 181 A.P.



CATALOG NO.	DESCRIPTION	UOM	ORDER MULTIPLE
640-UL25	UL 181 Listed Foil Tape – 2-1/2" – 60 Yards	EA	16
640-UL3	UL 181 Listed Foil Tape – 3" – 60 Yards	EA	16

Cloth Duct Tapes

High tack, excellent strength. Superior performance in sealing air handling systems. Heavy cloth content for easier tearing and additional strength. Made in the USA.

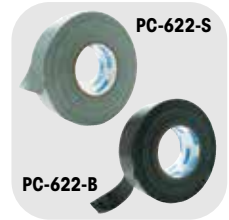

CATALOG NO.	DESCRIPTION	UOM	ORDER MULTIPLE
PC-622-S	2" x 60 Yards – Premium Grade Duct Tape – Silver	EA	24
PC-622-B	2" x 60 Yards – Premium Grade Duct Tape – Black	EA	24
PC-609-S	2" x 60 Yards – Industrial Grade Duct Tape – Silver	EA	24
PC-609-B	2" x 60 Yards – Industrial Grade Duct Tape – Black	EA	24
PC-600-S	2" x 60 Yards – Contractor Grade Duct Tape – Silver	EA	24
PC-600-B	2" x 60 Yards – Contractor Grade Duct Tape – Black	EA	24
PC-857	2" x 60 Yards – Metallized UL181B-FX Flex Duct Tape	EA	24

HEATING PRODUCTS

Black Steel Welded Nipples.....	32
Carbon Monoxide & Smoke Alarms.....	31
DiversiTech Gas Connectors.....	30
Dormont Gas Connectors and Valves.....	31
Heating Equipment Service Products.....	28
Malleable Black Iron Pipe Fittings.....	32-33
Tankless Water Heater Connection Kits.....	30
Tape.....	34
TrueStart® Hot Surface Igniters.....	28
TrueStart® Ignition Accessories.....	29
Vent Termination Kits.....	29



TRUESTART® HOT SURFACE IGNITERS

Wolverine® Universal Hot Surface Igniter

Wolverine® hot surface igniters feature protective, dynamic, and informative packaging. Wolverine® hot surface igniters are 100% tested and completely reliable. They are compatible with all OEM furnaces. Universal hot surface igniters allow a contractor to reduce truck stock and replace hundreds of OEM igniters with just one SKU.



CATALOG NO.	DESCRIPTION	UOM	ORDER MULTIPLE
IGN-2	Wolverine® Hot Surface Igniter by TrueStart®, Universal, Silicon Nitride	EA	6
IGN-2-6P	Wolverine® Hot Surface Igniter by TrueStart®, Universal, Silicon Nitride – Contractor Pack, pack of 6	PK	1

Universal Silicon Carbide Igniters

TrueStart® hot surface igniters feature protective, dynamic, and informative packaging. TrueStart™ hot surface igniters are 100% tested and completely reliable. They are compatible with all OEM furnaces. TrueStart® hot surface igniters are available as a universal silicon carbide igniter.



CATALOG NO.	DESCRIPTION	UOM	ORDER MULTIPLE
IGN-001	TrueStart® Hot Surface Igniter, Universal, Silicon Carbide	EA	6

Direct Replacement Igniters

TrueStart® hot surface igniters feature protective, dynamic, and informative packaging. TrueStart® hot surface igniters are 100% tested and completely reliable. They are compatible with all OEM furnaces. TrueStart® hot surface igniters are available as direct replacement for OEM silicon carbide igniters.



CATALOG NO.	DESCRIPTION	UOM	ORDER MULTIPLE
IGN-401	TrueStart® Hot Surface Igniter, Direct Replacement, Silicon Carbide for 41-401	EA	6
IGN-402	TrueStart® Hot Surface Igniter, Direct Replacement, Silicon Carbide for 41-402	EA	6
IGN-403	TrueStart® Hot Surface Igniter, Direct Replacement, Silicon Carbide for 41-403	EA	6
IGN-405	TrueStart® Hot Surface Igniter, Direct Replacement, Silicon Carbide for 41-405	EA	6
IGN-406	TrueStart® Hot Surface Igniter, Direct Replacement, Silicon Carbide for 41-406	EA	6
IGN-407	TrueStart® Hot Surface Igniter, Direct Replacement, Silicon Carbide for 41-407	EA	6
IGN-408	TrueStart® Hot Surface Igniter, Direct Replacement, Silicon Carbide for 41-408	EA	6
IGN-409	TrueStart® Hot Surface Igniter, Direct Replacement, Silicon Carbide for 41-409	EA	6
IGN-410	TrueStart® Hot Surface Igniter, Direct Replacement, Silicon Carbide for 41-410	EA	6
IGN-412	TrueStart® Hot Surface Igniter, Direct Replacement, Silicon Carbide for 41-412	EA	6

HEATING EQUIPMENT SERVICE PRODUCTS

Gas Equipment Service Tools

The GDK4080 is a complete set of high quality, small diameter precision gauging drills used to clean and enlarge gas orifices, burners and carburetor jets. It contains 41 commonly used gauging drills with handles, sizes from #40 to #80. A tapered broach with handle (GB3020) is also included.



CATALOG NO.	DESCRIPTION	UOM	ORDER MULTIPLE
GDK4080	Gauging Kit Drills, #40-80 set	EA	1
GB3020	Broach 3015 with handle	EA	1

TRUESTART® IGNITION ACCESSORIES

TrueStart® Flame Sensors

TrueStart® flame sensors are a direct replacement for OEM flame sensors. They are easy to install with matching flame rod length and bending angles. Model options are available for Carrier®/BDP, Lennox, Goodman/Amana, Rheem/Ruud, JCI/York, and Trane systems.



CATALOG NO.	DESCRIPTION	UOM	ORDER MULTIPLE
900-1	TrueStart® FLAME SENSOR replaces Robertshaw 10-760, White-Rodgers 760-401, Packard PFS401, Supco FLS401, MARS 67970, SIC SP-103	EA	1
900-3	TrueStart® FLAME SENSOR replaces Carrier®/Bryant LH33WZ516, LH680013	EA	1
900-4	TrueStart® FLAME SENSOR replaces Carrier®/Bryant LH33WZ517, LH33WZ511, LH33WZ515, LH680012, LH680014	EA	1
900-5	TrueStart® FLAME SENSOR replaces Carrier® LH33WZ518	EA	1
900-6	TrueStart® FLAME SENSOR replaces Carrier® LH33WZ520	EA	1
900-8	TrueStart® FLAME SENSOR replaces Lennox® 28M9701, 20467102	EA	1
900-9	TrueStart® FLAME SENSOR replaces Lennox® 44745-001, 44745001, R44745-001, 98M8701	EA	1
900-10	TrueStart® FLAME SENSOR replaces Goodman/Amana O130F0001, B1172606, 20488501, L38-035, L38035	EA	1
900-11	TrueStart® FLAME SENSOR replaces Rheem/Ruud 62-23543-01 and 62-23543-03	EA	1
900-14	TrueStart® FLAME SENSOR replaces Trane SEN491, SEN1114, SEN441, SENO441	EA	1
900-15	TrueStart® FLAME SENSOR replaces JCI/York 024-35354-000, 025-35354-700, S1-02527773000, S1-02527773700	EA	1
900-16	TrueStart® FLAME SENSOR replaces JCI/York 025-30788-000, 025-30788-700, S1-02530788700	EA	1
900-17	TrueStart® FLAME SENSOR replaces JCI/York S1-2702-311P, 2702-311P, 2702-311	EA	1

VENT TERMINATION KITS

Concentric Vents

Concentric vents make it easier to have a two pipe installation for high efficiency furnaces. These vents simplify installation and only require one hole through the wall or roof where the pipes terminate. Without using these vents, the installation would require cutting two holes through the home, one for each pipe. These vents save time and money by reducing the amount of work required. Available in 2", 3" or 4" intake vent sizes.

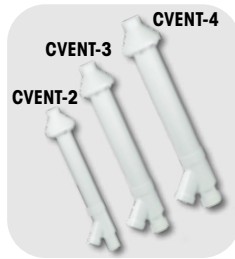

CATALOG NO.	DESCRIPTION	UOM	ORDER MULTIPLE
CVENT-2	2" Concentric Vent	EA	1
CVENT-3	3" Concentric Vent	EA	1
CVENT-4	4" Concentric Vent	EA	1
CVENTCAP2	Replacement cap for CVENT-2	EA	1
CVENTCAP3	Replacement cap for CVENT-3	EA	1
CVENTCAP4	Replacement cap for CVENT-4	EA	1
CVS-2	Vent screen for CVENT-2	EA	1
CVS-3	Vent screen for CVENT-3	EA	1
CVENT-2AB	Accelerator Bushing for 2" CVENT	EA	1

Horizontal Vent Termination Kits

Horizontal vent kits for use in venting high efficiency fossil fuel appliances. The low profile kit hides the vent from view.



CATALOG NO.	DESCRIPTION	UOM	ORDER MULTIPLE
HVENT-2	Horizontal Termination Kit - 2 inch	EA	6
HVENT-3	Horizontal Termination Kit - 3 inch	EA	6

Concentric Vent Flexible Installation

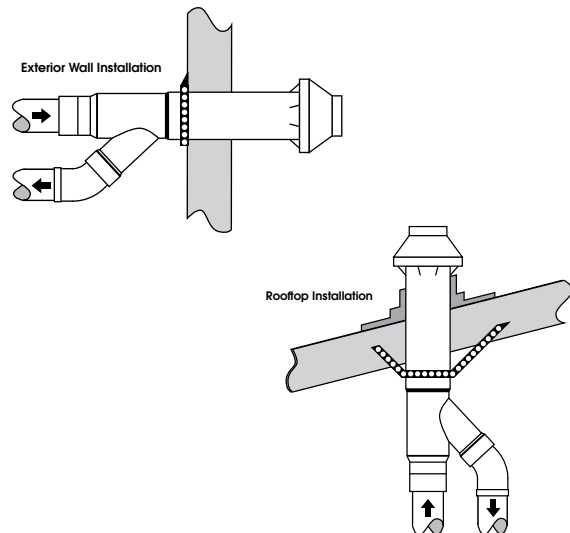

Extended Lengths for Concentric Vents

Concentric vents make it easier to have a two-pipe installation for high efficiency furnaces. These vents simplify installation and only require one hole through the wall or roof where the pipes terminate. Without using these vents, the installation would require cutting two holes through the home, one for each pipe. These vents save time and money by reducing the amount of work required. The extended length of these vents help to maintain clearance above the anticipated snow level to meet local code requirement.

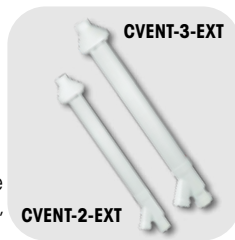

CATALOG NO.	DESCRIPTION	UOM	ORDER MULTIPLE
CVENT-2-EXT	2 in. Concentric Vent Kit, 60 in. Overall Ext. Length	EA	1
CVENT-3-EXT	3 in. Concentric Vent Kit, 60 in. Overall Ext. Length	EA	1

TANKLESS WATER HEATER CONNECTION KITS

EasyFlex Tankless Water Heater Connection Kits

The Tankless Water Heater Connection Kits by EASYFLEX are customized kits. Each kit includes one 1" OD, 3/4" MXF Gas Connector, two 3/4" ID, 3/4" FIP x 3/4" MIP Water Connectors, Hot & Cold Isolation Valve Set, and Pressure Relief Valve. One box has it all! Installation and maintenance are made easy for contractors and homeowners.



Global Pipe Manufacturer
EASYFLEX

CATALOG NO.	DESCRIPTION	UOM	ORDER MULTIPLE
EFLF-ISV-HCTP	Tankless Water Heater Isolation Valve Set	EA	1
EFHC-0118-3Y0118	Tankless Water Heater Isolation Valve Set + 18" Connectors	EA	1
EFHC-0124-3Y0124	Tankless Water Heater Isolation Valve Set + 24" Long Connectors	EA	1

DIVERSITECH GAS CONNECTORS

DiversiTech Gas Connectors 1/2" OD

Combining flexibility, durability, and functionality, DiversiTech stainless steel gas connectors are CSA design certified and 100% leak tested for quality and security. DiversiTech gas connectors are durable and reliable to give you everything you need. Available in a variety of sizes and lengths.



D20-3132-18

CATALOG NO.	DESCRIPTION	UOM	ORDER MULTIPLE
D20-3132-18	Gas Connector – 18" long, 1/2" OD x 3/8" ID, M x F	EA	12
D20-3132-24	Gas Connector – 24" long, 1/2" OD x 3/8" ID, M x F	EA	12
D20-3132-36	Gas Connector – 36" long, 1/2" OD x 3/8" ID, M x F	EA	12
D20-3132-48	Gas Connector – 48" long, 1/2" OD x 3/8" ID, M x F	EA	12

DiversiTech Gas Connectors 5/8" OD

Combining flexibility, durability, and functionality, DiversiTech stainless steel gas connectors are CSA design certified and 100% leak tested for quality and security. DiversiTech gas connectors are durable and reliable to give you everything you need. Available in a variety of sizes and lengths.



D30-3132-18

CATALOG NO.	DESCRIPTION	UOM	ORDER MULTIPLE
D30-3131-24	Gas Connector – 24" long, 5/8" OD x 1/2" ID, M x M	EA	12
D30-3131-36	Gas Connector – 36" long, 5/8" OD x 1/2" ID, M x M	EA	12
D30-3131-48	Gas Connector – 48" long, 5/8" OD x 1/2" ID, M x M	EA	12
D30-3132-18	Gas Connector – 18" long, 5/8" OD x 1/2" ID, M x F	EA	12
D30-3132-24	Gas Connector – 24" long, 5/8" OD x 1/2" ID, M x F	EA	12
D30-3132-36	Gas Connector – 36" long, 5/8" OD x 1/2" ID, M x F	EA	12
D30-3132-48	Gas Connector – 48" long, 5/8" OD x 1/2" ID, M x F	EA	12

Yellow Epoxy Coated Gas Connectors

Yellow coated gas connectors include an epoxy coating for added durability and extra protection from corrosion, chemical stains from common household products and plumbing repairs. They can be used in various applications: Dryers, Boilers, BBQ Grills, Ranges/Ovens, Furnaces, Fireplaces, Space Heaters, Tankless Water Heaters, Rooftop Units, Manufactured Homes.



DC30-3132-18

CATALOG NO.	DESCRIPTION	UOM	ORDER MULTIPLE
DC20-3132-18	Gas Connector coated – 18" long, 1/2" OD x 3/8" ID, M x F	EA	12
DC20-3132-24	Gas Connector coated – 24" long, 1/2" OD x 3/8" ID, M x F	EA	12
DC20-3132-36	Gas Connector coated – 36" long, 1/2" OD x 3/8" ID, M x F	EA	12
DC20-3132-48	Gas Connector coated – 48" long, 1/2" OD x 3/8" ID, M x F	EA	12
DC20-3131-18	Gas Connector coated – 18" long, 1/2" OD x 3/8" ID, M x F	EA	12
DC20-3131-24	Gas Connector coated – 24" long, 1/2" OD x 3/8" ID, M x F	EA	12
DC20-3131-36	Gas Connector coated – 36" long, 1/2" OD x 3/8" ID, M x F	EA	12
DC20-3131-48	Gas Connector coated – 48" long, 1/2" OD x 3/8" ID, M x F	EA	12
DC30-3132-18	Gas Connector coated – 18" long, 5/8" OD x 1/2" ID, M x F	EA	12
DC30-3132-24	Gas Connector coated – 24" long, 5/8" OD x 1/2" ID, M x F	EA	12
DC30-3132-36	Gas Connector coated – 36" long, 5/8" OD x 1/2" ID, M x F	EA	12
DC30-3132-48	Gas Connector coated – 48" long, 5/8" OD x 1/2" ID, M x F	EA	12
DC30-3131-18	Gas Connector coated – 18" long, 5/8" OD x 1/2" ID, M x M	EA	12
DC30-3131-24	Gas Connector coated – 24" long, 5/8" OD x 1/2" ID, M x M	EA	12
DC30-3131-36	Gas Connector coated – 36" long, 5/8" OD x 1/2" ID, M x M	EA	12
DC30-3131-48	Gas Connector coated – 48" long, 5/8" OD x 1/2" ID, M x M	EA	12

DORMONT GAS CONNECTORS AND VALVES

Dormont 20 Series

1/2" O.D. x 3/8" I.D. 1/2" MIP x 1/2" FIP Connectors



20-3132-18

CATALOG NO.	DESCRIPTION	UOM	ORDER MULTIPLE
20-3132-18	Gas Connector – 18" Long	EA	12
20-3132-24	Gas Connector – 24" Long	EA	12
20-3132-36	Gas Connector – 36" Long	EA	12
20-3132-48	Gas Connector – 48" Long	EA	12

Dormont 20 Series with Valve

Corrugated stainless steel connectors with special Supr Safe design to increase flexibility. Maximum service and safety and is approved for both indoor and outdoor use. This is perfect for range and furnace connections. This Series is AA and CGA approved. This connector comes in 20 3135 18 1/2" O.D. x 3/8" I.D. x 1/2" FIP Ball Valve.



20-3135-18

CATALOG NO.	DESCRIPTION	UOM	ORDER MULTIPLE
20-3135-18	Gas Connector – 18" Long	EA	12
20-3135-24	Gas Connector – 24" Long	EA	12
20-3135-36	Gas Connector – 36" Long	EA	12
20-3135-48	Gas Connector – 48" Long	EA	12

Dormont 30 Series

Corrugated, stainless steel connectors with special Supr Safe® design to increase flexibility. Maximum service and safety, approved for indoor or outdoor use. Perfect for range and furnace connection. AGA and CGA approved. 3131 Series: 5/8" O.D. x 1/2" I.D. 1/2" MIP x 1/2" MIP Connectors. 3132 Series: 5/8" O.D. x 1/2" I.D. 1/2" MIP x 1/2" FIP Connectors.



30-3132-18

CATALOG NO.	DESCRIPTION	UOM	ORDER MULTIPLE
30-3131-24	Gas Connector – 24" Long	EA	12
30-3131-36	Gas Connector – 36" Long	EA	12
30-3131-48	Gas Connector – 48" Long	EA	12
30-3132-12	Gas Connector – 12" Long	EA	12
30-3132-18	Gas Connector – 18" Long	EA	12
30-3132-24	Gas Connector – 24" Long	EA	12
30-3132-30	Gas Connector – 30" Long	EA	12
30-3132-36	Gas Connector – 36" Long	EA	12
30-3132-48	Gas Connector – 48" Long	EA	12
30-3132-60	Gas Connector – 60" Long	EA	12
30-3132-72	Gas Connector – 72" Long	EA	12

Gas Ball Valve

Gas Ball Valves meet the stringent ISO 9000 quality standard. AGA and CGA certified.



91-3042

CATALOG NO.	DESCRIPTION	UOM	ORDER MULTIPLE
91-3042	5/8" O.D. Flare x 3/4" FIP for "30 Series" Gas Conn.	EA	10
91-2032	1/2" O.D. Flare x 1/2" FIP for "20 Series" Gas Conn.	EA	10
92-3232	1/2" FIP x 1/2" FIP	EA	10
92-4242	3/4" FIP x 3/4" FIP	EA	10

CARBON MONOXIDE & SMOKE ALARMS

Carbon Monoxide Alarms

- 10 year sealed batteries provide continuous protection
- Microprocessor intelligence combined with electrochemical sensor virtually eliminates nuisance alarms
- Red LED indicates the status of power and CO
- Table top (free standing) or wall mounted. Mounting hardware included.
- Exceeds industry standards, ETL listed to UL Standard UL 2034 and California State Fire Marshal approved.
- 10 year limited warranty on both battery and alarm



CM-1000

CATALOG NO.	DESCRIPTION	UOM	ORDER MULTIPLE
CM-1000	Carbon Monoxide Smart Alarm	EA	1

loPhic® Smoke & Fire, Carbon Monoxide & Natural Gas Alarm

- 4-in-1 smart alarm uses a single sensor to detect both CO & Natural Gas AND protects against both fast flaming & slow smoldering fires
- 120-volt AC hardwired alarm with backup 9 volt battery is suitable for houses, apartments and mobile homes
- Mount the bracket to any standard wiring junction box and use the large mounting base to cover imperfections in drywall
- Features a quick activation pull-tab and a front-loading battery drawer for replacement without removing the alarm from the bracket
- Comes with a 7 year limited warranty



MDSCN111

CATALOG NO.	DESCRIPTION	UOM	ORDER MULTIPLE
MDSCN111	Smoke & Fire, Carbon Monoxide and Natural Gas Alarm	EA	4

BLACK STEEL WELDED NIPPLES

Black Steel Welded Nipples

Welded Steel that withstands 700 PSI test pressure is perfect for everyday use. The specs for this product are ASTM A 120 (Nom B 10) and the thickness is Sch. 40.



CATALOG NO.	DESCRIPTION	UOM	ORDER MULTIPLE
BPN-1	1/2" x CL Black Welded Nipple	EA	25
BPN-2	1/2" x 1-1/2" Black Welded Nipple	EA	25
BPN-3	1/2" x 2" Black Welded Nipple	EA	25
BPN-4	1/2" x 2-1/2" Black Welded Nipple	EA	25
BPN-5	1/2" x 3" Black Welded Nipple	EA	25
BPN-6	1/2" x 3-1/2" Black Welded Nipple	EA	25
BPN-7	1/2" x 4" Black Welded Nipple	EA	20
BPN-8	1/2" x 4-1/2" Black Welded Nipple	EA	15
BPN-9	1/2" x 5" Black Welded Nipple	EA	15
BPN-10	1/2" x 5-1/2" Black Welded Nipple	EA	25
BPN-11	1/2" x 6" Black Welded Nipple	EA	15
BPN-12	1/2" x 7" Black Welded Nipple	EA	25
BPN-13	1/2" x 8" Black Welded Nipple	EA	15
BPN-14	1/2" x 9" Black Welded Nipple	EA	25
BPN-15	1/2" x 10" Black Welded Nipple	EA	15
BPN-16	1/2" x 11" Black Welded Nipple	EA	25
BPN-17	1/2" x 12" Black Welded Nipple	EA	15
BPN-18	3/4" x CL Black Welded Nipple	EA	25
BPN-19	3/4" x 1-1/2" Black Welded Nipple	EA	25
BPN-20	3/4" x 2" Black Welded Nipple	EA	25
BPN-21	3/4" x 2-1/2" Black Welded Nipple	EA	25
BPN-22	3/4" x 3" Black Welded Nipple	EA	15
BPN-23	3/4" x 3-1/2" Black Welded Nipple	EA	15
BPN-24	3/4" x 4" Black Welded Nipple	EA	15
BPN-25	3/4" x 4-1/2" Black Welded Nipple	EA	20

Black Steel Welded Nipples (cont'd)

CATALOG NO.	DESCRIPTION	UOM	ORDER MULTIPLE
BPN-26	3/4" x 5" Black Welded Nipple	EA	20
BPN-28	3/4" x 6" Black Welded Nipple	EA	15
BPN-30	3/4" x 8" Black Welded Nipple	EA	10
BPN-32	3/4" x 10" Black Welded Nipple	EA	10
BPN-34	3/4" x 12" Black Welded Nipple	EA	15
BPN-35	1" x CL Black Welded Nipple	EA	25
BPN-37	1" x 2" Black Welded Nipple	EA	25
BPN-38	1" x 2-1/2" Black Welded Nipple	EA	25
BPN-39	1" x 3" Black Welded Nipple	EA	5
BPN-40	1" x 3-1/2" Black Welded Nipple	EA	5
BPN-41	1" x 4" Black Welded Nipple	EA	10
BPN-43	1" x 5" Black Welded Nipple	EA	5
BPN-44	1" x 5-1/2" Black Welded Nipple	EA	10
BPN-45	1" x 6" Black Welded Nipple	EA	5
BPN-47	1" x 8" Black Welded Nipple	EA	5
BPN-51	1" x 12" Black Welded Nipple	EA	5
BPN-52	1/2" x 18" Black Welded Nipple	EA	5
BPN-53	1/2" x 24" Black Welded Nipple	EA	3
BPN-54	1/2" x 36" Black Welded Nipple	EA	5
BPN-A12	1/2" Assortment Pack, 6 each of CL thru 6", pack of 66	PK	2
BPN-A34	3/4" Assortment Pack, 6 each of CL thru 6", pack of 66	PK	2

MALLEABLE BLACK IRON PIPE FITTINGS

90 Degree Ell

- Material: ASTM A 197 Cupola Malleable Iron, 150 lb.
- Dimensions:
 - ANSI B 16.3 - Malleable Iron Threaded Fittings
 - ANSI B 16.14 - Ferrous Pipe Plugs, Bushings etc.
 - ANSI B 16.39 - Malleable Iron Threaded Pipe Unions
- Threads: ANSI B 2.1 or BS 21
- Tensile Strength: 28.4 kg/mm.min



CATALOG NO.	DESCRIPTION	UOM	ORDER MULTIPLE
BPF-01	1/2" 90 Degree Elbow	EA	50
BPF-02	3/4" 90 Degree Elbow	EA	35
BPF-03	1" 90 Degree Elbow	EA	20

45 Degree Ell

The 45 Degree Ell fitting is made of ASTM A 197 Cupola Malleable Iron, 150 LB. The dimensions for this fitting are ANSI B 16.3. The threads are ANSI V 2.1 or BS 21 and the tensile strength is 28.4 kg/mm.min for this fitting.



CATALOG NO.	DESCRIPTION	UOM	ORDER MULTIPLE
BPF-04	1/2" 45 Degree Elbow	EA	50
BPF-05	3/4" 45 Degree Elbow	EA	40
BPF-06	1" 45 Degree Elbow	EA	15

Coupling

The Coupling fitting is made of ASTM A 197 Cupola Malleable Iron, 150 LB. The dimensions for this fitting are ANSI B 16.3. The threads are ANSI V 2.1 or BS 21 and the tensile strength is 28.4 kg/mm.min for this fitting.



CATALOG NO.	DESCRIPTION	UOM	ORDER MULTIPLE
BPF-07	1/2" Coupling	EA	60
BPF-08	3/4" Coupling	EA	50
BPF-09	1" Coupling	EA	25

Reducing Coupling

The Reducing Coupling fitting is made of ASTM A 197 Cupola Malleable Iron, 150 LB. The dimensions for this fitting are ANSI B 16.3. The threads are ANSI V 2.1 or BS 21 and the tensile strength is 28.4 kg/mm.min for this fitting.



CATALOG NO.	DESCRIPTION	UOM	ORDER MULTIPLE
BPF-10	3/4" x 1/2" Reducing Coupling	EA	60
BPF-11	1" x 1/2" Reducing Coupling	EA	30
BPF-12	1" x 3/4" Reducing Coupling	EA	25

90 Degree Street Ell

The 90 Degree Street Ell fitting is made of ASTM A 197 Cupola Malleable Iron, 150 LB. The dimensions for this fitting are ANSI B 16.3. The threads are ANSI V 2.1 or BS 21 and the tensile strength is 28.4 kg/mm.min for this fitting.



CATALOG NO.	DESCRIPTION	UOM	ORDER MULTIPLE
BPF-13	1/2" 90 Degree Street Elbow	EA	60
BPF-14	3/4" 90 Degree Street Elbow	EA	35

Tee

The Tee fitting is made of ASTM A 197 Cupola Malleable Iron, 150 LB. The dimensions for this fitting are ANSI B 16.3. The threads are ANSI V 2.1 or BS 21 and the tensile strength is 28.4 kg/mm.min for this fitting.



CATALOG NO.	DESCRIPTION	UOM	ORDER MULTIPLE
BPF-16	1/2" Tee	EA	40
BPF-17	3/4" Tee	EA	35
BPF-18	1" Tee	EA	20

Reducing Tee

The Reducing Tee fitting is made of ASTM A 197 Cupola Malleable Iron, 150 LB. The dimensions for this fitting are ANSI B 16.3. The threads are ANSI V 2.1 or BS 21 and the tensile strength is 28.4 kg/mm.min for this fitting.



CATALOG NO.	DESCRIPTION	UOM	ORDER MULTIPLE
BPF-20	3/4" x 1/2" x 1/2" Reducing Tee	EA	25
BPF-21	3/4" x 1/2" x 3/4" Reducing Tee	EA	20
BPF-34	1" x 1" x 1/2" Reducing Tee	EA	15

Bushing

The Bushing fitting is made of ASTM A 197 Cupola Malleable Iron, 150 LB. The dimensions for this fitting are ANSI B 16.14. The threads are ANSI V 2.1 or BS 21 and the tensile strength is 28.4 kg/mm.min for this fitting.



CATALOG NO.	DESCRIPTION	UOM	ORDER MULTIPLE
BPF-22	3/4" x 1/2" Hex Bushing	EA	75
BPF-23	1" x 1/2" Hex Bushing	EA	50

Cap

The Cap fitting is made of ASTM A 197 Cupola Malleable Iron, 150 LB. The dimensions for this fitting are ANSI B 16.3. The threads are ANSI V 2.1 or BS 21 and the tensile strength is 28.4 kg/mm.min for this fitting.



CATALOG NO.	DESCRIPTION	UOM	ORDER MULTIPLE
BPF-25	1/2" Cap	EA	75
BPF-26	3/4" Cap	EA	40
BPF-27	1" Cap	EA	35

Plug

The Plug fitting is made of ASTM A 197 Cupola Malleable Iron, 150 LB. The dimensions for this fitting are ANSI B 16.14. The threads are ANSI V 2.1 or BS 21 and the tensile strength is 28.4 kg/mm.min for this fitting.



CATALOG NO.	DESCRIPTION	UOM	ORDER MULTIPLE
BPF-28	1/2" Plug	EA	50
BPF-29	3/4" Plug	EA	30

Union

The Union fitting is made of ASTM A 197 Cupola Malleable Iron, 150 LB. The dimensions for this fitting are ANSI B 16.39. The threads are ANSI V 2.1 or BS 21 and the tensile strength is 28.4 kg/mm.min for this fitting.



CATALOG NO.	DESCRIPTION	UOM	ORDER MULTIPLE
BPF-31	1/2" Union	EA	50
BPF-32	3/4" Union	EA	35
BPF-33	1" Union	EA	20

TAPE

Yellow PTFE Thread Seal Tape

Oatey® Yellow Gas Line PTFE Thread Seal Tape is designed and manufactured for natural gas, propane, butane, water, oil and chemical lines. It is heavier than white tape with density of 1.35-1.50 grams/cubic centimeters, 4 mils thick. It complies with MIL-T-22230A (ASG), UL 31 RO, AGA 3226 and CAN/ULC-S642.



CATALOG NO.	DESCRIPTION	UOM	ORDER MULTIPLE
513-31403D	Yellow PTFE Thread Seal Tape, 1/2 in. x 260 in.	EA	1

CONDENSATE MANAGEMENT

ClearVue™ Tube & Traps.....	38
Condensate Drain Line Cleaning	39
Condensate Drain Line Switches	37-38
Condensate Drain Pans, Fittings, Adapters.....	40-41
Condensate Neutralizers.....	37
Condensate Pumps.....	36-37
Drain Line, Tubing	41-42
Tapes	42

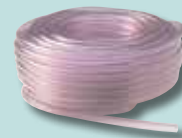

CONDENSATE PUMPS

ClearVue™ Pump

No Float, No Problems! ClearVue's Variable Speed and Lift and Floatless Sensor™ make this the most advanced condensate pump ever. This new pump can provide up to 22' of lift if needed. ClearVue™ runs at the minimum speed needed, saving wear on the pump. The pump selects the lowest effective speed, making it quieter than a regular pump. Its unique self cleaning feature senses problems and automatically enters a self cleaning mode using condensate water to fix the issue. The ClearVue™ pump features a clear bottom tank to easily check the water level. Other features include: stainless steel mounting tabs, silicone rubber feet, reversible deck, four inlet holes, and LED indicator lights. ETL Listed File Number 3190890



CATALOG NO.	DESCRIPTION	UOM	ORDER MULTIPLE
IQP-120	ClearVue™ Pump – 120V – 0-22' Lift	EA	6
IQP-120T	ClearVue™ Pump w/Tube – 120V – 0-22' Lift	EA	6

FP-22 Furnace Pump

The FP-22 Furnace Pump is a full featured condensate pump designed for condensing furnaces and other hot water applications. It handles hot condensate water up to 190 degrees F. Other features include 22' lift, built-in P traps, steam resistant electronics, and a super tough tank. Available in 120 and 230V models.



CATALOG NO.	DESCRIPTION	UOM	ORDER MULTIPLE
FP-22	Furnace Pump 120V 22' Lift 190°F Condensate	EA	1
FP-22-230	Furnace Pump 230V 22' Lift 190°F Condensate	EA	1

BP-46 Boiler Pump

The BP-46 Boiler Pump is a heavy duty, full featured condensate pump for hot water applications up to 212 degrees F. It features a 46' lift, oil resistant tank and impeller, two inlet holes and 1/4 turn check valve. Additional features include high impact construction, large tank and is available in 120 and 230V models.



CATALOG NO.	DESCRIPTION	UOM	ORDER MULTIPLE
BP-46	High Temperature Boiler Pump 115V, 46' Lift 212°F Condensate	EA	1
BP-46-230	High Temperature Boiler Pump 230V, 46' Lift 212°F Condensate	EA	1

ClearVue™ Mini Ductless System Pump

Featuring super quiet operation, specifically designed for ductless system installations, and including Variable Speed and Lift and Floatless Sensor™. ClearVue™ Mini provides up to 35 feet of lift. ClearVue™ Mini is chock full of innovative features, and priced competitively.



CATALOG NO.	DESCRIPTION	UOM	ORDER MULTIPLE
CVMINI	ClearVue Mini - Ductless System Pump	EA	6

CP-22 Pumps

Suitable for use with condensate from HVAC equipment which produce condensate. 22' of lift compared to the typical 20'. Features include vibration dampening feet and motor mounts, metal hang tabs, four inlet holes, LED indicator lights showing pump status, a clear indicator display, a float switch and check valve. Integrating the CP-22 into your system is easy. 1/4" quick connect terminals provide easy connection to the built in overflow switch. 2 terminals are provided allowing flexibility to connect air handler shut down. UL Listed File Numbers E253155 and E258186.



CATALOG NO.	DESCRIPTION	UOM	ORDER MULTIPLE
CP-22	Condensate Pump – 120V	EA	6
CP-22T	Condensate Pump – 120V w/20' 3/8" Tube	EA	6
CP-22-230	Condensate Pump – 230V	EA	6
CP-22-230T	Condensate Pump – 230V w/20' 3/8" Tube	EA	6

CP-22 Low Profile Pumps

The new CP-22LP comes packed with all the same great features found in the CP-22, but now in a low profile package. This pump is only 4-3/8" tall so it's a good fit for those instances where space is at a premium. The shorter reservoir holds 1/3 gallon. Suitable for use with condensate up to 160 degree F. UL Listed File Numbers E253155 and E258186.



CATALOG NO.	DESCRIPTION	UOM	ORDER MULTIPLE
CP-22LP	Condensate Pump – 120V – Low Profile	EA	6
CP-22LP-230	Condensate Pump – 230V – Low Profile	EA	6

Plenum-Rated Low-Profile CP-22 Pump

The new plenum-rated low profile CP-22 pump provides more solutions for wholesalers and contractors when pumps for plenum-rated spaces are needed. Available in two voltages (120V and 230V) and designed with a flexible conduit holder. UL Listed File Numbers E253155 and E258186.



CATALOG NO.	DESCRIPTION	UOM	ORDER MULTIPLE
CP-22LP-P	Plenum-Rated Condensate Pump – 120V – Low Profile	EA	6
CP-22LP-230-P	Plenum-Rated Condensate Pump – 230V – Low Profile	EA	6

General Purpose Pumps

The DiversiTech CP-16 condensate pump is an economical alternative that's based off of the proven CP-22 design. More compact than the CP-22, it's designed to lift to a maximum of 16 feet. The CP-16 shares many of the great features of the CP-22, including hang tabs, four inlet holes, float switch, overflow switch, and a check valve. UL Listed File Numbers E253155 and E258186.



CATALOG NO.	DESCRIPTION	UOM	ORDER MULTIPLE
CP-16	Condensate Pump 16' Lift 120V	EA	6
CP-16-230	Condensate Pump 16' Lift 230V	EA	6

CONDENSATE PUMPS cont'd

Mini-Split Pumps

DiversiTech's Mini-Split Condensate Pump is a quiet, super compact, and feature rich pump that fits almost anywhere. Compatible with all brands of mini-split units. Provides 24' of lift with 6' suction lift. Pump fits easily in most line set covers and includes all needed accessories. Available in 115V and 230V versions.



CATALOG NO.	DESCRIPTION	UOM	ORDER MULTIPLE
CP-M115	Mini-Split Condensate Pump, 115V	EA	10
CP-M230	Mini-Split Condensate Pump, 230V	EA	10

Pump Parts & Accessories

Check valve installs easily and prevents water from travelling backwards into the pump and overflowing.



CATALOG NO.	DESCRIPTION	UOM	ORDER MULTIPLE
CP-CV	Replacement Check Valve for CP-22	EA	1

CONDENSATE NEUTRALIZERS

Condensate Neutralizers

DiversiTech offers a full line of condensate neutralizing products including both vertical (wall) and horizontal (floor) mounted units and pumps ideal for any installation. These products raise the pH of acidic condensate to prevent damage to drains or equipment and help protect the environment. Replacement media also available for all neutralizer units.

CATALOG NO.	DESCRIPTION	UOM	ORDER MULTIPLE
CNV-4K	Vertically Mounted for up to 400K BTU systems	EA	1
CNH-4K	Horizontally Mounted for up to 400K BTU systems	EA	1
CNHK-4K	Horizontally Mounted Kit w/PVC union fittings for up to 400K BTU systems	EA	1
CNT-3M	Low profile 3.5 gallon tank for up to 3 million BTU systems	EA	1
CNM-3M	Replacement Neutralizing Media for CNT-3M tank	EA	1
CNM-4K	Replacement Neutralizing Media for CNV-4K and CNH-4K	EA	1
CNM-BULK	Replacement Neutralizing Bulk Media, 35 lbs.	EA	1
FP-22-CN5K	22 ft. Lift Harsh Environment Condensate Pump with built in neutralization tank (up to 500K BTU)	EA	1
CNM-5K	Replacement Neutralizing Bulk Media for FP-22-CN5K	EA	1



CONDENSATE DRAIN LINE SWITCHES

PAN MOUNTED SWITCHES

Wet Switch® Flood Detector

A solid state control designed to help prevent flooding, damage to carpets, walls, furniture, ceilings, etc. Has a built-in test and reset button for easier installation. Turns system off when detecting moisture due to condensate or drain leaks. One or two drops will cause Wet Switch® to turn off a unit, alerting a serviceman to a moisture problem. A lit LED indicates the Wet Switch® is activated and has turned the unit off. Reset simply by drying the absorbent pad with a paper towel and pressing the reset switch. Connects to 24 VAC. More than one unit may be connected to a system. 2 amp contact rating. Simple 5 wire installation. Sales displays available. ETL Listed File Number 3146992. UL508 Approved.



CATALOG NO.	DESCRIPTION	UOM	ORDER MULTIPLE
WS-1	Wet Switch® Flood Detector	EA	1

CS1200 AC Shutoff Switch

The CS1200 is a fast installing, reliable, condensate overflow detection pan switch. Featuring a unique universal pan mount design to assure accurate detection in metal or plastic secondary drain pans. UL508 Approved.



CATALOG NO.	DESCRIPTION	UOM	ORDER MULTIPLE
CS1200	CS1200 AC Shutoff Switch	EA	12

Condensate Cop™

Condensate Cop™ is a unique clamp on float switch intended for HVAC drain pan installation. The Condensate Cop™ features a large over clamping area that fits easily over the edge of all types of drain pans; including formed plastic and galvanized sheet metal. A separate float/probe assembly swivels to accommodate drain pans having sloped sides. The swivel action allows the installer to position the float switch for best operation and then clamp it into place. The probe features an inlet grill which prevents the float from being blocked or damaged by insulation or other debris. Sealed inside the probe is a magnetically actuated normally closed switch. The switch opens when rising water presents a potential flooding condition. Two wire connection for easy hook up to a thermostat "Y" (compressor) circuit. Provided complete with 5' (1.5 meter) leads, wire nuts, and clamping screws. Small size, 24V/1.5 amp NC reed switch. ETL Listed File Number 3166285. UL508 Approved.



CATALOG NO.	DESCRIPTION	UOM	ORDER MULTIPLE
CC-1	Condensate Cop™ Drain Pan Switch	EA	12

CS-3 Condensate Pan Switch

The CS-3 is a clip-on pan switch that use a magnetic reed switch for condensate overflow protection.



CATALOG NO.	DESCRIPTION	UOM	ORDER MULTIPLE
CS-3	Condensate Switch – Clip	EA	12
CS-3-BULK50	Condensate Switch - Clip, Bulk Pack	EA	50

CONDENSATE DRAIN LINE SWITCHES cont'd

Plenum-Rated Condensate Switches

DiversiTech plenum-rated condensate overflow prevention switches for primary or auxiliary lines are small, simple to install and easy to service reed switch technology. Both are signed designed with a pull-to-test lever to validate installation. As water level in the auxiliary or main drain pipe rises due to a clogged condensate drain line, the switch shuts off the system - thus preventing water from overflowing and causing damage to doors, walls and ceilings. A red LED illuminating light notifies a homeowner/service technician that the switch has triggered. At the heart of the switch is a durable yet precise magnetic reed switch. Constructed of materials that will not rust or stick, both switches are plenum rated, conforming to UL2043 and are UL508 approved.

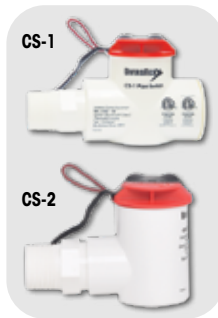

CATALOG NO.	DESCRIPTION	UOM	ORDER MULTIPLE
CS-1	Plenum-Rated Condensate Switch - Tee	EA	12
CS-1-BULK50	Plenum-Rated Condensate Switch - Tee, Bulk Pack	EA	50
CS-2	Plenum-Rated Condensate Switch - Elbow	EA	12
CS-2-BULK50	Plenum-Rated Condensate Switch - Elbow, Bulk Pack	EA	50

Universal Alarm

A universal low voltage alarm that can indicate possible system trouble. Use with the Wet Switch®, SOS, Condensate Cop, CP 22 (all types) and all float switches on 24VAC control circuits. If an alarm condition exists, the homeowner can turn the alarm off with a "silence" button until service is obtained, however a red trouble LED will remain lit. Also features: easy 2 wire connection, label to print contractor information, and low current draw. Actuates at greater than 18V to prevent any false alarms due to low voltage. Includes 2 wire nuts, a sheet metal screw, and double sided tape for convenient installation options. Also includes instructions for wiring normally open switch systems (for the CP 22 or other condensate pumps).



CATALOG NO.	DESCRIPTION	UOM	ORDER MULTIPLE
UA-1	Universal Alarm for 24VAC	EA	12

CLEARVUE™ TUBE & TRAPS

ClearVue™ Tube

Clear, 3/4" schedule 40 PVC ideal for installing as condensate drain lines in other areas where seeing the inside of the tubing is helpful. ClearVue™ Tube makes it easy to quickly spot build up or obstructions in drain lines for faster troubleshooting. Available in 5ft lengths.



CATALOG NO.	DESCRIPTION	UOM	ORDER MULTIPLE
CV-TUBE	ClearVue™ Tube – 5' section	EA	50

Drain Trap Kits

Drain trap kits feature clear PVC traps with multiple cleanouts for easy maintenance. Available in several fitting styles with or without float switch to match any installation need.



CATALOG NO.	DESCRIPTION	UOM	ORDER MULTIPLE
DTK113	Drain Trap Kit, 3/4 in Blow Molded	EA	1
DTK113B	Drain Trap Kit, 3/4 in, w/Brush	EA	1
DTK205	Drain Trap Kit, 3/4 in, Deep w/switch	EA	1
DTK207	Drain Trap Kit, 3/4 in, Standard w/switch and cross	EA	1
DTK210	Drain Trap Kit, 3/4 in, Standard w/switch	EA	1

ClearVue™ Traps

DiversiTech introduces new ClearVue™ P and R traps. These traps are made from smooth, clear PVC with no flat spots to restrict flow. With these new ClearVue™ traps its easy to see directly into them to detect blockages and prevent problems before they become severe. Ideal for installation in condensate drain lines.

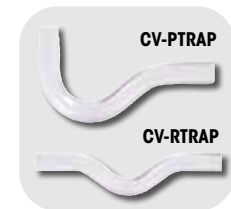

CATALOG NO.	DESCRIPTION	UOM	ORDER MULTIPLE
CV-PTRAP	ClearVue™ 3/4" P trap	EA	25
CV-RTRAP	ClearVue™ 3/4" R trap	EA	25
CV-UTRAP	ClearVue™ 3/4" U trap	EA	25

Drain Trap Kit Cross Reference

DIVERSITECH CATALOG NO.	RECTORSEAL PART NO.
DTK113	EZT-113
DTK113B	EZT-113B
DTK205	EZT-205
DTK207	EZT-207
DTK210	EZT-210

CONDENSATE DRAIN LINE CLEANING

DrainGun™ - 16g SWOOSH® CO₂ Cartridges

Clears condensate drains with a SWOOSH! A lightweight (3 oz.) portable tool designed to blow out drain lines instantly. New larger SWOOSH® CO₂ cartridges now deliver 800 PSI of oil free air to clear the line. Each unit comes equipped with a tapered fitting to work on 3/8 in. - 3/4 in. drain openings. Flexible hose assembly maneuvers through cabinets, coils and hard to reach drains. Cartridges are environmentally safe and recyclable. No need for air or nitrogen tanks. Reduces labor costs and time on service calls.



GG-1



GG-1A

CATALOG NO.	DESCRIPTION	UOM	ORDER MULTIPLE
GG-1	DrainGun™ for A/C Condensate Lines	EA	6
GGC-12	SWOOSH® 16g CO ₂ Cartridges, pack of 12	PK	1
GG-1A	DrainGun™ Adapter Kit	EA	1
GG-1H	DrainGun™ Hose Assembly	EA	1
GG-1TF	DrainGun™ replacement tip	EA	1
GG-1BOR	DrainGun™ bottom o-ring, pack of 5	PK	1

SWOOSH® DRAIN GUN BIG SHOT™ - 20g SWOOSH® CO₂ Cartridges

The SWOOSH® DRAIN GUN BIG SHOT™ is the newest drain clearing tool from DiversiTech. The SWOOSH® DRAIN GUN BIG SHOT™ uses new larger 20 gram SWOOSH® cartridges that provide 25% more capacity to better remove clogs, gunk and debris from drain lines. And the SWOOSH® DRAIN GUN BIG SHOT™ includes a flexible hose with tapered fitting to easily connect with drain line opening for fast and easy clearing.



SG-1



SGC-12

CATALOG NO.	DESCRIPTION	UOM	ORDER MULTIPLE
SG-1	SWOOSH® DRAIN GUN BIG SHOT™	EA	6
SGC-12	SWOOSH® 20g CO ₂ Cartridges, pack of 12	PK	1

DrainDawg™ and DrainKat™ Fittings

The DrainDawg™ and DrainKat™ products are compatible with a series of fittings to connect to condensate drain lines and hoses. The fittings are available individually, or as kits for the DrainDawg™ and DrainKat™.

CATALOG NO.	DESCRIPTION	UOM	ORDER MULTIPLE
AP-DD	DrainDawg™ Accessory Pack	EA	1
AP-DK	DrainKat™ Accessory Pack	EA	1
BS-25	Blow gun with safety tip for DrainDawg™ or DrainKat™	EA	1
CB-03	3/4 in. cone tip with female thread for DrainDawg™ or DrainKat™ blow gun	EA	1
CK-141	3/4 in. cone with male thread for use with whip hose for DrainDawg™ or DrainKat™	EA	1
CW-15	15 in. whip hose for DrainDawg™ or DrainKat™	EA	1
DF-75	DrainDawg™ inflatable tip for drain line blowout	EA	1
FA-01	Nitrogen to CO ₂ adapter, male by male for DrainKat™	EA	1
FA-02	Nitrogen to CO ₂ adapter, female by female for DrainDawg™	EA	1
FA-03	CO ₂ transfill adapter for DrainKat™	EA	1
QN-S3	Needle tip with female thread for DrainDawg™ or DrainKat™ blow gun	EA	1
TC-25	Tire chuck for DrainDawg™	EA	1
TG-10	120 in. blow gun hose for DrainDawg™	EA	1
TG-87A	87 in. blow gun hose for DrainKat™	EA	1

DrainDawg™

The DrainDawg™ is a complete condensate drain cleaning kit, including the CT-475M deluxe nitrogen / CO₂ 0-475 psi regulator, the TG-10 & BS-25 ten foot hose and blowgun assembly, and the CW-15 fifteen inch whip hose. Also included is the AP-DD DrainDawg™ Accessory Fitting Kit which contains the DF-75 DrainDawg™ inflatable tip, the CK-141 3/4"-1" cone fitting, the FA-02 CO₂ to nitrogen adapter, the QN-S3 needle tip, and the TC-25 tire chuck. Made in USA.



CB-2

CATALOG NO.	DESCRIPTION	UOM	ORDER MULTIPLE
CB-2	DrainDawg™ Kit	EA	3

DrainKat™

The DrainKat™ is an over the shoulder refillable, nitrogen or CO₂ mini drain cleaning kit. Featuring a small cylinder that holds 9 cubic feet of nitrogen or 2-1/2 pounds of CO₂. The cylinder includes an integral mounted regulator for quick and easy adjustment of discharge pressure. Get exactly the amount of pressure you need with a quick adjustment on the regulator. Furnished complete with an 87" hose and drain gun kit, the CW-15 whip hose, and the AP-DK DrainKat™ Accessory Fitting Kit which contains the DF-75 DrainDawg™ inflatable tip, the CB-03 3/4"-1" cone fitting, the FA-01 male to male CO₂ to nitrogen adapter, the FA-03 CO₂ trans-fill adapter, and the the QN-S3 needle tip. Made in the USA.



MBK-6

CATALOG NO.	DESCRIPTION	UOM	ORDER MULTIPLE
MBK-6	DrainKat™ Kit	EA	2

A/C Easy Tee®

A/C Easy Tee® is a simple, inexpensive way to comply with the International Mechanical Code M32-12. It provides a Condensate Drain Service Port that is flexible and easy to use with nitrogen, water, or shop vac. A/C Easy Tee® has no valve or moving parts that could fail.



ET75

CATALOG NO.	DESCRIPTION	UOM	ORDER MULTIPLE
ET75	A/C Easy Tee®	EA	20
ET75-KIT	A/C Easy Tee® Kit - 2 Tees and ST75	EA	6
ST75	Service Tool Kit	EA	6



DF-75

CONDENSATE DRAIN PANS, FITTINGS, ADAPTERS

A/C Secondary Condensate Drain Pans

Rolled edges for durability, ribbed bottoms for rigidity, and reinforced corners for strength. 3/4 in. PVC fittings are included with each pan. No seams, no rust, and no leakage. ABS materials will not put out toxic smoke. Available in over 20 convenient sizes. Five pans per clip.

CATALOG NO.	BOTTOM DIMENSION		OVERALL DIMENSION		DEPTH		UOM	ORDER MULTIPLE
	IN.	CM.	IN.	CM.	IN.	CM.		
6-1838L	18" x 38"	46 x 97	20" x 40"	51 x 102	2"	5	EA	5
6-1838S	18" x 38"	46 x 97	20" x 40"	51 x 102	2"	5	EA	5
6-2424L	24" x 24"	61 x 61	26" x 26"	66 x 66	2"	5	EA	5
6-2626L	26" x 26"	66 x 66	28" x 28"	71 x 71	2"	5	EA	5
6-2739L	27" x 39"	69 x 99	29" x 41"	74 x 104	2"	5	EA	5
6-2748L	27" x 48"	69 x 122	29" x 50"	74 x 127	2"	5	EA	5
6-2763L	27" x 63"	69 x 160	29" x 65"	74 x 165	2"	5	EA	5
6-3030L	30" x 30"	76 x 76	32" x 32"	81 x 81	2"	5	EA	5
6-3050L	30" x 50"	76 x 127	32" x 52"	81 x 132	2"	5	EA	5
6-3060L	30" x 60"	76 x 152	32" x 62"	81 x 157	2"	5	EA	5
6-3060S	30" x 60"	76 x 152	32" x 62"	81 x 157	2"	5	EA	5
6-3263L	32" x 63"	81 x 160	34" x 65"	86 x 165	2"	5	EA	5
6-3660L	36" x 60"	91 x 152	38" x 62"	97 x 157	2"	5	EA	5
6-3660S	36" x 60"	91 x 152	38" x 62"	97 x 157	2"	5	EA	5

L = Drain Line Outlets in Long Side S = Drain Line Outlets in Short Side



6-1838L

High Rise Pans™

The High Rise Pan™ is an innovative new plastic drain pan design which allows placement of an air handler 2 3/4in. above the outside lip of the pan without the need for separate, cumbersome mounting blocks. The pan has a molded in network of risers to give a 5in. lift. The risers are positioned to accept a wide variety of air handler sizes. Each riser has a specially shaped area at each end to accommodate a 2in. x 2in. anti vibration pad which allows for quiet operation at all times. Other features include heavy duty reinforcement throughout to give plenty of support as well as rolled edges for durability. One piece plastic construction ensures no rust, leaks, or seams to split. Each High Rise Pan™ comes complete with a Condensate Cop™ float switch, 6 EVA™ anti vibration pads, and 1 3/4in. PVC male adapter. Installation is straightforward and hassle free.

CATALOG NO.	DESCRIPTION	UOM	ORDER MULTIPLE
6-HK2748	High Rise Pan™ 27" x 48" with Installation Kit including: One CC-1 Condensate Cop, Six MP-2E 2" x 2" EVA™ Pads, One 6-1 3/4" PVC male adapter	EA	5
6-HK2748-1	Single Pack Kit – High Rise Pan™ 27" x 48" with Installation Kit including: One CC-1 Condensate Cop, Six MP-2E 2" x 2" EVA™ Pads, One 6-1 3/4" PVC male adapter	EA	1
6-HK2766	High Rise Pan™ 27" x 66" with Installation Kit including: One CC-1 Condensate Cop, Six MP-2E 2" x 2" EVA™ Pads, One 6-1 3/4" PVC male adapter	EA	5
6-HK2766-1	Single Pack Kit – High Rise Pan™ 27" x 66" with Installation Kit including: One CC-1 Condensate Cop, Six MP-2E 2" x 2" EVA™ Pads, One 6-1 3/4" PVC male adapter	EA	1
6-HK3050	High Rise Pan™ 30" x 50" with Installation Kit including: One CC-1 Condensate Cop, Six MP-2E 2" x 2" EVA™ Pads, One 6-1 3/4" PVC male adapter	EA	5
6-HK3050-1	Single Pack Kit – High Rise Pan™ 30" x 50" with Installation Kit including: One CC-1 Condensate Cop, Six MP-2E 2" x 2" EVA™ Pads, One 6-1 3/4" PVC male adapter	EA	1
6-HK3060	High Rise Pan™ 30" x 60" with Installation Kit including: One CC-1 Condensate Cop, Six MP-2E 2" x 2" EVA™ Pads, One 6-1 3/4" PVC male adapter	EA	5
6-HK3060-1	Single Pack Kit – High Rise Pan™ 30" x 60" with Installation Kit including: One CC-1 Condensate Cop, Six MP-2E 2" x 2" EVA™ Pads, One 6-1 3/4" PVC male adapter	EA	1



6-HK2748



Heavy Duty High Rise Pans

A thicker, tougher version of our regular High Rise Pans. Each pan includes a kit with one CS1200 float switch, six EVA™ anti-vibration pads and one 3/4" PVC male adapter.



6-HK3060HD

CATALOG NO.	DESCRIPTION	UOM	ORDER MULTIPLE
6-HK3050HD	Heavy Duty High Rise Pan 30" x 50"	EA	5
6-HK3060HD	Heavy Duty High Rise Pan 30" x 60"	EA	5
6-HK3070HD	Heavy Duty High Rise Pan 30" x 70"	EA	5

Furnace Pans

DiversiTech furnace pans are designed specifically for furnace installations. Their one piece construction provides strength and durability for any furnace installation.



6-HK3378FUR

CATALOG NO.	DESCRIPTION	UOM	ORDER MULTIPLE
6-HK3364FUR	Furnace Pan – 33" x 64" with installation kit	EA	
6-HK3378FUR	Furnace Pan – 33" x 78" with installation kit	EA	

CONDENSATE DRAIN PANS, FITTINGS, ADAPTERS cont'd

Metal Drain Pan

The ultimate in drain pan design — tailored for easy distribution and installation. Full of features to make life easier on both the distributor and the contractor. Seamless, one piece metal construction with rolled edges on all sides for maximum safety and integrity. Nestable as well — a stack of 70 pans is only a foot high! Once on site, you'll never have to return to the distributor for missing parts. The fittings are packaged with the pan for simple and efficient installation. Choose between two possible drain outlet positions and install with confidence.

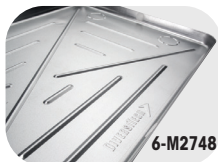

CATALOG NO.	DESCRIPTION	UOM	ORDER MULTIPLE
6-M2748	26 Gauge Metal Drain Pan – 27" x 48"	EA	5
6-M2763	26 Gauge Metal Drain Pan – 27" x 63"	EA	5
6-M3030	26 Gauge Metal Drain Pan – 30" x 30"	EA	5
6-M3050	26 Gauge Metal Drain Pan – 30" x 50"	EA	5
6-M3060	26 Gauge Metal Drain Pan – 30" x 60"	EA	5
6-M3263	26 Gauge Metal Drain Pan – 32" x 63"	EA	5

Mini-Split Drain Adapters

Mini Split fan units — either ceiling cassettes or wall cassettes — typically have a unique (metric) drain line fitting. DiversiTech's adapters convert this metric fitting to standard drain line tubing sizes.



CATALOG NO.	DESCRIPTION	UOM	ORDER MULTIPLE
230-DLFY	Mini-Split Drain Line Y	EA	1
230-DLF16	16mm Mini-Split Drain Line Adapter	EA	1
230-DLF18	18mm Mini-Split Drain Line Adapter	EA	1
230-DLF20	20mm Mini-Split Drain Line Adapter	EA	1
230-DLF25	25mm Mini-Split Drain Line Adapter	EA	1
230-DLF32	32mm Mini-Split Drain Line Adapter	EA	1

A/C Condensate Drain Pan Fittings

The Drain Pan Fittings are designed to be used with our Condensate Drain Pans.



CATALOG NO.	DESCRIPTION	UOM	ORDER MULTIPLE
6-1	3/4" Slip	EA	50
6-2	1" Slip	EA	50
6-3	3/4" Slip with Plastic Nut	EA	50
6-5	3/4" Female Pipe Thread	EA	50

Water Heater Pans

Aluminum water heater pans can be installed under gas or electric water heaters to protect from water damage. Includes a 1" PVC drain fittings to allow for connection to indirect drain. Each pan is manufactured from .032 in. prime aluminum with a pre-cut side opening to accommodate a drain fitting. Pan depth is a minimum 2.5 in.



CATALOG NO.	DESCRIPTION	UOM	ORDER MULTIPLE
6-M22	Aluminum Water Heater Pan - 22 in.	EA	6
6-M24	Aluminum Water Heater Pan - 24 in.	EA	6
6-M26	Aluminum Water Heater Pan - 26 in.	EA	6
6-M30	Aluminum Water Heater Pan - 30 in.	EA	6

Condensate Drain Pans

When a mini split system operates in heat pump mode, the outdoor coil becomes the evaporator coil. Typically, condensation generates from the evaporator coil. In certain installations, the condenser coil may be mounted overhead on brackets affixed to a wall. In these overhead applications, dripping condensation may be a nuisance. Condensate drain pans bolt onto the condenser mounting brackets, and the drain line can be plumbed to a nearby drain location. Furnished complete with all mounting hardware and drain pan outlet, condensate drain pans are available in either plastic or powder coated steel.

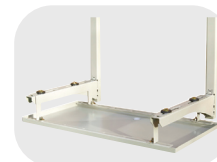
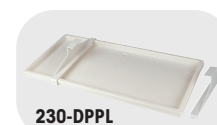

CATALOG NO.	DESCRIPTION	UOM	ORDER MULTIPLE
230-DPPL	Poly Condensate Drain Pan (Large)	EA	1
230-DPPM	Poly Condensate Drain Pan (Medium)	EA	1

DRAIN LINE, TUBING

Mini-Split Condensate Drain Line

A unique drain line for mini-split units. This large diameter drain line is typical for mini-split installations. Furnished in 160 feet lengths with cut marks every 3.28 feet. Accommodates 5/8" and 3/4" connections.



CATALOG NO.	DESCRIPTION	UOM	ORDER MULTIPLE
230-DL16	5/8" ID Mini-Split Drain Line	EA	160'
230-DL16-20	5/8" ID Mini-Split Drain Line – 20' section	EA	1

Clear Vinyl Tubing

Clear vinyl hose applications include: air conditioning and refrigeration condensate drains, condensate pump discharge lines and humidifier overflows.



CATALOG NO.	DESCRIPTION	UOM	ORDER MULTIPLE
7-316	3/16" ID Clear Vinyl Tubing – 100' section	EA	100'
7-CVMINITUBE	3/16" ID CVMINI Tubing – 100' section	EA	100'
7-14	1/4" ID Clear Vinyl Tubing – 100' section	EA	100'
7-38	3/8" ID Clear Vinyl Tubing – 100' section	EA	100'
7-12	1/2" ID Clear Vinyl Tubing – 100' section	EA	100'
7-58	5/8" ID Clear Vinyl Tubing – 100' section	EA	100'
7-34	3/4" ID Clear Vinyl Tubing – 100' section	EA	100'
7-78	7/8" ID Clear Vinyl Tubing – 50' section	EA	50'
7-10	1" ID Clear Vinyl Tubing – 50' section	EA	50'

DRAIN LINE, TUBING cont'd

Gorilla Tube® Clear Vinyl Tubing

Applications include: air conditioning and refrigeration condensate drains, condensate pump discharge lines, and humidifier overflows. Several sizes from 1/4" to 1" diameter. Non-toxic clear vinyl chloride.

Select Gorilla Tube® over standard clear vinyl tube because:

- Extra rigid design resists crimping and kinking due to durometer value of 80 (Shore A) and thicker wall
- Maximum service temperature 140°F (60°C)
- Better performance in cold weather climates.



7-14P

CATALOG NO.	DESCRIPTION	UOM	ORDER MULTIPLE
7-14P	1/4", .250" I.D., .360" O.D., .055 wall thickness	EA	100'
7-38P	3/8", .375" I.D., .495" O.D., .060 wall thickness	EA	100'
7-12P	1/2", .500" I.D., .631" O.D., .066 wall thickness	EA	100'
7-58P	5/8", .625" I.D., .771" O.D., .073 wall thickness	EA	100'
7-34P	3/4", .750" I.D., .913" O.D., .082 wall thickness	EA	100'
7-78P	7/8", .875" I.D., 1.050" O.D., .088 wall thickness	EA	50'
7-10P	1", 1.000" I.D., 1.215" O.D., .108 wall thickness	EA	50'

Braided Clear Vinyl Tubing

Braided clear vinyl offers better strength and sealing than regular clear vinyl tubing and is very kink-resistant.



7-14B

CATALOG NO.	DESCRIPTION	UOM	ORDER MULTIPLE
7-14B	1/4" ID Braided Clear Vinyl Tubing – 100' section	EA	100'
7-14B50	1/4" ID Braided Clear Vinyl Tubing – 50' section	EA	50'
7-38B	3/8" ID Braided Clear Vinyl Tubing – 100' section	EA	100'
7-38B50	3/8" ID Braided Clear Vinyl Tubing – 50' section	EA	50'
7-12B	1/2" ID Braided Clear Vinyl Tubing – 100' section	EA	100'
7-12B50	1/2" ID Braided Clear Vinyl Tubing – 50' section	EA	50'
7-58B	5/8" ID Braided Clear Vinyl Tubing – 100' section	EA	100'
7-58B50	5/8" ID Braided Clear Vinyl Tubing – 50' section	EA	50'
7-34B	3/4" ID Braided Clear Vinyl Tubing – 100' section	EA	100'
7-34B50	3/4" ID Braided Clear Vinyl Tubing – 50' section	EA	50'

TAPES

Cork Insulation Tape

Adheres firmly to all metals. Use on hot or cold pipes to stop condensation and drips.



6-330

CATALOG NO.	DESCRIPTION	UOM	ORDER MULTIPLE
6-330	Cork Insulation Tape – 1/8" x 2" x 30' Roll – Black	EA	12

PTFE Tape

Made of pure white PTFE. Non toxic. For use with chemicals, solvents, oxygen, and on food lines. Withstands up to 2000 psi of pressure.



6-733

CATALOG NO.	DESCRIPTION	UOM	ORDER MULTIPLE
6-733	Teflon Tape – 1/2" x 520"	EA	100
6-734	Teflon Tape – 1/2" x 260"	EA	100
6-735	Teflon Tape – 3/4" x 520"	EA	100
6-736	Teflon Tape – 3/4" x 260"	EA	100

Foam Insulation Tape

Superior self-adhesive foam tape can be used on hot or cold pipes. Fits well around valves and fittings. Easily cut and molded.



6-9718

CATALOG NO.	DESCRIPTION	UOM	ORDER MULTIPLE
6-9718	Foam Insulation Tape – 1/8" x 2" x 30' Roll – Black	EA	12

Yellow PTFE Thread Seal Tape

Oatey® Yellow Gas Line PTFE Thread Seal Tape is designed and manufactured for natural gas, propane, butane, water, oil and chemical lines. It is heavier than white tape with density of 1.35 - 1.50 grams/cubic centimeters, 4 mils thick. It complies with MIL-T-22230A (ASG), UL 31 RO, AGA 3226 and CAN/ULC-S642.



513-31403D

CATALOG NO.	DESCRIPTION	UOM	ORDER MULTIPLE
513-31403D	Yellow PTFE Thread Seal Tape, 1/2 in. x 260 in.	EA	100

GENERAL INDUSTRIAL

Abrasive Cloths.....	44
Aerosols.....	44
Batteries By Rayovac®.....	45
Carton Sealing Tape and Dispenser.....	45
Contact Cleaners.....	45-46
Coveralls.....	46
Degreasers.....	46
Drop Cloths.....	47
Hand Cleaners.....	47
Industrial Towels.....	47-48
Lubricants.....	48-49
Markers.....	50
Paints and Primers.....	50
Safety Supplies, Devices.....	50-52
Sealant, Epoxy, Glue.....	53
Sealing Compounds, Adhesive.....	53-54
Sheet Metal Screws.....	55
Surface Protection.....	56
Wasp, Hornet and Yellow Jacket Killers.....	56



ABRASIVE CLOTHS

All Purpose Cleaning Pads

For cleaning copper tubes and fittings. Made of nylon and will not rust. Can be used wet or dry. Leaves no residue and is long lasting.



ACP-10

CATALOG NO.	DESCRIPTION	UOM	ORDER MULTIPLE
ACP-10	All Purpose Cleaning Pads – pack of 10	PK	1

Abrasive Cloth

Aluminum oxide, high quality 120 grit, abrasive cloth to thoroughly clean copper and steel tubing. Works wet or dry. Exceeds industry standards for abrasive cloth.



SC-10

CATALOG NO.	DESCRIPTION	UOM	ORDER MULTIPLE
SC-10	Abrasive Cloth – 1-1/2" x 10 yds.	EA	1
SC-25	Abrasive Cloth – 1-1/2" x 25 yds.	EA	1

Grip-Cut™

Open mesh sand screen cloth. Aluminum oxide grain resin bonded to synthetic nylon cloth. 100% waterproof, but can also be used dry for sanding by hand or with portable tools. Most effective where clogging is a problem, such as soft materials. 180 grit.



SCM-5

CATALOG NO.	DESCRIPTION	UOM	ORDER MULTIPLE
SCM-5	Grip-Cut™ – 1-1/2" x 5 yds.	EA	1
SCM-10	Grip-Cut™ – 1-1/2" x 10 yds.	EA	1
SCM-25	Grip-Cut™ – 1-1/2" x 25 yds.	EA	1

AEROSOLS

Sure-Stick Heavy Duty Adhesive Spray

Wide web spray adhesive ideal for both temporary or permanent bonding. Waterproof, transparent and non-staining. Use for the toughest adhesive applications with leather, cardboard, most plastics, polyethylene sheeting and insulation in HVAC applications. Cleans with mineral spirits. Not for use on vinyl.



315-20

CATALOG NO.	DESCRIPTION	UOM	ORDER MULTIPLE
315-20	Sure-Stick Adhesive Spray – 12 oz. Aerosol	EA	12

CBC II Contact Cleaner

A plastic safe, non flammable electronic contact and circuit board cleaner. Dries fast, leaves no residue. No harsh fumes or odors.



362-16

CATALOG NO.	DESCRIPTION	UOM	ORDER MULTIPLE
362-16	CBC II Contact Cleaner – 10 oz. Aerosol	EA	12

Sweat-Free Pipe Insulation Spray

An aerosol spray on insulation specifically developed for cold water pipes, refrigeration and air conditioning lines. Stops sweating and dripping problems. Dries to a clean, white, flexible and water resistant coating. Adheres to galvanized, black iron, steel, brass, copper and PVC piping.



770-15

CATALOG NO.	DESCRIPTION	UOM	ORDER MULTIPLE
770-15	Sweat-Free Pipe Insulation – 15 oz. Aerosol	EA	12

Glass Cleaner

A foaming premium glass cleaner that powers through the toughest grease and grime on any glass or hard surface. Leaves a streak-free shine.



325-12

CATALOG NO.	DESCRIPTION	UOM	ORDER MULTIPLE
325-12	Glass Cleaner – 19 oz. Aerosol	EA	12

BATTERIES BY RAYOVAC®

Rayovac® is the Industrial Product Leader! Rayovac® is the leader in the industrial battery market and has been for years, with an estimated 50% share of the traditional industrial distribution channel. Rayovac® introduced the top-selling industrial flashlight to the market, and set the quality standard by which all other industrial flashlights are measured today. Whether your customer is searching for a toolbox-tough flashlight or high-performance batteries, Rayovac® offers a broad range of products to meet your needs.

Rayovac® Industrial Maximum Alkaline Batteries – Shrink Packed

- Same battery performance as the Contractor Packs at a lower cost
- Formulated specifically to exceed the everyday demands of industrial applications
- Outstanding dependability for “must work” applications



CATALOG NO.	DESCRIPTION	UOM	ORDER MULTIPLE
7-ALAA	Alkaline AA Battery – Shrink Packed, pack of 8	EA	8
7-ALAAA	Alkaline AAA Battery – Shrink Packed, pack of 8	EA	8
7-ALC	Alkaline C Battery – Shrink Packed, pack of 6	EA	6
7-ALD	Alkaline D Battery – Shrink Packed, pack of 6	EA	6
7-AL9V	Alkaline 9V Battery – Shrink Packed, pack of 6	EA	6

Rayovac® Lantern Batteries

- Dependable performance — for “must work” applications
- Available in General Purpose, Heavy Duty, and Alkaline Maximum



CATALOG NO.	DESCRIPTION	UOM	ORDER MULTIPLE
7-806	6 Volt Alkaline Maximum – Spring Terminals, pack of 6	EA	6

Rayovac® Industrial Maximum Alkaline Batteries — Contractor Packs

- Contractor preferred, clear, re-sealable package
- Greater battery per pack quantities command higher battery sales
- Displays much more readily than other competitive batteries
- In an HVAC test market, the Contractor Packs outsold the standard packs by a greater than 2 to 1 ratio!



CATALOG NO.	DESCRIPTION	UOM	ORDER MULTIPLE
7-ALAA-24	Alkaline AA Battery – Contractor Pack, pack of 24	EA	24
7-ALAAA-18	Alkaline AAA Battery – Contractor Pack, pack of 18	EA	18
7-ALC-12	Alkaline C Battery – Contractor Pack, pack of 12	EA	12
7-ALD-12	Alkaline D Battery – Contractor Pack, pack of 12	EA	12
7-AL9V-12	Alkaline 9V Battery – Contractor Pack, pack of 12	EA	12

CARTON SEALING TAPE AND DISPENSER

Carton Sealing Tape

This Clear 2.4 mil Sealing Tape is 2 in. nominal width and is 110 yds. in length



CATALOG NO.	DESCRIPTION	UOM	ORDER MULTIPLE
540-2110C	Carton Sealing Tape – 2” x 110 Yards – Clear	EA	36

Carton Tape Dispenser

A Heavy Duty Tape Dispenser that holds 2 in. Tape.



CATALOG NO.	DESCRIPTION	UOM	ORDER MULTIPLE
540-DISP	2” Carton Tape Dispenser	EA	1

CONTACT CLEANERS

HF™ Contact Cleaner

A petroleum distillate based precision cleaner with a flash point of 205°F. It can be an alternative to CFCs when applications require higher flashpoints.



CATALOG NO.	DESCRIPTION	UOM	ORDER MULTIPLE
CRC-4-140	HF™ Contact Cleaner – 11 oz.	EA	12

QD® Contact Cleaner

This contact cleaner is suitable for cleaning sensitive electronics and electrical equipment and does not leave any residue. It evaporates quickly and is safe to use on all plastics. This product is more useful where lower flashpoint cleaners are acceptable. The QD® Contact Cleaner is NSF K2 Registered.



CATALOG NO.	DESCRIPTION	UOM	ORDER MULTIPLE
CRC-4CF	QD® Contact Cleaner – 11 oz.	EA	12

CONTACT CLEANERS cont'd

Electronic Degreaser

This Advanced Technology Formula is non-chlorinated, non-conductive, non-corrosive and non-staining. It rapidly dissolves grease, oil and sludge for better efficiency of mechanical equipment. The Electronic Degreaser has no flash or fire point.



CATALOG NO.	DESCRIPTION	UOM	ORDER MULTIPLE
CRC-4NU	Electronic Degreaser – 15 oz.	EA	12

COVERALLS

ShuBee® Trishield Coverall

- Make a great first impression and protect your uniform
- Keep a professional appearance from the first job of the day to the last
- Exclusive Five-Pocket Design™ technology allows you to work more efficiently
- Triple layer material is breathable and durable
- Available in sizes L, XL, 2XL



CATALOG NO.	DESCRIPTION	UOM	ORDER MULTIPLE
COV-BRL	ShuBee® Trishield Coverall, Three Layer Polypropylene, Dark Blue, 5 Pocket Design, Large	EA	25
COV-BRXL	ShuBee® Trishield Coverall, Three Layer Polypropylene, Dark Blue, 5 Pocket Design, X-Large	EA	25
COV-BR2XL	ShuBee® Trishield Coverall, Three Layer Polypropylene, Dark Blue, 5 Pocket Design, 2X-Large	EA	25

KLEENGUARD®

KleenGuard® Personal Protective Equipment (PPE) enables rather than inhibits – allowing for maximum productivity and safety for you and your employees. When you're looking for an economical way to help protect your workers during potentially hazardous tasks, the KleenGuard brand A35 Disposable Coveralls, for Liquid and Particle Protection, are an excellent choice.

- Microporous film-laminated material helps protect against hazardous liquids (splashes) and dry particles (like dust and dirt)
- This protective suit has a zipper front and open wrists and ankles
- Available in sizes Medium to 3XL, meets ANSI / ISEA 101- 1996 standards
- PPE for hazardous liquid handling, pressure washing, maintenance, industrial / general manufacturing
- Meets American National Standards Institute and International Safety Equipment Association ANSI/ISEA 101-1996 sizing standard



CATALOG NO.	DESCRIPTION	UOM	ORDER MULTIPLE
COV-WPM	KleenGuard® (PPE), A35 Liquid a7 Particle Protection, Medium, Case/25	CS	1
COV-WPL	KleenGuard® (PPE), A35 Liquid a7 Particle Protection, Large, Case/25	CS	1
COV-WPXL	KleenGuard® (PPE), A35 Liquid a7 Particle Protection, X-Large, Case/25	CS	1
COV-WP2XL	KleenGuard® (PPE), A35 Liquid a7 Particle Protection, 2X-Large, Case/25	CS	1
COV-WP3XL	KleenGuard® (PPE), A35 Liquid a7 Particle Protection, 3X-Large, Case/25	CS	1

DEGREASERS

Heavy Duty Degreaser

This degreaser rapidly and effectively removes grease, oil, tar, and other residue to increase operating efficiency of equipment. It has no flash or fire point, making it an excellent alternative to 1,1,1-based cleaners. Please use caution on plastics.



CATALOG NO.	DESCRIPTION	UOM	ORDER MULTIPLE
CRC-7X	Heavy Duty Degreaser – 19 oz.	EA	12

Heavy Duty Degreaser II

The Heavy Duty Degreaser II is a non-chlorinated, zero VOC formula for cleaning where chlorinated solvents are prohibited. It has a high flashpoint of 180°F. This degreaser effectively removes soils with no residue build-up. Please exercise caution on plastics.



CATALOG NO.	DESCRIPTION	UOM	ORDER MULTIPLE
CRC-7-140	Heavy Duty Degreaser II – 15 oz.	EA	12

Chlor-Free® Degreaser

Non-chlorinated degreasing solvent which is used to remove oil, grease and other contaminants. It is especially useful for applications requiring a quick turnaround and where a low flashpoint solvent can be used.



CATALOG NO.	DESCRIPTION	UOM	ORDER MULTIPLE
CRC-7Z	Chlor-Free® Degreaser – 14 oz.	EA	12

Citrus Degreaser

The Citrus Degreaser has a new Low VOC Formula. The product removes grease, oil and lubricants with no water wash-off. It evaporates quickly and leaves no residue. The product gives off a pleasant citrus scent and is NSF C1 Registered.



CATALOG NO.	DESCRIPTION	UOM	ORDER MULTIPLE
CRC-7PS	Citrus Degreaser – 15 oz.	EA	12

DROP CLOTHS

Canvas Drop Cloths

Premium grade canvas drop cloths are made of first quality and full piece 100% cotton duck canvas fabric. The industrial grade canvas fabric is durable since it is tightly woven using virgin cotton yarn. The drop cloths are washable and reusable. Double stitched seams with heavy-duty rot resistant thread.



DC-4128

CATALOG NO.	DESCRIPTION	UOM	ORDER MULTIPLE
DC-4128	Canvas Drop Cloth - 4' x 12'	EA	1
DC-9128	Canvas Drop Cloth - 9' x 12'	EA	1

HAND CLEANERS

Fast Orange® Hand Cleaner

Three out of five people prefer Fast Orange® over other hand cleaners. The first biodegradable, waterless hand cleaner with aloe, lanolin, and jojoba. Smooth lotion and extra-fine pumice available. USDA Approved.



HCO-7 HCO-15

CATALOG NO.	DESCRIPTION	UOM	ORDER MULTIPLE
HCO-7	Fast Orange® – 7-1/2 fl. oz. Smooth Squeeze Bottle	EA	12
HCO-15	Fast Orange® – 15 oz. Smooth Squeeze Bottle	EA	12
HCO-128	Fast Orange® – 1 Gallon Smooth with Dispenser	EA	4
HCP-7	Fast Orange® – 7-1/2 fl. oz. Pumice Squeeze Bottle	EA	12
HCP-15	Fast Orange® – 15 oz. Pumice Squeeze Bottle	EA	12

Kimberly-Clark Waterless Hand Wipes

These wipes go wherever hands go to get dirty. Full sized 12" x 12" wipes for full sized cleaning. Natural cleaning agent is tough on grease, grime, ink, and paint. Dual textured – smooth for wiping on one side and tough for scrubbing on the other. More wipes with our 75 count bucket.



5-42272

WYPALL

CATALOG NO.	DESCRIPTION	UOM	ORDER MULTIPLE
5-42272	Kimberly-Clark Waterless Hand Wipes – Bucket	EA	6
5-4227R	Hand Wipe Refills, pack of 75	PK	6

INDUSTRIAL TOWELS

WypAll® Plus Towels

Absorbs grease, oil, water and solvents from floors, hands, parts, tools and machinery. Tough enough for extra heavy jobs. Comes in a convenient pop-up box of 100 towels.



5-05790

WYPALL

CATALOG NO.	DESCRIPTION	UOM	ORDER MULTIPLE
5-05790	WypAll® Plus Towels—White, pack of 100	PK	9

Kimtex® Shop **KIMTECH** Towels

Long lasting Kimtex® stands up to oils, chemicals and solvents better than ordinary shop towels. Cloth-like feel and performance. Towel size is 9-3/4" x 16-3/4". 100 towels/box. 5 boxes/case.



5-33570

CATALOG NO.	DESCRIPTION	UOM	ORDER MULTIPLE
5-33570	Kimtex® Shop Towels, pack of 100	PK	5

Teri® Reinforced Towels

The Teri® reinforced towels feature multi-ply tissue reinforced with nylon webbing for added strength on the job. Made from 100% recycled paper. Towel size is 9-3/4" x 16-3/4". Towel color is white. Comes in a convenient pop up box. 126 towels/box. 10 boxes/case.



5-34790

WYPALL

CATALOG NO.	DESCRIPTION	UOM	ORDER MULTIPLE
5-34790	Teri® Reinforced Towels, pack of 126	PK	10

WypAll® ShopPro X80 Towels

Like a rental shop towel, only more consistent. Engineered to feel like cloth and work even better. Absorbs more oil and water faster pound for pound than laundered shop towels. The ShopPro X80 is simply the heaviest duty towel in the Kimberly Clark line. 160 towels/box.



5-41041

WYPALL

CATALOG NO.	DESCRIPTION	UOM	ORDER MULTIPLE
5-41041	WypAll® ShopPro X80 Towels, pack of 160	PK	1

INDUSTRIAL TOWELS cont'd

WypAll® X70 Cloths

The economical alternative to scrap rags. Workhorse® Manufactured Rags is the first product to be made from Kimberly-Clark's advanced new material – Hydroknit®. Durable, rag tough construction stands up to any task. Can be re-used time and time again. Available in white or blue.



5-41455



CATALOG NO.	DESCRIPTION	UOM	ORDER MULTIPLE
5-41411	WypAll® X70 Cloths, 9-3/4" x 16-3/4" Blue, pack of 100	PK	10
5-41455	WypAll® X70 Cloths, 9-3/4" x 16-3/4" White, pack of 100	PK	10

Shop Towels

Heavy duty reusable towels. For wipe ups of grease, oil, water, etc. 100% cotton material is pre-shrunk and hemmed. Each towel measures 13" x 16".



ST-10

CATALOG NO.	DESCRIPTION	UOM	ORDER MULTIPLE
ST-4	Shop Towels, pack of 4	PK	1
ST-10	Shop Towels, pack of 10	PK	1
ST-24	Shop Towels, pack of 24	PK	1

Terry Towels

100% cotton. Minimum of 14" x 17". Pre-washed for absorbency, fully-hemmed, all-white, and reusable.



DTT-10

CATALOG NO.	DESCRIPTION	UOM	ORDER MULTIPLE
DTT-10	Terry Towels, pack of 10	PK	1
DTT-24	Terry Towels, pack of 24	PK	8

LUBRICANTS

Knock'er Loose® Penetrating Solvent

An industrial strength, low viscosity penetrant designed to rapidly loosen and free seized, bound or frozen fasteners. This product also quickly permeates rust, scale, gum, grease and corrosion. Independent tests reveal that it outperforms its competition.



CRC-1KB

CATALOG NO.	DESCRIPTION	UOM	ORDER MULTIPLE
CRC-1KB	Knock'er Loose® Penetrating Solvent – 13 oz.	EA	12

Screwloose® Industrial Penetrating Oil

A no compromise penetrant that attacks corrosion to free corroded fasteners and mechanical components. A super fast, powerful, concentrated penetrating solvent that loosens rust scale and corrosion and instantly penetrates minute and tightly fitted crevices.



CRC-8

CATALOG NO.	DESCRIPTION	UOM	ORDER MULTIPLE
CRC-8	Screwloose® Industrial Penetrating Oil – 11 oz.	EA	12

White Lithium Grease

White Lithium Grease has superior lubrication and durability in any weather or temperature. It is useful as a break in lubricant for bearings or as a general purpose lubricant and corrosion inhibitor for tools, machinery and equipment.



CRC-9

CATALOG NO.	DESCRIPTION	UOM	ORDER MULTIPLE
CRC-9	White Lithium Grease – 10 oz.	EA	12

Ultra Lite 3-36® Ultra Thin Non Staining Lubricant

Ultra thin, non staining lubricant that resists oil, dirt and dust build up. This lubricant also seals out moisture and protects against corrosion. It is excellent for drying out electrical components.



CRC-1

CATALOG NO.	DESCRIPTION	UOM	ORDER MULTIPLE
CRC-1	Ultra Lite 3-36® Ultra Thin Non Staining Lubricant – 11 oz.	EA	12

Cutting Oil

Cutting Oil is a superior thread cutting lubricant for use on all types of metals, including brass, copper and aluminum. For use on ferrous and non-ferrous metals. Clings to vertical surfaces for improved performance.



CRC-CF2

CATALOG NO.	DESCRIPTION	UOM	ORDER MULTIPLE
CRC-CF2	Cutting Oil - 16 oz. aerosol	EA	1

3-36® Multi-Purpose Lubricant & Corrosion Inhibitor

A multi-purpose petroleum based compound that forms a clear, thin film that lubricates and protects against wear and corrosion. The product also displaces moisture and cleans.



CRC-2

CATALOG NO.	DESCRIPTION	UOM	ORDER MULTIPLE
CRC-2	3-36® Multi-Purpose Lubricant & Corrosion Inhibitor – 11 oz.	EA	12

Zinc-It® Instant Cold Galvanize™ Zinc Rich Galvanize Coating

High-performance zinc coating that electrochemically bonds with ferrous metals to form a galvanic cell. The product also fights rust and corrosion and can be used as a touch-up for damaged galvanized coatings. Zinc-It® Instant Cold Galvanize™ Zinc Rich Galvanize Coating dries quickly.



CRC-5

CATALOG NO.	DESCRIPTION	UOM	ORDER MULTIPLE
CRC-5	Zinc-It® Instant Cold Galvanize™ Zinc Rich Galvanize Coating – 13 oz.	EA	12

WD-40®

Loosens rusted parts. Stops squeaks. Removes tar, grease and adhesives. Displaces moisture. Protects metal. New Smart Straw can.



741-002

741-001

CATALOG NO.	DESCRIPTION	UOM	ORDER MULTIPLE
741-001	WD-40 – 8 oz.	EA	12
741-002	WD-40 – 11 oz.	EA	12
741-003	WD-40, 14.4oz with E-Z Reach	EA	12

SP-400™ Corrosion Inhibitor

Long-term corrosion inhibitor that protects equipment subject to heat, humidity, chemicals or severely corrosive atmospheres. This product is best to use on machined surfaces and assemblies subjected to long periods of storage.



CRC-3

CATALOG NO.	DESCRIPTION	UOM	ORDER MULTIPLE
CRC-3	SP-400™ Corrosion Inhibitor – 10 oz.	EA	12

Sta-Plex™ Extreme Pressure Premium Red Grease

A superior multi-purpose certified lithium complex based grease which contains extreme pressure, anti-wear, and anti-oxidation additives. The product is very useful in high temperature and performance applications. The drop point is 500°F.



CRC-13

CATALOG NO.	DESCRIPTION	UOM	ORDER MULTIPLE
CRC-13	Sta-Plex™ Extreme Pressure Premium Red Grease – 14 oz.	EA	10

Heavy Duty Silicone Mold Release

This product provides maximum releases and is useful in difficult to remove parts. The Heavy Duty Silicone Mold Release is colorless, odorless, non-staining and non-corrosive.



CRC-6

CATALOG NO.	DESCRIPTION	UOM	ORDER MULTIPLE
CRC-6	Heavy Duty Silicone Mold Release – 12 oz.	EA	12

Pull-A-Spout Oiler

All purpose oiler with a 14in. telescoping spout. Zooms out for long shots, and in for short shots, even zooms around corners. Squeeze bottle action. Perfect lubricant for general industrial use. Contains four ounces of finest quality carbon free, rust and oxidation inhibited lubricating oil. Plastic container won't short out around electrical connections. No leakage.



CO-1

CATALOG NO.	DESCRIPTION	UOM	ORDER MULTIPLE
CO-1	Pull-A-Spout Oiler – 4 oz. – (Display)	EA	12
CR-1	Lubricant, Rust Breaker – 4 oz.	EA	12

MARKERS

Valve Action Marker

Large ink supply for increased mileage. Fast drying, smear and water resistant. Utilizes a patented valve-activated ink feed mechanism to supply ink as required, down to the last drop.



CATALOG NO.	DESCRIPTION	UOM	ORDER MULTIPLE
540-799	Valve Action Marker-Regular Tip – Red	EA	12
540-800	Valve Action Marker-Regular Tip – Black	EA	12

Felt Tip Markers

Sharpie® King-Sized Permanent Marker for metal, glass, paper and plastic. Durable metal body.



CATALOG NO.	DESCRIPTION	UOM	ORDER MULTIPLE
540-811B	Sharpie® King-Sized Marker	EA	12

Valve Action Paint Marker

Bright, crisp, opaque colors. The oil-based paint is quick drying and permanent on most surfaces. These markers also feature the patented valve-operated feed mechanism and a medium point.



CATALOG NO.	DESCRIPTION	UOM	ORDER MULTIPLE
540-805	Valve Action Paint Marker – Black	EA	12
540-806	Valve Action Paint Marker – Red	EA	12
540-807	Valve Action Paint Marker – White	EA	12
540-808	Valve Action Paint Marker – Yellow	EA	12

PAINTS AND PRIMERS

General Purpose Spray Paint

New, more complete line of professional quality fast drying spray paints. Color code compressors or refrigerant recovery cylinders to match standard refrigerant identifying colors. Touch up equipment housings. Product meets most recent VOC legislation and is currently compliant.



CATALOG NO.	DESCRIPTION	UOM	ORDER MULTIPLE
799-001	Spray Paint – Gloss Black – 12 oz.	EA	6
799-002	Spray Paint – Flat Black – 12 oz.	EA	6
799-003	Spray Paint – Gloss White – 12 oz.	EA	6
799-004	Spray Paint – Flat White – 12 oz.	EA	6
799-005	Spray Paint – Dark Machinery Gray – 12 oz.	EA	6
799-006	Spray Paint – Gray Primer – 12 oz.	EA	6
799-010	Spray Paint – Orange – 12 oz.	EA	6
799-011	Spray Paint – Aluminum (Silver) – 12 oz.	EA	6
799-012	Spray Paint – Zinc Rich Primer – 14 oz.	EA	6

Industrial Enamel

Finally an aerosol paint that sprays in any direction without clogging. We guarantee it! Dries tack free in 10 to 20 minutes; fully dry in just one hour. Excellent corrosion and solvent resistance. Resists heat up to 250°F. Now in 20 oz. cans. Product meets most recent VOC legislation and is currently compliant.



CATALOG NO.	DESCRIPTION	UOM	ORDER MULTIPLE
799-021	Industrial Enamel – Flat Black – 12 oz.	EA	6
799-022	Industrial Enamel – Gloss White – 12 oz.	EA	6
799-024	Industrial Enamel – Machinery Light Gray – 12 oz.	EA	6
799-025	Industrial Enamel – Aluminum – 12 oz.	EA	6

High Heat Spray Paint

An ultra high temperature coating formulated to resist temperatures up to 1300°F. Great for use on boilers, furnaces, steam pipes, chimney collars, compressors and engine manifolds. Product meets most recent VOC legislation and is currently compliant.



CATALOG NO.	DESCRIPTION	UOM	ORDER MULTIPLE
799-040	High Heat Spray Paint – Aluminum – 12 oz.	EA	6
799-041	High Heat Spray Paint – Black – 12 oz.	EA	6

SAFETY SUPPLIES, DEVICES

Cut Resistant Gloves

The 540-42545 coated safety gloves are made of ultra-high molecular weight polyethylene (UHMWPE) yarn with nylon and stretch fiber, which provide both cut resistance and a comfortable fit. They are rated with ANSI Level 2 / EN388 Level 3 Cut Resistance and CPPT = 686 grams. This glove is designed for protection against minor hand lacerations and abrasions. The 540-98237 coated safety gloves are made of ultra-high molecular weight polyethylene (UHMWPE) fiber, spun with glass, stainless steel and spandex. They offer ANSI Level 4 / EN388 Level 5 Cut Resistance and CPPT = 2,085 grams. It is great for industrial tasks that require protection against hand lacerations.

CATALOG NO.	DESCRIPTION	UOM	ORDER MULTIPLE
540-42545	Cut Resistant Glove, Level 3, Large, Black/White Color	PK	1
540-98237	Cut Resistant Glove, Level 5, Large, Black & Salt & Pepper Color	PK	1



SAFETY SUPPLIES, DEVICES cont'd

Latex Gloves

Disposable natural latex rubber which provide a natural feel and grip. Powdered.



23010

CATALOG NO.	DESCRIPTION	UOM	ORDER MULTIPLE
23010	Latex Gloves, pack of 50 pairs	PK	1

Nitrile Gloves

Foam control gloves for industrial use that provide a high level of wet and dry grip. Standard in applications where tactile sensitivity is required.



540-1005L

CATALOG NO.	DESCRIPTION	UOM	ORDER MULTIPLE
540-1005L	Nitrile Gloves - Large, 1 pair per pack	EA	1

Heavy Duty Work Gloves

Your choice of durable work gloves. Washable, breathable, and durable for everyday use.



540-HU1L

CATALOG NO.	DESCRIPTION	UOM	ORDER MULTIPLE
540-HU1L	Heavy Utility Gloves - Large, 1 pair per pack	PK	1

Shoe Covers

Slip these shoe covers on in seconds to protect carpet, tile, or wood from dirt and scuff marks. Customers will appreciate your professional appearance.



SC-1

CATALOG NO.	DESCRIPTION	UOM	ORDER MULTIPLE
SC-1	Navy Blue Shoe Covers, pack of 50 pairs	PK	1
SC-1WP	Waterproof Shoe Covers, pack of 50 pairs	PK	1
SC-1SHU	Dark Blue Shoe Covers, pack of 50 pairs	PK	1

Leather Work Gloves

Versatile leather work gloves ideal for many industrial jobs. These leather work gloves offer: wing thumb pattern, continuous pull patch, seamless full leather index finger, leather knuckle strap, leather finger tips with elastic gather on back. Generously sized for a good working fit.

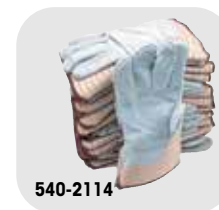

540-2114

CATALOG NO.	DESCRIPTION	UOM	ORDER MULTIPLE
540-2114	Leather Glove w/Safety Cuff, 1 pair per pack	EA	12

Powder Free Unlined Nitrile Disposable Gloves

- Latex Free
- Oil Resistant
- 100 gloves per box



NG-BLL

CATALOG NO.	DESCRIPTION	UOM	ORDER MULTIPLE
NG-BLL	Powder Free Unlined Nitrile Disposable Gloves, Blue, 8 mil, Large, pack of 100	PK	10
NG-BLXL	Powder Free Unlined Nitrile Disposable Gloves, Blue, 8 mil, X-Large, pack of 100	PK	10
NG-BL2XL	Powder Free Unlined Nitrile Disposable Gloves, Blue, 8 mil, 2X-Large, pack of 100	PK	10

ShuBee® Dark Blue Shoe Covers

Designed specifically for the service industry professionals. Strong and made of breathable, cloth-like material. Fit up to a size 18 work boot. Come in dispenser boxes and are easy to use.



SC-BRSHU

CATALOG NO.	DESCRIPTION	UOM	ORDER MULTIPLE
SC-BRSHU	ShuBee® Dark Blue Shoe Covers, 16 in. x 6-3/4 in., pack of 50 pairs	PK	1
SC-WPSHU	ShuBee® Dark Blue Shoe Waterproof Covers, 17 in. x 8 in., pack of 40 pairs	PK	1

ShuBee® Black Gauntlet® Silver Edition Nitrile Disposable Gloves

- 3x the puncture resistance of latex or vinyl
- Superb tensile strength
- Powder free to not compromise adhesive seals or fresh paint
- Latex free alternative for latex-sensitive workers
- Great barrier protection
- Textured for a reliable grip, wet or dry
- 9" cuff
- Oil resistant

CATALOG NO.	DESCRIPTION	UOM	ORDER MULTIPLE
NG-BKL	ShuBee® Black Gauntlet Silver Edition Nitrile Disposable Gloves, Black, Powder Free, 5 mil, Large, Pack of 100	PK	10
NG-BKXL	ShuBee® Black Gauntlet Silver Edition Nitrile Disposable Gloves, Black, Powder Free, 5 mil, X-Large, Pack of 100	PK	10
NG-BK2XL	ShuBee® Black Gauntlet Silver Edition Nitrile Disposable Gloves, Black, Powder Free, 5 mil, 2X-Large, Pack of 100	PK	10



NG-BKL



SAFETY SUPPLIES, DEVICES cont'd

Jackson Safety G40 Foam Nitrile Coated Gloves

- 25% better productivity than leather, with excellent grip and dexterity for rough tasks
- Maintains the highest EN388 abrasion rating, even after five washes
- Better oil and industrial grease grip (almost 3x better than previous G40 nitrile gloves)
- Seamless knit nylon back for comfort, available in a variety of sizes (ranging from Medium up to 2 Extra Large)
- Pack of 12 Pairs



CATALOG NO.	DESCRIPTION	UOM	ORDER MULTIPLE
G-NCM	Jackson Safety G40 Foam Nitrile Coated Gloves, PK Medium, 12 pairs per pack		1
G-NCL	Jackson Safety G40 Foam Nitrile Coated Gloves, PK Large, 12 pairs per pack		1
G-NCXL	Jackson Safety G40 Foam Nitrile Coated Gloves, PK X-Large, 12 pairs per pack		1
G-NC2XL	Jackson Safety G40 Foam Nitrile Coated Gloves, PK 2X-Large, 12 pairs per pack		1

Box Handler Gloves

Washable, breathable, and durable for everyday use.



CATALOG NO.	DESCRIPTION	UOM	ORDER MULTIPLE
540-BH1L	Box Handler Gloves - Large, 1 pair per pack	PK	6

Dust Masks

- Extremely lightweight, disposable, nuisance dust mask thats easy to breathe.
- For non-toxic particles such as dust, pollen, sawdust, etc. found in workshops, workplaces or households.
- Adjustable metal nose-clips to fit individual facial contours.
- Comfortable elastic headband that won't pinch.



CATALOG NO.	DESCRIPTION	UOM	ORDER MULTIPLE
5-500	Dust Masks, pack of 50	PK	1

First Aid Kits

10 and 25-unit first aid kits packaged in economy plastic boxes to assist when industrial accidents occur.



CATALOG NO.	DESCRIPTION	UOM	ORDER MULTIPLE
FAK-10	10-Unit First Aid Kit	EA	1
FAK-25	25-Unit First Aid Kit	EA	1

Jackson Safety G40 Latex Coated Gloves

- Breathable cotton back for comfort; Silicone-free
- Crinkled latex coating for excellent grip
- Highest EN388 tear resistance rating; Excellent durability
- Separate right and left gloves in a pair for a snug fit
- Pack of 12 pairs



CATALOG NO.	DESCRIPTION	UOM	ORDER MULTIPLE
G-LCM	Jackson Safety G40 Latex Coated Gloves, Medium, 12 pairs per pack	PK	1
G-LCL	Jackson Safety G40 Latex Coated Gloves, Large, 12 pairs per pack	PK	1
G-LCXL	Jackson Safety G40 Latex Coated Gloves, X-Large, 12 pairs per pack	PK	1
G-LC2XL	Jackson Safety G40 Latex Coated Gloves, 2X-Large, 12 pairs per pack	PK	1

Jackson Safety V30 Nemesis Safety Glasses

- Feature a sporty, flexible, lightweight design that your employees will be happy to wear; they have a stylish, sporty look and feel
- Meets ANSI Z87.1+ standards for personal eye protection
- Polycarbonate lenses provide 99.9% UVA/UVB/UVC protection
- Patented FLEX-DRY designed to be extremely flexible, to channel sweat away from the eyes, and to help prevent slippage down the nose - all for long-term comfort

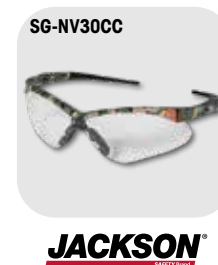

CATALOG NO.	DESCRIPTION	UOM	ORDER MULTIPLE
SG-NV30CC	Jackson Safety V30 Nemesis Safety Glasses - Clear Anti-Fog Lenses with Camo Frame, Case/12	CS	1
SG-NV30CB	Jackson Safety V30 Nemesis Safety Glasses - Smoke Anti-Fog Lenses with Camo Frame, Case/12	CS	1
SG-NV30BC	Jackson Safety V30 Nemesis Safety Glasses - Clear Lenses with Black Frame, Case/12	CS	1
SG-NV30B	Jackson Safety V30 Nemesis Safety Glasses - Clear Anti-Fog Lenses with Black Frame, Case/12	CS	1

Hand Warmer

Air-activated hand warmers deliver hours of warmth and relief from cold weather. Once the package is opened, an exothermic reaction begins providing an effective defense against the winter cold.



CATALOG NO.	DESCRIPTION	UOM	ORDER MULTIPLE
HW-10P	Hand Warmer, pack of 10	PK	1

SEALANT, EPOXY, GLUE

Thread Sealant with PTFE

General purpose sealant with the lubricity of PTFE for metal pipes. Won't shred like PTFE Tape. Allows easy disassembly. Resists common shop fluids. 60° to 400°F temp. resistance. Pressure resistance of 5000 PSI.



CATALOG NO.	DESCRIPTION	UOM	ORDER MULTIPLE
7-80632	Thread Sealant – 1/4 Pint Brush Can	EA	12
7-80633	Thread Sealant – 1 Pint Brush Can., 12 per pack	EA	12

Wagner Adhesive Sealant

For refrigerant sealing. Eliminates fastener loosening, leakage, and corrosion. Cures between thread flanks to seal against leakage and prevents thread corrosion. Offers sealing with maximum solvent resistance to the action of refrigerant (11, 12 and 22), ammonia and sulfur dioxide. Withstands corrosive liquids used in metal finishings and process industries. Ideal sealant for refrigeration, A/C, and process equipment using corrosive chemicals.



CATALOG NO.	DESCRIPTION	UOM	ORDER MULTIPLE
CAS-2712	Wagner Adhesive Sealant – 0.34 fl. oz.	EA	12

Super Glue

This adhesive can be used on dirty, greasy surfaces and the medium viscosity penetrates into preassembled and close fitting parts. It can be used on aluminum, metal, rubber, and most plastics for most tough jobs.



CATALOG NO.	DESCRIPTION	UOM	ORDER MULTIPLE
DEP052	Super Glue – 2 Gram Tube	EA	12

Fast Cure Epoxy

An easy-to-use, two part putty you simply mix and mold like clay. No complicated weighing or measuring required. Easy 1:1 cut-what-you-need mix ratio. Form it into any shape. It hardens in one hour and makes a final, steel-hard cure in 12 hours and can be sanded, drilled, machined, sawed and painted. Use on metal, wood, brick, stone, concrete, fiberglass, porcelain, tile and most plastics. Cures under water. 1.0 lb.

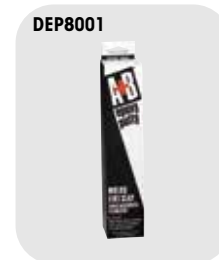

CATALOG NO.	DESCRIPTION	UOM	ORDER MULTIPLE
DEP8001	Gray Epoxy Putty – 1 lb. Kit	EA	24
DEP8002	White Epoxy Putty – 1 lb. Kit	EA	24

J-B Weld

The world's finest cold-weld compound for use when welding or soldering is out of the question due to cost, down time for repairs, or technical or environmental considerations. A remarkably easy, convenient, and inexpensive alternative to welding, soldering, and brazing. Literally pennies per use.



CATALOG NO.	DESCRIPTION	UOM	ORDER MULTIPLE
JB8265	J-B Weld 2 Part Epoxy	EA	6

SEALING COMPOUNDS, ADHESIVE

Flexi-Patch™

Flexi-Patch™ is an easy to use flexible repair patch ideal for repairing almost any surface. It cures quickly using only UV light from sunlight or a UV flashlight for a long lasting, permanent repair. Flexi-Patch is a fiberglass-reinforced polyester ideal for use on PVC, plastics, metal, wood, concrete and more. It's the easy way to permanently patch almost any surface. It dries hard for permanent repair. Can be drilled, tapped and painted once dry.



CATALOG NO.	DESCRIPTION	UOM	ORDER MULTIPLE
FP-36	Flexi-Patch fiberglass patch	EA	20

Foam Sealant – One Component

One component closed-cell expanding polyurethane foam sealant for lineal caulking applications. Air-moisture cure. Tack free in 20 minutes; fully cured in 12 hours. Paintable. Use for insulating and sealing around windows, doors, pipes, ducts and vents. Non-toxic when cured. Paint to protect from UV exposure. "R" value 4.7 (1" thickness). Foam contains fire retarding chemical and is U.L. Listed but not rated as a firestop product. Environmental concerns have led us to replace CFC's and HCFC's with hydrocarbon material in our one component foam products. See instructions on each product to ensure safe use and quality results.



CATALOG NO.	DESCRIPTION	UOM	ORDER MULTIPLE
01714	Foam Sealant – 12 oz. Can – Yields 275' (3/8" bead)	EA	12
01724	Foam Sealant – 20 oz. Can – Yields 460' (3/8" bead)	EA	12

SEALING COMPOUNDS, ADHESIVE cont'd

Firestop Products for Class A Buildings

U.L. Classified. Code Approved. Seal penetrations of plumbing, refrigeration and AC lines, ducts, vents and electrical cable through fire-rated floors, walls and ceilings. Easy-to-use, non-shrinking, non-toxic and permanently flexible. Blocks fire, gas, smoke, air and water migration. Use ceramic fiber filler together with putty or caulk for thick penetrations. Technical bulletins available.



CATALOG NO.	DESCRIPTION	UOM	ORDER MULTIPLE
16491	Firestop Caulk – Red – 10.3 fl. oz. cartridge	EA	12

Caulk Gun

Caulk guns can be used to hold the sealant to seal duct work.



CATALOG NO.	DESCRIPTION	UOM	ORDER MULTIPLE
7-100	Caulk Gun – Super Ratchet Type	EA	12
7-200	Caulk Gun – Standard Duty	EA	1

High Temp Red Silicone Sealant

A one part non-slumping paste that cures to a tough, rubbery solid at room temperature. Formulated to perform at temperatures ranging from -85°F to 500°F for continuous operation, and to 600°F for intermittent exposure. Tack free cure time – 15 minutes. Full cure time – 24 hours.



CATALOG NO.	DESCRIPTION	UOM	ORDER MULTIPLE
7-4300	High Temp Red Silicone Sealant – 10.1 oz. Cartridge	EA	12

25 Year Acrylic Latex Painter's Caulk

For both interior and exterior use. DiversiTech's 25 Year Acrylic Latex Painter's Caulk forms a tough, paintable resilient bond to all building material surfaces. Excellent resistance to water, weathering and moisture vapor.



CATALOG NO.	DESCRIPTION	UOM	ORDER MULTIPLE
7-4500	White Acrylic Latex Caulk – 10.1 oz. Cartridge	EA	12
7-4400	Clear Acrylic Latex Caulk – 10.1 oz. Cartridge	EA	12

Pro-Air Industrial Grade Spray Adhesive

A clear, pressure sensitive aerosol adhesive with exceptional tack and shear strength characteristics. An excellent choice for most permanent adhesive applications: duct liner and wrap, sheet aluminum, fiberglass insulation board, and much more. The aerosol package offers a specially designed web spray pattern for even, controlled distribution. Flammability meets aerosol flame extension test requirements. Coverage is approximately 90-100 square feet per pound.



CATALOG NO.	DESCRIPTION	UOM	ORDER MULTIPLE
GP1-40BL	Pro-Air Spray Adhesive – 38 lb. Disposable Cylinder	EA	1
GN-23H	Spray Gun	EA	1

DiversiGum Sealing Compound

6-202-2

Non-hardening. For plugging openings through foundations or around refrigeration tube entry.



CATALOG NO.	DESCRIPTION	UOM	ORDER MULTIPLE
6-202-1	DiversiGum Sealing Compound – 1 lb. Slug	EA	24
6-202-2	DiversiGum Sealing Compound – 2 lb. Slug	EA	20
AG-25	DiversiGum Sealing Compound – 3/8" x 25' Caulking Cord	EA	12

Silicone Sealant

Food grade 100% RTV Silicone Sealant. Can be used in applications for continuous use to 450°F. UV and water resistant. Long-term flexibility. Non-paintable. Available in 10.3 fl. oz. tube for use in standard caulk gun or in 3 fl. oz. squeeze tube.



CATALOG NO.	DESCRIPTION	UOM	ORDER MULTIPLE
7-4000	Clear Silicone Sealant – 10.3 fl. oz. Tube	EA	12
7-4001	Clear Silicone Sealant – 3 fl. oz. Squeeze Tube	EA	48
7-4100	White Silicone Sealant – 10.3 fl. oz. Tube	EA	12
7-4200	Aluminum Silicone Sealant – 10.3 fl. oz. Tube	EA	12
7-80045	Pipe Joint Compound – 6 fl. oz. Tube	EA	12

Pro-Air Duct Sealant – UL 181 AM-BM Listed

Water-based fiber-reinforced duct sealant/mastic formulated for indoor/outdoor use. Meets U.L. Class 1 rating and local codes while featuring long term flexibility and strength. Use on metal heating, ventilating, and A/C duct systems; as well as fiberglass duct board systems and flex duct systems. Recommended for use to 10" of water column pressure without the need for fiberglass mesh reinforcement.



CATALOG NO.	DESCRIPTION	UOM	ORDER MULTIPLE
800-008	Pro-Air Duct Sealant – 1/10 Gallon Tube – 10.5 oz.	EA	12
800-009	Pro-Air Duct Sealant – 1 Gallon Pail	EA	4

Black Jack® Roof Cement

Black Jack® All-Weather Roof Cement is an asphalt based patching compound designed to repair cracks, splits, seams and holes in roofing materials. It also works great in new construction and in setting flashings, drip edges and roofing material edges.

- Use in wet or dry conditions
- Seals flashings, and other roof projections
- Fiber reinforced
- Thick trowel grade



CATALOG NO.	DESCRIPTION	UOM	ORDER MULTIPLE
RM-1G	Black Jack® All Weather Roof Cement – 1 gallon	EA	6
RM-10	Black Jack® All Weather Roof Cement – 10 oz. tube	EA	12

SHEET METAL SCREWS

Masonry Bit

This bit is suitable for brick, tile, slate, cement, and cinder block. This bit is a nice addition to the toolbox.



CATALOG NO.	DESCRIPTION	UOM	ORDER MULTIPLE
540-DB6	Masonry Bit – 3/16" x 6"	EA	1

Anchor Kit

Plastic anchor kit for sheet rock applications. Kit includes 100 anchors, screws and 1 masonry bit.



CATALOG NO.	DESCRIPTION	UOM	ORDER MULTIPLE
540-AK100	Anchor size 1/4 x 1, Screw Size 10 x 1-1/4 HWH Head Size 5/16 hex	EA	1

Sheet Metal Screws – Drill Point

Self-drilling, self-tapping. Hex washer head. Produces the optimum hole size, resulting in a tighter fit. Made from special heat treated steel for extra strength. Packaged in resealable plastic cartons.



CATALOG NO.	DESCRIPTION	HEAD SIZE	UOM	ORDER MULTIPLE
5-SCR61-2DP	6 x 1/2 Drill Point, pack of 1,000	1/4"	PK	1
5-SCR61-2DPBULK	6 x 1/2 Drill Point – Bulk, pack of 15,000	1/4"	PK	1
5-SCR81-2DP	8 x 1/2 Drill Point, pack of 1,000	1/4"	PK	1
5-SCR81-2DPBULK	8 x 1/2 Drill Point – Bulk, pack of 10,000	1/4"	PK	1
5-SCR83-4DP	8 x 3/4 Drill Point, pack of 500	1/4"	PK	1
5-SCR83-4DPBULK	8 x 3/4 Drill Point – Bulk, pack of 10,000	1/4"	PK	1
5-SCR81DP	8 x 1 Drill Point, pack of 500	1/4"	PK	1
5-SCR81DPBULK	8 x 1 Drill Point – Bulk, pack of 7,500	1/4"	PK	1
5-SCR101-2DP	10 x 1/2 Drill Point, pack of 500	5/16"	PK	1
5-SCR101-2DPBULK	10 x 1/2 Drill Point – Bulk, pack of 10,000	5/16"	PK	1
5-SCR103-4DP	10 x 3/4 Drill Point, pack of 500	5/16"	PK	1
5-SCR103-4DP100	10 x 3/4 Drill Point, pack of 100	5/16"	PK	1
5-SCR103-4DPBULK	10 x 3/4 Drill Point – Bulk, pack of 5,000	3/4"	PK	1
5-SCR101DP	10 x 1 Drill Point, pack of 500	5/16"	PK	1
5-SCR101DPBULK	10 x 1 Drill Point – Bulk, pack of 5,000	5/16"	PK	1
5-SCR101-12DP	10 x 1-1/2 Drill Point, pack of 250	5/16"	PK	1
5-SCR101-12DPBULK	10 x 1-1/2 Drill Point – Bulk, pack of 3,500	5/16"	PK	1
5-SCR102DP	10 x 2 Drill Point, pack of 350	5/16"	PK	1
5-SCR102DPBULK	10 x 2 Drill Point – Bulk, pack of 2,500	5/16"	PK	1

Masonry Screw

This product comes in a pack of 250 and is suitable for brick, tile, slate, cement, and cinder block. The screws are a nice addition to the toolbox.



CATALOG NO.	DESCRIPTION	UOM	ORDER MULTIPLE
5-SCRMS	Masonry Screw – 1/4" x 1-1/4", pack of 250	PK	1

Sheet Metal Screws – Taper Point

Hex washer slotted head. Burr-free. Full 5/16" head will not strip out of hex driver opening. Heat treated tapered point will not break or "walk". Packaged in resealable plastic cartons.



CATALOG NO.	DESCRIPTION	UOM	ORDER MULTIPLE
5-SCR63-8	6 x 3/8 Taper Point, pack of 1,000	PK	1
5-SCR63-8BULK	6 x 3/8 Taper Point – Bulk, pack of 20,000	PK	1
5-SCR71-2	7 x 1/2 Taper Point, pack of 1,000	PK	1
5-SCR71-2BULK	7 x 1/2 Taper Point – Bulk, pack of 15,000	PK	1
5-SCR81-2	8 x 1/2 Taper Point, pack of 1,000	PK	1
5-SCR81-25M	8 x 1/2 Taper Point, pack of 5,000	PK	1
5-SCR81-2BULK	8 x 1/2 Taper Point – Bulk, pack of 12,000	PK	1
5-SCR83-4	8 x 3/4 Taper Point, pack of 1,000	PK	1
5-SCR83-4BULK	8 x 3/4 Taper Point – Bulk, pack of 10,000	PK	1
5-SCR81	8 x 1 Taper Point, pack of 500	PK	1
5-SCR81BULK	8 x 1 Taper Point – Bulk, pack of 7,500	PK	1
5-SCR81-12	8 x 1-1/2 Taper Point, pack of 250	PK	1
5-SCR81-12-100	8 x 1-1/2 Taper Point, pack of 100	PK	1
5-SCR81-12W	8 x 1-1/2 Taper Point w/White Head, pack of 250	PK	1
5-SCR81-12BULK	8 x 1-1/2 Taper Point – Bulk, pack of 5,000	PK	1
5-SCR82-100	8 x 2 Taper Point, pack of 100	PK	1
5-SCR82	8 x 2 Taper Point, pack of 350	PK	1
5-SCR82W	8 x 2 Taper Point w/White Head, pack of 250	PK	1
5-SCR82BULK	8 x 2 Taper Point – Bulk, pack of 3,000	PK	1
5-SCR103-4	10 x 3/4 Taper Point, pack of 1,000	PK	1
5-SCR103-4BULK	10 x 3/4 Taper Point – Bulk, pack of 10,000	PK	1
5-SCR101	10 x 1 Taper Point, pack of 500	PK	1
5-SCR101-2	10 x 1/2 Taper Point, pack of 1,000	PK	1
5-SCR101BULK	10 x 1 Taper Point – Bulk, pack of 7,000	PK	1

SURFACE PROTECTION

ShuBee® Surface Liner

- Specifically for cured hardwood floors and any other hard surfaces
- Light tack adhesive to avoid residue on client's floors
- Reverse wound for easy application and clean up
- 40" x 54' - 180 square feet
- Each box contains an EZ Trim Tool for easy cutting
- Waterproof
- Padded for extra protection



CATALOG NO.	DESCRIPTION	UOM	ORDER MULTIPLE
SPT-W	Surface Liner, White, 54 ft. Roll	EA	1

WASP, HORNET, AND YELLOW JACKET KILLERS

Sting Less Wasp & Hornet Killer

Kills wasps, hornets and yellow jackets. Very fast-acting when insects are hit directly. Allow approximately 24 hours for those that were not directly hit. This container delivers a 20-foot jet blast to knock down the insects and allow for the user to remain at a safe distance.

436-20



CATALOG NO.	DESCRIPTION	UOM	ORDER MULTIPLE
436-20	Sting Less Wasp & Hornet Spray – 14 oz. Aerosol	EA	12

Wasp & Hornet Killer by ENFORCER

Enforcer's Wasp & Hornet Killer shoots a 20-foot jet blast for instant knockdown of wasps, hornets, and yellow jackets. Enforcer's Wasp & Yellow Jacket Foam is a 20-foot blast of blanketing foam that plugs yellow jacket holes and clings to wasp and hornet nests, preventing their escape.

8-WH16



8-FWH16

CATALOG NO.	DESCRIPTION	UOM	ORDER MULTIPLE
8-WH16	Enforcer Wasp & Hornet Killer – 16 oz. Aerosol	EA	12
8-FWH16	Enforcer Wasp & Yellow Jacket Foam – 16 oz. Aerosol	EA	12

DEVCO



Anchors.....	70
Boxes, Rings, and Covers.....	72-73
Cable Connectors.....	73-74
Cable Ties and Accessories.....	74-75
Conduit Fittings.....	75-76
DEVCO Racks Master Item List (By Racks).....	62-63
General Tools.....	76
High Temperature Solderless Terminals.....	68
Nuts and Bolts.....	77-78
Plan-O-Gram for DEVCO Elec Rack.....	59
Plan-O-Gram for DEVCO Ezc Rack.....	60
Plan-O-Gram for DEVCO Combo Rack.....	61
Plastic Anchor Kits.....	71
Power Cords and Work Lights.....	78
Screws.....	78
Slip-On Solderless Terminals.....	64-65
Special Purpose Solderless Terminals.....	65-66
Specialty Fasteners.....	79
Specialty Fittings.....	80
Standard Solderless Terminals.....	66-67
Storage Containers.....	80
Tapes.....	80
Terminal Kits.....	69
Testers, Leads, Clips, Fuses.....	81
Wire.....	81-82
Wiring Devices.....	82-86

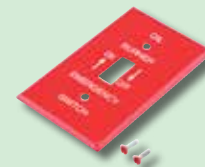

How to sell DEVCO® products

DEVCO® merchandising displays are an easy and attractive way to showcase a variety of DEVCO® products in your store. Offered in three different versions, each display rack includes everything you need to create extra sales for your business.

Easy to Display

DEVCO® provides turnkey merchandising solutions for wholesale distribution. Attractive, easy to set-up merchandising displays provide a great way to highlight DEVCO® products and make it easy for customers to find what they need. The point of sale display merchandises the products, enabling the distributor to add additional sales.

The products merchandised on the carousel are impulse buy items. The items are packed so they cost the contractor only a few dollars, and most are less than \$10 each.

Easy to Profit

DEVCO® displays provide a typical distributor branch with easy add-on sales that build profits. Each display can generate significant sales and margins for the store while providing contractors with the parts they need to finish the job. These self-service displays are a great way to increase revenue with minimal effort.

The Perfect Plan

Each DEVCO® Merchandising display comes with a complete plan-o-gram to make merchandising it simple and fast. And there are three different versions available so you can choose the display that's right for your business and customers.

And when you purchase the DEVCO® products to fill it up, the merchandising rack is **loaned free of charge.**



Display Rack	Featured Products
EZC	Solderless terminals, ground connectors, fasteners, anchor kits, cable ties, washers, hex nuts, cable clamps, sheet metal screws and hose clamps
Electrical	Ground adaptors, outlets, boxes, bushings, cable connectors, extension rings, indicator lights, plugs and connectors, receptacles, reducing washers, toggle switches and hook up wire
Combo	Solderless terminals, insulated rings, ground adaptors, covers, reducing washers, plugs and connectors, hook up wire, fasteners, hex nuts and self drilling screws

PLAN-O-GRAM FOR DEVCO ELEC RACK (MKT-POP-DEVELEC)

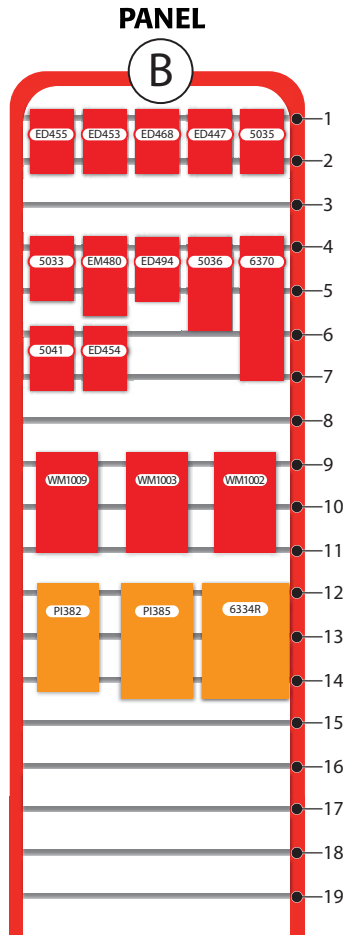
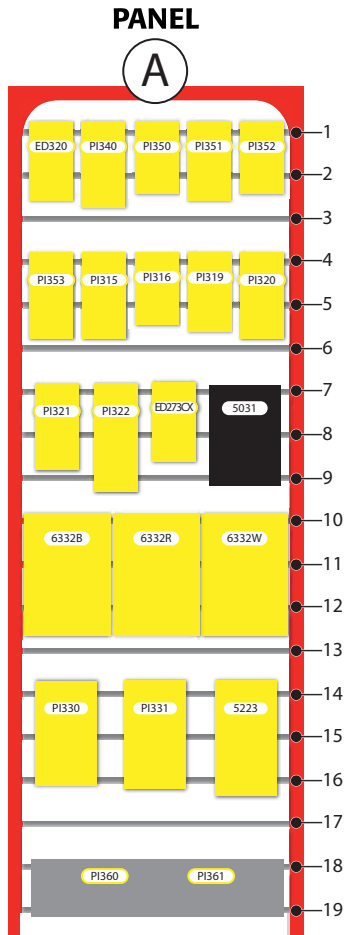

MKT-POP-DEVELEC

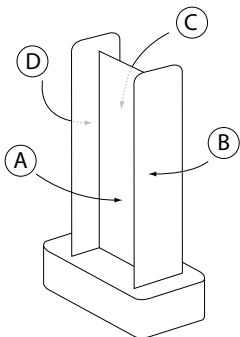
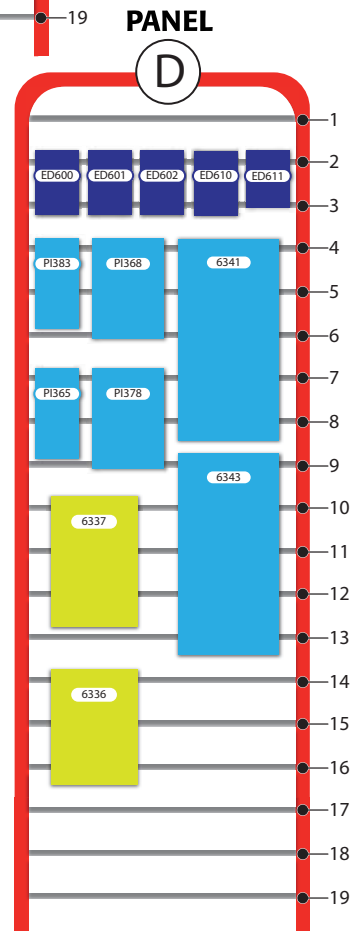
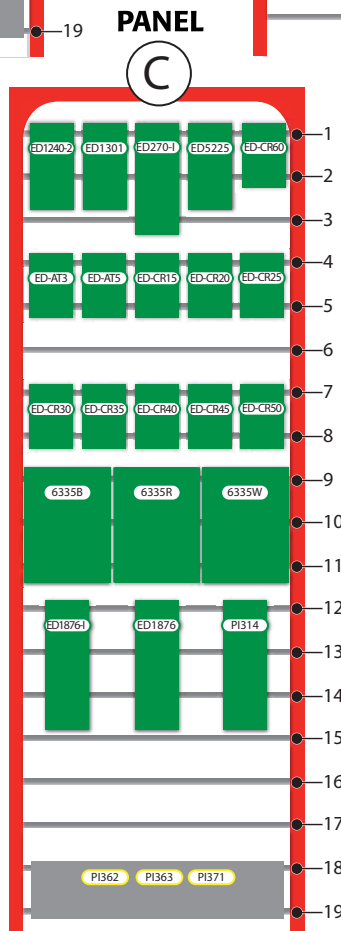

MKT-POP-DEVELEC
Merchandising Rack
72" x 22" x 20.5"

NOTE: Item numbers in **RED** indicate Made in the U.S.A.



PLAN-O-GRAM FOR DEVCO EZC RACK (MKT-POP-DEVEZC)

PANEL

A

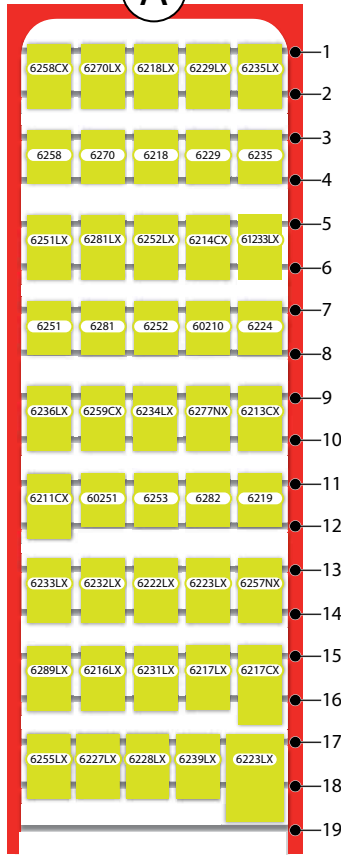

PANEL

B

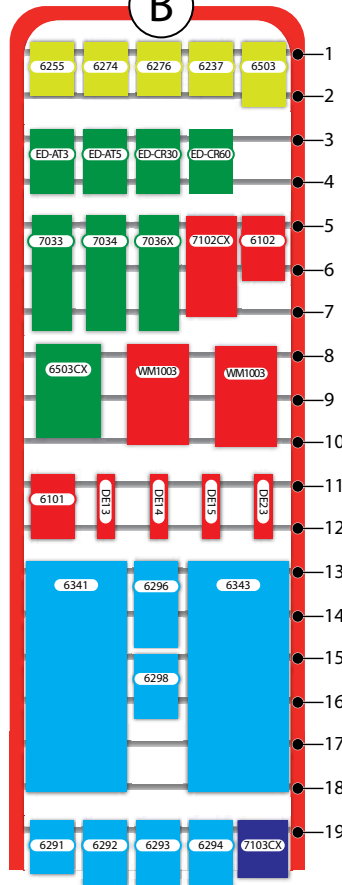

PANEL

C

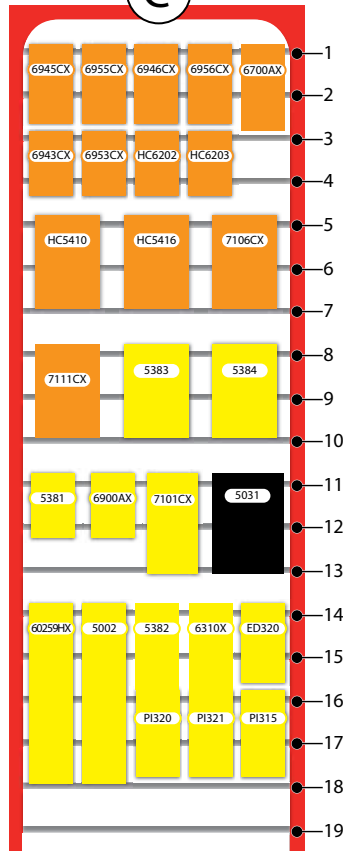

PANEL

D

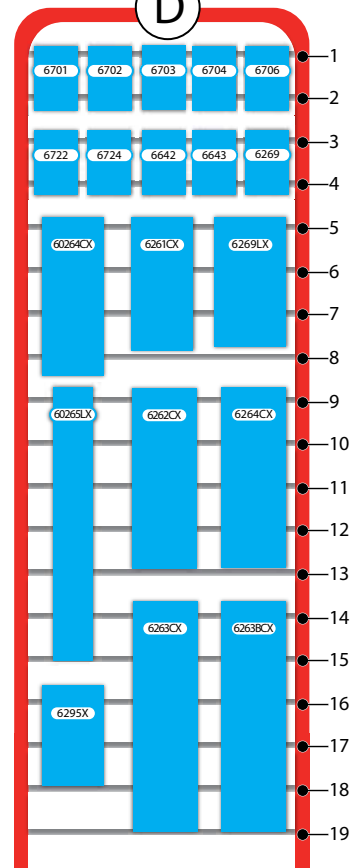

MKT-POP-DEVEZC

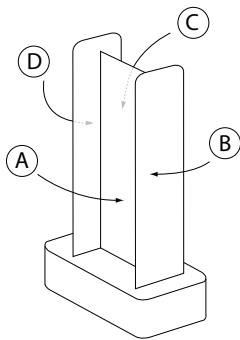

MKT-POP-DEVEZC
Merchandising Rack
72" x 22" x 20.5"

PLAN-O-GRAM FOR DEVCO COMBO RACK (MKT-POP-DEVCOMBO)

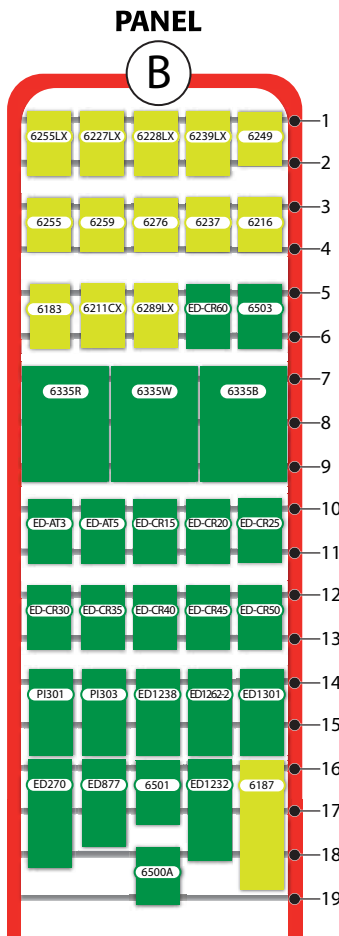
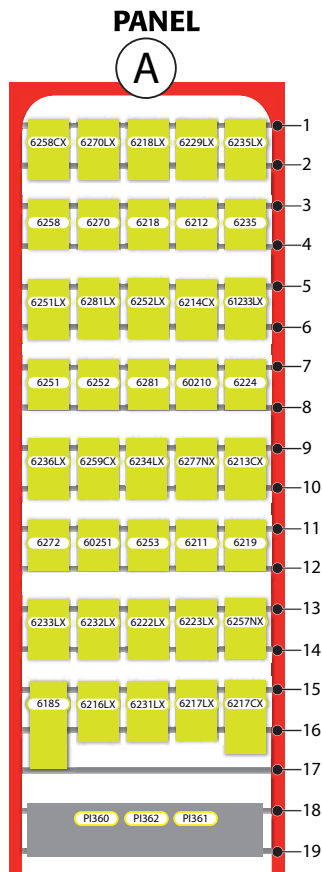

MKT-POP-DEVCOMBO

PANEL C

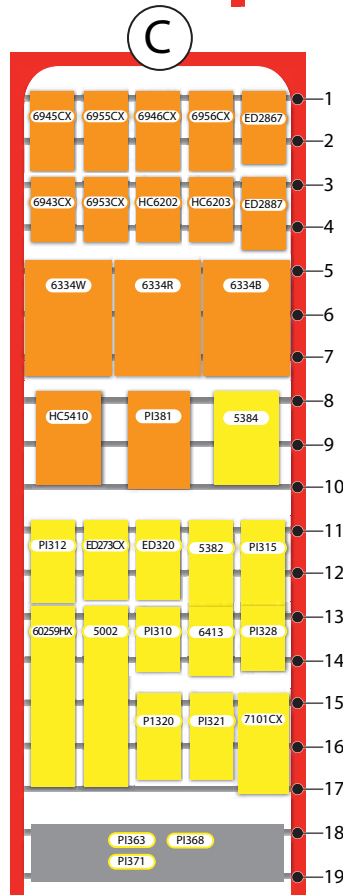

PANEL D

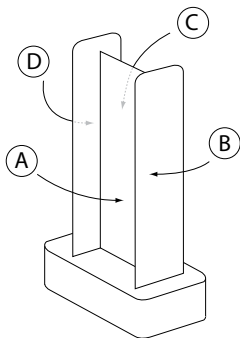
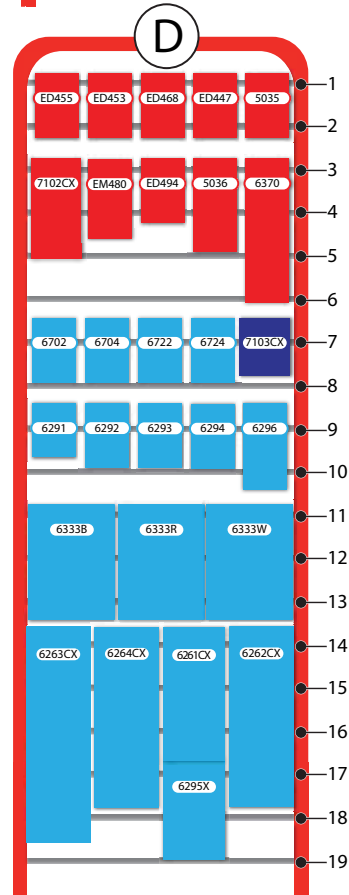

MKT-POP-DEVCOMBO Merchandising Rack
72" x 22" x 20.5"

NOTE: Item numbers in **RED** indicate Made in the U.S.A.



DEVCO RACKS MASTER ITEM LIST (BY RACK)

This DEVCO product list includes any DEVCO item that is part of the plan-o-gram display for either the EZC, ELEC or COMBO versions of the DEVCO rack. This cross reference indicates on which display rack each item should be placed.

ITEM #	ITEM DESCRIPTION	ELEC	EZC	COMBO
5002	Crimp Tool w/ Cutter & Stripper Ins.		X	X
5031	Test Leads (ins. Alligator clips) Low Voltage 22in 8pcs	X	X	
5033	Alligator Clips (steel) 2in long for probes .075in-.08in	X		
5035	Alligator Clips (copper) B&R Ins 2in long	X		X
5036	Test Clip (steel 20A) B&R Insulators 2-7/16in long	X		X
5041	Test Leads Low Voltage Hook Ty22ga 36in red & black	X		
5223	Triple Outlet 2 Pole 3 Wire 15A-125V Polarized plastic	X		
5381	Nylon Cable Clamp 1/8in I.D.		X	
5382	Nylon Cable Clamp 1/4in I.D.		X	X
5383	Nylon Cable Clamp 3/8in I.D.		X	
5384	Nylon Cable Clamp 1/2in I.D.		X	X
6900AX	Self-Drilling Screw Repair Kit		X	
6101	Motor Shaft Keys (1/8in 3/16in 1/4in 3/16in x 1/4in) zn Pltd.		X	
6102	Motor Shaft Keys (1/4insq 5/16insq 3/8insq) zn Pltd.		X	
6183	Terminal Block 20A-250V 6 pos			X
6185	Terminal Block 20A-250V 10 pos			X
6187	Terminal Block 20A-250V 14 pos			X
6211	Tab Ad. S. F Dbl M. .250 Non-Ins.			X
6212	Dbl. M. Tab Ad. . S. F . Non-Ins.			X
6216	Ring 16-14 Ins. #10 Stud			X
6218	Slip-on F 16-14 Ins. .250		X	X
6219	Slip-on M 16-14 Ins. .250		X	X
6224	Flag F QD 12-10 Non-Ins. .250		X	X
6229	Slip-on F 16-14 Full Ins. .250		X	
6235	Slip-on F 22-18 Ins. .250		X	X
6237	Spade 22-18 Ins. #8 Stud		X	X
6249	M Tab 1 pair bent 90 Non-Ins.			X
6251	Slip-on F 12-10 Ins. .250		X	X
6252	Ring 12-10 Ins. #10 Stud		X	X
6253	Ring 12-10 Ins. 1/4in Stud		X	X
6255	Spade 12-10 Ins. #10 Stud		X	X
6258	Comp. Flag F. 16-14 Non-Ins. .250		X	X
6259	Comp. Flag F. 12-10 Non-Ins. .250			X
6269	Cable Tie Mount		X	
6270	Comp. Flag F. 12-8 Non-Ins. .250		X	X
6272	Ring 16-14 Ins. #6 Stud			X
6274	Spade 16-14 Ins. #6 Stud		X	
6276	Spr. Spade 16-14 Ins. #6 Stud		X	X
6281	Slip-on F 16-14 Ins. .187		X	X
6282	Slip-on F 22-18 Ins. .187		X	
6291	Wire Connector Mini-Gray		X	X
6292	Wire Connector Tiny-Blue		X	X
6293	Wire Connector Small-Orange		X	X
6294	Wire Connector Medium-Yellow		X	X
6296	Wire Connector Large-Red		X	X
6298	Wire Connector XLarge-Gray		X	
6336	Thermostat Wire 3 Conduct.40 ft.	X		
6337	Thermostat Wire 5 Conduct.40 ft.	X		
6341	SJTO Service Cord 16 GA 20 ft.	X	X	
6343	SJTO Service Cord 14 GA 20 ft.	X	X	
6370	Heat Shrink Tubing Assort. B&W 1/8in & 1/4in supplied 6in	X		X
6413	Fin. Hex Nut 1/4in-20 zn Pltd.			X
6501	Fin. Hex Nut 1/4in-20 zn Pltd.		X	X
6503	Fin. Hex Nut 3/8in-16 zn Pltd.		X	X
6642	HH Cap Screw 3/8in-16 x 1in		X	
6643	HH Cap Screw 3/8in-16 x1 1/2in		X	
6701	Flat Washer 3/16in Uss zn Pltd.		X	
6702	Flat Washer 1/4in Uss zn Pltd.		X	X

ITEM #	ITEM DESCRIPTION	ELEC	EZC	COMBO
6703	Flat Washer 5/16in Uss zn Pltd.		X	
6704	Flat Washer 3/8in Uss zn Pltd.		X	X
6706	Flat Washer 1/2in Uss zn Pltd.		X	
6722	Fender Washer 1/4in zn Pltd.		X	X
6724	Fender Washer 3/8in zn Pltd.		X	X
7033	Toggle Bolt w/wing 3/16inx4inzn Pltd.		X	
7034	Toggle Bolt w/wing 1/4inx4in zn Pltd.		X	
60210	Tab Ad. Ins. .250 16-14 multi stack male & female		X	X
60251	Slip-On F 12-10 Non-Ins. .250		X	X
60259HX	Comp. Lead Kt 12in 10ga wire		X	X
60264CX	Cable Tie 6in w/ #8 Hole 30# 1-3/8in B. Dia nat 100/PK		X	
60265LX	Cable Tie 14in 50# 4in B. Dia natural 50 pcs		X	
61233LX	Slip-on M & F 16-14 .250 Full Ins Nylon 50 pcs		X	X
6211CX	Tab Ad. S. F Dbl M Non-Ins.100 pcs		X	X
6213CX	Flag F QD 16-14 Non-Ins. .250 100 pcs		X	X
6214CX	Slip-on F 16-14 Non-Ins. .250 100 pcs		X	X
6216LX	Ring 16-14 Ins. #10 Stud 50 pcs		X	X
6217CX	Butt Conn. 16-14 Ins. 100 pcs		X	X
6217LX	Butt Conn. 16-14 Ins. 50 pcs		X	X
6218LX	Slip-on F 16-14 Ins. .250 50 pcs		X	X
6222LX	Dead End Conn. 22-14 Fully Ins. 50 pcs		X	X
6223LX	Dead End Conn. 18-10 Fully Ins. 50 pcs		X	X
6227LX	Spade 16-14 Ins. #8 Stud		X	X
6228LX	Spade 16-14 Ins. #10 Stud 50 pcs		X	X
6229LX	Slip-on F 16-14 Full Ins. .250		X	X
6231LX	Butt Conn. 12-10 Ins. 50 pcs		X	X
6232LX	Butt Conn. 22-18 Ins. 50 pcs		X	X
6233LX	Slip-on F 16-14 .250 Full Ins. Nylon 50 pcs		X	X
6234LX	Slip-on M 16-14 .250 Full Ins. Nylon 50 pcs		X	X
6235LX	Slip-on F 22-18 Ins. .250 50 pcs		X	X
6236LX	Ring 22-18 Ins. #8 Stud 50 pcs		X	X
6239LX	Spr. Spade 16-14 Ins. #8 Stud		X	X
6251LX	Slip-on F 12-10 Ins. .250		X	X
6252LX	Ring 12-10 Ins. #10 Stud		X	X
6255LX	Spade 12-10 Ins. #10 Stud 50 pcs		X	X
6257NX	Ring #8 Ins. 1/4in Stud 25 pc		X	X
6258CX	Comp. Flag F. 16-14 Non-Ins. .250 100 pcs		X	X
6259CX	Comp. Flag F. 12-10 Non-Ins. .250 100 pcs		X	X
6261CX	Cable Tie 6in 18# 1-3/8in B. Dia natural 100 pcs		X	X
6262CX	Cable Tie 7-1/2in 50# 1-3/4in B. Dia natural 100 pcs		X	X
6263CX	Cable Tie 11in 50# 3in B. Dia natural 100 pcs		X	X
6263BCX	Cable Tie 11in 50# 3in B. Dia black 100 pcs		X	
6264CX	Cable Tie 7in w/ #10 Hole 50# 1-3/4in B. Dia nat 100/PK		X	X
6269LX	Cable Tie Mount 50 pcs		X	
6270LX	Comp. Flag F. 12-8 Non-Ins. .250 50 pcs		X	X
6277NX	Flag F QD 16-14 .250 Fully Ins. Nylon 25 pcs		X	X
6281LX	Slip-on F 16-14 Ins. .187 50 pcs		X	X
6289LX	Bullet Plug & Rec. 16-14 Ins. 50 pcs		X	X
6295X	Assorted Wire Connectors		X	X
6310X	Grease Fitting Assortment box		X	
6332B	Hook-up Wire 16ga blk. 48 ft	X		
6332R	Hook-up Wire 16ga red. 48 ft	X		
6332W	Hook-up Wire 16ga wht. 48 ft	X		
6333B	Hook-up Wire 14ga blk. 48 ft			X
6333G	Hook-up Wire 14ga grn. 48 ft			
6333R	Hook-up Wire 14ga red. 48 ft			X
6333W	Hook-up Wire 14ga wht. 48 ft			X
6334B	Hook-up Wire 12ga blk. 48 ft			X

continued

DEVCO RACKS MASTER ITEM LIST (BY RACK) cont'd

ITEM #	ITEM DESCRIPTION	ELEC	EZC	COMBO
6334R	Hook-up Wire 12ga red 48 ft	X		X
6334W	Hook-up Wire 12ga wht. 48 ft			X
6335B	Hook-up Wire 10ga blk. 48 ft	X		X
6335R	Hook-up Wire 10ga red 48 ft	X		X
6335W	Hook-up Wire 10ga wht. 48 ft	X		X
6500A	Asst Mach. Screw Hex Nuts 6-32 8-32 10-32 zn Pltd.			X
6503CX	Fin. Hex Nut 3/8in-16 zn Pltd. 100 pcs		X	
6700AX	Flat Washer Assortment Pack 3/16 1/4 5/16 3/8 1/2 5/8 inch		X	
6943CX	Self Drilling Screw #8x1/2in 1/4in Hex Head zn Pltd. 100/PK		X	X
6945CX	Self Drilling Screw #8x3/4in 1/4in Hex Head zn Pltd. 100/PK		X	X
6946CX	Self Drilling Screw #8x1in 1/4in Hex Head zn Pltd. 100/PK		X	X
6953CX	Drill Tip Screw #10x1/2in 5/16in Hex Head 100/PK		X	X
6955CX	Drill Tip Screw #10x3/4in 5/16in Hex Head 100/PK		X	X
6956CX	Self Drilling Screw #10x1in 5/16in Hex Head zn Pltd. 100/PK		X	X
7036X	Toggle Bolt w/wing 3/8inx4in zn Pltd.		X	
7101CX	Anch Kit Yellow #8x1in w 3/16in bit 100 s + 100 a		X	X
7102CX	Anch Kit Red #10x1-1/4in w 1/4in bit 100 s + 100 a		X	X
7103CX	Anch Kit Blue #4x3/4in w 5/32in bit 100 s + 100 a		X	X
7106CX	Plug Anchor Kit Green #10x1in 1/4in bit 100 s + 100 a bag		X	
7111CX	Plug Anchor Kit Blue #14x1in w 5/16in bit 100 s + 100 a bag		X	
DE13	Magnetic Hex Chuck 1/4in x 1-3/4in		X	
DE14	Magnetic Hex Chuck 5/16in x 1-3/4in		X	
DE15	Magnetic Hex Chuck 3/8in x 1-7/8 in		X	
DE23	Magnetic Hex Chuck 1/4in x 2-9/16 in		X	
ED1232	Toggle Switch D.P. 30A-120/277V brown			X
ED1238	Toggle Switch S.P. 20A-120/277V brown			X
ED1240-2	Toggle Switch S.P. 15A-120/277V brown	X		
ED1262-2	Toggle Switch D.P. 15A-120/277V brown			X
ED1301	Toggle Switch S.P. 15A-120V brown	X		X
ED1876	Single Receptacle 20A-250V 2 pl. 3 wr. brown	X		
ED1876-I	Single Receptacle 20A-250V 2 pl. 3 wr. ivory	X		
ED270	Duplex Receptacle 15A-125V 2 pl. 3 wr. brown			X
ED270-I	Duplex Receptacle 15A-125V 2 pl. 3 wr. ivory	X		
ED273CX	Electrical Staple insul size #5 5/8in x 1/4in 100/PK	X		X
ED2867	Armored Plug 15A-125V 2pl. 3 wr. vinyl enclosed			X
ED2887	Armored Connector 15A-125V 2pl. 3 wr. vinyl enclosed			X
ED320	Vinyl Grommet Asst. contains: ED300 thru ED316	X	X	X
ED447	Bat Handle Switch metal SPST on-off 10A/277V-20A/125V AC	X		X
ED453	Bat Handle Switch metal DPDT on-on 10A/277V-20A/125V AC	X		X
ED454	Bat Handle Switch metal SPDT on-on 10A/277V-20A/125V AC	X		
ED455	Bat Handle Switch metal DPST on-off 10A/277V-20A/125V AC	X		X
ED468	Bat Handle Switch metal SPDT on-off-on 10A/277V-20A/125V	X		X
ED494	Bat Handle Switch metal DPDT on-off-on 10A/277V-20A/125V	X		X
ED5225	Switch & Receptacle 2p 3w (sw:15A-120VAC& rec:15A-125VAC) brn	X		
ED600	Indicator Light 28V red PC lens incandescent bulb	X		
ED601	Indicator Light 28V green PC lens incandescent bulb	X		
ED602	Indicator Light 28V amber PC lens incandescent bulb	X		
ED610	Indicator Light 105-125V AC red nylon lens neon bulb	X		
ED611	Indicator Light 105-125V AC grn PC lensneon blb-G2B Imp&resstr	X		
ED877	Duplex Receptacle 20A-125V 2 pl. 3 wr. brown			X
EM480	In-Line Fuse Holder 1-1/4 x 1/4in fuses to 20A/32V 14ga	X		X
ED-AT3	Blade Fuses - 3 Amp - Purple, Pack of 10	X	X	X
ED-AT5	Blade Fuses - 5 Amp - Tan, Pack of 10	X	X	X
ED-CR15	Dual Element Fuses - 15 Amp, Pack of 2	X		X
ED-CR20	Dual Element Fuses - 20 Amp, Pack of 2	X		X
ED-CR25	Dual Element Fuses - 25 Amp, Pack of 2	X		X
ED-CR30	Dual Element Fuses - 30 Amp, Pack of 2	X	X	X
ED-CR35	Dual Element Fuses - 35 Amp, Pack of 2	X		X
ED-CR40	Dual Element Fuses - 40 Amp, Pack of 2	X		X
ED-CR45	Dual Element Fuses - 45 Amp, Pack of 2	X		X

ITEM #	ITEM DESCRIPTION	ELEC	EZC	COMBO
ED-CR50	Dual Element Fuses - 50 Amp, Pack of 2	X		X
ED-CR60	Dual Element Fuses - 60 Amp, Pack of 2	X	X	X
HC5410	Hose Clamp 9/16in-1-1/8in SShousing&band st hex screw		X	X
HC5416	Hose Clamp 3/4in-1-1/2in SShousing&band st hex screw		X	
HC6202	Hose Clamp 1/4in-5/8in SS housing&band st hex screw		X	X
HC6203	Hose Clamp 5/16in-7/8in SShousing&band st hex screw		X	X
PI301	Cond Nip 1/2in offset zn w pltd. stl locknuts insul. bushings			X
PI303	Cond Nip 1/2in strt galv steel w pltd. stl lock insul.			X
PI310	Reduc. Wash 3/4in to 1/2in Rsd Fln Galv St			X
PI312	BX Conct set screw 3/8in Tr. 1/2in KO. zn die cast			X
PI315	BX Connector 90 3/8inTr. 1/2in KO zn die cast	X	X	X
PI316	Knockout Seal for 1/2in KO zn Pltd. steel	X		
PI319	Romex Connector 3/4in Tr. 3/4in KO. zn Pltd. die cast	X		
PI320	Romex Connector 3/8in Tr. 1/2in KO. zn Pltd. die cast 25/PK	X	X	X
PI321	Romex Connector 3/8in Tr. 1/2 in KO. zn Pltd. die cast	X	X	X
PI322	BX Conct str saze 3/8in Tr. 1/2in KO. zn die cast	X		
PI328	Split Bolt Connector Cu use (6 max sol & 7 max strnd)			X
PI330	Romex Stop plastic 3/8inx1/2in for 2 cond. romex 12/2-14/2	X		
PI331	Plastic in Anti-Shortin Bush 14/2 14/3 & 12/2 BX cable	X		
PI340	Combo Cable Connector for romex & BX 3/8in Tr. 1/2in KO	X		
PI350	Metal LT Conn straight 1/2in Tr. 1/2in K.O	X		
PI351	Metal LT Conn straight 3/4in Tr. 3/4in K.O.	X		
PI352	Liquid Tight Connector 90 1/2in Tr. 1/2in K.O. zn die cast	X		
PI353	Liquid Tight Connector 90 3/4in Tr. 3/4in K.O. zn die cast	X		
PI360	Box galv. steel 4in x 2-1/8inx 1-7/8in 1/2in KO 13 in ³	X		X
PI361	Box galv. steel 4in x 2-1/8inx 2-1/8in 1/2in KO 14.5 in ³	X		X
PI362	1900 Box galv. steel 4X4X1-1/2 1/2&3/4 KO 21 in ³	X		X
PI363	1900 Box galv. steel 4X4X2-1/8in 1/2&3/4 KO 30.3 in ³	X		X
PI365	Utility Cover Toggle Switch 2-11/32in x 4-1/4in Pltd. steel	X		
PI368	1900 Cover Sw/Dup Rec cad fin. steel 4in x 4in raisd 1/2in	X		X
PI371	1900 Cover Blank Flat galv. steel	X		X
PI378	1900 Cover Duplex Recep cadil fin. steel 4X4 raisd 1/2in	X		
PI381	Fuse Outlet & Switch w cover 1/2HP-125V AC galv. steel			X
PI382	Weatherproof Cover Blank Al 1 Gang w gasket anodized	X		
PI385	Wthprf Box AL2-3/4inx4-1/2inx23 1/2in holes 2 plugs 19in ³	X		
WM1002	Cable Marker Book alpha numer	X		
WM1003	Cable Marker Book numeric contains 10 each: 1 - 45	X	X	
WM1009	Cable Marker Book line & term	X		



D
E
V
C
O

SLIP-ON SOLDERLESS TERMINALS

Insulated Male Slip-Ons

These male terminals crimp to the wires which relieves the need to solder. A variety of sizes are available and the slip ons are fully insulated in either vinyl or nylon.



CATALOG NO.	DESCRIPTION	WIRE RANGE	TAB SIZE	UOM	ORDER MULTIPLE
60219	Insulated Male Slip-On, pack of 23	22-18	.250	PK	1
60220	Insulated Male Slip-On, pack of 23	16-14	.187	PK	1
60220LX	Insulated Male Slip-On, pack of 50	16-14	.187	PK	1
6219	Insulated Male Slip-On, pack of 22	16-14	.250	PK	1
6219LX	Insulated Male Slip-On, pack of 50	16-14	.250	PK	1
61221LX	Insulated Male Slip-On, pack of 50	12-10	.250	PK	1
61221CX	Insulated Male Slip-On, pack of 100	12-10	.250	PK	1

Insulated Female Slip-Ons

These female terminals crimp to the wires which relieves the need to solder. A variety of sizes are available and the slip ons are fully insulated in either vinyl or nylon.



CATALOG NO.	DESCRIPTION	WIRE RANGE	TAB SIZE	UOM	ORDER MULTIPLE
6282	Insulated Female Slip-On, pack of 22	22-18	.187	PK	1
6282LX	Insulated Female Slip-On, pack of 50	22-18	.187	PK	1
6235	Insulated Female Slip-On, pack of 22	22-18	.250	PK	1
6235LX	Insulated Female Slip-On, pack of 50	22-18	.250	PK	1
6235CX	Insulated Female Slip-On, pack of 100	22-18	.250	PK	1
6281	Insulated Female Slip-On, pack of 22	16-14	.187	PK	1
6281LX	Insulated Female Slip-On, pack of 50	16-14	.187	PK	1
6218	Insulated Female Slip-On, pack of 22	16-14	.250	PK	1
6218LX	Insulated Female Slip-On, pack of 50	16-14	.250	PK	1
6218CX	Insulated Female Slip-On, pack of 100	16-14	.250	PK	1
6251	Insulated Female Slip-On, pack of 17	12-10	.250	PK	1
6251LX	Insulated Female Slip-On, pack of 50	12-10	.250	PK	1
6251CX	Insulated Female Slip-On, pack of 100	12-10	.250	PK	1
61223LX	Insulated Female Slip-On, pack of 50	12-10	.340	PK	1

Fully Insulated Female Slip-Ons

These female terminals crimp to the wires which relieves the need to solder. A variety of sizes are available and the slip ons are fully insulated in either vinyl or nylon. This terminal features insulation grip. This terminal is usually supplied vinyl and has an insulation grip.



CATALOG NO.	DESCRIPTION	WIRE RANGE	TAB SIZE	UOM	ORDER MULTIPLE
6229**	Fully Insulated Female Slip-On, pack of 11	16-14	.250	PK	1
6229LX**	Fully Insulated Female Slip-On, pack of 50	16-14	.250	PK	1
6233	Fully Insulated Female Slip-On, pack of 14	16-14	.250	PK	1
6233LX	Fully Insulated Female Slip-On, pack of 50	16-14	.250	PK	1
61234LX	Fully Insulated Female Slip-On, pack of 50	12-10	.250	PK	1

* This terminal features insulation grip.
** This terminal is usually supplied vinyl and has an insulation grip.

Non-Insulated Male Slip-Ons

These non insulated male terminals crimp to the wires which relieves the need to solder. A variety of sizes are available



CATALOG NO.	DESCRIPTION	WIRE RANGE	TAB SIZE	UOM	ORDER MULTIPLE
6220	Non-Insulated Male Slip-On, pack of 38	16-14	.250	PK	1
6220CX	Non-Insulated Male Slip-On, pack of 100	16-14	.250	PK	1
61220	Non-Insulated Male Slip-On, pack of 37	16-14	.250	PK	1

Non-Insulated Female Slip-Ons

These non insulated female terminals crimp to the wires which relieves the need to solder. A variety of sizes are available. This terminal features insulation grip.



CATALOG NO.	DESCRIPTION	WIRE RANGE	TAB SIZE	UOM	ORDER MULTIPLE
6214	Non-Insulated Female Slip-On, pack of 35	16-14	.250	PK	1
6214CX	Non-Insulated Female Slip-On, pack of 100	16-14	.250	PK	1
60251	Non-Insulated Female Slip-On, pack of 26	12-10	.250	PK	1
60251CX	Non-Insulated Female Slip-On, pack of 100	12-10	.250	PK	1

* This terminal features insulation grip.

Fully Insulated Male Slip-Ons

These male terminals crimp to the wires which relieves the need to solder. A variety of sizes are available and the slip ons are fully insulated in either vinyl or nylon.



CATALOG NO.	DESCRIPTION	WIRE RANGE	TAB SIZE	UOM	ORDER MULTIPLE
6234	Fully Insulated Male Slip-On, pack of 14	16-14	.250	PK	1
6234LX	Fully Insulated Male Slip-On, pack of 50	16-14	.250	PK	1
61235LX	Fully Insulated Male Slip-On, pack of 50	12-10	.250	PK	1

Non-Insulated Flag Female Slip-Ons

These non insulated female terminals crimp to the wires which relieves the need to solder. A variety of sizes are available. Part 6213 features insulation grip.



CATALOG NO.	DESCRIPTION	WIRE RANGE	TAB SIZE	UOM	ORDER MULTIPLE
6213	Non-Insulated Flag Female Slip-On, pack of 34	16-14	.250	PK	1
6213CX	Non-Insulated Flag Female Slip-On, pack of 100	16-14	.250	PK	1
6224	Non-Insulated Flag Female Slip-On, pack of 20	12-10	.250	PK	1
6224CX	Non-Insulated Flag Female Slip-On, pack of 100	12-10	.250	PK	1



SLIP-ON SOLDERLESS TERMINALS cont'd

Fully Insulated Flag Female Slip-Ons

These female terminals crimp to the wires which relieves the need to solder. A variety of sizes are available and the slip ons are fully insulated in either vinyl or nylon.

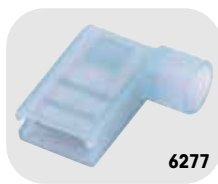

CATALOG NO.	DESCRIPTION	WIRE RANGE	TAB SIZE	UOM	ORDER MULTIPLE
6277	Fully Insulated Flag Female Slip-On, pack of 9	16-14	.250	PK	1
6277NX	Fully Insulated Flag Female Slip-On, pack of 25	16-14	.250	PK	1

Combination Pack: Set of 6233 and 6234

Our Combination pack holds both a Fully Insulated Male and Female Slip On.



CATALOG NO.	DESCRIPTION	WIRE RANGE	TAB SIZE	UOM	ORDER MULTIPLE
61233LX	Set of Fully Insulated M/F Slip-Ons, pack of 25 pairs	16-14	.250	PK	1

Flag Female Compressor Terminal Kit

Parts 6258, 6271, 6259, 6273, 6270 in a four compartment, clear plastic box. Parts 6270 and 6273 are put in the same compartment.



CATALOG NO.	DESCRIPTION	UOM	ORDER MULTIPLE
6200HX	Flag Female Compressor Terminal Kit	EA	1

Flag Female Compressor Terminals

Also known as hermetic header terminals, these non-insulated terminals are designed with a larger distance between the "rolls" to allow for the rod in hermetic header applications. The increased distance allows the rod to slip in between them. Parts 6258 and 6259 are notched for bending. The notches are cut between the slip-on portion and the conductor barrel and enable the back of the slip-on portion to be folded against the conductor barrel after the wire connection is made. This terminal features insulation grip.



CATALOG NO.	DESCRIPTION	WIRE RANGE	FITS	UOM	ORDER MULTIPLE
6270	Flag Female Compressor Terminal, pack of 9	12-8	.250 tab	PK	1
6270LX	Flag Female Compressor Terminal, pack of 50	12-8	.250 tab	PK	1
6258*	Flag Female Compressor Terminal, pack of 17	16-14	.250 tab	PK	1
6258CX*	Flag Female Compressor Terminal, pack of 100	16-14	.250 tab	PK	1
6259	Flag Female Compressor Terminal, pack of 14	12-10	.250 tab	PK	1
6259CX	Flag Female Compressor Terminal, pack of 100	12-10	.250 tab	PK	1

*This terminal features insulation grip.

Compressor Lead Kit

Our Compressor Lead kit includes the following products: a flag female compressor terminal (.250 tab; part 62589), a waterproof butt connector (12 10 wire range; part 62231), and a piece of 10 gauge wire.



CATALOG NO.	DESCRIPTION	UOM	ORDER MULTIPLE
60259HX	Compressor Lead Kit with 12" wire	EA	1

SPECIAL PURPOSE SOLDERLESS TERMINALS

Insulated Plugs

These insulated terminals crimp to the wires which relieves the need to solder.



CATALOG NO.	DESCRIPTION	WIRE RANGE	UOM	ORDER MULTIPLE
6283LX	Insulated Plugs, pack of 50	22-18	PK	1
6285	Insulated Plugs, pack of 17	16-14	PK	1
6285LX	Insulated Plugs, pack of 50	16-14	PK	1

Combination Packs

These insulated terminals crimp to the wires which relieves the need to solder.



CATALOG NO.	DESCRIPTION	UOM	ORDER MULTIPLE
6288	Combination Pack with parts 6283 and 6284, pack of 7 pairs	PK	1
6288LX	Combination Pack with parts 6283 and 6284, pack of 25 pairs	PK	1
6289	Combination Pack with parts 6285 and 6286, pack of 7 pairs	PK	1
6289LX	Combination Pack with parts 6285 and 6286, pack of 25 pairs	PK	1

Fully Insulated Receptacles

These insulated terminals crimp to the wires which relieves the need to solder.

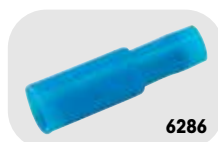

CATALOG NO.	DESCRIPTION	WIRE RANGE	UOM	ORDER MULTIPLE
6286	Fully Insulated Receptacles, pack of 12	16-14	PK	1

SPECIAL PURPOSE SOLDERLESS TERMINALS cont'd

Tab Adapters – Quick Disconnect with Screw

These insulated terminals crimp to the wires which relieves the need to solder.



CATALOG NO.	DESCRIPTION	UOM	ORDER MULTIPLE
6209	Fits .250 Tab, #6-32 x 1/4" Screw, pack of 5	PK	1
6209LX	Fits .250 Tab, #6-32 x 1/4" Screw, pack of 50	PK	1

Tab Adapters – Single Female Double Male Tabs

These insulated terminals crimp to the wires which relieves the need to solder. .250 male, .250 female.



CATALOG NO.	DESCRIPTION	TAB SIZE	UOM	ORDER MULTIPLE
6208	Tab Adapter; 1 female, 2 male; Bent 90°, pack of 12	.250	PK	1
6208LX	Tab Adapter; 1 female, 2 male; Bent 90°, pack of 50	.250	PK	1
6211	Tab Adapter; 1 female, 2 male; Wye, pack of 27	.250	PK	1
6211CX	Tab Adapter; 1 female, 2 male; Wye, pack of 100	.250	PK	1
6212	Tab Adapter; 1 female, 2 male; Stacked, pack of 16	.250	PK	1
6212CX	Tab Adapter; 1 female, 2 male; Stacked, pack of 100	.250	PK	1

Tap Connectors

These insulated terminals crimp to the wires which relieves the need to solder. Designed to make tap splices.



CATALOG NO.	DESCRIPTION	WIRE RANGE	UOM	ORDER MULTIPLE
6241	Tap Splice – blue, pack of 15	16-14	PK	1

Tab Adapters – Piggy Back Slip-Ons

These insulated terminals crimp to the wires which relieves the need to solder. Multi-stack, .250 male tab, .250 female slip-on.



CATALOG NO.	DESCRIPTION	WIRE RANGE	UOM	ORDER MULTIPLE
6210	Non-Insulated Piggy Back Slip-Ons, pack of 20	16-14	PK	1
60210	Insulated Piggy Back Slip-Ons, pack of 11	16-14	PK	1
60210LX	Insulated Piggy Back Slip-Ons, pack of 50	16-14	PK	1
60210CX	Insulated Piggy Back Slip-Ons, pack of 100	16-14	PK	1

Tab Adapters – Male Tabs

These insulated terminals crimp to the wires which relieves the need to solder.

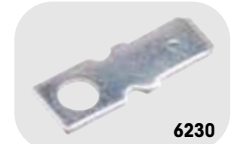

CATALOG NO.	DESCRIPTION	TAB SIZE	STUD	UOM	ORDER MULTIPLE
6230	Male Tabs – Straight, pack of 28	.250	#8	PK	1
6230CX	Male Tabs – Straight, pack of 100	.250	#8	PK	1

Fully Insulated Dead End Connectors

These insulated terminals crimp to the wires which relieves the need to solder.



CATALOG NO.	DESCRIPTION	WIRE RANGE	UOM	ORDER MULTIPLE
6222	Fully Insulated Dead End Connectors, pack of 27	22-14	PK	1
6222LX	Fully Insulated Dead End Connectors, pack of 50	22-14	PK	1
6223	Fully Insulated Dead End Connectors, pack of 21	18-10	PK	1
6223LX	Fully Insulated Dead End Connectors, pack of 50	18-10	PK	1

STANDARD SOLDERLESS TERMINALS

Insulated Hooks

These insulated terminals crimp to the wires which relieves the need to solder.



CATALOG NO.	DESCRIPTION	WIRE RANGE	STUD	UOM	ORDER MULTIPLE
6242	Insulated Hooks, pack of 22	22-18	#8	PK	1
6242LX	Insulated Hooks, pack of 50	22-18	#8	PK	1
6244	Insulated Hooks, pack of 20	16-14	#8	PK	1
6244LX	Insulated Hooks, pack of 50	16-14	#8	PK	1

Insulated Butt Connectors

These insulated terminals crimp to the wires which relieves the need to solder.



CATALOG NO.	DESCRIPTION	WIRE RANGE	UOM	ORDER MULTIPLE
6232	Insulated Butt Connector, pack of 26	22-18	PK	1
6232LX	Insulated Butt Connector, pack of 50	22-18	PK	1
6232CX	Insulated Butt Connector, pack of 100	22-18	PK	1
6217	Insulated Butt Connector, pack of 27	16-14	PK	1
6217LX	Insulated Butt Connector, pack of 50	16-14	PK	1
6217CX	Insulated Butt Connector, pack of 100	16-14	PK	1
6231	Insulated Butt Connector, pack of 16	12-10	PK	1
6231LX	Insulated Butt Connector, pack of 50	12-10	PK	1
6231CX	Insulated Butt Connector, pack of 100	12-10	PK	1
6287XX	Insulated Butt Connector, pack of 10	8	PK	1
6287CX	Insulated Butt Connector, pack of 100	8	PK	1



STANDARD SOLDERLESS TERMINALS cont'd

Butt Connector Assortment Kit

This Assortment is a perfect addition to the HVAC kit. It includes an Insulated Butt Connector, a Non Insulated Butt Connector, and a Nylon Insulated Butt Connector. Includes parts 6217, 6231, and 6232.



CATALOG NO.	DESCRIPTION	UOM	ORDER MULTIPLE
6200BSX	Butt Connector Assortment Kit	EA	1

Insulated Spades

These insulated terminals crimp to the wires which relieves the need to solder.



CATALOG NO.	DESCRIPTION	WIRE RANGE	STUD	UOM	ORDER MULTIPLE
61214	Insulated Spades, pack of 23	22-18	#6	PK	1
6237	Insulated Spades, pack of 22	22-18	#8	PK	1
6237LX	Insulated Spades, pack of 50	22-18	#8	PK	1
61256LX	Insulated Spades, pack of 50	22-18	#10	PK	1
6274	Insulated Spades, pack of 22	16-14	#6	PK	1
6274LX	Insulated Spades, pack of 50	16-14	#6	PK	1
6227	Insulated Spades, pack of 22	16-14	#8	PK	1
6227LX	Insulated Spades, pack of 50	16-14	#8	PK	1
6228	Insulated Spades, pack of 22	16-14	#10	PK	1
6228LX	Insulated Spades, pack of 50	16-14	#10	PK	1
60254	Insulated Spades, pack of 18	12-10	#8	PK	1
60254LX	Insulated Spades, pack of 50	12-10	#8	PK	1
60254CX	Insulated Spades, pack of 100	12-10	#8	PK	1
6255	Insulated Spades, pack of 17	12-10	#10	PK	1
6255LX	Insulated Spades, pack of 50	12-10	#10	PK	1
6255CX	Insulated Spades, pack of 100	12-10	#10	PK	1

Non-Insulated Rings

These non insulated terminals crimp to the wires which relieves the need to solder.



CATALOG NO.	DESCRIPTION	WIRE RANGE	STUD	UOM	ORDER MULTIPLE
6215	Non-Insulated Rings, pack of 27	16-14	#8	PK	1

Non-Insulated Spades

These non insulated terminals crimp to the wires which relieves the need to solder.



CATALOG NO.	DESCRIPTION	WIRE RANGE	STUD	UOM	ORDER MULTIPLE
6226CX	Non-Insulated Spades, pack of 100	16-14	#10	PK	1

Insulated Spring Spades

These insulated terminals crimp to the wires which relieves the need to solder.



CATALOG NO.	DESCRIPTION	WIRE RANGE	STUD	UOM	ORDER MULTIPLE
6238	Insulated Spring Spades, pack of 22	22-18	#8	PK	1
6238LX	Insulated Spring Spades, pack of 50	22-18	#8	PK	1
6276	Insulated Spring Spades, pack of 21	16-14	#6	PK	1
6276LX	Insulated Spring Spades, pack of 50	16-14	#6	PK	1
6239	Insulated Spring Spades, pack of 22	16-14	#8	PK	1
6239LX	Insulated Spring Spades, pack of 50	16-14	#8	PK	1
60256CX	Insulated Spring Spades, pack of 100	12-10	#8	PK	1

Insulated Rings

These insulated terminals crimp to the wires which relieves the need to solder.



CATALOG NO.	DESCRIPTION	WIRE RANGE	STUD	UOM	ORDER MULTIPLE
61202	Insulated Rings, pack of 22	22-18	#6	PK	1
6236LX	Insulated Rings, pack of 50	22-18	#8	PK	1
6272	Insulated Rings, pack of 22	16-14	#6	PK	1
6216	Insulated Rings, pack of 23	16-14	#10	PK	1
6216LX	Insulated Rings, pack of 50	16-14	#10	PK	1
6216CX	Insulated Rings, pack of 100	16-14	#10	PK	1
60247	Insulated Rings, pack of 17	12-10	#6	PK	1
60252CX	Insulated Rings, pack of 100	12-10	#8	PK	1
6252	Insulated Rings, pack of 17	12-10	#10	PK	1
6252LX	Insulated Rings, pack of 50	12-10	#10	PK	1
6253LX	Insulated Rings, pack of 50	12-10	1/4"	PK	1
6253CX	Insulated Rings, pack of 100	12-10	1/4"	PK	1
6257	Insulated Rings, pack of 6	8	1/4"	PK	1
6257NX	Insulated Rings, pack of 25	8	1/4"	PK	1
61252NX	Insulated Rings, pack of 25	6	5/16"	PK	1

HIGH TEMPERATURE SOLDERLESS TERMINALS

High Temperature Male Slip-Ons

The High Temperature Male Slip Ons are constructed of nickel plated steel. These non insulated terminals are rated at 900 degree F (482 degree C).



4220

CATALOG NO.	DESCRIPTION	WIRE RANGE	TAB SIZE	UOM	ORDER MULTIPLE
4220	High Temp. Male Slip-Ons, pack of 21	16-14	.250	PK	1
4220CX	High Temp. Male Slip-Ons, pack of 100	16-14	.250	PK	1

High Temperature Flag Female Slip-Ons

The High Temperature Flag Female Slip Ons are constructed of nickel plated steel. These non insulated terminals are rated at 900 degree F (482 degree C).



4213

CATALOG NO.	DESCRIPTION	WIRE RANGE	TAB SIZE	UOM	ORDER MULTIPLE
4213	High Temp. Flag Female Slip-Ons, pack of 16	16-14	.250	PK	1
4213CX	High Temp. Flag Female Slip-Ons, pack of 100	16-14	.250	PK	1
4224	High Temp. Flag Female Slip-Ons, pack of 11	12-10	.250	PK	1
4224NX	High Temp. Flag Female Slip-Ons, pack of 25	12-10	.250	PK	1
4224CX	High Temp. Flag Female Slip-Ons, pack of 100	12-10	.250	PK	1

High Temperature Rings

The High Temperature Rings are constructed of nickel plated steel. These non insulated terminals are rated at 900 degree F (482 degree C).



4252

CATALOG NO.	DESCRIPTION	WIRE RANGE	STUD	UOM	ORDER MULTIPLE
4215	High Temp. Rings, pack of 21	16-14	#10	PK	1
4215CX	High Temp. Rings, pack of 100	16-14	#10	PK	1
4205CX	High Temp. Rings, pack of 100	16-14	1/4"	PK	1
4252	High Temp. Rings, pack of 14	12-10	#10	PK	1
4252CX	High Temp. Rings, pack of 100	12-10	#10	PK	1
4253	High Temp. Rings, pack of 14	12-10	1/4"	PK	1
4253CX	High Temp. Rings, pack of 100	12-10	1/4"	PK	1

High Temperature Female Slip-Ons

The High Temperature Female Slip Ons are constructed of nickel plated steel. These non insulated terminals are rated at 900 degree F (482 degree C).



4221

CATALOG NO.	DESCRIPTION	WIRE RANGE	TAB SIZE	UOM	ORDER MULTIPLE
4221	High Temp. Female Slip-Ons, pack of 20	16-14	.187	PK	1
4221CX	High Temp. Female Slip-Ons, pack of 100	16-14	.187	PK	1
4214	High Temp. Female Slip-Ons, pack of 21	16-14	.250	PK	1
4214CX	High Temp. Female Slip-Ons, pack of 100	16-14	.250	PK	1
4204	High Temp. Female Slip-Ons, pack of 17	12-10	.250	PK	1
4204CX	High Temp. Female Slip-Ons, pack of 100	12-10	.250	PK	1

High Temperature Spades

The High Temperature Spades Slip Ons are constructed of nickel plated steel. These non insulated terminals are rated at 900 degree F (482 degree C).



4226

CATALOG NO.	DESCRIPTION	WIRE RANGE	STUD	UOM	ORDER MULTIPLE
4226	High Temp. Spades, pack of 23	16-14	#10	PK	1
4226CX	High Temp. Spades, pack of 100	16-14	#10	PK	1
4254CX	High Temp. Spades, pack of 100	12-10	#10	PK	1

High Temperature Butt Connectors

The High Temperature Butt Connectors are constructed of nickel plated steel. These non insulated terminals are rated at 900 degree F (482 degree C).



4231

CATALOG NO.	DESCRIPTION	WIRE RANGE	UOM	ORDER MULTIPLE
4231	High Temp. Butt Connectors, pack of 17	12-10	PK	1

High Temperature Assortment

The High Temperature Assortment Pack holds terminals that are constructed of nickel plated steel. These non insulated terminals are rated at 900 degree F (482 degree C). Includes parts 4213, 4215, and 4204, and 4254.



4200AX

CATALOG NO.	DESCRIPTION	UOM	ORDER MULTIPLE
4200AX	High Temp. Assortment	EA	1

DEVCO TERMINAL KITS



CATALOG NO.	DESCRIPTION	TERMINALS																
	NOTE: Some kits have parts not shown in chart. Please refer to the DESCRIPTION for these parts. Except where noted, kits come in clear plastic boxes.			HIGH TEMP														
6200HX	Flag Female Compressor Terminal Kit: 8-18 wire range in a 4-compartment box with parts 6270 and 6273 in the same compartment.												6258	6259	6270 6271 6273			
6200MX 6200MSX*	.187, .250 tabs; 12-10 wire range; #8, #10 studs in a 13-compartment polypropylene box.	6217 6231 6232	6218 6235 6251 6281		6216 6252				6213					6259			6211	
6201MX	.187, .250 tabs; 22-10 wire range; #8, #10 studs in a 21-compartment metal box. (Includes parts 6233, 6234, and 6277, not shown in chart).	6217 6231 6232	6218 6235 6251 6281 6282		6216 6236 6252	6228	6238 6239		6224				6258	6259			6211	
6202MX	Insulated Terminal Kit: .187, .250 tabs; 22-10 wire range; #8, #10, #6, 1/4" studs in an 18-compartment box. Parts 6233 & 6234, and parts 6222 & 6223 are pairs (not shown in chart).	6217 6231 6232	6218 6235 6251 6281 6282		6216 6252 6253 6272 60246	60254	6238 6239											
6203MX	Non-Insulated Terminal Kit: Includes High Temp. Terminals and Flag Female Compressor Terminals. .250 tab; 22-10 wire range; #8, #10 studs in an 18-compartment box. (Includes parts 6209 and 6210, not shown in chart).		4204 4213 4214 4215 4252 4254					6214	6213	6224			6258	6259	6270 6271	6230	6208	6211
4200AX	High Temperature Terminal Kit: .250 tab; 16-10 wire; #10 stud in a bag.		4204 4213 4215 4254															
6200X	.250 tab; 16-14 wire; #8 stud in a 6-compartment box.	6217						6214	6213		6215					6230		6211
6200AX	.250 tab; 16-14 wire range; #8, #10 studs in a 6-compartment box.	6217	6218		6216				6213							6230		6211
6200BSX	22-10 wire range in a bag.	6217 6231 6232																
6200CX	.250 tab; 16-14 wire; #10 stud in a 4-compartment box.		6218		6216				6213									6211

*Contains a crimper.

ANCHORS

Metal Drive Anchors

The anchors offer a Quick and Easy Solution for Light Duty Anchoring Jobs in Concrete and Masonry and Easy through type fastening, even when used in bottomless holes

7236RLX



CATALOG NO.	DESCRIPTION	SIZE	EMBEDMENT	PULLOUT LOAD	UOM	ORDER MULTIPLE
7233RLX	Drive Anchor, pack of 50	1/4" X 3/4"	5/8"	500 lb.	PK	1
7234RLX	Drive Anchor, pack of 50	1/4" X 1"	7/8"	944 lb.	PK	1
7235RLX	Drive Anchor, pack of 50	1/4" X 1-1/4"	1-1/8"	1,146 lb.	PK	1
7236RLX	Drive Anchor, pack of 50	1/4" X 1-1/2"	1-3/8"	854 lb.	PK	1

Drop-In Expansion Anchor Setting Tool

This tool is great for use while setting an anchor.

7146



CATALOG NO.	DESCRIPTION	UOM	ORDER MULTIPLE
7146	For use with anchor part number 7142	EA	1

Self-Drilling Gypsum Wallboard Anchors

These anchors pre drill precise holes in gypsum wallboard with no special tools required. The anchors are easily installed with a #2 or #3 Phillips screwdriver, slotted driver, or power driver. Plastic plugs toggles and toggles are easily replaced with the deep threaded products. There is a full range to cover all wall fastening applications and are available in corrosion resistant and non conductive white nylon. The product has a low profile head and can easily be backed out. They provide and strong engagement in 3/4 in., 1/2 in., and 5/8 in. gypsum wallboard and are supplied with combo head screws.

7321X



CATALOG NO.	DESCRIPTION	SCREW SIZE	MAX. FIXTURE	UOM	ORDER MULTIPLE
7316X	E-Z Ancor®, nylon, pack of 10	#8 x 1-1/4"	3/4"	PK	1
7316L	E-Z Ancor®, nylon, pack of 50	#8 x 1-1/4"	3/4"	PK	1
7311L	E-Z Ancor®, zinc die cast*, pack of 50	#6 x 1-1/4"	3/4"	PK	1
7317X	E-Z Ancor Lite™; nylon, pack of 10	#6 x 1-1/4"	3/4"	PK	1
7317L	E-Z Ancor Lite™; nylon, pack of 50	#6 x 1-1/4"	3/4"	PK	1
7321X	E-Z Toggle™; zinc die cast; heavy-duty, pack of 10	#8 x 2-1/8"	5/8"	PK	1

*Smaller version of the E-Z Ancor® with a versatile core that can use #6 or #8 sheet metal screws or #6, #7, #8 drywall screws.

Drive Fasteners

These steel fasteners can be driven into dry wall like a nail and are secured by turning the screw down completely to expand the ribs.

7303



CATALOG NO.	DESCRIPTION	HOLE SIZE	GRIP RANGE	UOM	ORDER MULTIPLE
7302	Drive Fastener, pack of 6	1/4"	1/8" to 1/2"	PK	1
7303	Drive Fastener, pack of 6	1/4"	1/8" to 3/16"	PK	1

Drop-In Expansion Anchors



























These heavy duty anchors are made of carbon steel. They are set by means of an internal plug and setting tool.

7142



CATALOG NO.	DESCRIPTION	BOLT SIZE	THREADS PER INCH	HOLE DEPTH	THREAD DEPTH	DRILL BIT SIZE	UOM	ORDER MULTIPLE
7142	Anchor, pack of 4	3/8"	18	1-5/8"	1/2"	1/2"	PK	1
7142LX	Anchor, pack of 50	3/8"	18	1-5/8"	1/2"	1/2"	PK	1

DEVCO PLASTIC ANCHOR KITS

CATALOG NO.		ANCHOR	DRILL SIZE	DRILL BIT INCLUDED	SCREW	SCREW SIZE
SMALL PACK*	100 PACK					
	7103CX		<u>5/32</u> 			#4 x 3/4"
	7101CX		<u>3/16</u> 			#8 x 1"
	7101HCX					#8 x 1"
	7102CX		<u>1/4</u> 			#10 x 1-1/4"
	7102HCX					#10 x 1"
	7106CX		<u>1/4</u> 			#10 x 1
7105LX			<u>5/16</u> 			#14 x 1-1/2"
7111X	7111CX		<u>5/16</u> 			#14 x 1"

*SMALL PACK	COUNT
7106	28
7111X	40
7105LX	50

BOXES, RINGS, AND COVERS

Steel Utility Boxes*

Steel Utility Boxes are used for convenience outlets, switch boxes and small junction boxes. Galvanized steel.



PI360

CATALOG NO.	LENGTH	WIDTH	DEPTH	CAPACITY (cubic in.)	KNOCKOUT (in.)	UOM	ORDER MULTIPLE
PI360	4"	2-1/8"	1-7/8"	13.0	1/2	EA	1
PI361	4"	2-1/8"	2-1/8"	14.5	1/2	EA	1

Steel 1900 Boxes*

Steel Utility Boxes are used for convenience outlets, switch boxes and small junction boxes. Galvanized steel.



PI362

CATALOG NO.	LENGTH	WIDTH	DEPTH	CAPACITY (cubic in.)	KNOCKOUT (in.)	UOM	ORDER MULTIPLE
PI362	4"	4"	1-1/2"	21.0	3/4 & 1/2	EA	1
PI363	4"	4"	2-1/8"	30.3	3/4 & 1/2	EA	1

Device Rings*

Device rings are designed for projects of preexisting locations. They can help narrow an opening for a box in the sheet rock. They are also known as Plaster Rings. Galvanized steel.



PI387

CATALOG NO.	DESCRIPTION	NUMBER DEVICES	RAISED	UOM	ORDER MULTIPLE
PI387	1900 Device Ring	1	1/2"	EA	1

Extension Rings*

Extension rings are used when extra cubic inch capacity is needed for additional wiring. Galvanized steel.



PI390

CATALOG NO.	LENGTH	WIDTH	DEPTH	CAPACITY (cubic in.)	KNOCKOUT (in.)	UOM	ORDER MULTIPLE
PI390	4"	2-1/8"	1-7/8"	13.0	1/2	EA	1
PI391	4"	4"	1-1/2"	21.0	3/4 & 1/2	EA	1

Utility Covers*

These covers are 4 1/4in. x 2 11/32in. and are designed for appliances or emergency oil burners.



PI383

CATALOG NO.	DESCRIPTION	UOM	ORDER MULTIPLE
PI383	Appliance Switch, .4687" dia. hole, baked cadillite finish	EA	1
PI374	Red finish, "Emergency Gas Burner" in white letters	EA	1

Plated Steel Utility Covers*

Ideal for exposed work applications, providing an easy method for the installation of electrical devices (switches, receptacles, fans, lights, etc.)



PI365

CATALOG NO.	DESCRIPTION	WIDTH	LENGTH	UOM	ORDER MULTIPLE
PI365	Toggle Switch	2-11/32"	4-1/4"	EA	1
PI366	Duplex Receptacle	2-11/32"	4-1/4"	EA	1
PI367	Blank Cover	2-11/32"	4-1/4"	EA	1
PI375	Standard Single Receptacle	2-11/32"	4-1/4"	EA	1

Utility Plates*

These plates are 4 1/4in. x 2 11/32in. and are designed for emergency oil burners.



PI393

CATALOG NO.	DESCRIPTION	UOM	ORDER MULTIPLE
PI393	Red finish, "Emergency Oil Burner" in white letters	EA	1
PI394	Red finish, "Emergency Gas Burner" in white letters	EA	1

*Items in this section are Underwriter's Laboratories listed or recognized under the prime manufacturer's name.



BOXES, RINGS, AND COVERS cont'd

Steel 1900 Covers*

The covers are baked in a cadilite finished steel and are raised 1/2in. with fully depressed corners. Size: 4" x 4".



CATALOG NO.	DESCRIPTION	UOM	ORDER MULTIPLE
PI377	Single Toggle	EA	1
PI378	Single Duplex Receptacle	EA	1
PI379	One Standard Single Receptacle	EA	1
PI368	Toggle Switch and Duplex Receptacle	EA	1
PI370	Toggle Switch and Standard Single Receptacle	EA	1
PI371	Flat, Blank, Galvanized steel (not Cadilite finished)	EA	1

Weatherproof Covers*

These covers can be used with item PI385 and come with gaskets.

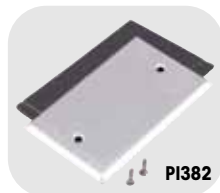

CATALOG NO.	DESCRIPTION	UOM	ORDER MULTIPLE
PI382	Blank Cover	EA	1
PI386	Lever Switch Cover for standard toggle type switches	EA	1
PI389	Duplex Receptacle Cover	EA	1
PI389-GFI	GFI Receptacle Cover	EA	1

Weatherproof Boxes*

Heavy duty die cast aluminum with baked aluminum finish. Boxes have two closure plugs and three holes. Item is Underwriter's Laboratories listed or recognized under the prime manufacturer's name.



CATALOG NO.	LENGTH	WIDTH	DEPTH	CAPACITY (cubic in.)	HOLE SIZE (in.)	UOM	ORDER MULTIPLE
PI385	4-1/2"	2-3/4"	2"	19.0	1/2	EA	1
PI385-34	4-1/2"	2-3/4"	2"	19.0	3/4	EA	1

Weatherproof Box with Lever Switch Cover*

The box is heavy duty die cast aluminum with baked aluminum finish and has two closure plugs and three holes. The cover comes with the gaskets. Includes parts PI385 and PI386.



CATALOG NO.	DESCRIPTION	UOM	ORDER MULTIPLE
PI384	Weatherproof Box and Lever Switch Cover	EA	1

Safety Plates*

Safety plates, also called nail in plates, or nail plates, install quickly and protect wire, cable and pipes that may be installed in upright wood stud walls.



CATALOG NO.	DESCRIPTION	UOM	ORDER MULTIPLE
PI232CX	Safety Plate – approximately 6"	EA	100

CABLE CONNECTORS

Zinc Plated Die Cast Steel Romex Connectors*

These zinc plated die cast connectors are for use with Romex, Service, and UF Cables.



CATALOG NO.	DESCRIPTION	TRADE SIZE	KNOCKOUT	UOM	ORDER MULTIPLE
PI321	Zinc plated die cast Romex Connector, pack of 8	3/8"	1/2"	PK	1
PI320	Zinc plated die cast Romex Connector, pack of 25	3/8"	1/2"	PK	1
PI319	Zinc plated die cast Romex Connector, pack of 4	3/4"	3/4"	PK	1
PI319CX	Zinc plated die cast Romex Connector, pack of 100	3/4"	3/4"	PK	1

Rigid Conduit Bodies*

These bodies are Aluminum and can be use indoor or outdoor. Use to gain access to the interior of a raceway for wire pulling, splicing (with limitations as specified by the NEC), and maintenance. This item comes with cover and gasket.



CATALOG NO.	DESCRIPTION	TRADE SIZE	BODY TYPE	UOM	ORDER MULTIPLE
PI458	Includes steel cover, screws, gasket	1/2"	Back (LB)	EA	1
PI459	Includes steel cover, screws, gasket	3/4"	Back (LB)	EA	1

*Items in this section are Underwriter's Laboratories listed or recognized under the prime manufacturer's name.

CABLE CONNECTORS cont'd

BX and Greenfield Connectors*

These connectors are used to terminate Flexible Metal Conduit to a knock out in a dry location box or enclosure. Zinc die cast.



CATALOG NO.	DESCRIPTION	TRADE SIZE	KNOCKOUT	UOM	ORDER MULTIPLE
PI311	Set Screw Type Connector, 25 per pack	3/8"	1/2"	PK	1
PI312	Set Screw Type Connector, 8 per pack	3/8"	1/2"	PK	1
PI322	Straight Connector, squeeze type, for armored cable and flexible conduit, 8 per pack	3/8"	1/2"	PK	1
PI315	90° Connector, 3 per pack	3/8"	1/2"	PK	1
PI341	90° Connector, 4 per pack	1/2"	1/2"	PK	1
PI340	Combination Cable Connector suitable for Romex or BX and Greenfield, 8 per pack	3/8"	1/2"	PK	1
PI318	Duplex Connector with single screw, clamp type, 2 per pack	3/8"	1/2"	PK	1

Liquid-Tite Connectors*

These connectors are made of zinc die cast and can be used with Flexible Metal Conduits and non metallic conduits. Zinc die cast.



CATALOG NO.	DESCRIPTION	TRADE SIZE	KNOCKOUT	UOM	ORDER MULTIPLE
PI350	Straight Liquid-Tite Connector, 2 per pack	1/2"	1/2"	PK	1
PI351	Straight Liquid-Tite Connector, 2 per pack	3/4"	3/4"	PK	1
PI352	90° Liquid-Tite Connector	1/2"	1/2"	EA	1
PI353	90° Liquid-Tite Connector	3/4"	3/4"	EA	1

Thinwall E.M.T. Connectors*

These are used to join EMT conduit to boxes on enclosures. Zinc die cast.



CATALOG NO.	DESCRIPTION	TRADE SIZE	KNOCKOUT	UOM	ORDER MULTIPLE
PI411	Compression Type Connectors, 8 per pack	1/2"	1/2"	PK	1
PI412	Compression Type Connectors, 8 per pack	3/4"	3/4"	PK	1
PI416	Compression Type Couplings, 8 per pack	3/4"		PK	1
PI426	Compression Type Straight Connectors for connecting E.M.T. to Liquid-Tight, 8 per pack	3/4"		PK	1
PI419	Set Screw Type Connectors, 8 per pack	1/2"	1/2"	PK	1

CABLE TIES AND ACCESSORIES

Heavy Duty Nylon Cable Ties

Black ties are weather and UV resistant. Items in this section are Underwriters' Laboratories listed or recognized under the prime manufacturer's name.

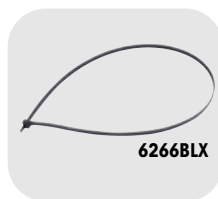

CATALOG NO.	DESCRIPTION	LENGTH	COLOR	MAX. BUNDLE DIAMETER	TENSILE STRENGTH	UOM	ORDER MULTIPLE
6265BLX	Nylon; Heavy-duty, pack of 50	14"	Black	4"	175 lb.	PK	1
6265BCX	Nylon; Heavy-duty, pack of 100	14"	Black	4"	175 lb.	PK	1
6266BLX	Nylon; Heavy-duty, pack of 50	36"	Black	11"	175 lb.	PK	1

Nylon Cable Ties with Mounting Hole

Black ties are weather and UV resistant. Items in this section are Underwriters' Laboratories listed or recognized under the prime manufacturer's name.

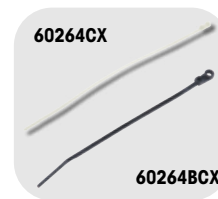

CATALOG NO.	DESCRIPTION	MOUNTING HOLE	LENGTH	COLOR	MAX. BUNDLE DIAMETER	TENSILE STRENGTH	UOM	ORDER MULTIPLE
60264CX	Tie w/mtg. hole, pack of 100	#8	6"	Natural	1-3/8"	30 lb.	PK	1
60264BCX	Tie w/mtg. hole, pack of 100	#8	6"	Black	1-3/8"	30 lb.	PK	1
6264LX	Tie w/mtg. hole, pack of 50	#10	7"	Natural	1-3/4"	50 lb.	PK	1
6264CX	Tie w/mtg. hole, pack of 100	#10	7"	Natural	1-3/4"	50 lb.	PK	1
6264BCX	Tie w/mtg. hole, pack of 100	#10	7"	Black	1-3/4"	50 lb.	PK	1
60263CX	Tie w/mtg. hole, pack of 100	#10	11"	Natural	3"	50 lb.	PK	1
60263BLX	Tie w/mtg. hole, pack of 50	#10	11"	Black	3"	50 lb.	PK	1
60263BCX	Tie w/mtg. hole, pack of 100	#10	11"	Black	3"	50 lb.	PK	1

*Items in this section are Underwriter's Laboratories listed or recognized under the prime manufacturer's name.



CABLE TIES AND ACCESSORIES cont'd

Nylon Cable Ties

Black ties are weather and UV resistant. Items in this section are Underwriters' Laboratories listed or recognized under the prime manufacturer's name.

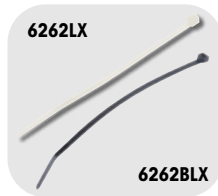

CATALOG NO.	DESCRIPTION	LENGTH	COLOR	MAX. BUNDLE DIAMETER	TENSILE STRENGTH	UOM	ORDER MULTIPLE
6267MX	Nylon Cable Ties, pack of 1,000	4"	Natural	13/16"	18 lb.	PK	1
6261CX	Nylon Cable Ties, pack of 100	6"	Natural	1-3/8"	18 lb.	PK	1
6261BCX	Nylon Cable Ties, pack of 100	6"	Black	1-3/8"	18 lb.	PK	1
6268BMX	Nylon Cable Ties, pack of 1,000	6"	Black	1-3/8"	30 lb.	PK	1
6262LX	Nylon Cable Ties, pack of 50	7-1/2"	Natural	1-3/4"	50 lb.	PK	1
6262CX	Nylon Cable Ties, pack of 100	7-1/2"	Natural	1-3/4"	50 lb.	PK	1
6262MX	Nylon Cable Ties, pack of 1,000	7-1/2"	Natural	1-3/4"	50 lb.	PK	1
6262BLX	Nylon Cable Ties, pack of 50	7-1/2"	Black	1-3/4"	50 lb.	PK	1
6262BCX	Nylon Cable Ties, pack of 100	7-1/2"	Black	1-3/4"	50 lb.	PK	1
6262BMX	Nylon Cable Ties, pack of 1,000	7-1/2"	Black	1-3/4"	50 lb.	PK	1
6263LX	Nylon Cable Ties, pack of 50	11"	Natural	3"	50 lb.	PK	1
6263CX	Nylon Cable Ties, pack of 100	11"	Natural	3"	50 lb.	PK	1
6263DX	Nylon Cable Ties, pack of 500	11"	Natural	3"	50 lb.	PK	1
6263BLX	Nylon Cable Ties, pack of 50	11"	Black	3"	50 lb.	PK	1
6263BCX	Nylon Cable Ties, pack of 100	11"	Black	3"	50 lb.	PK	1
6263BDX	Nylon Cable Ties, pack of 500	11"	Black	3"	50 lb.	PK	1
60265LX	Nylon Cable Ties, pack of 50	14"	Natural	4"	50 lb.	PK	1
60265BLX	Nylon Cable Ties, pack of 50	14"	Black	4"	50 lb.	PK	1

Black Nylon Cable Tie Assortment

Black ties are weather and UV resistant. Items in this section are Underwriters' Laboratories listed or recognized under the prime manufacturer's name.

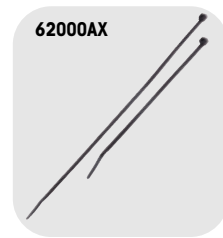

CATALOG NO.	DESCRIPTION	LENGTH	COLOR	MAX. BUNDLE DIAMETER	TENSILE STRENGTH	UOM	ORDER MULTIPLE
62000AX	Assortment	7-1/2"	Black	1-3/4"	50 lb.	PK	1
		11"	Black	3"	50 lb.		

Cable Tie Mounts

Approximately 1in. square adhesive backed. These mounts can be mounted with a screw and will accept up to 75 lb. ties.



CATALOG NO.	DESCRIPTION	UOM	ORDER MULTIPLE
6269	Cable Tie Mounts; 1" square; adhesive backed, pack of 11	PK	1
6269LX	Cable Tie Mounts; 1" square; adhesive backed, pack of 50	PK	1
6269MX	Cable Tie Mounts; 1" square; adhesive backed, pack of 1,000	PK	1

CONDUIT FITTINGS

Straps

Our zinc plated steel straps are designed to hold conduit pipe.



CATALOG NO.	DESCRIPTION	UOM	ORDER MULTIPLE
PI306	Straps fit 1/2" E.M.T. Conduit, pack of 20	PK	1
PI306CX	Straps fit 1/2" E.M.T. Conduit, pack of 100	PK	1
PI307	Straps fit 3/4" E.M.T. Conduit, pack of 12	PK	1
PI307CX	Straps fit 3/4" E.M.T. Conduit, pack of 100	PK	1
PI908	Straps fit 1" E.M.T. Conduit, pack of 10	PK	1
PI908CX	Straps fit 1" E.M.T. Conduit, pack of 100	PK	1
PI909LX	Straps fit 1-1/4" E.M.T. Conduit, pack of 50	PK	1
PI206	Straps for 14-2 Romex, pack of 20	PK	1

Knockout Seals and Hole Plug



CATALOG NO.	DESCRIPTION	UOM	ORDER MULTIPLE
PI316	For 1/2" knockouts, zinc plated steel, pack of 10	PK	1
PI317	For 3/4" knockouts, zinc plated steel, pack of 10	PK	1
ED406	Nylon Hole Plug for 3/8" hole, pack of 28	PK	1

Reducing Washers

Reducing washers are for reducing knockout holes. These washers have raised flanges for a tight fit and are made of galvanized steel. PI308 reduces hole to fit appliance switch.



CATALOG NO.	DESCRIPTION	UOM	ORDER MULTIPLE
PI304	Reducing Washer - reduces hole from 1" to 1/2", pack of 10	PK	1
PI305	Reducing Washer - reduces hole from 1" to 3/4", pack of 10	PK	1
PI310	Reducing Washer - reduces hole from 3/4" to 1/2", pack of 28	PK	1
PI310LX	Reducing Washer - reduces hole from 3/4" to 1/2", pack of 50	PK	1
PI912	Reducing Washer - reduces hole from 2" to 3/4", pack of 5	PK	1
PI912LX	Reducing Washer - reduces hole from 2" to 3/4", pack of 50	PK	1
PI913	Reducing Washer - reduces hole from 1-1/2" to 1/2", pack of 4	PK	1
PI914	Reducing Washer - reduces hole from 1-1/2" to 3/4", pack of 4	PK	1

Conduit Nipples*

Used to connect two electrical utility boxes where room is limited. Zinc die cast steel. Comes with plated steel locknuts.



CATALOG NO.	DESCRIPTION	SIZE	CONNECTION	UOM	ORDER MULTIPLE
PI203	Conduit Nipple, pack of 6	1/2"	Straight	PK	1

CONDUIT FITTINGS cont'd

Conduit Nipples*

PI301 is zinc die cast steel. PI303 is galvanized steel. All come with plated steel locknuts and plastic insulating bushings.



CATALOG NO.	DESCRIPTION	SIZE	CONNECTION	UOM	ORDER MULTIPLE
PI301	Conduit Nipple, pack of 2	1/2"	Offset	PK	1
PI303	Conduit Nipple, pack of 2	1/2" x 2"	Straight	PK	1

Bushings and Locknuts

The locknuts and bushing are straight connectors provide excellent pullout strength and can be installed without disassembly. The compression nut ratchet prevents unintentional loosening.



CATALOG NO.	DESCRIPTION	UOM	ORDER MULTIPLE
PI331	Plastic "Anti-Short" Bushings for 14/2, 14/3, 12/2 BX cable, pack of 35	PK	1

Electrical Staples

We have steel, insulated copper finish, and plastic electrical staples available.



CATALOG NO.	DESCRIPTION	SIZE	UOM	ORDER MULTIPLE
PI330	Plastic; for 2 conductor Romex and other NM cable conductor; 12/2-14/2 range; UV protected, pack of 50	3/8" x 1/2"	PK	1
PI332	Plastic; for 3 conductor Romex and other NM cable conductor; 12/3-14/3 range; UV protected, pack of 50	3/8" x 3/4"	PK	1
PI309	Steel; non-insulated for Romex and NM cable; 14/2-10/3 range, pack of 154	1" x 1/2"	PK	1
ED273	Insulated coppered finish; size #5, pack of 50	5/8" x 1/4"	PK	1
ED273CX	Insulated coppered finish; size #5, pack of 100	5/8" x 1/4"	PK	1

GENERAL TOOLS

Devco Crimpers

Crimps insulated and non insulated terminals 22 to 10 AWG, cuts bolts #4 40 through #10 24, and strips stranded wire 22 to 10 AWG and solid wire 18 to 8 AWG. Features two precision ground wire cutters, one on the nose and the other behind the pivot point. Plastic cushion handle.



CATALOG NO.	DESCRIPTION	UOM	ORDER MULTIPLE
5002	Devco Crimpers; plastic coated handle	EA	1

Blind Rivet Tools

Heavy duty hand rivet tool that offers long handles to increase leverage and to secure the rivet in the nosepiece while the tool is in use. Powerful riveting capacity with 4 standard nosepieces to set 3/32, 1/8, 5/32, and 3/16" blind rivets.



CATALOG NO.	DESCRIPTION	UOM	ORDER MULTIPLE
5107	Heavy-duty tool; 4 interchangeable nose pieces to accommodate 3/32", 1/8", 5/32", 3/16" steel or aluminum rivets	EA	1

Magnetic Hex Chucks

Magnetic Hex Chucks may be used with an electric drill to drive hex washer head screws.



CATALOG NO.	DESCRIPTION	HEX HEAD SIZE	HEX HEAD DIAMETER	LENGTH	UOM	ORDER MULTIPLE
DE13	Magnetic Hex Chuck	1/4"	7/16"	1-3/4"	EA	1
DE14	Magnetic Hex Chuck	5/16"	1/2"	1-3/4"	EA	1
DE15	Magnetic Hex Chuck	3/8"	9/16"	1-7/8"	EA	1
DE23	Magnetic Hex Chuck	1/4"	7/16"	2-9/16"	EA	1
DE24	Magnetic Hex Chuck	5/16"	1/2"	2-9/16"	EA	1
DE33**	Magnetic Hex Chuck	1/4"	7/16"	3"	EA	1

**Magnetic insert bit holder with a "C" ring retainer

*Items in this section are Underwriter's Laboratories listed or recognized under the prime manufacturer's name.



NUTS AND BOLTS

Finished Hex Nuts

The hex nuts are zinc plated steel.



CATALOG NO.	DESCRIPTION	SIZE	UOM	ORDER MULTIPLE
6501	Finished Hex Nuts, pack of 60	1/4" - 20	PK	1
6501CX	Finished Hex Nuts, pack of 100	1/4" - 20	PK	1
6502	Finished Hex Nuts, pack of 38	5/16" - 18	PK	1
6503	Finished Hex Nuts, pack of 25	3/8" - 16	PK	1
6503CX	Finished Hex Nuts, pack of 100	3/8" - 16	PK	1
6505	Finished Hex Nuts, pack of 11	1/2" - 13	PK	1
6505LX	Finished Hex Nuts, pack of 50	1/2" - 13	PK	1

Stove Bolts

Stove Bolts are a combination of slotted round head machine screws and finished hex nuts. They are made of zinc plated steel.



CATALOG NO.	DESCRIPTION	SIZE	LENGTH	UOM	ORDER MULTIPLE
6401	Stove Bolts, pack of 42	#10 - 24	1/2"	PK	1
6402	Stove Bolts, pack of 38	#10 - 24	3/4"	PK	1
6403	Stove Bolts, pack of 34	#10 - 24	1"	PK	1
6404	Stove Bolts, pack of 27	#10 - 24	1-1/2"	PK	1
6411	Stove Bolts, pack of 22	1/4" - 20	1/2"	PK	1
6412	Stove Bolts, pack of 20	1/4" - 20	3/4"	PK	1
6413	Stove Bolts, pack of 18	1/4" - 20	1"	PK	1
6414	Stove Bolts, pack of 15	1/4" - 20	1-1/2"	PK	1
6415	Stove Bolts, pack of 13	1/4" - 20	2"	PK	1
6416	Stove Bolts, pack of 11	1/4" - 20	2-1/2"	PK	1

Flat Washers

These washers are zinc plated steel with a USS Classification.

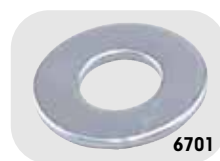

CATALOG NO.	DESCRIPTION	SIZE	INNER DIAMETER	OUTER DIAMETER	UOM	ORDER MULTIPLE
6701	Flat Washers (USS), pack of 160	3/16"	1/4"	9/16"	PK	1
6702	Flat Washers (USS), pack of 72	1/4"	5/16"	3/4"	PK	1
6703	Flat Washers (USS), pack of 33	5/16"	3/8"	7/8"	PK	1
6704	Flat Washers (USS), pack of 37	3/8"	7/16"	1"	PK	1
6704-2X	Flat Washers (USS), pack of 134	3/8"	7/16"	1"	PK	1
6706	Flat Washers (USS), pack of 11	1/2"	9/16"	1-3/8"	PK	1
6706-2X	Flat Washers (USS), pack of 52	1/2"	9/16"	1-3/8"	PK	1
6700AX	Assortment	All sizes included			EA	1

Machine Screw Hex Nuts

The hex nuts are zinc plated steel.



CATALOG NO.	DESCRIPTION	SIZE	UOM	ORDER MULTIPLE
6526	Machine Screw Hex Nuts, pack of 49	#8 - 32	PK	1
6528	Machine Screw Hex Nuts, pack of 44	#10 - 24	PK	1
6500A	Assortment, 23 of each	#6-32, #8-32, #10-32	EA	1

Toggle Bolts

The toggle bolts are slotted round head machine screws with spring wings and are made of zinc plated steel.



CATALOG NO.	DESCRIPTION	LENGTH	BOLT SIZE	HOLE SIZE	UOM	ORDER MULTIPLE
7033	Toggle Bolts, pack of 6	4"	3/16"	1/2"	PK	1
7034	Toggle Bolts, pack of 5	4"	1/4"	5/8"	PK	1
7036X	Toggle Bolts, pack of 4	4"	3/8"	1"	PK	1
7066X	Toggle Bolts, pack of 4	6"	3/8"	1"	PK	1

Hex Head Cap Screws

Hex Screw Cap Screws are made of low carbon, grade 2 steel and are USS Classified. The total thread length on these screws equal 2x diameter + 1/4in.



CATALOG NO.	DESCRIPTION	SIZE	LENGTH	UOM	ORDER MULTIPLE
6601	Hex Head Cap Screws, pack of 28	1/4" - 20	3/4"	PK	1
6602	Hex Head Cap Screws, pack of 25	1/4" - 20	1"	PK	1
6603	Hex Head Cap Screws, pack of 18	1/4" - 20	1-1/2"	PK	1
6622	Hex Head Cap Screws, pack of 15	5/16" - 18	1"	PK	1
6623	Hex Head Cap Screws, pack of 12	5/16" - 18	1-1/2"	PK	1
6641	Hex Head Cap Screws, pack of 14	3/8" - 16	3/4"	PK	1
6642	Hex Head Cap Screws, pack of 12	3/8" - 16	1"	PK	1
6643	Hex Head Cap Screws, pack of 8	3/8" - 16	1-1/2"	PK	1
6644	Hex Head Cap Screws, pack of 7	3/8" - 16	2"	PK	1
6645	Hex Head Cap Screws, pack of 5	3/8" - 16	2-1/2"	PK	1
6685	Hex Head Cap Screws, pack of 3	1/2" - 13	2-1/2"	PK	1

Medium Split Lock Washers

Spring type. These washers are made of zinc plated steel.



CATALOG NO.	DESCRIPTION	SIZE	UOM	ORDER MULTIPLE
6730	Medium Split Lock Washers, pack of 95	3/16"	PK	1
6731	Medium Split Lock Washers, pack of 72	1/4"	PK	1
6732	Medium Split Lock Washers, pack of 59	5/16"	PK	1
6733	Medium Split Lock Washers, pack of 38	3/8"	PK	1
6735	Medium Split Lock Washers, pack of 18	1/2"	PK	1

NUTS AND BOLTS cont'd

Fender Washers

These washers are made of zinc plated steel.

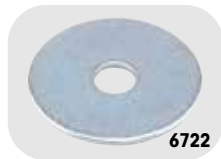

CATALOG NO.	DESCRIPTION	SIZE	INNER DIAMETER	OUTER DIAMETER	UOM	ORDER MULTIPLE
6722	Fender Washers, pack of 20	1/4"	9/32"	1-1/4"	PK	1
6722-2X	Fender Washers, pack of 92	1/4"	9/32"	1-1/4"	PK	1
6724	Fender Washers, pack of 12	3/8"	13/32"	1-1/2"	PK	1
6724-2X	Fender Washers, pack of 66	3/8"	13/32"	1-1/2"	PK	1

POWER CORDS AND WORK LIGHTS

Round Extension Cords*

Comes in bright orange or yellow, depending upon availability.



CATALOG NO.	DESCRIPTION	WIRE	LENGTH	RATING	UOM	ORDER MULTIPLE
5230	Round Extension Cord	14/3	100'	13A/125V	EA	1

Trouble Lights*

These all weather lights are extra flexible with metal guards.



CATALOG NO.	DESCRIPTION	WIRE	CORD LENGTH	RATING	UOM	ORDER MULTIPLE
5200	Trouble Light	16/3	25'	13A/125V	EA	1
5201	Trouble Light	16/3	50'	13A/125V	EA	1

SCREWS

Combo Head Sheet Metal Screws

These screws are used on sheet metal items.



CATALOG NO.	DESCRIPTION	LENGTH	SCREW SIZE	UOM	ORDER MULTIPLE
6853	Combo Head Screws, pack of 48	1/2"	#10	PK	1
6855	Combo Head Screws, pack of 46	3/4"	#10	PK	1
6858	Combo Head Screws, pack of 26	1-1/2"	#10	PK	1
6859	Combo Head Screws, pack of 19	2"	#10	PK	1
6865	Combo Head Screws, pack of 32	3/4"	#12	PK	1
6866	Combo Head Screws, pack of 26	1"	#12	PK	1
6876	Combo Head Screws, pack of 20	1"	#14	PK	1

Sheet Metal Screw Assortments

6800BX and 6800HX come in a four compartment, clear plastic box.



CATALOG NO.	DESCRIPTION	UOM	ORDER MULTIPLE
6800HX	Slotted Hex Washer Head Screws: #6 x 3/8", #8 x 1/2", #8 x 3/4", #10 x 3/4", #10 x 1"	EA	1

Self-Drilling Screw Repair Kit

These screws are used for replacements in striped holes.



CATALOG NO.	DESCRIPTION	UOM	ORDER MULTIPLE
6900AX	Contains: #12 x 3/4", #12 x 1", #14 x 3/4", #14 x 1"	EA	1

Self-Drilling Screws

Zinc plated steel. Self drilling screws drill and tap holes in one step. Hex washer heads. #8 and #10 screws are designed for use with material thickness of .035" to .110"; #12 and #14 screws are designed for use with .110" to .220" material thickness.



CATALOG NO.	DESCRIPTION	UOM	ORDER MULTIPLE
6943CX	Hex Head Self Drilling Screw, 1/4in. Head #8 x 1/2in., 100 pcs	EA	1
6945CX	Hex Head Self Drilling Screw, Zinc Plated, #8 x 3/4in., 100 pcs	EA	1
6946CX	Hex Head Self Drilling Screw, 1/4in. Head #8 x 1in, 100 pcs	EA	1
6953CX	Hex Washer Head Self Drilling Screws 5/16in. Head #10 x 1/2in 100 pcs	EA	1
6955CX	Hex Head Self Drilling Screw, 5/16in. Head #10 x 3/4in., 100 pcs	EA	1
6956CX	Hex Washer Head Self Drilling Screws 5/16in. Head #10 x 1in 100 pcs	EA	1



SPECIALTY FASTENERS

Nylon Cable Clamps

These cable clamps are perfect for securing wire or pipes.



CATALOG NO.	DESCRIPTION	FITS PIPE OUTER DIAMETER	THICKNESS	WIDTH	UOM	ORDER MULTIPLE
5381	Nylon Cable Clamps, pack of 54	1/8"	.050"	3/8"	PK	1
5382	Nylon Cable Clamps, pack of 48	1/4"	.050"	3/8"	PK	1
5383	Nylon Cable Clamps, pack of 41	3/8"	.050"	3/8"	PK	1
5384	Nylon Cable Clamps, pack of 35	1/2"	.050"	3/8"	PK	1
5385	Nylon Cable Clamps, pack of 21	5/8"	.060"	1/2"	PK	1
5380AX	Assortment	1/8" - 1"			EA	1

Pipe Hanging Strap

Non plated Steel Pipe hanging Strap is perfect for hanging pipes, fastening faucets and valves, as well as repair jobs.



CATALOG NO.	DESCRIPTION	SIZE	UOM	ORDER MULTIPLE
P1335	Pipe Hanging Strap; 28 gauge AWG	3/4" x 10'	EA	1

Cotter Pins

Cotter Pins provide smooth locking between two parts. This set includes an assortment of regular Cotter Pins with extended prongs.



CATALOG NO.	DESCRIPTION	UOM	ORDER MULTIPLE
6011	Cotter Pins: 1/16" x 1-1/2"; 3/32" x 1-1/2"; 1/8" x 1-1/2", pack of 51	PK	1

Motor Shaft Key Assortments

You can use choose from either a large assortment or a small assortment. The keys are made of cold rolled 1018 steel and are zinc plated.



CATALOG NO.	DESCRIPTION	UOM	ORDER MULTIPLE
6101	Small Assortment includes: 1/8" x 1/8" x 1-3/16"; 3/16" x 3/16" x 1-3/16"; 3/16" x 1/4" x 1-3/16"; 1/4" x 1/4" x 1-3/4"	EA	1
6102	Large Assortment includes: 1/4" x 1/4" x 1-3/4"; 5/16" x 5/16" x 3"; 3/8" x 3/8" x 3	EA	1

Hose Clamps

Hose Clamps have stainless steel housings and bands. The screws are plated steel and have slotted hex heads allowing a socket wrench, nut driver, or screwdriver to be used.



CATALOG NO.	DESCRIPTION	SAE NO.	SAE DIAMETER RANGE (in.)	APPROX. RANGE (in.)	UOM	ORDER MULTIPLE
HC6202	Hose Clamps, pack of 6	*	N/A	1/4 to 5/8	PK	1
HC6203	Hose Clamps, pack of 6	6	.44 - .78	5/16 to 7/8	PK	1
HC5410	Hose Clamps, pack of 6	10	.56 - 1.06	9/16 to 1-1/8	PK	1
HC5410X	Hose Clamps, pack of 10	10	.56 - 1.06	9/16 to 1-1/8	PK	1
HC5416	Hose Clamps, pack of 6	16	.81 - 1.50	3/4 to 1-1/2	PK	1
HC5416X	Hose Clamps, pack of 10	16	.81 - 1.50	3/4 to 1-1/2	PK	1
HC5420	Hose Clamps, pack of 6	20	.81 - 1.75	13/16 to 1-3/4	PK	1
HC5424	Hose Clamps, pack of 6	24	1.06 - 2.00	1-1/16 to 2	PK	1
HC5436	Hose Clamps, pack of 4	36	1.81 - 2.75	1-1/2 to 2-3/4	PK	1

Set Screws

Set Screws have cup points and hex socket heads. Class 3A threads. Made of heat treated alloy steel.



CATALOG NO.	DESCRIPTION	SIZE	UOM	ORDER MULTIPLE
6000	Large Assortment; course thread	1/4"-20; 5/16"-18; 3/8"-16	EA	1
6001	Small Assortment; fine thread	#8-32; #10-32; 1/4"-28	EA	1

*Items in this section are Underwriter's Laboratories listed or recognized under the prime manufacturer's name.



SPECIALTY FITTINGS

Grease Fittings

Case hardened steel fittings plated with yellow dip chromate and built-in ball checks. Assortment available in clear plastic box.

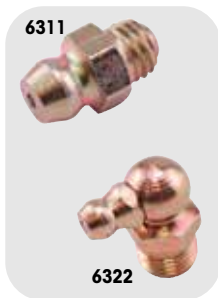

CATALOG NO.	DESCRIPTION	UOM	ORDER MULTIPLE
6311	Grease Fittings: 1/4"-28 Tapered Thread; straight, pack of 8	PK	1
6312	Grease Fittings: 1/8" Pipe Thread; straight, pack of 5	PK	1
6321	Grease Fittings: 1/4"-28 Tapered Thread; 90°, pack of 3	PK	1
6322	Grease Fittings: 1/8" Pipe Thread; 90°, pack of 3	PK	1
6310X	Assortment includes: 6311, 6312, 6321, 6322	EA	1

STORAGE CONTAINERS

Metal Parts Boxes

Metal Parts Boxes are prime cold rolled steel with baked gray enamel finish. The finish is rust and acid resistant. Each box comes with high impact plastic tray, positive pull down catch, and stick back parts labels for lid interiors.



Satchel Style Case

Parts box made from rugged copolymer material with high impact translucent lid and handle on the side. 15 removable dividers allow up to 24 compartments.



CATALOG NO.	DESCRIPTION	NO. OF COMPARTMENTS	DIMENSIONS (L x W x D)	UOM	ORDER MULTIPLE
8200M	Metal Parts Box	21	13-3/8" x 9-1/4" x 2"	EA	1
8220M	Metal Parts Box	24	18" x 12" x 3"	EA	1

CATALOG NO.	DESCRIPTION	NO. OF COMPARTMENTS	DIMENSIONS (L x W x D)	UOM	ORDER MULTIPLE
8233	Satchel Style Case	Up to 24	15" x 11-3/4" x 2-1/2"	EA	1

Polypropylene Parts Boxes

This box is ideal for holding your different sized nuts and bolts along with your additional bits. It can be stored in a tool box as well.



CATALOG NO.	DESCRIPTION	COLOR	NO. OF COMPARTMENTS	DIMENSIONS (L x W x D)	UOM	ORDER MULTIPLE
8201C	Polypropylene Parts Box Translucent		13	11" x 6-3/4" x 1-1/4"	EA	1
8203C	Polypropylene Parts Box Translucent		24	13-1/8" x 9" x 2-5/8"	EA	1

TAPES

Tape

Vinyl electrical tape. Part 5247 holds up to 7 pounds per square inch when attached to steel surface.



Teflon® Tape

This PTFE Tape is made of non toxic, pure white PTFE. The tape can be used with chemicals, solvents, oxygen, and on food lines. The product can withstand up to 2000 psi of pressure.



CATALOG NO.	DESCRIPTION	LENGTH	UOM	ORDER MULTIPLE
5255	Vinyl Electrical Tape	3/4" x 60'	EA	1

CATALOG NO.	DESCRIPTION	LENGTH	UOM	ORDER MULTIPLE
5246	Teflon® Thread Seal Tape	1/2" x 520'	EA	1



TESTERS, LEADS, CLIPS, FUSES

Clips

The clips are alligator clips and have vinyl red and black insulators.



CATALOG NO.	DESCRIPTION	UOM	ORDER MULTIPLE
5033	Steel Alligator Clips for use with test probes (.075"-.080"); 1-31/32" long; jaws open 5/16" max., pack of 2 red, 2 black, 4 clips	PK	1
5035	Copper Alligator Clips; 1-31/32" long; jaws open 5/16" max.; crimper slotted screw connection, pack of 2 red, 2 black, 4 clips	PK	1
5036	Steel Test Clips; 20A, 2-7/16" long; jaws open 5/8" max.; crimper slotted screw connection, pack of 1 red, 1 black, 2 clips	PK	1

Blade (Auto) Fuses

These fuses are used to protect circuits in the wiring harness that are usually found under the hood, in a fuse panel or supplementary panel near the battery. MAX fuses are used in domestic and import vehicles.



CATALOG NO.	DESCRIPTION	UOM	ORDER MULTIPLE
ED-AT3	Blade Fuse – 3 Amp – Purple, pack of 10	PK	1
ED-AT5	Blade Fuse – 5 Amp – Tan, pack of 10	PK	1

Test Leads

These are replacement leads.



CATALOG NO.	DESCRIPTION	UOM	ORDER MULTIPLE
5031	Low Voltage Test Leads; eight 22" long, color-coded leads with fully insulated alligator clips	EA	1
5041	Small Hook Type Low Voltage Test Leads; retractable hooks, 36" thermoplastic 22 gauge wire, nylon body/plunger, red/black	EA	1
5042	Large Hook Type Low Voltage Test Leads; retractable hooks, 36" PVC insulated 20 gauge wire, nylon body/plunger, red/black	EA	1
5046	Flexible Test Leads; steel alligator clips with vinyl red and black insulators; 36" 20 gauge wire; extremely flexible	EA	1

Dual Element Fuses – 250V

Provides time delay for temporary over-current conditions and motor running protection for heating and air conditioning equipment. Eliminates unnecessary maintenance from harmless overloads.



CATALOG NO.	DESCRIPTION	UOM	ORDER MULTIPLE
ED-CR15	Dual Element Fuse – 15 Amps, pack of 2	PK	1
ED-CR20	Dual Element Fuse – 20 Amps, pack of 2	PK	1
ED-CR25	Dual Element Fuse – 25 Amps, pack of 2	PK	1
ED-CR30	Dual Element Fuse – 30 Amps, pack of 2	PK	1
ED-CR35	Dual Element Fuse – 35 Amps, pack of 2	PK	1
ED-CR40	Dual Element Fuse – 40 Amps, pack of 2	PK	1
ED-CR45	Dual Element Fuse – 45 Amps, pack of 2	PK	1
ED-CR50	Dual Element Fuse – 50 Amps, pack of 2	PK	1
ED-CR60	Dual Element Fuse – 60 Amps, pack of 2	PK	1

U.L. Class RK-5, Standard for Safety 198E, Current Limiting Fuses, Interrupting Rating 200,000 Amps. rms. A.C.

WIRE

TFFN Stranded Hook-Up Wire*

Packaged in handy dispenser bag. Polyvinyl chloride insulation. Wire rating: 600V, 90°C. Insulation: oil resistant nylon coating.

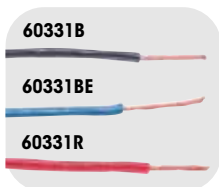

CATALOG NO.	COLOR	GAUGE	STRANDS	O.D.	LENGTH	UOM	ORDER MULTIPLE
60331B	Black, pack of 50'	18	16	.09"	48'	PK	1
60331BE	Blue, pack of 50'	18	16	.09"	48'	PK	1
60331R	Red, pack of 50'	18	16	.09"	48'	PK	1
6332B	Black, pack of 50'	16	26	.10"	48'	PK	1
6332G	Green, pack of 50'	16	26	.10"	48'	PK	1
6332R	Red, pack of 50'	16	26	.10"	48'	PK	1
6332W	White, pack of 50'	16	26	.10"	48'	PK	1

THHN Stranded Hook-Up Wire*

Packaged in handy dispenser bag. Polyvinyl chloride insulation. Wire rating: 600V, 90°C. Insulation: oil resistant nylon coating.

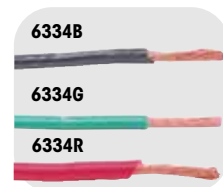

CATALOG NO.	COLOR	GAUGE	STRANDS	O.D.	LENGTH	UOM	ORDER MULTIPLE
6333B	Black, pack of 50'	14	19	.11"	48'	PK	1
6333G	Green, pack of 50'	14	19	.11"	48'	PK	1
6333R	Red, pack of 50'	14	19	.11"	48'	PK	1
6333W	White, pack of 50'	14	19	.11"	48'	PK	1
6334B	Black, pack of 50'	12	19	.13"	48'	PK	1
6334G	Green, pack of 50'	12	19	.13"	48'	PK	1
6334R	Red, pack of 50'	12	19	.13"	48'	PK	1
6334W	White, pack of 50'	12	19	.13"	48'	PK	1
6335B	Black, pack of 50'	10	19	.17"	48'	PK	1
6335G	Green, pack of 50'	10	19	.17"	48'	PK	1
6335R	Red, pack of 50'	10	19	.17"	48'	PK	1
6335W	White, pack of 50'	10	19	.17"	48'	PK	1
6360B	Black, pack of 50'	8	19	.22"	25'	PK	1
6360R	Red, pack of 50'	8	19	.22"	25'	PK	1
6360W	White, pack of 50'	8	19	.22"	25'	PK	1

WIRE cont'd

Thermostat Wire*

Thermoplastic insulated, jacketed wire for low voltage applications. Conductors are solid copper, individually insulated and color coded.



CATALOG NO.	DESCRIPTION	CONDUCTORS	WIRE GAUGE	LENGTH	UOM	ORDER MULTIPLE
6331	Thermostat Wire, pack of 40'	2	20	40'	PK	1
6336	Thermostat Wire, pack of 40'	3	20	40'	PK	1
6330-4	Thermostat Wire, pack of 40'	4	20	40'	PK	1
6337	Thermostat Wire, pack of 40'	5	20	40'	PK	1
6330-6	Thermostat Wire, pack of 40'	6	20	40'	PK	1
6338	Thermostat Wire, pack of 40'	8	20	40'	PK	1
6339XL	Thermostat Wire, pack of 40'	10	20	40'	PK	1

High Temperature Range Wire*

200°C glass braided, three conductor twisted wire. 600V; silicone rubber insulated. This product also contains a crimper.



CATALOG NO.	COLOR	WIRE GAUGE	LENGTH	UOM	ORDER MULTIPLE
6383-35	Black, Red, and White, pack of 5'	14	5'	PK	1
6383-325	Black, Red, and White, pack of 25'	14	25'	PK	1
6384-35	Black, Red, and White, pack of 5'	12	5'	PK	1
6384-325	Black, Red, and White, pack of 25'	12	25'	PK	1

SJTO Service Cord*

Features stranded bare copper, PVC insulation; PVC jacket. Cord is oil resistant. Cords have 3 individually insulated conductors. Ratings: 300V; 60°C.

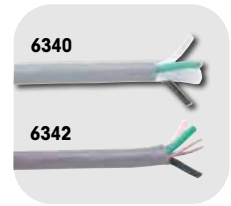

CATALOG NO.	DESCRIPTION	WIRE GAUGE	LENGTH	UOM	ORDER MULTIPLE
6340	SJTO Service Cord, pack of 12'	16	12'	PK	1
6341	SJTO Service Cord, pack of 20'	16	20'	PK	1
6342	SJTO Service Cord, pack of 12'	14	12'	PK	1
6343	SJTO Service Cord, pack of 20'	14	20'	PK	1

Stranded High Temperature Wire*

Thermoplastic equipment insulated wire. CSA listed at 105°C; 600V. Insulation thickness: .03". MTW/AWM/TEW

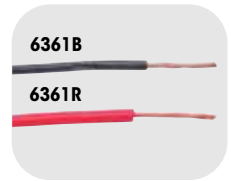

CATALOG NO.	COLOR	GAUGE	STRANDS	O.D.	LENGTH	UOM	ORDER MULTIPLE
6361B	Black, pack of 48'	18	16	.113"	48'	PK	1
6361R	Red, pack of 48'	18	16	.113"	48'	PK	1
6362B	Black, pack of 48'	16	26	.125"	48'	PK	1
6362W	White, pack of 48'	16	26	.125"	48'	PK	1
6363W	White, pack of 48'	14	19	.139"	48'	PK	1
6364B	Black, pack of 48'	12	19	.158"	48'	PK	1
6364R	Red, pack of 48'	12	19	.158"	48'	PK	1
6364W	White, pack of 48'	12	19	.158"	48'	PK	1
6365R	Red, pack of 48'	10	19	.182"	48'	PK	1

WIRING DEVICES

Thermoplastic Handle Plug*

This plug is a standard grade with flexible spring prongs and is furnished with a face washer. This product's rating is a 15A 125V and also contains a crimper.



CATALOG NO.	DESCRIPTION	MAX. CORD DIAMETER	POLES	WIRES	MATERIAL	UOM	ORDER MULTIPLE
ED179	Handle Plug	.406"	2	2	Thermoplastic	EA	1

Grounding Rubber Handle Plug*

The rubber back design allows for sure grip and protection against dirt and moisture entry. This plug is designed to operate in the widest possible temperature ranges.



CATALOG NO.	DESCRIPTION	FITS CORD DIAMETER	POLES	WIRES	RATING	UOM	ORDER MULTIPLE
ED1709	Grounding Handle Plug	.25"-.60"	2	3	15A-125V	EA	1

Tandem Grounding Rubber Handle Plug*

The rubber back design allows for sure grip and protection against dirt and moisture entry. This plug is designed to operate in the widest possible temperature ranges



CATALOG NO.	DESCRIPTION	FITS CORD DIAMETER	POLES	WIRES	RATING	UOM	ORDER MULTIPLE
ED1711	Tandem Handle Plug	.25"-.60"	2	3	15A-250V	EA	1

Armored Plug*

This plug has a round dead front and is vinyl enclosed.



CATALOG NO.	DESCRIPTION	FITS CORD DIAMETER	POLES	WIRES	RATING	UOM	ORDER MULTIPLE
ED2867	Armored Plug	.25"-.625"	2	3	15A-125V	EA	1



WIRING DEVICES cont'd

Right Angle Plug*

Our right angle plug is ergonomically designed fluted body with radial gripping ridge creates an ideal surface for gripping and pulling.



CATALOG NO.	DESCRIPTION	FITS CORD DIAMETER	POLES	WIRES	RATING	UOM	ORDER MULTIPLE
ED4409	Right Angle Plug	.25"-.655"	2	3	20A-125V	EA	1
ED4509	Right Angle Plug	.25"-.655"	2	3	20A-250V	EA	1
ED4867	Right Angle Plug	.25"-.655"	2	3	15A-125V	EA	1

Rubber Connector*

This is a standard grade rubber connector with a 3 pole opening.



CATALOG NO.	DESCRIPTION	FITS CORD DIAMETER	POLES	WIRES	RATING	UOM	ORDER MULTIPLE
ED252	Rubber Connector	.25"-.60"	2	3	15A-125V	EA	1

Armored Connector*

The Armor Connector is ideal for shops, garages, and heavier duty work areas. Vinyl enclosed.



CATALOG NO.	DESCRIPTION	FITS CORD DIAMETER	POLES	WIRES	RATING	UOM	ORDER MULTIPLE
ED2887	Armored Connector	.225"-.60"	2	3	15A-125V	EA	1

Ground Adapter*

This adapter is polarized with 2 pole to 3 wire grounding. The body is made of polypropylene.



CATALOG NO.	DESCRIPTION	RATING	UOM	ORDER MULTIPLE
ED419	Ground Adapter	15A-125V	EA	2

Triple Outlets*

These outlets are polarized and are made of high impact resistant plastic.



CATALOG NO.	DESCRIPTION	RATING	UOM	ORDER MULTIPLE
5223	Heavy duty, 2 pole, 3 wire	15A-125V	EA	1

Power Supply Replacement Cords*

For power tools or appliances. Black vinyl cord is flexible in very cold environments. Wire type is SJEW-A.



CATALOG NO.	DESCRIPTION	WIRE	RATING	LENGTH	UOM	ORDER MULTIPLE
5240	Black Replacement Cord	16/3	13A/125V	10'	EA	1
5242	Black Replacement Cord	14/3	15A/125V	10'	EA	1

Receptacles*

Our receptacles are available in either singles or duplexes. This is a 2 pole, 3 wire product with ground included. Standard Grade.



CATALOG NO.	DESCRIPTION	RATING	COLOR	UOM	ORDER MULTIPLE
ED1876	Single Receptacle	20A-250V	Brown	EA	1
ED1876-I	Single Receptacle	20A-250V	Ivory	EA	1
ED1877	Single Receptacle	20A-125V	Brown	EA	1
ED270**	Duplex Receptacle	15A-125V	Brown	EA	1
ED270-I**	Duplex Receptacle	15A-125V	Ivory	EA	1
ED877	Duplex Receptacle	20A-125V	Brown	EA	1

**Standard Grade

Toggle Switch and Receptacle Combination Device*

This device is a single pole switch with 15A 120V AC. The receptacle is 15A 125V AC and it is a 2 pole, three wire grounding.



CATALOG NO.	DESCRIPTION	UOM	ORDER MULTIPLE
ED5225	Toggle Switch and Receptacle - Brown Body	EA	1

*Items in this section are Underwriter's Laboratories listed or recognized under the prime manufacturer's name.

WIRING DEVICES cont'd

Metal Bat Handle Toggle Switches*

Features black phenolic plastic case; brass terminals; steel and zinc chromate frame and support; all other external parts are brass/bright nickel. These heavy duty toggle switches have screw terminals. Part ED447 has an "ON-OFF" face plate.

Specifications: 10A/277V–20A/125V AC
Single Pole: 3/4HP 125–250V AC
Double Pole: 1-1/2HP 125–250V AC

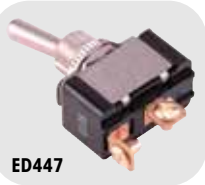

ED447

CATALOG NO.	DESCRIPTION	SEQUENCE	CIRCUIT	UOM	ORDER MULTIPLE
ED447	Bat Handle Toggle Switch	ON-OFF	Single Pole, Single Throw	EA	1
ED453	Bat Handle Toggle Switch	ON-ON	Double Pole, Double Throw	EA	1
ED454	Bat Handle Toggle Switch	ON-ON	Single Pole, Double Throw	EA	1
ED455	Bat Handle Toggle Switch	ON-OFF	Double Pole, Single Throw	EA	1
ED468	Bat Handle Toggle Switch	ON-OFF-ON	Single Pole, Double Throw	EA	1
ED494	Bat Handle Toggle Switch	ON-OFF-ON	Double Pole, Double Throw	EA	1
ED448B	Bat Handle Toggle Switch	ON-OFF	Single Pole, Single Throw	EA	1

Toggle Switch with Neon Pilot Light Combination Device*

Switch: 15A-120V AC
Neon Pilot Light: 1/25W, 120V AC



ED277

CATALOG NO.	DESCRIPTION	UOM	ORDER MULTIPLE
ED277	Toggle Switch with Neon Pilot Light – Brown Body	EA	1

Utility Fuse Outlets*

This is designed to break up electrical surges on equipment.



PI381

CATALOG NO.	DESCRIPTION	UOM	ORDER MULTIPLE
PI381	Utility Fuse Outlet and Switch with Cover; 1/2HP-125V AC only; galvanized steel construction	EA	1

6180 Series Terminal Blocks*

These terminal blocks are constructed of high barrier thermoplastic are rated 20A 250V.



6182

CATALOG NO.	DESCRIPTION	NO. OF POSITIONS	LENGTH (in.)	WIDTH (in.)	SCREW SIZE	MAX. WIRE SIZE	UOM	ORDER MULTIPLE
6182	Terminal Block	4	2.16	.88	6-32	22-14	EA	1
6183	Terminal Block	6	2.91	.88	6-32	22-14	EA	1
6184	Terminal Block	8	3.66	.88	6-32	22-14	EA	1
6185	Terminal Block	10	4.41	.88	6-32	22-14	EA	1
6186	Terminal Block	12	5.16	.88	6-32	22-14	EA	1
6187	Terminal Block	14	5.91	.88	6-32	22-14	EA	1

Toggle Switches*

Our toggle switch is a silent switch with ground included. Standard Grade.

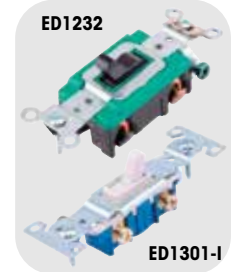

ED1232

ED1301-I

CATALOG NO.	DESCRIPTION	RATING	COLOR	UOM	ORDER MULTIPLE
ED1240-2	Single Pole	15A–120/277V AC	Brown	EA	1
ED1238	Single Pole	20A–120/277V AC	Brown	EA	1
ED1301**	Single Pole	15A–120V AC	Brown	EA	1
ED1301-I**	Single Pole	15A–120V AC	Ivory	EA	1
ED1262-2	Double Pole	15A–120/277V AC	Brown	EA	1
ED1262-2I	Double Pole	15A–120/277V AC	Ivory	EA	1
ED1232	Double Pole	30A–120/277V AC	Brown	EA	1

**Standard Grade

Porcelain Outlet Box Lampholders*

Features one-piece pull chain. Two screw terminals, 2 pole, 2 wire. 4-1/2" outer diameter. These lamp- holders fit 3-1/4" and 4" boxes. Rating: Lampholder: 660W/125V. Outlet: 15A/125V.



ED9726

CATALOG NO.	DESCRIPTION	UOM	ORDER MULTIPLE
ED9726	Porcelain Outlet Box Lampholder – U ground outlet	EA	1

Fuse Holders

Used to mount and protect fuses, fuse holders also enable fuses to be changed quickly and easily. Fuse holders are used in a variety of applications, including consumer electronics, industrial, telecom and datacom, automotive, and many others.

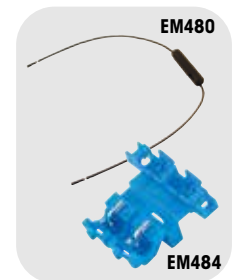

EM480

EM484

CATALOG NO.	DESCRIPTION	UOM	ORDER MULTIPLE
EM480	In-Line Fuse Holder for use with 1-1/4 x 1/4" fuses up to 20 amps, 32 volts, 15" lead; 14 gauge red vinyl insulated wire	EA	1
EM484	Self-Stripping Fuse Holder mates with blade-type fuse .205 x .025". 18-14 AWG. Size: 1.37" L x .44" H x .95" W Max. Insulation Outer Diameter: .145"	EA	2

*Items in this section are Underwriter's Laboratories listed or recognized under the prime manufacturer's name.



WIRING DEVICES cont'd

Vinyl Grommet Assortment Packs

These grommets exhibit high dielectric strength and are oil, ozone, and UV resistant.



CATALOG NO.	DESCRIPTION	UOM	ORDER MULTIPLE
ED320	General Assortment – contains all grommet sizes	EA	1

Heat Shrink Tubing Assortments*

Heat Shrink Tubing is made of flame-retardant polyolefin. Thin walled, all purpose tubing. Rated 600V, 125°C. 2500 volts/mil. dielectric strength. Inert to fungus. Virtually unaffected by corrosives, common fluids, and solvents. Pieces are 6" in length.



CATALOG NO.	COLOR	INNER DIAMETER		UOM	ORDER MULTIPLE
		MAX SUPPLIED	MIN. RECOVERED		
6370	Black & White, pack of 12	1/8", 1/4"	1/16", 1/8"	PK	1
6371	Black & White, pack of 7	1/8", 1/4", 3/8"	1/16", 1/8", 3/16"	PK	1
63070	Black, pack of 3	3/8" – 1/2"	3/16" – 1/4"	PK	1

Indicator Lights

Terminals are tin plated brass. Wire leads are 22 AWG, 4.4"–4.8" long, 1/2" stripped. Mounting will snap-fit into .500-.505 diameter hole in .020"-.100" thick panels.



CATALOG NO.	LENS COLOR	LENS MATERIAL	VOLTAGE	BULB TYPE	UOM	ORDER MULTIPLE
ED600	Red, pack of 2	Polycarbonate	28V	Incandescent	PK	1
ED601	Green, pack of 2	Polycarbonate	28V	Incandescent	PK	1
ED602	Amber, pack of 2	Polycarbonate	28V	Incandescent	PK	1
ED603	Blue, pack of 2	Polycarbonate	28V	Incandescent	PK	1
ED610	Red, pack of 2	Nylon	105–125V AC	Neon	PK	1
ED611	Green, pack of 2	Polycarbonate	105–125V AC	Neon**	PK	1
ED612	Amber, pack of 2	Nylon	105–125V AC	Neon	PK	1
ED613	Blue, pack of 2	Polycarbonate	105–125V AC	Neon†	PK	1
ED620	Red, pack of 2	Polycarbonate	208–250V AC	Neon	PK	1
ED621	Green, pack of 2	Polycarbonate	208–250V AC	Neon**	PK	1

6190 Series Terminal Blocks*

These terminal blocks are constructed of phenolic 9/16 in. centers. They are rated 30A 600V.



CATALOG NO.	DESCRIPTION	NO. OF POSITIONS	LENGTH (in.)	WIDTH (in.)	SCREW SIZE	MAX. WIRE SIZE	UOM	ORDER MULTIPLE
6193	Terminal Block	6	4.34	1.31	8-32	14-12	EA	1
6194	Terminal Block	8	5.47	1.31	8-32	14-12	EA	1
6195X	Terminal Block	10	6.59	1.31	8-32	14-12	EA	1

Indicator Lights*

Terminals are tin plated brass. Wire leads are 22 AWG, 4.4"–4.8" long, 1/2" stripped. .31" minimum diameter mounting.



CATALOG NO.	LENS COLOR	LENS MATERIAL	VOLTAGE	BULB TYPE	UOM	ORDER MULTIPLE
ED710	Red, pack of 2	Polycarbonate	105–125V AC	Neon	PK	1

Winged Wire Connectors*

Durable thermoplastic material. Flame retardant, abrasion resistant, non porous, and non corrosive. Expandable spring grips into the wire and adjusts itself to the wire size and shape so pre twisting is unnecessary. Even during temperature changes, they resist vibrations and retain holding power. Parts 8284 and 8286 are for use with copper to copper, aluminum to aluminum, and copper to aluminum (dry locations only).



CATALOG NO.	DESCRIPTION	UOM	ORDER MULTIPLE
8284	Small Yellow Winged Wire Connectors, pack of 18	PK	1
8284CX-B	Small Yellow Winged Wire Connectors, pack of 100	PK	1
8286	Medium Red Winged Wire Connectors, pack of 14	PK	1
8286CX-B	Medium Red Winged Wire Connectors, pack of 100	PK	1
8282LX	X-Large Blue Winged Wire Connectors, pack of 50	PK	1

-B indicates boxed product. All other catalog numbers are poly bagged.

*Items in this section are Underwriter's Laboratories listed or recognized under the prime manufacturer's name.



WIRING DEVICES cont'd

Standard Wire Connectors*

Connectors are color coded with spring inserts. Heat resistant (105°C) thermoplastic. Connectors are for copper to copper connections. Parts 6294 and 6296 can connect aluminum to aluminum and copper to aluminum (dry locations only).

6292



CATALOG NO.	DESCRIPTION	UOM	ORDER MULTIPLE
6291	Mini Gray Standard Wire Connectors, pack of 29	PK	1
6291CX	Mini Gray Standard Wire Connectors, pack of 100	PK	1
6292	Tiny Blue Standard Wire Connectors, pack of 25	PK	1
6292CX	Tiny Blue Standard Wire Connectors, pack of 100	PK	1
6293	Small Orange Standard Wire Connectors, pack of 20	PK	1
6293CX	Small Orange Standard Wire Connectors, pack of 100	PK	1
6294	Medium Yellow Standard Wire Connectors, pack of 18	PK	1
6294CX	Medium Yellow Standard Wire Connectors, pack of 100	PK	1
6296	Large Red Standard Wire Connectors, pack of 12	PK	1
6296CX	Large Red Standard Wire Connectors, pack of 100	PK	1
6298	X-Large Gray Standard Wire Connectors, pack of 6	PK	1
6298LX	X-Large Gray Standard Wire Connectors, pack of 50	PK	1
6295X	Assortment: Includes 6291, 6292, 6293, 6294, 6296	EA	1

Aluminum Solderless Lugs*

Our aluminum solder less lug are made from high strength aluminum alloy. These lugs are suitable for use with either copper or aluminum conductors.



PI221

CATALOG NO.	DESCRIPTION	WIRE RANGE	AMP RATING	UOM	ORDER MULTIPLE
PI221	Small Lug for aluminum or copper wire, pack of 6	4-14	2	PK	1
PI222	Large Lug for aluminum or copper wire, pack of 6	2-14	2	PK	1

Pigtails

The wire has a #10 spade on one end and a 10 32 x 3/8in. slotted round head screw on the other. This allows for easy positioning in the outlet box.

PI337-3

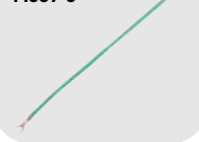

CATALOG NO.	DESCRIPTION	WIRE LENGTH	WIRE GAUGE	WIRE TYPE	UOM	ORDER MULTIPLE
PI337-3	Pigtails, pack of 5	8"	14	Stranded	PK	1

Cable Markers

Cable markers come in books of 450 markers with matching terminal markers. Markers are mounted on dispenser cards in the book. Cable markers are suitable for above and below ground applications. Books are made of vinyl impregnated cloth that resists moderate amounts of dirt, oil and heat. The blank Write-On Markers (WM1014) are made of durable vinyl film that resists water, oils, and fungus. They can also withstand extremes in temperature.



WM1002

CATALOG NO.	DESCRIPTION	UOM	ORDER MULTIPLE
WM1002	Alpha-Numeric Cable Marker Book; contains 10 each: A-Z, 0-15, +, -, /	EA	1
WM1003	Numeric Cable Marker Book; contains 10 each: 1-45	EA	1
WM1009	Line and Terminal Cable Marker Book; contains 45 each: 1, 2, 3, A, B, C; contains 30 each: T1, T2, T3, L1, L2, L3	EA	1
WM1014	180 Blank Write-On Markers, 1/2" x 1-1/2"	EA	1

Porcelain Wire Connectors*

For high temperature applications over 105°C (300 volts maximum). For stranded copper connections only.

4293



CATALOG NO.	DESCRIPTION	UOM	ORDER MULTIPLE
4293	Small White Porcelain Wire Connectors, pack of 17	PK	1
4293CX	Small White Porcelain Wire Connectors, pack of 100	PK	1
4294	Medium White Porcelain Wire Connectors, pack of 15	PK	1
4294CX	Medium White Porcelain Wire Connectors, pack of 100	PK	1
4296	Large White Porcelain Wire Connectors, pack of 13	PK	1
4296CX	Large White Porcelain Wire Connectors, pack of 100	PK	1

Electrolytic Copper Solderless Lugs*

Our solder less lugs are manufactured from high strength pure electrolytic copper to insure both maximum strength and conductivity.

PI227



CATALOG NO.	DESCRIPTION	WIRE RANGE	AMP RATING	UOM	ORDER MULTIPLE
PI227	Medium Lug for copper wire, pack of 6	6-14	35-50	PK	1
PI228	Large Lug for copper wire, pack of 6	4-14	70	PK	1

Split Bolt Connectors*

These connectors are made of silicone bronze and are designed for copper use only.

PI327



CATALOG NO.	DESCRIPTION	MAX. SOLID WIRE	MAX. STRANDED WIRE	UOM	ORDER MULTIPLE
PI326	Split Bolt Connector, pack of 3	10	12	PK	1
PI327	Split Bolt Connector, pack of 3	8	8	PK	1
PI328	Split Bolt Connector, pack of 3	6	7	PK	1
PI929	Split Bolt Connector, pack of 3	4	5	PK	1

Ground Fitting Clamp*

A ground fitting clamp is ideal for surface mounting small amounts of electrical wiring or communication cables.

PI237



CATALOG NO.	DESCRIPTION	UOM	ORDER MULTIPLE
PI237	For 8, 6, 4 bare grounding wire; fits 1/2"-1" pipe	EA	1

*Items in this section are Underwriter's Laboratories listed or recognized under the prime manufacturer's name.

**Neon bulb incorporates G2B lamp and resistor.

† Neon bulb incorporates T2B lamp and resistor.

ELECTRICAL

Capacitors.....97-98
 Conduit, Fittings, Cable95-96
 Contactors..... 100-101
 DiversiTech Electrical Disconnects.....94
 Eaton Electrical Disconnects.....95
 Electrical Supplies 106-109
 Electrical Tapes..... 110-111
 Fan Centers..... 103
 Fuses 103-104
 Hard Start Kits 100
 Monitors..... 105
 Motor Brackets 93
 Motor Run Capacitors (USA Made).....99
 Motors88-92
 Relays..... 102
 Stranded Copper THHN Wire..... 115-116
 Surge Protectors 106
 Terminals, Connectors..... 111-112
 Thermal Controls 113
 Thermostat Guards 114
 Thermostat Wire 115
 Thermostats 113
 Time Delays 105
 Transformers 102
 Whips93-94
 Wire Connectors..... 116-117
 Wire/Cable Ties, Mounts, Clamps 117-118



MOTORS

Wagner® Single Speed Condenser Fan Motors

- Installs with all Standard 48 Frame Mounting Brackets
- Standard Shaft Length, Diameter, and Flats
- Drain Holes with Plugs in both end plates
- Automatic Thermal Overload Protector
- Standard 48 Frame Motor Casing Size
- Low Power Consumption
- 60 C Ambient Design
- Electrically Reversible
- Continuous Air Over
- Class B Insulation
- Quiet Operation
- Extended Studs
- 30" Leads
- 60 HZ



BALL BEARINGS NOW STANDARD



CATALOG NO.	HP	VOLTAGE	SPEED	FLA	UOM	ORDER MULTIPLE
WG840727	1/6	208-230	1075/1	1.3	EA	1
WG840728	1/4	208-230	1075/1	2.2	EA	1
WG840729	1/3	208-230	1075/1	2.8	EA	1
WG840730	1/2	208-230	1075/1	4.2	EA	1
WG840731	3/4	208-230	1075/1	4.5	EA	1
WG840203	1/6	208-230	825/1	1.3	EA	1
WG840204	1/4	208-230	825/1	1.5	EA	1
WG840205	1/3	208-230	825/1	2.2	EA	1
WG840746	1/2	208-230	825/1	2.9	EA	1

Wagner® High Temperature Condenser Fan Motors

- 70°C Ambient Temperature
- Installs with all Standard 48 Frame Mounting Brackets
- Standard Shaft Length, Diameter, and Flats
- Drain Holes with Plugs in both end plates
- Automatic Thermal Overload Protector
- Standard 48 Frame Motor Casing Size
- Low Power Consumption
- Electrically Reversible
- Continuous Air Over
- Class B Insulation
- Quiet Operation
- Extended Studs
- 30" Leads
- 60 HZ



BALL BEARINGS NOW STANDARD



CATALOG NO.	HP	VOLTAGE	SPEED	FLA	UOM	ORDER MULTIPLE
WG840727HT	1/6	208-230	1075/1	1.3	EA	1
WG840728HT	1/4	208-230	1075/1	2.2	EA	1
WG840729HT	1/3	208-230	1075/1	2.8	EA	1
WG840730HT	1/2	208-230	1075/1	4.2	EA	1
WG840731HT	3/4	208-230	1075/1	5.3	EA	1
WG840736HT	1/4	460	1075/1	1.65	EA	1
WG840737HT	1/3	460	1075/1	2.85	EA	1
WG840738HT	1/2	460	1075/1	4.3	EA	1
WG840739HT	3/4	460	1075/1	5.3	EA	1
WG840203HT	1/6	208-230	825/1	1.3	EA	1
WG840204HT	1/4	208-230	825/1	1.5	EA	1
WG840205HT	1/3	208-230	825/1	2.2	EA	1
WG840746HT	1/2	208-230	825/1	2.9	EA	1

Wagner® Multiple Horsepower Condenser Fan Motors

The Multi-Horsepower motors are specially designed to cover a range of applications. The condenser fan motors range from 1/2 to 1/5; 1/3 to 1/6 both at 1075 rpm; 1/3 to 1/6 at 825rpm. These motors feature reversing plugs, extended thru bolts 36 inch leads and are designed for 370 volt capacitors. Installs with all 48 frame mounting brackets.



BALL BEARINGS NOW STANDARD



CATALOG NO.	APPLICATION	VOLTAGE	SPEED	(1) HP-FLA	(2) HP-FLA	(3) HP-FLA	(4) HP-FLA	(5) HP-FLA	UOM	ORDER MULTIPLE
WG840458	CF	208-230	1075/1	1/3-2.8	1/4-1.8	1/5-1.7	1/6-1.6	-	EA	1
WG840459	CF	208-230	825/1	1/3-2.1	1/4-1.55	1/5-1.4	1/6-1.34	1/8-1.3	EA	1
WG840465	CF	208-230	1075/2	1/3-2.8	1/4-2.0	1/5-1.7	1/6-1.5	-	EA	1
WG840468	CF	208-230	1075/2	1/2-3.0	1/3-2.5	1/4-2.0	1/5-1.3	-	EA	1
WG840469	CF	208-230	825/2	1/3-2.1	1/4-1.7	1/5-1.5	1/6-1.2	-	EA	1

Wagner® High Temperature Multiple Horsepower Condenser Fan Motors

The Multi-Horsepower motors are specially designed to cover a range of applications. The condenser fan motors range from 1/2 to 1/5; 1/3 to 1/6 both at 1075 rpm; 1/3 to 1/6 at 825rpm. These motors feature reversing plugs, extended thru bolts, 36 inch leads and are designed for 370 volt capacitors. Installs with all 48 frame mounting brackets.



**BALL BEARINGS
NOW STANDARD**



CATALOG NO.	APPLICATION	VOLTAGE	SPEED	(1) HP-FLA	(2) HP-FLA	(3) HP-FLA	(4) HP-FLA	(5) HP-FLA	UOM	ORDER MULTIPLE
WG840465HT	CF	208-230	1075/2	1/3-2.8	1/4-2.0	1/5-1.7	1/6-1.5	-	EA	1
WG840469HT	CF	208-230	825/2	1/3-1.9	1/4-1.7	1/5-1.5	1/6-1.2	-	EA	1
WG840468HT	CF	208-230	1075/2	1/2-3.8	1/3-2.5	1/4-2.0	1/5-1.5	-	EA	1
WG840459HT	CF	208-230	825/1	1/3-2.1	1/4-1.55	1/5-1.4	1/6-1.34	1/8-1.3	EA	1
WG840458HT	CF	208-230	1075/1	1/3-2.8	1/4-1.8	1/5-1.7	1/6-1.6	-	EA	1
WG840884HT	CF	460	825/1	1/3-1.1	1/4-0.82	1/5-0.72	1/6-0.7	1/8-0.68	EA	1

Wagner® Direct Drive Furnace Blower Motors

- Installs with all Standard 48 Frame Mounting Brackets
- Standard Shaft Length, Diameter, and Flats
- Uses 370V Capacitors
- Standard 48 Frame Motor Casing Size
- 2.5" Diameter Hub Rings included
- Low Power Consumption
- Automatic Thermal Overload Protector
- Continuous Duty, Air Over
- Electrically Reversible
- Class B Insulation
- Speed: 1075/3
- Quiet Operation
- 60 HZ

CATALOG NO.	HP	VOLTAGE	SPEED	FLA	UOM	ORDER MULTIPLE
WG840583	1/4	115	1075/3	4.2	EA	1
WG840584	1/4	208-230	1075/3	2.0	EA	1
WG840585	1/3	115	1075/3	5.5	EA	1
WG840586	1/3	208-230	1075/3	2.8	EA	1
WG840587	1/2	115	1075/3	7.5	EA	1
WG840588	1/2	208-230	1075/3	3.6	EA	1
WG840589	3/4	115	1075/3	10.2	EA	1
WG840590	3/4	208-230	1075/3	5.5	EA	1
WG840595	1	115	1075/3	12.6	EA	1
WG840596	1	208-230	1075/3	5.59	EA	1

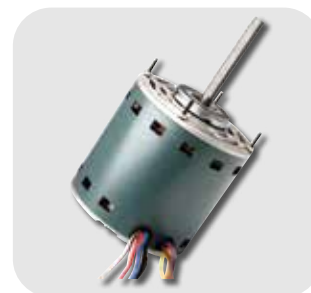

Wagner® Multiple Horsepower Furnace Blower Motors

The Multi-Horsepower motors are specially designed to cover a range of applications. The direct drive furnace blower motors range from 1/2 to 1/6 in both 115 and 230 volts and 3/4 to 1/5 in both 115 and 230 volts all at 1075rpm. These motors feature reversing plugs, extended thru bolts 36 inch leads and are designed for 370 volt capacitors. Installs with all 48 frame mounting brackets.

CATALOG NO.	APPLICATION	VOLTAGE	SPEED	(1) HP-FLA	(2) HP-FLA	(3) HP-FLA	(4) HP-FLA	(5) HP-FLA	UOM	ORDER MULTIPLE
WG840463	DDFB	115	1075/4	1/2-7.0	1/3-6.7	1/4-4.4	1/5-3.2	1/6-2.4	EA	1
WG840464	DDFB	208-230	1075/4	1/2-3.9	1/3-3.6	1/4-2.5	1/5-1.8	1/6-1.3	EA	1
WG840466	DDFB	115	1075/4	3/4-8.1	1/2-6.6	1/3-4.6	1/4-3.8	1/5-3.1	EA	1
WG840467	DDFB	208-230	1075/4	3/4-3.8	1/2-3.7	1/3-2.5	1/4-1.8	1/5-1.7	EA	1

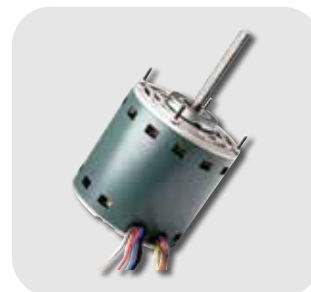

MOTORS cont'd

Evergreen® CM ECM Motors

The Evergreen CM is made with the same field-proven, high-efficiency ECM technology that has been used for more than 20 years in new HVAC equipment. It features flexible control methods to help the installer balance airflow in HVAC systems such as VAV (Variable Air Volume) boxes and Packaged HVAC systems. The Evergreen CM is designed as a direct replacement for OEM (Original Equipment Manufacturer) Genteq model X13 (Constant Torque ECM) or as a field replacement for existing PSC (Permanent Split Capacitor) motors.

CATALOG NO.	HP	VOLTAGE	SPEED	FLA	RPM	SHAFT	UOM	ORDER MULTIPLE
6703CM	1/3	208-230/277	5/PWM	2.8	1075	.5"X4" (3.5" SF)	EA	1
6705CM	1/2	208-230/277	5/PWM	4.1	1075	.5"X4" (3.5" SF)	EA	1
6707CM	3/4	208-230/277	5/PWM	6.0	1075	.5"X4" (3.5" SF)	EA	1
6710CM	1	208-230/277	5/PWM	7.6	1075	.5"X4" (3.5" SF)	EA	1
6405CM	1/2	460	5/PWM	2.1	1075	.5"X4" (3.5" SF)	EA	1
6407CM	3/4	460	5/PWM	3.2	1075	.5"X4" (3.5" SF)	EA	1
6410CM	1	460	5/PWM	4.0	1075	.5"X4" (3.5" SF)	EA	1

6703CM



Evergreen® EM ECM Motors

The Evergreen EM was designed to replace direct-drive blower motors in residential and light commercial indoor furnaces, air handlers and package systems that were designed with a standard ECM motor, such as X13 or equivalent competitor model. It can also be used to retrofit PSC motors in commercial building series VAV boxes and packaged heat pump systems. It is NOT intended to replace premium ECM constant airflow products, such as EON, 2.3, 3.0 and 2.5.

CATALOG NO.	HP	VOLTAGE	SPEED	FLA	RPM	SHAFT	UOM	ORDER MULTIPLE
6103E	1/3	115	5/PWM	4.8	1075	.5" X 5" (4.5" SF)	EA	1
6105E	1/2	115	5/PWM	6.8	1075	.5" X 5" (4.5" SF)	EA	1
6107E	3/4	115	5/PWM	8.4	1075	.5" X 5" (4.5" SF))	EA	1
6110E	1	115	5/PWM	10.9	1075	.5" X 5" (4.5" SF)	EA	1
6203E	1/3	208/230	5/PWM	2.8	1075	.5" X 5" (4.5" SF)	EA	1
6205E	1/2	208/230	5/PWM	4.1	1075	.5" X 5" (4.5" SF)	EA	1
6207E	3/4	208/230	5/PWM	6.0	1075	.5" X 5" (4.5" SF)	EA	1
6210E	1	208/230	5/PWM	7.6	1075	.5" X 5" (4.5" SF)	EA	1

6103E



Evergreen® IM ECM Motors

The Evergreen IM is an ECM designed to replace an existing PSC (Permanent Split Capacitor), direct drive, indoor blower motor. It is constructed with more than 20 years of proven ECM technology and reliability.

CATALOG NO.	HP	VOLTAGE	SPEED	FLA	RPM	SHAFT	UOM	ORDER MULTIPLE
6005	1/2 (1/2, 1/3, 1/4)	115/230	5	6.7/4.0	1075	.5" X 5" (4.5" SF)	EA	1
6010	1 (1, 3/4, 1/2)	115/230	5	11.0/6.7	1075	.5" X 5" (4.5" SF)	EA	1

6005



Evergreen® OM ECM Motors

The Evergreen Outdoor Motor, also known as Evergreen OM, is designed for direct-drive fan propeller applications in residential systems up to 5-tons. Easily replaces 6 Pole (1,100 rpm rated) and 8 pole (850 rpm rated) shaded pole or PSC motors.

CATALOG NO.	HP	VOLTAGE	SPEED	FLA	RPM	SHAFT	UOM	ORDER MULTIPLE
6301	1/5	208-240	2	2.8	850/1100	.5" X 3" (2.5" SF)	EA	1
6303	1/3	208-240	2	3.5	850/1100	.5" X 3" (2.5" SF)	EA	1
6903	1/3	460	2/PWM	1.6	850/1100	.5" X 6" (5.5" SF)	EA	1
6905	1/2	460	2/PWM	2.5	850/1100	.5" X 6" (5.5" SF)	EA	1
6907	3/4	460	2/PWM	3.1	850/1100	.5" X 6" (5.5" SF)	EA	1



Evergreen® PF ECM Motors

The Evergreen PF is a drop-in replacement or proactive upgrade for pedestal and wall mount fan motors in warehouses, factory floors, amusement parks, institutional buildings and other similar applications. With a rated efficiency of up to 82% and three operating speeds, Evergreen PF makes is easy to provide energy savings and reduce operating noise. It is easy for retrofit as it comes with a power cord, switch and welded mount. The Evergreen PF also includes a pull chain for easy speed selection from 1160/970/650 operating speeds.

CATALOG NO.	HP	VOLTAGE	SPEED	FLA	RPM	SHAFT	UOM	ORDER MULTIPLE
6803	1/3	115	3	5.8	1160/970/650	.5" X 3" (2.5" SF)	EA	1



Evergreen® InTune™ Programmer for ECM Motors

InTune is two components - a WIFI programmer (catalog #5K006) that connects in series with the motors existing connections and a free app. The WIFI programmer is purchased once and re-used on each motor during the tuning process. Free apps are available at the App Store and Google Play.

CATALOG NO.	Description	UOM	ORDER MULTIPLE
5K006	Evergreen InTune™ WIFI Programmer	EA	1



MOTORS cont'd

Fasco® OEM Replacement Draft Inducers

Designed, engineered and life-tested in the USA by FASCO. OEM approved for aftermarket replacement.

- Performance to match the original design.
- Fit for proper operation of the safety pressure switch and condensate management system.
- UL recognized, CSA or cUL certified.
- Safety for your customers and your business.



CATALOG NO.	HP	VOLTAGE	SPEED	AMPS	TYPE	RPM	ROT.	BRNG.	FRAME	OEM CROSS REFERENCE	UOM	ORDER MULTIPLE
AMANA												
A129	1/20	115	1	1.95	SP	3250	CW	SLV	3.3	Amana, 7021-9064, 7021-9259	EA	1
ARMSTRONG												
A155	1/30	115	1	1.4	SP	3000	CCW	BALL	3.3	7021-10046	EA	1
GOODMAN												
A140	1/50	115	1	1.4	SP	3400	CW	SLV	3.3	7021-9087, 7021-9000	EA	1
A157	1/35	115	1	1.3	SP	3000	CCW	SLV	-	7002-2307	EA	1
A182	1/35	115	1	1.2	SP	3125	CCW	SLV	3.3	7002-3036, B4059000	EA	1
INTERCITY PRODUCTS												
A051	1/60	115	1	1.6	SP	3000	CW	BALL	-	1013833, J238-1393	EA	1
A067	1/20	115	1	2.6	SP	3000	CW	BALL	3.3	1014338 119225-00	EA	1
A134	1/25	115	1	1.5	SP	3060	CW	SLV	3.3	7021-9335, 7021-8735, 7021-9499, 7021-8736	EA	1
A169	1/25	230	1	0.75	SP	2800	CW	SLV	3.3	7021-10048, 7021-10580	EA	1
A170	1/25	115	1	2.3	SP	3400	CCW	BALL	3.3	7021-10702, 7021-10299	EA	1
A171	1/25	115	1	0.7	PSC	3450	CCW	BALL	3.3	7062-4783, 1011412	EA	1
A172	1/35	115	1	1.6	SP	3000	CW	BALL	-	7002-2792, 1010975P	EA	1
A173	1/18	115	1	0.8	PSC	3450	CCW	BALL	3.3	7062-4578, 1011350	EA	1
JANITROL												
A079	1/50	115	1	1.1	SP	3000	CCW	SLV	3.3	7062-6804	EA	1
JOHNSON FURNACE												
A081'	1/40	230	1	0.5	SP	3000	CCW	BALL	3.3	HWC Series Unit	EA	1
LENNOX												
A163	1/20	115	1	1.8	SP	3400	CCW	BALL	3.3	7021-9450	EA	1
A200	1/30	115	1	1.95	SP	3000	CCW	BALL	-	7002-2975, 31L5501	EA	1
A202	1/30	115	1	1.8	SP	3400	CCW	BALL	3.3	7021-10602, 45037-001	EA	1
A213	1/25	115	2	2.1	SP	3200	CCW	BALL	3.3	7021-10376, 18L0401	EA	1
RHEEM-RUUD												
A066	1/30	120	1	1.27	SP	3000	CW	BALL	3.3	70-24157-03, 117847-00	EA	1

All rotation is determined by looking at shaft end.
 Note: 1. 3-1/2" motor body length

MOTOR BRACKETS

DiversiTech® Motors Bracket

These brackets help hold the motor securely.



CATALOG NO.	DESCRIPTION	UOM	ORDER MULTIPLE
DMB-1	Fixed Lug Assembly for 5-1/2" diameter motors	EA	1
DMB-2	Adjustable Lug Assembly for 5-1/2" diameter motors	EA	1

Motor Mount – Flex Bracket

Torsion Flex Bracket holds motor securely. Fits 5-1/2" motors. Typically used for Goodman equipment.



CATALOG NO.	DESCRIPTION	UOM	ORDER MULTIPLE
DMB-3	5-1/2" Motor Mount Torsion Flex Bracket	EA	1

WHIPS

DiversiWhips

Liquid tight flexible conduit system. A labor saving convenience kit for A/C unit hookup. Also use for heat pumps, refrigeration, hot tubs, swimming pools and outdoor lighting. Three distinct wire colors for ease of hookup. 1 straight and 1 90 degree metallic or non metallic connector. 90 degree connector is removable for straight connections. (Second straight connector not included.) U.L. and C.U.L. Listed.



CATALOG NO.	DESCRIPTION	UOM	ORDER MULTIPLE
6-12-4	1/2" x 4' #10 THHN Wire – Metallic Connectors	EA	6
6-12-6	1/2" x 6' #10 THHN Wire – Metallic Connectors	EA	6
6-34-4	3/4" x 4' #8 THHN Wire – Metallic Connectors	EA	6
6-34-6	3/4" x 6' #8 THHN Wire – Metallic Connectors	EA	6
6-34-8	3/4" x 8' #8 THHN Wire – Metallic Connectors	EA	3
6-12-4NM	1/2" x 4' #10 THHN Wire – Non-Metallic Connectors	EA	6
6-12-6NM	1/2" x 6' #10 THHN Wire – Non-Metallic Connectors	EA	6
6-34-4NM	3/4" x 4' #8 THHN Wire – Non-Metallic Connectors	EA	6
6-34-6NM	3/4" x 6' #8 THHN Wire – Non-Metallic Connectors	EA	6
6-34-8NM	3/4" x 8' #8 THHN Wire – Non-Metallic Connectors	EA	3
6-12-6NMS	1/2" x 6' #10 THHN Wire – 2 Non-Metallic Straight Connectors	EA	6
6-34-6NMS	3/4" x 6' #8 THHN Wire – 2 Non-Metallic Straight Connectors	EA	6
6-12-6NM-2	1/2" x 6' #10 THHN Wire, 2-piece Non-Metallic Connectors	EA	6
6-34-6NM-2	3/4" x 6' #8 THHN Wire, 2-piece Non-Metallic Connectors	EA	6

*For DiversiWhips produced with 2 straight connectors, add S to part number (ex: 6-12-4S).

DiversiWhips Pallet Packs

DiversiWhips are now available in a convenient, bulk packaged pallet pack at a discounted price. Pallet pack makes an attractive floor standing display. 1 straight and 1 90 degrees metallic or non metallic connector.



CATALOG NO.	DESCRIPTION	UOM	ORDER MULTIPLE
B6-12-4	1/2 x 4' #10 THHN Wire – Metallic Connectors	EA	90
B6-12-6	1/2 x 6' #10 THHN Wire – Metallic Connectors	EA	60
B6-34-6	3/4 x 6' #8 THHN Wire – Metallic Connectors	EA	45
B6-12-4NM	1/2 x 4' #10 THHN Wire – Non-Metallic Connectors	EA	90
B6-12-6NM	1/2 x 6' #10 THHN Wire – Non-Metallic Connectors	EA	60
B6-34-4NM	3/4 x 4' #8 THHN Wire – Non-Metallic Connectors	EA	60
B6-34-6NM	3/4 x 6' #8 THHN Wire – Non-Metallic Connectors	EA	45

DiversiWhips with Extended Length Wires

DiversiWhips are available with extra long lead wires for those difficult to wire applications. These whips offer 10in. of lead wire on the straight side and 18in. of lead wire on the 90 degree side.



CATALOG NO.	DESCRIPTION	UOM	ORDER MULTIPLE
6-12-6NMR	1/2 x 6' #10 THHN Wire – Non-Metallic Connectors	EA	6
6-34-6NMR	3/4 x 6' #8 THHN Wire – Non-Metallic Connectors	EA	6

WHIPS cont'd

DiversiWhip - Up to 30 Amp

An economical whip for applications up to 30 Amp. A labor saving convenience kits for A/C hookup, heat pumps, refrigeration, hot tubs, swimming pools and outdoor lighting. One straight and one 90 degree non-metallic connector included.



6-12-6NMP

CATALOG NO.	DESCRIPTION	UOM	ORDER MULTIPLE
6-12-6NMP	1/2" x 6' #12 THHN Wire – Non-Metallic Connectors, Up to 30 Amp	EA	6

DiversiWhips for the Swimming Pool Industry

A labor saving kit for hookup of swimming pool motors, pumps, filters, and timers. Three distinct wire colors for ease of hookup. 1 straight and 1 90 degree non-metallic connector included.



6-12-4NMSWP

CATALOG NO.	DESCRIPTION	UOM	ORDER MULTIPLE
6-12-4NMSWP	1/2" x 4' #10 THHN Wire – In Box	EA	6
6-12-6NMSWP	1/2" x 6' #10 THHN Wire – In Box	EA	6
6-34-4NMSWP	3/4" x 4' #8 THHN Wire – In Box	EA	6
6-34-6NMSWP	3/4" x 6' #8 THHN Wire – In Box	EA	6

Solid Wire Whips

CATALOG NO.	DESCRIPTION	UOM	ORDER MULTIPLE
6-12-4NMSWP	1/2" x 4' #12 Solid 3 Wire – Non-Metallic Conn.	EA	6
6-12-6NMSWP	1/2" x 6' #12 Solid 3 Wire – Non-Metallic Conn.	EA	6
6-12-8NMSWP	1/2" x 8' #12 Solid 3 Wire – Non-Metallic Conn.	EA	3

DIVERSITECH ELECTRICAL DISCONNECTS

Disconnects—Metal Case

Fused model designed with fuses in pull out handle for easy replacement. The line, load, and ground terminals are aligned for ease of wiring. This product has a reversible door which opens to either the left or right. The side open door opens more than 180 degrees for maximum access and has a full dead front. The fused models have indicator lights for blown fuses. This is rain tight and sleet resistant. The UL Listed number is IRF9, NEMA Type 3R and the US Patent is 6,630,637.



DDS-60

CATALOG NO.	DESCRIPTION	UOM	ORDER MULTIPLE
DDS-30	30A Fusible Disconnect Switch	EA	10
DDS-60	60A Fusible Disconnect Switch	EA	10
DDS-60U	60A Non-Fusible Disconnect Switch	EA	10

Low Profile Disconnects—Metal Case

This low profile disconnect switch is a slightly smaller design than that of the standard DiversiTech disconnects. This has a side opening door with a full dead front. This is rain tight and sleet resistant. The UL Listed number is IRF9, NEMA Type 3R.



EDS-60U

EDS-12-6NM

CATALOG NO.	DESCRIPTION	UOM	ORDER MULTIPLE
EDS-60U	60A Non-Fusible Disconnect Switch	EA	10
EDS-12-6NM	Disconnect and Whip Combo Kit	EA	3

Disconnects—Non-Metallic Case

This 60 amp non-fusible disconnect is housed in a lightweight, non-metallic case. It features a side opening door with more than 180° access, full dead front, and a locking tab.



750-P60NF

CATALOG NO.	DESCRIPTION	UOM	ORDER MULTIPLE
750-P60NF	60A Non Fusible Disconnect Switch, Non-Metallic Case, Plastic	EA	10

Molded Case Switch Disconnect

The DDS-60SW Molded Case Switch Disconnect is rugged and easy to use like an ordinary light switch. It eliminates the pullout handle used in traditional AC disconnects and is easy to install. It is UL listed and rated for indoor and outdoor applications with NEMA 3R rating.



DDS-60SW

CATALOG NO.	DESCRIPTION	UOM	ORDER MULTIPLE
DDS-60SW	Molded Case Switch Disconnect, 60A 240 VAC	EA	10

3 Pole Switch for Mini-Splits

Three-pole, 30 Amp, 600 Volt rated disconnect switch provides safe, reliable manual ON/OFF switching control for Mini-splits and HVAC systems. This switch meets the local code requirements of breaking both the power lines (L1 and L2) and the communication line of the mini-split's indoor unit for service.



755-303SW

CATALOG NO.	DESCRIPTION	UOM	ORDER MULTIPLE
755-303SW	3 Pole Switch for Mini-Splits	EA	1

EATON ELECTRICAL DISCONNECTS

Eaton Switch A/C Disconnect

This A/C Disconnect is 60 amps switch rated for 10 HP motors at 240VAC. The switch is an on off circuit breaker with no pull out head that could be lost or stolen. It has easy-to-remove front cover with no screws or fasteners to remove.



DPB222R



CATALOG NO.	DESCRIPTION	UOM	ORDER MULTIPLE
DPB222R	60A molded case switch	EA	1

Eaton Three Phase Disconnects

These disconnects are UL listed and meet UL 98 for enclosed switches and NEMA Std. KS-1. They are suitable as service entrance equipment when applied with neutral or ground lug kit. They come with rainproof NEMA 3R enclosure.



DG322NRB



CATALOG NO.	DESCRIPTION	UOM	ORDER MULTIPLE
DG321NRB	Fusible 30 Amp, 240VAC	EA	1
DG322NRB	Fusible 60 Amp, 240VAC	EA	1
DG322URB	Non-fusible 60 Amp, 240VAC	EA	1

CONDUIT, FITTINGS, CABLE

DiversiTech™ Flexible Conduit

For electrical applications: outside, inside and industrial uses including transformer connections, air conditioning and heating. Joins with metallic or non-metallic connectors, easy to cut. Impact resistant, chemical resistant, and will not kink. U.L. and C.U.L. Listed. For use as indicated in Article 351 of the 1987 NEC.



750-12100

CATALOG NO.	DESCRIPTION	UOM	ORDER MULTIPLE
750-38100	3/8" x 100' Liquid Tite Conduit – Non-Metallic, 100' per roll	EA	1
750-12100	1/2" x 100' Liquid Tite Conduit – Non-Metallic, 100' per roll	EA	1
750-500	1/2" x 100' Liquid Tite Conduit – Metallic, 100' per roll	EA	1
750-34100	3/4" x 100' Liquid Tite Conduit – Non-Metallic, 100' per roll	EA	1
750-600	3/4" x 100' Liquid Tite Conduit – Metallic, 100' per roll	EA	1
750-10100	1" x 100' Liquid Tite Conduit – Non-Metallic, 100' per roll	EA	1
750-125100	1-1/4" x 100' Liquid Tite Conduit – Non-Metallic, 100' per roll	EA	1
750-1550	1-1/2" x 50' Liquid Tite Conduit – Non-Metallic, 50' per roll	EA	1
750-2050	2" x 50' Liquid Tite Conduit – Non-Metallic, 50' per roll	EA	1
750-10500	1" x 500' Liquid Tite Conduit – Non-Metallic, 500' per roll	EA	1
750-121000	1/2" x 1000' Liquid Tite Conduit – Non-Metallic, 1000' per roll	EA	1
750-34800	3/4" x 800' Liquid Tite Conduit – Non-Metallic, 800' per roll	EA	1

Liquid Tite Connectors

For use with metallic and non metallic liquid tite conduit, Type B. Provides smooth connection, no sharp edges to strip wire. Wiring easily pulled through. U. L. Listed. C.U.L. Listed.



750-MLT50 750-NMLT50

750-NMLT9050

CATALOG NO.	DESCRIPTION	UOM	ORDER MULTIPLE
750-NMLT50	1/2" Non-Metallic Straight Connector	EA	25
750-NMLT4550	1/2" Non-Metallic 45 Degree Elbow Connector	EA	10
750-NMLT9050	1/2" Non-Metallic 90 Degree Elbow Connector	EA	10
750-NMLT75	3/4" Non-Metallic Straight Connector	EA	10
750-NMLT4575	3/4" Non-Metallic 45 Degree Elbow Connector	EA	10
750-NMLT9075	3/4" Non-Metallic 90 Degree Elbow Connector	EA	10
750-NMLT100	1" Non-Metallic Straight Connector	EA	5
750-NMLT90100	1" Non-Metallic 90 Degree Elbow Connector	EA	5
750-MLT50	1/2" Metallic Straight Connector	EA	25
750-MLT9050	1/2" Metallic 90 Degree Elbow Connector	EA	10
750-MLT75	3/4" Metallic Straight Connector	EA	10
750-MLT9075	3/4" Metallic 90 Degree Elbow Connector	EA	10
750-NMLT125	1-1/4" Non-Metallic Straight Connector	EA	1
750-NMLT150	1-1/2" Non-Metallic Straight Connector	EA	10
750-NMLT90125	1-1/4" Non-Metallic 90 Degree Elbow Connector	EA	1
750-NMLT5090-F	1/2" Non-Metallic Adjustable Connector	EA	10
750-NMLT7590-F	3/4" Non-Metallic Adjustable Connector	EA	10
750-TZNMLT200	2" NM Topaz	EA	2
750-TZNMLT150	1-1/2" NM Topaz	EA	5
750-TZNMLT90150	1-1/2" NM Topaz 90 Degree	EA	2
750-TZNMLT125	1-1/4" NM Topaz	EA	5
750-TZNMLT90125	1-1/4" NM Topaz 90 Degree	EA	2
750-TZNMLT100	1" NM Topaz	EA	5
750-TZNMLT90100	1" NM Topaz 90 Degree	EA	5
750-TZNMLT38	3/8" NM Topaz	EA	10
750-TZNMLT9038	3/8" NM Topaz 90 Degree	EA	25
750-TZNMLT9050	1/2" NM Topaz 90 Degree	EA	10
750-TZNMLT9075	3/4" NM Topaz 90 Degree	EA	10

Single Piece Liquid Tite Fittings

Conduit threads onto ferrule and up inside the outer body. An inside taper squeezes down on the outside of conduit for a superior liquid tight seal. The cut portion of the conduit does not show, giving a more finished appearance. Easy to use at a lower cost than regular liquid tite fittings.



750-SLTC9050

750-SLTC50

CATALOG NO.	DESCRIPTION	UOM	ORDER MULTIPLE
750-SLTC50	1/2" Straight Screw-On Fitting	EA	25
750-SLTC9050	1/2" 90° Screw-On Fitting	EA	25
750-SLTC75	3/4" Straight Screw-On Fitting	EA	25
750-SLTC9075	3/4" 90° Screw-On Fitting	EA	25

CONDUIT, FITTINGS, CABLE cont'd

Two-Piece Liquid Tite Fittings

These 2-piece Liquid Tite compression fittings are for use with non-metallic Type B Liquid Tite conduit to terminate and seal conduit to enclosures. Easy to use with no disassembly required, cULus listed.



CATALOG NO.	DESCRIPTION	UOM	ORDER MULTIPLE
750-2LTC50	1/2" Straight, 2-piece Compression, Non-Metallic, Liquid-Tite Fitting	EA	25
750-2LTC9050	1/2" 90°, 2-piece Compression, Non-Metallic, Liquid-Tite Fitting	EA	25
750-2LTC75	3/4" Straight, 2-piece Compression, Non-Metallic, Liquid-Tite Fitting	EA	25
750-2LTC9075	3/4" 90°, 2-piece Compression, Non-Metallic, Liquid-Tite Fitting	EA	25

Romex Connectors – Metallic

These Metallic Romex Connectors are made of zinc die cast are cable connectors for Romex wire. U.L. Listed C.S.A. Approved.



CATALOG NO.	DESCRIPTION	UOM	ORDER MULTIPLE
750-RC841	3/8" Romex Connector for 1/2" Knockouts	EA	100
750-RC842	3/4" Romex Connector for 3/4" Knockouts	EA	50

U.L. Listed and C.S.A. Approved.

BX Set Screw Connectors

These connectors are for BX cable range of .445 to .630 in diameter. This product is UL listed and CSA approved.



CATALOG NO.	DESCRIPTION	UOM	ORDER MULTIPLE
640-845	Trade Size – 3/8"	EA	100

Non-Metallic Sheathed Cable (Romex Wire)

600V building wire. Easy to pull and strip, flame and moisture resistant. Saves time, labor and money. Color coded conductors of copper, PVC insulation and outer jacket with ground. U.L. Listed 719 Federal Specifications J C94.



CATALOG NO.	DESCRIPTION	UOM	ORDER MULTIPLE
620-6-2	6 AWG, 2 Conductors with Ground – 125' per pack	EA	1
620-8-2	8 AWG, 2 Conductors with Ground – 125' per pack	EA	1
620-10-2	10 AWG, 2 Conductors with Ground – 250' per pack	EA	1
620-12-2	12 AWG, 2 Conductors with Ground – 250' per pack	EA	1
620-14-2	14 AWG, 2 Conductors with Ground – 250' per pack	EA	1

U.L. Listed 719 Federal Specifications J-C94.

Aluminum Armored MC Cable

90°, C Rated aluminum metal clad cable system. THHN solid copper with specially compounded heat-resistant U.L. Listed insulation and jacket. Flexible interlocked aluminum armor. Extremely durable – withstands severe handling. U.L. Listed #4. Conforms to NEC article 333.



CATALOG NO.	DESCRIPTION	UOM	ORDER MULTIPLE
640-122	12-2 Aluminum Armored MC Cable – 100' per roll	EA	1
640-142	14-2 Aluminum Armored MC Cable – 100' per roll	EA	1

EMT (Thinwall) Fittings

These are used to join EMT conduit to boxes on enclosures.



CATALOG NO.	DESCRIPTION	UOM	ORDER MULTIPLE
625-800	Set Screw Connector – 1/2"	EA	50
625-801	Set Screw Connector – 3/4"	EA	25
625-304	Strap – One Hole – 1/2"	EA	100
625-305	Strap – One Hole – 3/4"	EA	100
625-810	Set Screw Coupling – 1/2"	EA	50
625-811	Set Screw Coupling – 3/4"	EA	25

Cable Staples

Cable Staples for NMB Cable (Romex) and Copper Insulated Staples for thermostat wire.



CATALOG NO.	DESCRIPTION	UOM	ORDER MULTIPLE
625-183	Romex Staples – 1/2", pack of 100	PK	1
625-IS5	Copper Insulated #5 Staples for T-Stat Wire	EA	100

CAPACITORS

Motor Run Capacitors—370VAC, Metal, Oval Can

These single capacitance oval, metal can capacitors are designed for continuous run.



CATALOG NO.	uf	UOM	ORDER MULTIPLE
37030H	3	EA	1
37040H	4	EA	1
37050H	5	EA	1
37050HB	5	EA	100*
37060H	6	EA	1
37075H	7.5	EA	1
37075HB	7.5	EA	100*
37100H	10	EA	1
37100HB	10	EA	100*
37125H	12.5	EA	1
37150H	15	EA	1
37175H	17.5	EA	1
37200H	20	EA	1
37250H	25	EA	1
37300H	30	EA	1
37350H	35	EA	1
37400H	40	EA	1
37450H	45	EA	1
37500H	50	EA	1
37600H	60	EA	1
37700H	70	EA	1
37800H	80	EA	1

*100 per pack

Motor Run Capacitors—370VAC

This single capacitance round, metal can capacitors are designed for continuous run.



CATALOG NO.	uf	UOM	ORDER MULTIPLE
37050R	5	EA	1
37075R	7.5	EA	1
37125R	12.5	EA	1
37150R	15	EA	1
37175R	17.5	EA	1
37200R	20	EA	1
37250R	25	EA	1
37300R	30	EA	1
37350R	35	EA	1
37400R	40	EA	1
37450R	45	EA	1
37500R	50	EA	1
37550R	55	EA	1
37600R	60	EA	1
37800R	80	EA	1
37300R-SWP*	30	EA	1
37350R-SWP*	35	EA	1

*Compact size, ideal for swimming pool motors.

Motor Run Capacitors—370VAC

Dual capacitance. Oval, metal can.



CATALOG NO.	uf	UOM	ORDER MULTIPLE
3GJ0515	15+5	EA	1
3GJ0520	20+5	EA	1
3GJ1520	20+15	EA	1
3GJ0525	25+5	EA	1
3GJ1025	25+10	EA	1
3GJ0330	30+3	EA	1
3GJ0530	30+5	EA	1
3GJ7530	30+7.5	EA	1
3GJ0535	35+5	EA	1
3GJ7535	35+7.5	EA	1
3GJ7545	45+7.5	EA	1
3GJ0540	40+5	EA	1
3GJ0545	45+5	EA	1
3GJ0555	55+5	EA	1
3GJ7555	55+7.5	EA	1
3GJ1060	60+10	EA	1

Motor Run Capacitors—370VAC

This dual capacitance round metal can capacitors are designed for continuous run.



CATALOG NO.	uf	UOM	ORDER MULTIPLE
3GR0515	15+5	EA	1
3GR0520	20+5	EA	1
3GR0325	25+3	EA	1
3GR0425	25+4	EA	1
3GR0525	25+5	EA	1
3GR0330	30+3	EA	1
3GR0530	30+5	EA	1
3GR7530	30+7.5	EA	1
3GR0335	35+3	EA	1
3GR0435	35+4	EA	1
3GR0535	35+5	EA	1
3GR1035	35+10	EA	1
3GR0340	40+3	EA	1
3GR0540	40+5	EA	1
3GR7540	40+7.5	EA	1
3GR0545	45+5	EA	1
3GR0550	50+5	EA	1
3GR0555	55+5	EA	1
3GR7555	55+7.5	EA	1
3GR0560	60+5	EA	1
3GR7560	60+7.5	EA	1
3GR0570	70+5	EA	1
3GR0580	80+5	EA	1
3GR7580	80+7.5	EA	1
3GR1080	80+10	EA	1

CAPACITORS cont'd

Motor Run Capacitors—440VAC

These single capacitance oval, metal can capacitors are designed for continuous run.



CATALOG NO.	uf	UOM	ORDER MULTIPLE
45020H	2	EA	1
45030H	3	EA	1
45040H	4	EA	1
45050H	5	EA	1
45060H	6	EA	1
45075H	7.5	EA	1
45100H	10	EA	1
45125H	12.5	EA	1
45150H	15	EA	1
45175H	17.5	EA	1
45200H	20	EA	1
45250H	25	EA	1
45300H	30	EA	1
45350H	35	EA	1
45400H	40	EA	1
45450H	45	EA	1
45500H	50	EA	1
45550H	55	EA	1
45600H	60	EA	1
45700H	70	EA	1
45800H	80	EA	1

Motor Run Capacitor—440VAC

Single capacitance. Round, metal can.



CATALOG NO.	uf	UOM	ORDER MULTIPLE
45050R	5	EA	1
45075R	7.5	EA	1
45100R	10	EA	1
45125R	12.5	EA	1
45150R	15	EA	1
45200R	20	EA	1
45250R	25	EA	1
45300R	30	EA	1
45350R	35	EA	1
45400R	40	EA	1
45450R	45	EA	1
45500R	50	EA	1
45550R	55	EA	1
45600R	60	EA	1
45700R	70	EA	1
45800R	80	EA	1

Motor Run Capacitor—440VAC

Dual capacitance. Oval, metal can.



CATALOG NO.	uf	UOM	ORDER MULTIPLE
4JJ0525	25+5	EA	1
4JJ0530	30+5	EA	1
4JJ0535	35+5	EA	1
4JJ0540	40+5	EA	1
4JJ0545	45+5	EA	1
4JJ0555	55+5	EA	1
4JJ7535	35+7.5	EA	1
4JJ7540	40+7.5	EA	1
4JJ7545	45+7.5	EA	1
4JJ1055	55+10	EA	1
4JJ0560	60+5	EA	1

Motor Run Capacitor—440VAC

Dual capacitance. Round, metal can.



CATALOG NO.	uf	UOM	ORDER MULTIPLE
4JR0520	20+5	EA	1
4JR0525	25+5	EA	1
4JR7525	25+7.5	EA	1
4JR0530	30+5	EA	1
4JR7530	30+7.5	EA	1
4JR0535	35+5	EA	1
4JR7535	35+7.5	EA	1
4JR0440	40+4	EA	1
4JR0540	40+5	EA	1
4JR7540	40+7.5	EA	1
4JR0545	45+5	EA	1
4JR7545	45+7.5	EA	1
4JR0550	50+5	EA	1
4JR7550	50+7.5	EA	1
4JR0555	55+5	EA	1
4JR1055	55+10	EA	1
4JR7555	55+7.5	EA	1
4JR0560	60+5	EA	1
4JR7560	60+7.5	EA	1
4JR1060	60+10	EA	1
4JR0570	70+5	EA	1
4JR7570	70+7.5	EA	1
4JR0580	80+5	EA	1
4JR7580	80+7.5	EA	1
4JR1080	80+10	EA	1

MOTOR RUN CAPACITORS (USA MADE)

Made in the U.S.A. Capacitors Round Metal Can

Line of made in the USA capacitors featuring dual voltage for both 370V and 440V applications. Designed specifically for the demands of aftermarket service parts.



CATALOG NO.	VOLTAGE	uf	UOM	ORDER MULTIPLE
4JR0525U	370V/440V	25+5	EA	1
4JR0530U	370V/440V	30+5	EA	1
4JR7530U	370V/440V	30+7.5	EA	1
4JR0535U	370V/440V	35+5	EA	1
4JR7535U	370V/440V	35+7.5	EA	1
4JR0540U	370V/440V	40+5	EA	1
4JR7540U	370V/440V	40+7.5	EA	1
4JR0545U	370V/440V	45+5	EA	1
4JR7545U	370V/440V	45+7.5	EA	1
4JR0550U	370V/440V	50+5	EA	1
4JR7550U	370V/440V	50+7.5	EA	1
4JR0555U	370V/440V	55+5	EA	1
4JR7555U	370V/440V	55+7.5	EA	1
4JR0560U	370V/440V	60+5	EA	1
4JR7560U	370V/440V	60+7.5	EA	1
4JR0580U	370V/440V	80+5	EA	1

Motor Start Capacitors – 110/125 VAC

Variable capacitance. Round, plastic can.



CATALOG NO.	uf	UOM	ORDER MULTIPLE
56-72	56-72	EA	1
88-108	88-108	EA	1
108-130	108-130	EA	1
124-156	124-156	EA	1
145-175	145-175	EA	1
161-193	161-193	EA	1
189-227	189-227	EA	1
200-240	200-240	EA	1
216-259	216-259	EA	1
233-292	233-292	EA	1
270-324	270-324	EA	1
324-388	324-388	EA	1
340-408	340-408	EA	1
378-440	378-440	EA	1
400-480	400-480	EA	1
460-552	460-552	EA	1
540-648	540-648	EA	1
590-708	590-708	EA	1
708-850	708-850	EA	1
829-995	829-995	EA	1
1000-1200	1000-1200	EA	1

Made in the U.S.A. Capacitors Oval Metal Can

Line of made in the USA capacitors featuring dual voltage for both 370V and 440V applications. Designed specifically for the demands of aftermarket service parts.



CATALOG NO.	VOLTAGE	uf	UOM	ORDER MULTIPLE
45050HU	370V/440V	5	EA	1
45075HU	370V/440V	7.5	EA	1
45100HU	370V/440V	10	EA	1
45150HU	370V/440V	15	EA	1
45200HU	370V/440V	20	EA	1
45250HU	370V/440V	25	EA	1
45300HU	370V/440V	30	EA	1
45350HU	370V/440V	35	EA	1
45400HU	370V/440V	40	EA	1
45450HU	370V/440V	45	EA	1
45125HU	370V/440V	12.5	EA	1
45500HU	370V/440V	50	EA	1
45600HU	370V/440V	60	EA	1
45700HU	370V/440V	70	EA	1
45800HU	370V/440V	80	EA	1

Motor Start Capacitors – 220/250 VAC

Variable capacitance. Round, plastic can.



CATALOG NO.	uf	UOM	ORDER MULTIPLE
43-53220	43-53	EA	1
56-72220	56-72	EA	1
72-88220	72-88	EA	1
88-108220	88-108	EA	1
108-130220	108-130	EA	1
124-156220	124-156	EA	1
145-175220	145-175	EA	1
161-193220	161-193	EA	1
189-227220	189-227	EA	1
216-259220	216-259	EA	1
233-292220	233-292	EA	1
270-324220	270-324	EA	1

Motor Start Capacitors – 330 VAC

Variable capacitance. Round, plastic can.



CATALOG NO.	uf	UOM	ORDER MULTIPLE
72-88330	72-88	EA	1
88-108330	88-108	EA	1
108-130330	108-130	EA	1
124-156330	124-156	EA	1
145-175330	145-175	EA	1
161-193330	161-193	EA	1
189-227330	189-227	EA	1
216-259330	216-259	EA	1
270-324330	270-324	EA	1

HARD START KITS

Torque Plus—Hard Start Kits

Totally solid state, our DST 5 is just right for all permanent split capacitor (PSC) compressors from 1/2 to 10 H.P. It can be used on units that operate on 120 through 288 Volts. The DST 6 offers a larger capacitor for severely hard to start compressors. The DST 6 can be used on all PSC single phase compressors from 1 1/2 to 10 H.P. A unique combination of relay and safety timer. The capacitor is automatically disconnected in 0.5 seconds if the compressor fails to start.



CATALOG NO.	DESCRIPTION	UOM	ORDER MULTIPLE
DST-5	Torque Plus – 300% Torque Multiplier	EA	1
DST-6	Torque Plus – 500% Torque Multiplier	EA	1

DiversiTech Hard Start Kits

DiversiTech hard start kits reduce contractor call backs by boosting the starting capacitor for a compressor. This prevents home brownouts and improves homeowner satisfaction with your service. DiversiTech's hard start kits feature a potential relay that disconnects the start capacitor from the circuit at exactly the moment it is no longer needed to boost the compressor. This results in a precision compressor start even under hard starting conditions. Replaces the Kickstart KS-1 and the 5-n-1 kit.



CATALOG NO.	DESCRIPTION	UOM	ORDER MULTIPLE
HSK1	Hard Start Kit for 3.5 to 5HP Compressor	EA	1
HSK5	Hard Start Kit for 1 to 3HP Compressor	EA	1

CONTACTORS

DiversiTech® Two Pole Definite Purpose Contactors

Definite purpose contactors can be used for heating, air conditioning, refrigeration, data processing, and food service equipment. Quick connect terminals provide for easy wiring. This contactor comes as a two pole on a small frame.



CATALOG NO.	FL AMPS	COIL VAC	UOM	ORDER MULTIPLE
EC25224	25	24	EA	1
EC252120	25	120	EA	1
EC252240	25	240	EA	1
EC252277	25	277	EA	1
EC30224	30	24	EA	1
EC302120	30	120	EA	1
EC302240	30	240	EA	1
EC40224	40	24	EA	1
EC402120	40	120	EA	1
EC402240	40	240	EA	1

DiversiTech® Three Pole Definite Purpose Contactors

Definite purpose contactors can be used for heating, air conditioning, refrigeration, data processing, and food service equipment. Quick connect terminals provide for easy wiring. This contactor comes as a three pole on a large frame.



CATALOG NO.	FL AMPS	COIL VAC	UOM	ORDER MULTIPLE
EC30324	30	24	EA	1
EC303120	30	120	EA	1
EC303240	30	240	EA	1
EC303277	30	277	EA	1
EC40324	40	24	EA	1
EC403120	40	120	EA	1
EC403240	40	240	EA	1
EC403277	40	277	EA	1
EC50324	50	24	EA	1
EC503120	50	120	EA	1
EC503240	50	240	EA	1
EC503277	50	277	EA	1
EC60324	60	24	EA	1
EC603120	60	120	EA	1
EC603240	60	240	EA	1
EC603277	60	277	EA	1
EC75324	75	24	EA	1
EC753120	75	120	EA	1
EC753240	75	240	EA	1
EC753277	75	277	EA	1
EC90324	90	24	EA	1
EC903120	90	120	EA	1
EC903240	90	240	EA	1
EC903277	90	277	EA	1

Eaton Definite Purpose Contactors - Three and Four Pole

These are Eaton's standard line of C25 DP contactors. They feature pressure plates with quick connects for 25A and 30A contactors, and lugs and quick connects for 40A to 90A contactors. They are UL recognized and CSA certified components. These contactors are designed for the HVAC and refrigeration applications.



CATALOG NO.	POLES	FL AMPS	COIL VAC	UOM	ORDER MULTIPLE
DPE253120	3	25	120	EA	1
DPE25324	3	25	24	EA	1
DPE253240	3	25	240	EA	1
DPE303120	3	30	120	EA	1
DPE30324	3	30	24	EA	1
DPE303240	3	30	240	EA	1
DPE303277	3	30	277	EA	1
DPE303480	3	30	480	EA	1
DPE403120	3	40	120	EA	1
DPE40324	3	40	24	EA	1
DPE403240	3	40	240	EA	1
DPE403480	3	40	480	EA	1
DPE503120	3	50	120	EA	1
DPE50324	3	50	24	EA	1
DPE503240	3	50	240	EA	1
DPE603120	3	60	120	EA	1
DPE60324	3	60	24	EA	1
DPE603240	3	60	240	EA	1
DPE753120	3	75	120	EA	1
DPE75324	3	75	24	EA	1
DPE753240	3	75	240	EA	1
DPE903120	3	90	120	EA	1
DPE90324	3	90	24	EA	1
DPE903240	3	90	240	EA	1
DPE304120	4	30	120	EA	1
DPE30424	4	30	24	EA	1
DPE304240	4	30	240	EA	1
DPE304277	4	30	277	EA	1
DPE404120	4	40	120	EA	1
DPE404240	4	40	240	EA	1
DPE404277	4	40	277	EA	1

Eaton Definite Purpose Contactors - One and Two Pole

These are single- and two-pole, Type C25 contactors feature a compact, efficient design with a low VA coil and straight-through wiring. Its housing design effectively limits dust and other contaminants from magnet structure—reduces or eliminates noise. They are UL recognized/CSA certified, ampere rated devices are well suited for use in heating/air conditioning, refrigeration, data processing and food service applications.



CATALOG NO.	POLES	FL AMPS	COIL VAC	UOM	ORDER MULTIPLE
DPE301120	1	30	120	EA	1
DPE30124	1	30	24	EA	1
DPE301240	1	30	240	EA	1
DPE401120	1	40	120	EA	1
DPE40124	1	40	24	EA	1
DPE252120	2	25	120	EA	1
DPE25224	2	25	24	EA	1
DPE252240	2	25	240	EA	1
DPE302120	2	30	120	EA	1
DPE30224	2	30	24	EA	1
DPE302240	2	30	240	EA	1
DPE302277	2	30	277	EA	1
DPE402120	2	40	120	EA	1
DPE40224	2	40	24	EA	1
DPE402240	2	40	240	EA	1
DPE402480	2	40	480	EA	1
DPE602120	2	60	120	EA	1

Eaton Contactor Accessories

These auxiliary contacts are side mounted contact kits for Eaton's definite purpose contactors with contact rating of 15A to 75A.



CATALOG NO.	DESCRIPTION	UOM	ORDER MULTIPLE
DPEAUX10	15-75A, 1NO	EA	1
DPEAUX11	15-75A, 1NO-1NC	EA	1
DPEAUX11QC	15-75A, 1NO-1NC with Quick Connect	EA	1
DPEAUX22	25-75A, 2NO-2NC	EA	1

TRANSFORMERS

**Transformers – Class 2 1585
UL Recognized**

The transformers provide the power source for heating, air conditioning, or refrigeration systems.



CATALOG NO.	VA	PRI	SEC	UOM	ORDER MULTIPLE
T1401	40	120	24	EA	1
T1404	40	120/208/240	24	EA	1

**Transformers – Class 2 1585
UL Recognized**

The transformers provide the power source for heating, air conditioning, or refrigeration systems. These are multi mounted with wire connection secondary.



CATALOG NO.	VA	PRI	SEC	UOM	ORDER MULTIPLE
T3401	40	120	24	EA	1
T3403	40	120/208/240	24	EA	1
T3501	50	120/208/240	24	EA	1
T5401	40	120	24	EA	1

**Transformers – Class 2 1585
UL Recognized**

The transformers provide the power source for heating, air conditioning, or refrigeration systems.



CATALOG NO.	VA	PRI	SEC	UOM	ORDER MULTIPLE
T2401	40	120	24	EA	1
T2403	40	208/240	24	EA	1
T2404	40	120/208/240	24	EA	1

**Transformers – Class 2 1585
UL Recognized**

Heavy duty with external fuse (T67XX) or circuit breaker (T77XX).



CATALOG NO.	VA	PRI	SEC	UOM	ORDER MULTIPLE
T6752	75	120/208/240	24	EA	1
T6753	75	120/208/240/480	24	EA	1
T7752	75	120/208/240/480	24	EA	1

RELAYS

General Purpose Relays – 9400 Series

This product features quick connect terminals with universal mounting with break away tabs.

CATALOG NO.	DESCRIPTION	AMPS RES	FLA/LRA@125V	FLA/LRA@250V	COIL VOLTAGE	UOM	ORDER MULTIPLE
D90-360	SPST-NO	18	12/60	8/48	24 VAC	EA	1
D90-370	SPDT	18	12/60	8/48	24 VAC	EA	1
D90-372	SPDT	18	12/60	8/48	120 VAC	EA	1
D90-380	SPST NO+NC	18	12/60	8/48	24 VAC	EA	1
D90-382	SPST NO+NC	18	12/60	8/48	120 VAC	EA	1
D90-384	SPST NO+NC	18	12/60	8/48	240 VAC	EA	1



**General Purpose Relays –
8400 Series**

This product features quick connect terminals with universal mounting with break away tabs.



CATALOG NO.	DESCRIPTION	AMPS RES/IND	COIL VOLTAGE	UOM	ORDER MULTIPLE
D90-290Q	SPST-NO	16/8	24 VAC	EA	1
D90-291Q	SPST-NO	16/8	120 VAC	EA	1
D90-292Q	SPST-NO	16/8	240 VAC	EA	1
D90-293Q	SPDT	8/8	24 VAC	EA	1
D90-294Q	SPDT	8/8	120 VAC	EA	1
D90-295Q	SPDT	8/8	240 VAC	EA	1

Potential Relays

The Potential Relay has SPST NC configurations and offers a variety of mounting positions.



CATALOG NO.	COIL VOLTAGE	PICK-UP MIN	PICK-UP MAX	DROP-OUT MAX	UOM	ORDER MULTIPLE
DPR064	395	242	272	140	EA	1
DPR066	395	223	252	130	EA	1

**General Purpose
Switching Relays**

The Switching Relay has quick connect terminals for termination. The base is designed for easy replacement of competitive relays.



CATALOG NO.	COIL VOLTAGE	TERMINALS 1-2-3	TERMINALS 4-5-6	UOM	ORDER MULTIPLE
D-90340	24	POWER	POWER	EA	1
D-90341	110/120	POWER	POWER	EA	1
D-90342	208/240	POWER	POWER	EA	1

FAN CENTERS

Fan Centers

The fan centers offer low voltage for one and two speed fan motors; auxiliary circuits in heating cooling, or heating/ cooling applications. This has a DPDT Relay and is UL rated. There are color coded pre stripped leads on this center. This product has a 24V coil voltage, power, and duty rated contacts. It mounts directly to a 4in. electrical box.



D-90113

CATALOG NO.	VOLTAGE	UOM	ORDER MULTIPLE
D-90113	120	EA	1
D-90118	208/240	EA	1

FUSES

Dual Element Fuses – 250V

Provides time delay for temporary over current conditions and motor running protection for heating and air conditioning equipment. Eliminates unnecessary maintenance from harmless overloads. U.L. Class RK 5, Standard for Safety 198E, Current Limiting Fuses, Interrupting Rating 200,000 Amps. rms. A.C.



7-CRNR40

CATALOG NO.	DESCRIPTION	UOM	ORDER MULTIPLE
7-CRNR15	15 Amps	EA	10
7-CRNR20	20 Amps	EA	10
7-CRNR25	25 Amps	EA	10
7-CRNR30	30 Amps	EA	10
7-CRNR35	35 Amps	EA	10
7-CRNR40	40 Amps	EA	10
7-CRNR45	45 Amps	EA	10
7-CRNR50	50 Amps	EA	10
7-CRNR60	60 Amps	EA	10
7-CRNR70	70 Amps	EA	5
7-CRNR80	80 Amps	EA	5
7-CRNR90	90 Amps	EA	5
7-CRNR100	100 Amps	EA	5

U.L. Class RK-5, Standard for Safety 198E, Current Limiting Fuses, Interrupting Rating 200,000 Amps. rms. A.C.

Time Delay Fuses – 600V

These plugs offer safe protection during momentary overload. No adapter necessary. U.L. Listed., Class RK5



626-HASR15

CATALOG NO.	DESCRIPTION	UOM	ORDER MULTIPLE
626-HASR10	10 Amp	EA	10
626-HASR15	15 Amp	EA	10
626-HASR20	20 Amp	EA	10
626-HASR25	25 Amp	EA	10
626-HASR30	30 Amp	EA	10
626-HASR40	40 Amp	EA	10
626-HASR60	60 Amp	EA	10

U.L. Listed.

One Time Fuses

Protection to lighting, heating, and other non transient circuits. U.L. Class K5, Standard for Safety 1988, One Time Fuse Interrupting Rating 10,000 Amps. rms. A.C., 250 VAC/VDC



7-10KOTN40

CATALOG NO.	DESCRIPTION	UOM	ORDER MULTIPLE
7-10KOTN30	30 Amps	EA	10
7-10KOTN35	35 Amps	EA	10
7-10KOTN40	40 Amps	EA	10
7-10KOTN45	45 Amps	EA	10
7-10KOTN50	50 Amps	EA	10
7-10KOTN60	60 Amps	EA	10
7-10KOTN70	70 Amps	EA	5
7-10KOTN80	80 Amps	EA	5
7-10KOTN90	90 Amps	EA	5
7-10KOTN100	100 Amps	EA	5

U.L. Class K5, Standard for Safety 1988, One Time Fuse Interrupting Rating 10,000 Amps. rms. A.C.

Time Delay Plug Fuses

These plugs offer safe protection during momentary overload. No adapter necessary. U.L. Listed.



626-30T

CATALOG NO.	DESCRIPTION	UOM	ORDER MULTIPLE
626-10T	Type "T" Plug Fuse – 10 Amp	EA	4
626-15T	Type "T" Plug Fuse – 15 Amp	EA	4
626-20T	Type "T" Plug Fuse – 20 Amp	EA	4
626-25T	Type "T" Plug Fuse – 25 Amp	EA	4
626-30T	Type "T" Plug Fuse – 30 Amp	EA	4

U.L. Listed.

FUSES cont'd

Plug Fuses

Expels gases caused by the blowing fuse, but doesn't allow flame to escape. Glass top for safety against shock. Positive visual indication of OK condition or blown condition. Distinguishes between overload and dead short conditions. Magnifying center of face. Shapes of face openings identify ratings. Meets Federal Specification WF 791E/Gen. Type 791/1. Base "W" fuses. U.L. Listed.



CATALOG NO.	DESCRIPTION	UOM	ORDER MULTIPLE
626-15	Plug Fuse Type TL – 15 Amp	EA	4
626-20	Plug Fuse Type TL – 20 Amp	EA	4
626-25	Plug Fuse Type TL – 25 Amp	EA	4
626-30	Plug Fuse Type TL – 30 Amp	EA	4

U.L. Listed.

In-Line Fuse Holder

For fusing all control circuits up to 30 amp. Features rigid plastic protective covering for each fuse. Used on AC and DC circuits. U.L. Listed.

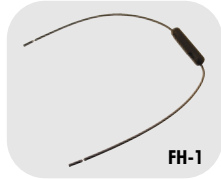

CATALOG NO.	DESCRIPTION	UOM	ORDER MULTIPLE
FH-1	In-Line Fuse Holder, Pack of 10	EA	1

U.L. Listed.

EasyID® Blade Fuses

The EasyID® series of illuminating blade fuses use Light Emitting Diode (LED) technology to indicate that a fuse has opened, making it easy to spot the opened fuse in a dark control panel. It makes it easy for a contractor to troubleshoot a problem and save time.



CATALOG NO.	DESCRIPTION	UOM	ORDER MULTIPLE
626-AT03LED	EasyID® Blade Fuse – 3 Amp – Violet, pack of 5	EA	100
626-AT05LED	EasyID® Blade Fuse – 5 Amp – Tan, pack of 5	EA	100

Fuse Pullers

Our fuse pullers are used to safely pull fuses.



CATALOG NO.	DESCRIPTION	UOM	ORDER MULTIPLE
626-38071	Fuse Puller – For Fuse Sizes 1/4" to 1/2"	EA	1
626-38073	Fuse Puller – For Fuse Sizes 1" to 1-3/4"	EA	1

Fuseblocks

The fuse blocks are designed to allow the fuse to blow or burn out before the component can be damaged.

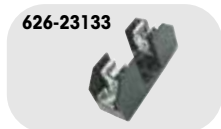

CATALOG NO.	DESCRIPTION	UOM	ORDER MULTIPLE
626-23133	Fuseblock – 1 Pole Screw Class H, 250V	EA	1
626-26311	Fuseblock – 3 Pole Box Lug Class H, 250V	EA	1

Type "S" Non-Tamper Fuses

Provides specific overcurrent protection. Time delay element protects against premature blowing from motors in air conditioners or compressors. Visual indication of good or blown condition. U.L. Listed. C.S.A. Approved.



CATALOG NO.	DESCRIPTION	UOM	ORDER MULTIPLE
626-6S	Type "S" Fuse – 6.25 Amp	EA	4
626-10S	Type "S" Fuse – 10 Amp	EA	4
626-15S	Type "S" Fuse – 15 Amp	EA	4
626-20S	Type "S" Fuse – 20 Amp	EA	4
626-30S	Type "S" Fuse – 30 Amp	EA	4

U.L. Listed. C.S.A. Approved.

Blade (Auto) Fuses

These fuses are fast acting low voltage supplementary fuses, automotive blade style fuse.



CATALOG NO.	DESCRIPTION	UOM	ORDER MULTIPLE
626-AT0003	Blade Fuse – 3 Amp – Purple, pack of 5	EA	100
626-AT0005	Blade Fuse – 5 Amp – Tan, pack of 5	EA	100

Fuse Adapters

Fuse adapters are used to retrofit fuses into existing installations.



CATALOG NO.	DESCRIPTION	UOM	ORDER MULTIPLE
626-38632	Fuse Adapter – 60 to 30 Reducer for Class H, 250V	EA	1
626-38636	Fuse Adapter – 60 to 30 Reducer for Class H, 600V	EA	1

Box Cover Units

The maximum amps on this box cover unit are 15 and the maximum AC voltage of 125. These units are designed for use with the Type T plug fuses. U.L. Listed and C.S.A. Certified.



CATALOG NO.	DESCRIPTION	UOM	ORDER MULTIPLE
620-608	Switch/Fuse Combo (ESSU)	EA	1
620-6081	Plug Fuse Base Only (ESOU)	EA	1
620-6082	Receptacle/Fuse Combo (ESRU)	EA	1
620-6083	Switch/Fuse Combo Square (ESSY)	EA	1

U.L. Listed and C.S.A. Certified.

TIME DELAYS

Adjustable Delay on Break Timer

Adjusts from 6 seconds to 8 minutes. Spin-proof knob. Works with 24, 120 or 240 VAC control circuits. Supports up to 1.0 Amps. Two wire hookup for easy installation. Solid state with quick disconnect terminals. Mounts with one self-tapping screw. Conformal coated circuitry protects against moisture and shock. UR recognized for USA and Canada. Works with anticipator type thermostats.

HOW IT WORKS: Immediately upon application of power, the Delay on Break timer enables circuit operation. Once power is interrupted, the circuit opens for the time set on the dial. After the time period elapses, the circuit closes, allowing the protected motor or compressor to start. For typical HVAC applications, the operation of the timer is transparent and will go unnoticed.



Adjustable Delay on Make Timer

Ideal for random starting of multiple units. Adjusts from 6 seconds to 8 minutes. Spin proof knob. Works with 24, 120 or 240 VAC control circuits. Supports up to 1.0 Amps. Two wire hookup for easy installation. Solid state with quick-disconnect terminals. Mounts with one self-tapping screw. Conformal coated circuitry protects against moisture and shock. UR recognized for US and Canada. Works with anticipator type thermostats.

HOW IT WORKS: These timers delay circuit closure upon application of power. Only after the set time period elapses and power remains ON will the circuit close, allowing the protected motor or compressor to start. For typical HVAC installations, timers are adjusted to random times to prevent power circuit overloads, thus are often called random start timers.



CATALOG NO.	DESCRIPTION	UOM	ORDER MULTIPLE
ADB-1	Adjustable Delay on Break	EA	1
ADB-2	Adjustable Delay on Break w/Wire Leads	EA	1

CATALOG NO.	DESCRIPTION	UOM	ORDER MULTIPLE
ADM-1	Adjustable Delay on Make	EA	1
ADM-2	Adjustable Delay on Make w/Wire Leads	EA	1

MONITORS

Digital Three Phase Line Voltage Monitor

Offers continuous protection against voltage anomalies which can damage compressors, motors and other sensitive electrically operated devices.

PROTECTION: Loss of Phase, Phase Reversal, Voltage Imbalance, Low Voltage, High Voltage

DISPLAY: Large custom LCD display indicates all operating conditions at a glance. Three large sets of digits provide easy system troubleshooting.

VOLTMETER: Three independent voltmeters read both line and contactor load (backside) voltages.

MONITORED VOLTAGE: 160 to 600 Volts 50-60 Hz.

POWER SUPPLY: Power for the WPC-500 is automatically derived from any active phase. System operation is not dependent on the control voltage or a specific phase for power.

CONTROL VOLTAGE: 19-277 VAC. Anticipator load is provided for operation with 24 volt electronic and mechanical thermostats.

OPERATING VOLTAGE SET POINT: 175 to 650 VAC. Digitally adjustable in one volt increments.

VOLTAGE TRIP POINT: Adjustable in 1% increments between 6% and 18% of selected operating voltage. Restart voltage set point (hysteresis) fixed at cutout voltage + 3%.

VOLTAGE SYMMETRY: Adjustable imbalance trip point from 2% to 25% of selected operating voltage.

RESPONSE TIMES:

Phase Loss/Reversal: 100 mS max.

Imbalance: Adjustable Response Timer

Over or Under Voltage: Adjustable Response Timer
LOCKOUT DELAY TIMER: Fully adjustable 0 to 720 Seconds (0 to 12 minutes). Digital display shows re-remaining time and user set points.

SEQUENTIAL START TIMER: 0 to 30 seconds in one second increments.

RESPONSE TIMER: 0.1 to 20 Seconds. Digital display shows remaining time and user set points.

MEMORY: Up to 25 past fault conditions are stored for later retrieval and analysis. The faults may be displayed or cleared by the front panel buttons.



Digital Single Phase Line Voltage Monitor

Automatic voltage monitor and control system. Continuously measures incoming line voltage, allowing detection of any voltage outside the tolerances that you set. If these limits are exceeded, the response timer begins counting. You may also set response time – a short time for a quick response or a long time to avoid nuisance tripping. If the voltage remains outside the tolerance after the time has elapsed, the DSP-1 will turn off its output relay and protect your device. While output is off, an additional delay timer activates to avoid rapid restarts.

FEATURES:

Digital voltmeter displays instantaneous line voltage;

Automatic voltage tester adjusts from 90 to 300 volts;

Adjustable response timer (0.1 to 10 sec.) prevents nuisance tripping;

Adjustable delay timer (1 to 720 sec.) prevents rapid restarts;

Digital display makes for easy viewing and operation

SPECIFICATIONS:

Voltmeter: 70 to 325 Volts

Voltage Set Point: 90 to 300 Volts

Tolerance Limits: 6 to 18%

Response Timer: 0.1 to 10 seconds

Delay Timer: 1 to 720 seconds

Output Relay: 10 Amps, 250 VAC resistive, single-pole/double-throw

Control Input: 18 to 250 VAC with anticipator load for 24 volt thermostats



CATALOG NO.	DESCRIPTION	UOM	ORDER MULTIPLE
DTP-3	Digital 3-Phase Motor Protector	EA	1

CATALOG NO.	DESCRIPTION	UOM	ORDER MULTIPLE
DSP-1	Digital Single Phase Motor Protector	EA	1

SURGE PROTECTORS

Surge-Trap Type 1 STXH

The most compact of the STX series offering, the Surge-Trap® Type 1 STXH meets requirements for UL1449 4th Edition and is suitable for any 120/240VAC split phase application. The STXH Series SPD features TPMOV® technology inside making it the safest product available in its category. Its compact size, performance and reliability are especially ideal for HVAC applications and direct mounting to air condition disconnect switches.



CATALOG NO.	DESCRIPTION	UPC	UOM	ORDER MULTIPLE
STXH120P05	STXH Type 1 50kA 120V Single Phase	0782001472511	EA	1
STXH240S05	STXH Type 1 50kA 240/120V Split Phase	0782001472504	EA	1

Surge-Trap Type 1 STXR

The most popular range in the STX series offering, the Surge-Trap® Type 1 STXR meets requirements for UL1449 4th Edition and is ideal for the replacement of obsolete surge arrestors. The STXR Series SPDs feature TPMOV® technology inside, making them the safest product available. With a small, compact design and line or load installation flexibility, the STXR series is the perfect fit for branch panel and/or individual equipment protection.



CATALOG NO.	DESCRIPTION	UPC	UOM	ORDER MULTIPLE
STXR208Y05N	STXR Type 1 50kA 208Y/120V N-G	0782001469962	EA	1
STXR480Y05N	STXR Type 1 50kA 480Y/277V N-G	0782001469986	EA	1
STXR240D05	STXR Type 1 50kA 240V 3-Phase DELTA	0782001469900	EA	1
STXR480D05	STXR Type 1 50kA 480V 3-Phase DELTA	0782001469917	EA	1
STXRM BK	STXR Surge Protector Mounting Bracket Kit	0782001470760	EA	1

ELECTRICAL SUPPLIES

Electrical Toggle Switches

Side wire design with automatic grounding and large binding head terminal screws for fast wiring. Lubricated cam provides smooth lever action. U.L. Listed. C.S.A. Certified. Verified to Federal Spec. WS896E



CATALOG NO.	DESCRIPTION	UOM	ORDER MULTIPLE
620-600	20A-1 HP 120V, Single Pole, Brown	EA	10
620-601	20A-1 HP 120V, Single Pole, Ivory	EA	10
625-CS120W	20A-1HP 120V Single Pole, White	EA	10
625-1301W	15A-1/2HP 120V Single Pole, White	EA	10
620-604	15A-1/2 HP 120V, Single Pole, Brown	EA	10
620-605	15A-1/2 HP 120V, Single Pole, Ivory	EA	10

U.L. Listed. C.S.A. Certified. Verified to Federal Spec. WS896E.

Electrical Duplex Receptacles

Automatic grounding for fast installation. Heavy duty mounting strap for additional assembly strength. Copper alloy power/ground contacts for optimum continuity. Side wire design with large binding head terminal screws for fast wiring. U.L. Listed. C.S.A. Certified (NEMA 5 15 Type).



CATALOG NO.	DESCRIPTION	UOM	ORDER MULTIPLE
620-700	15A, 125V, Brown	EA	10
620-701	15A, 125V, Ivory	EA	10
625-CR15W	15A 125V, White	EA	10
620-702	20A, 125V, Brown	EA	10
620-703	20A, 125V, Ivory	EA	10
625-CR20W	20A 125V, White	EA	10
620-704	15A, 125V, Brown – Residential	EA	10
620-705	15A, 125V, Ivory – Residential	EA	10
625-270W	15A 125V, White – Residential	EA	10

U.L. Listed. C.S.A. Certified (NEMA 5-15 Type).

Electrical Outlet Boxes, Extensions and Covers

We have 4in. steel square boxes, extensions, and covers available. Conforms to Article 370 of NEC. U.L. Listed.



CATALOG NO.	DESCRIPTION	UOM	ORDER MULTIPLE
620-401	2-1/8" Deep, 1/2" and 3/4" K.O.s	EA	25
620-403	1-1/2" Deep, 1/2" K.O.s	EA	50
620-404	1-1/2" Deep, 1/2" and 3/4" K.O.s Extension	EA	50
620-406	Flat Blank Cover	EA	50
620-409	Flat, One Duplex Receptacle Cover	EA	50
620-411	One Switch and One Duplex Receptacle Cover	EA	50

Conforms to Article 370 of NEC. U.L. Listed.

Plastic Wall Plates

Non flammable thermoplastic, phenolic or urea material. Color matched 1/2in. long steel mounting screws furnished. Smooth surface – no recessed areas to collect dirt, discolor. Easy to clean. Full weight and thickness provide high dielectric strength, minimum moisture absorption, impact resistance. Warp resistant, fit flush to wall. U.L. Listed. C.S.A. Approved.



CATALOG NO.	DESCRIPTION	UOM	ORDER MULTIPLE
625-2132B	Duplex Receptacle Cover – Brown	EA	25
625-2132V	Duplex Receptacle Cover – Ivory	EA	10
625-2132W	Duplex Receptacle Cover – White	EA	10
625-2134V	Single Toggle Cover – Ivory	EA	25
625-2134W	Single Toggle Cover – White	EA	25

U.L. Listed. C.S.A. Approved.

Electrical Outlet Boxes, Extensions and Covers

Standard steel utility (Handy) boxes and covers.



CATALOG NO.	DESCRIPTION	UOM	ORDER MULTIPLE
620-200	1-1/2" Deep, 1/2" K.O.s	EA	50
620-201	1-7/8" Deep, 1/2" K.O.s	EA	50
620-202	2-1/8" Deep, 1/2" K.O.s	EA	50
620-252	Flat, Two Duplex Receptacle Cover	EA	100
620-253	Flat, Toggle Switch Cover	EA	100
620-254	Flat Blank Cover	EA	100
620-255	Flat Cover 1/2" K.O.	EA	100

Conforms to Article 370 of NEC. U.L. Listed.

Switch Covers

Our switch covers come with gas, oil, or emergency already printed on them.



CATALOG NO.	SIZE	TYPE	DESCRIPTION	UOM	ORDER MULTIPLE
625-S17	4" X 4"	Gas	4" Square Box	EA	10
625-S16	4-1/4" X 2-3/4"	Gas	Utility/Handy Box	EA	1
625-S15	4-1/2" X 2-1/2"	Gas	Flush Mount	EA	25
625-S14	4" X 4"	Oil	4" Square Box	EA	1
625-S13	4-1/4" x 2-3/4"	Oil	Utility/Handy Box	EA	1
625-S19	4-1/2" X 2-1/2"	Oil	Flush Mount	EA	1
625-S20	4-3/4" X 2-1/2"	Emergency	Switch Plate	EA	1
625-S18	3/4"		Switch Guard (Wall plate/ switch not included)	EA	1

Eaton Circuit Breakers - Type CH

Type CH Circuit Breakers are 3/4-inch per pole plug-on circuit breakers designed for Eaton's Type CH Loadcenters. They are 10 kAIC arc fault circuit interrupters rated for 120VAC or 240VAC applications.



CATALOG NO.	DESCRIPTION	UOM	ORDER MULTIPLE
CH115	Single Pole, 15A	EA	10
CH120	Single Pole, 20A	EA	10
CH215	Two Pole, 15A	EA	5
CH220	Two Pole, 20A	EA	5
CH230	Two Pole, 30A	EA	5
CH240	Two Pole, 40A	EA	5
CH250	Two Pole, 50A	EA	5
CH260	Two Pole, 60A	EA	5

Switch/Plug Combo

Use with air handlers and condensate pumps. Touch-A-Matic design, with exclusive spring loaded steel ball mechanism for smooth, positive contact movement. Small neon pilot light ON when switch is ON, is built-in to the switch on switch/receptacle.



CATALOG NO.	DESCRIPTION	UOM	ORDER MULTIPLE
620-274W	White 2P 3W Grounding—15A 120V	EA	10

U.L. Listed. C.S.A. Approved.

Eaton Circuit Breakers - Type BR

Type BR Circuit Breakers are 1-inch per pole plug-on circuit breakers designed for Eaton's Type BR Loadcenters. They are 10 kAIC arc fault circuit interrupters rated for 120VAC or 240VAC applications.



CATALOG NO.	DESCRIPTION	UOM	ORDER MULTIPLE
BR115	Single Pole, 15A	EA	10
BR120	Single Pole, 20A	EA	10
BR130	Single Pole, 30A	EA	10
BR215	Two Pole, 15A	EA	5
BR220	Two Pole, 20A	EA	5
BR230	Two Pole, 30A	EA	5
BR240	Two Pole, 40A	EA	5
BR250	Two Pole, 50A	EA	5
BR260	Two Pole, 60A	EA	5
BR2100	Two Pole, 100A	EA	5

UL Certified Universal Circuit Breakers

These Type CL replacement circuit breakers are classified as direct replacements of brand specified circuit breakers by Underwriters Laboratories. These breakers are tested extensively in numerous Square D® HOME-LINE®, General Electric®, Crouse-Hinds®, Thomas & Betts®, Murray® and ITE®/Siemens® Loadcenters.



CATALOG NO.	DESCRIPTION	UOM	ORDER MULTIPLE
625-CL115	UL Circuit Breaker 1-pole, 15A, 0.5"	EA	10
625-CL120	UL Circuit Breaker 1-pole, 20A, 0.5"	EA	10
625-CL220	UL Circuit Breaker 2-pole, 20A, 1.0"	EA	5
625-CL230	UL Circuit Breaker 2-pole, 30A, 1.0"	EA	5
625-CL240	UL Circuit Breaker 2-pole 40A, 1.0"	EA	5
625-CL250	UL Circuit Breaker 2-pole, 50A, 1.0"	EA	5

ELECTRICAL SUPPLIES cont'd

Toggle Switches

These switches are available in single pole double pole. They are UL listed and furnished with screw terminals. The ratings are A:20A 125VAC, 20 250 VAC, 1 HP at 120 240 V and B 15A 125/250 VAC, ¾ HP at 240 V.



CATALOG NO.	DESCRIPTION	RATING	UOM	ORDER MULTIPLE
TS-1	Toggle Switch – SP-ST – ON/OFF	A	EA	1
TS-3	Toggle Switch – SP-DT-CO – ON/OFF/ON	B	EA	1
TS-4	Toggle Switch – DP-ST – ON/OFF	A	EA	1

Replacement Power Supply Cord

- Extends power cords for refrigerators, microwaves, air conditioners and other appliances
- Stripped at one end and angled male plug at other end
- 3-Prong flat cord
- 125VAC



CATALOG NO.	WIRE GAUGE/CONDUCTORS	AMPS	LENGTH	UOM	ORDER MULTIPLE
89223	14/3	15	6'	EA	50

Dryer Cords

- Thick vinyl insulation with right angle male plug
- 4 Wire - 10/4 Round SRDT Wire
- NEMA 14-30
- 30 Amp @ 125V/250V



CATALOG NO.	WIRE GAUGE/CONDUCTORS	LENGTH	UOM	ORDER MULTIPLE
89231	10/4	4'	EA	12
89233	10/4	6'	EA	12

Right Angle Tri-Tap Portable GFCI

- For indoor or temporary outdoor use
- Provides portable protection on tools, appliances, outdoor equipment, etc.
- Great for jobsites, workshops or marinas
- 3 outlet power cord GFCI protection against hazardous shock
- 15 Amp 120 Volt
- Automatic Reset
- Class A GFCI 4-6mA Trip
- 1875 Watt
- Grounded & Open Neutral Protection
- Insulation Volts: 1500 V RMS
- NEMA 5-15P & (3) 5-15R
- 2' 12/3 AWG SSJTW Cord
- Rainproof
- Complies with NEC 305-6
- Operating Temperature: -31°F to 151°F (-35°C to 66°C)



CATALOG NO.	DESCRIPTION	UOM	ORDER MULTIPLE
89000	Right Angle Tri-Tap Portable GFCI	EA	24

Toggle Switch Cover

Weatherproof body for toggle switches up to 15/16" long.



CATALOG NO.	DESCRIPTION	UOM	ORDER MULTIPLE
625-B1	Toggle Switch Cover	EA	5

Power Supply Cord (Pigtails)

Stranded bare copper conductors. Grounding conductors. PVC jacket. Right and straight angle male plug. 110 Volt. 16 AWG x 6' long. SPT 2.



CATALOG NO.	DESCRIPTION	UOM	ORDER MULTIPLE
625-16-6	Power Supply Cord – Straight Plug	EA	50
625-16-690	Power Supply Cord – 90 Degree Plug	EA	50

Generator Power Cord Sets

- 20 Amp & 30 Amp Cord Sets are designed for use with manual transfer switches, transfer panels and power inlet boxes
- One Piece molded Cord Plugs
- L14 Twist Lock Male/Female Receptacles
- 300 Volt SJTOW Rubber Cord
- -30°F (-34°C) Outdoor Use & Oil Resistant
- L14-20P
- L14-20R
- L14-30P
- L14-30R



CATALOG NO.	AMPS	SIZE	LENGTH	NEMA#	MAX GEN INPUT	UOM	ORDER MULTIPLE
89350	30	10/4	20'	L14-30	7.5 KW	EA	6

Range Cords

- Thick vinyl insulation with right angle male plug
- 4 Wire - 6/2 & 8/2 round SRDT Wire
- NEMA 14-60
- 50A @ 125V/250V



CATALOG NO.	WIRE GAUGE/CONDUCTORS	LENGTH	UOM	ORDER MULTIPLE
89236	6/2+8/2	4'	EA	12
89238	6/2+8/2	6'	EA	12

Heavy Duty Tri-Tap Extension Cord - 3 Outlets

- Heavy Duty 2 Foot Extension Cord with Prong Plug & Lighted Block Style Receptacles
- 15A 125V 12/3 STW Cord with Molded Plug Receptacle
- Lighted Female End to detect power
- Approved under OSHA Standards for Outdoor and Indoor Use



CATALOG NO.	LENGTH	UOM	ORDER MULTIPLE
89312	2'	EA	20

In-Line Tri-Tap Portable GFCI



- For indoor or temporary outdoor use
- Provides portable protection on tools, appliances, outdoor equipment, etc.
- Great for jobsites, workshops or marinas
- 3 outlet power cord GFCI protection against hazardous shock
- 15 Amp 120 Volt
- Automatic Reset
- Class A GFCI 4-6mA Trip
- 1875 Watt
- Grounded & Open Neutral Protection
- Insulation Volts: 1500 V RMS
- NEMA 5-15P & (3) 5-15R
- 2' 12/3 AWG SSJTW Cord
- Rainproof
- Complies with NEC 305-6
- Operating Temperature: -31°F to 151°F (-35°C to 66°C)

CATALOG NO.	DESCRIPTION	UOM	ORDER MULTIPLE
89006	In-Line Tri-Tap Portable GFCI	EA	24

Single Portable GFCI Adapter



- GFCI Protected Plug Only
- Fits any standard 3 wire outlet
- Provides instant GFCI protection
- Immediately detects ground fault from damaged cords or exposure to water and shuts off power to avoid electrocution
- 15 Amp 120 Volt
- Automatic Reset
- Class A GFCI 4-6mA Trip
- 1875 Watt
- Grounded & Open Neutral Protection
- Insulation Volts: 1500 V RMS
- NEMA 5-15P & 5-15R
- 2' 12/3 AWG SSJTW Cord
- Rainproof
- Complies with NEC 305-6
- Operating Temperature: -31°F to 151°F (-35°C to 66°C)

CATALOG NO.	DESCRIPTION	UOM	ORDER MULTIPLE
89002	Single Portable GFCI Adapter	EA	24

4-Outlet GFCI Power Pack



- Automatic Reset
- Right Angle GFCI Plug with power 'ON' LED indicator
- (4) NEMA 5-15R Outlets with separate covers for each outlet
- (1) NEMA 5-15P Plug
- 15 Amp 120 Volt
- 6' 12/3 SJTW Cord
- 15A Circuit Breaker
- Automatic Reset
- Class A GFCI 4-6mA Trip
- 1875 Watt
- Grounded & Open Neutral Protection
- Insulation Volts: 1500 V RMS
- Complies with NEC 305-6
- Operating Temperature: -31°F to 151°F (-35°C to 66°C)



CATALOG NO.	DESCRIPTION	UOM	ORDER MULTIPLE
89008	4-Outlet GFCI Power Pack	EA	24

Right Angle GFCI Plug - Field Wired



- User Attachable
- Compatible with 15 Amp U-ground outlets and plugs
- Trip Level 4-6 mA
- Automatic Reset
- Rated for indoor and outdoor use
- Class "A" people protection and GFCI
- 15 Amp 120 Volt
- 1875 Watts, 60 Hz
- LED Power 'ON' Indicator
- Open Neutral and Ground Neutral protection
- Operating Temperature: -31°F to 151°F (-35°C to 66°C)
- Impact resistant case



CATALOG NO.	DESCRIPTION	UOM	ORDER MULTIPLE
89003	Right Angle GFCI Plug - Field Wired	EA	63

5-Outlet GFCI Shock Buster



- GFCI Protected
- Plug into any 3-prong dual outlet
- Converts electrical outlet into a safety outlet
- Ideal for family TV rooms, dens, dormitory rooms, garage workshops and rec-rooms
- Protects from damaged electrical cords and hazardous electrical leakage levels
- Quick power shut off to avoid electrocution
- Built-in sensing device to detect leakage currents as low as 4mA
- 15 Amp 120 Volt



CATALOG NO.	DESCRIPTION	UOM	ORDER MULTIPLE
89009	5-Outlet GFCI Shock Buster	EA	60

ELECTRICAL TAPES

7 Mil Professional Grade Electrical Tape

- 3/4" x 66' x 7 Mil
- All Weather Professional Grade Splicing Tape used as primary insulation up to 600V and as a protective outer jacket up to 69KV
- Flame retardant and weather resistant
- Excellent cold weather resistant properties -1°F to 221°F (-18°C to 105°C)
- High dielectric strength, high adhesion and shear
- Highly elastic polymeric vinyl backing - excellent elongation
- Resistant to acids, alkalis, chemicals, oils, moisture and corrosion
- UL 510 and CSA 22.2 approved
- ASTM-D-3005 HH-I-595C
- Lead free



CATALOG NO.	COLOR	SIZE	PACKAGING TYPE	UOM	ORDER MULTIPLE
60110	Black	3/4" x 66'	Plastic Cup	EA	100

7 Mil Commercial Grade Electrical Tape

- 3/4" x 66' x 7 Mil
- Used for General Purpose Splicing as primary insulation to 600V and as a protective outer jacket at higher voltages
- Flame retardant and weather resistant
- Cold weather resistant -1°F to 221°F (-18°C to 105°C)
- Good dielectric strength, high adhesion and shear
- Resistant to acids, alkalis, chemicals, oils, moisture and corrosion
- UL 510 and CSA 22.2 approved
- MIL-I-7798A
- Lead free



CATALOG NO.	COLOR	SIZE	PACKAGING TYPE	UOM	ORDER MULTIPLE
60100	Black	3/4" x 66'	Cello	EA	100

General Purpose Vinyl Electrical Tape

- 3/4" x 60' x 7 Mil
- Used for protective jacketing & bundling/harnessing
- Resistant to acids, alkalis, chemicals, oils, moisture, sunlight and corrosion
- Flame retardant and weather resistant
- UL 510 and CSA 22.2 approved
- Lead free
- 600V



CATALOG NO.	COLOR	PACKAGE TYPE	SLEEVE QTY	UOM	ORDER MULTIPLE
60000	Black	Cello	10	EA	100
60010	Red	Cello	10	EA	100
60020	White	Cello	10	EA	100
60030	Yellow	Cello	10	EA	100
60040	Green	Cello	10	EA	100
60050	Blue	Cello	10	EA	100
60070	Orange	Cello	10	EA	100

8.5 Mil Commercial Grade Electrical Tape

- 3/4" x 66' x 8.5 Mil
- Heavier thickness for added mechanical & electrical protection
- Used for General Purpose Splicing as primary insulation to 600V and as a protective outer jacket at higher voltages
- Flame retardant and weather resistant
- Cold weather resistant -1°F to 221°F (-18°C to 105°C)
- Good dielectric strength, high adhesion and shear
- Resistant to acids, alkalis, chemicals, oils, moisture and corrosion
- UL 510 and CSA 22.2 approved
- MIL-I-7798A
- Lead free



CATALOG NO.	COLOR	SIZE	PACKAGING TYPE	UOM	ORDER MULTIPLE
60200	Black	3/4" x 66'	Cello	EA	100
60202	Black	2" x 66'	Cello	EA	40

Scotch 3M Super 33+ Electrical Tape

Premium grade, 7 mil thick, all-weather vinyl insulating tape. Performs continuously in a temperature ambient of up to 220°F and as low as 0°F. Resealable plastic case. Made in USA.



CATALOG NO.	DESCRIPTION	UOM	ORDER MULTIPLE
ET33	Super 33+ Electrical Tape – 3/4" x 66'	EA	10

Scotch 3M Super 88 Electrical Tape

Premium grade, 8.5 mil thick, all-weather vinyl insulating tape. Performs continuously in a temperature ambient of up to 220°F and as low as 0°F. Excellent resistance to abrasion, moisture, acids and corrosion. Packaged in a resealable plastic case. Made in the USA.



CATALOG NO.	DESCRIPTION	UOM	ORDER MULTIPLE
ET44	Super 88 Electrical Tape – 3/4" x 66'	EA	10

Scotch 35 Vinyl Electrical Tape

This 7 mil premium grade electrical vinyl tape stretches to conform to virtually any shape that requires color-coded insulation. Abrasion and weather resistant. Measures 3/4" x 66'.



CATALOG NO.	DESCRIPTION	UOM	ORDER MULTIPLE
ET35N	Vinyl Electrical Tape – Orange	EA	10
ET35G	Vinyl Electrical Tape – Green	EA	10
ET35R	Vinyl Electrical Tape – Red	EA	10
ET35W	Vinyl Electrical Tape – White	EA	10

ELECTRICAL TAPES cont'd

Economy Electrical Tape

This tape is suitable for use up to 175 F (80C) and not more than 600V. The electrical tape is excellent for adhesion and UL listed.



CATALOG NO.	DESCRIPTION	UOM	ORDER MULTIPLE
6-3460	3/4" x 60' Economy Electrical Tape	EA	10

Glass Cloth, Moisture Sealing, and Economy Electrical Tapes

This is a woven glass cloth tape designed to operate in 600 volt dry applications, requiring high mechanical strength and resistance to high temperatures. The glass cloth is specially treated and prepared to provide corrosion free protection. It will not shrink, rot, or burn and has a high tensile strength. It contains pressure sensitive thermosetting adhesive which performs as Class B temperature (266 degrees F / 130 degrees C). Provides hear stable insulation for hot spot applications Highlight: Color White. Width 1/2in. Length 66 ft. Thickness 7 mil. Tensile Strength (2) 150 lb./in. Material Glass Cloth.



CATALOG NO.	DESCRIPTION	UOM	ORDER MULTIPLE
GC275	1/2" x 66' Glass Cloth Electrical Tape by 3M	EA	10
GC277	3/4" x 66' Glass Cloth Electrical Tape by 3M	EA	10
ET130C1	1" x 30' Moisture Sealing Splicing Tape by 3M	EA	24
ET22	3/4" x 66' Hiawatha Electrical Tape by 3M	EA	10
AT-1700	3/4" x 66' TemFlex™ by 3M	EA	10

TERMINALS, CONNECTORS

Compressor Repair Kit

Finally, a product that simplifies the repair of burned or damaged spade terminals when reconnecting or replacing a compressor. Fits both non burned and burned terminals. Connects to the compressor via precision brass cylinders that fit over the terminals and connect with stainless steel set screws. Wires are permanently attached. Standard factory 600V, 65 strand machine wire. Easy to install and guaranteed for the life of the compressor.



CATALOG NO.	DESCRIPTION	UOM	ORDER MULTIPLE
TLC-3-8	3 Wire, 8 Gauge Connection Kit	EA	1
TLC-3-10	3 Wire, 10 Gauge Connection Kit	EA	1
TLC-3-12	3 Wire, 12 Gauge Connection Kit	EA	1

Transparent Plastic Boxes with Terminal Assortments

Boxes are made of soft, pliable, durable K resin with 18 compartments containing the most popular terminals, including hi temp and compressor terminals.



CATALOG NO.	DESCRIPTION	UOM	ORDER MULTIPLE
PA10	180 Terminals (10 Each Kind)	EA	1
PA25	360 Terminals (20 Each Kind)	EA	1
PA25AP	Appliance Parts Technician Assortment (mostly Hi-Temp)	EA	1
PA18	"K" Resin Plastic Box Only	EA	1

Replacement Compressor Leads

Extreme heat within compressors typically causes failure of wiring insulation. This can cause corrosion to the inner strands of copper within the wire used for compressor hook up. This reduces the power flow to the compressor causing the unit to overheat and can prevent the compressor from starting. A MINIMUM of 12in. of wire must be removed. The DiversiTech Replacement Compressor Leads are ideal for replacing this corroded wiring. 24in. leads also available for replacing wire all the way to the contactor and capacitor.



CATALOG NO.	DESCRIPTION	UOM	ORDER MULTIPLE
CC33	Compressor Leads – 12" with Butt, pack of 3	PK	1
CC33-18	Compressor Leads – 18" with Butt, pack of 3	PK	1
CC33-24	Compressor Leads – 24" with Ring, pack of 3	PK	1

Compartmented Storage Boxes

These boxes can be used to store your compressor terminals, nylon ties and clamps.



CATALOG NO.	DESCRIPTION	UOM	ORDER MULTIPLE
MB21	21 Compartmented Metal Box	EA	1
MB22	21 Compartmented Metal Box w/230 popular items including hi-temp and compressor terminals, nylon ties and clamps	EA	1

TERMINALS, CONNECTORS cont'd

**Grommets – Vinyl
(By Panel Hole Size)**

Grommets safely route cables and wires through sharp edged cutouts.



CATALOG NO.	DESCRIPTION	UOM	ORDER MULTIPLE
GV06*	Grommets – 3/8", pack of 18	PK	1
GV07	Grommets – 7/16", pack of 12	PK	1
GV08*	Grommets – 1/2", pack of 12	PK	1
GV10*	Grommets – 5/8", pack of 7	PK	1
GV12	Grommets – 3/4", pack of 3	PK	1
GV14*	Grommets – 7/8", pack of 4	PK	1
GVA1	Assortment – Small – GV04, GV05, GV06, GV07, GV08, pack of 15	PK	1
GVA2	Assortment – Large – GV08, GV10, GV12, GV14, GV16, pack of 5	PK	1

Sizes shown above also available in 100 packs. Replace "" with "C" for part number.

**Heat Shrink Tubing –
Polyolefin 50% Shrink, Black
Commercial Grade**

Our shrinking tube is economical and mechanically tough heat shrinkable tubing used for insulating, jacketing and identification.



CATALOG NO.	DESCRIPTION	UOM	ORDER MULTIPLE
HS03	3/16" I.D. Expanded – 4" Long, pack of 8	PK	1*
HS04	1/4" I.D. Expanded – 4" Long, pack of 7	PK	1*
HS06	3/8" I.D. Expanded – 4" Long, pack of 6	PK	1*
HS08	1/2" I.D. Expanded – 4" Long, pack of 5	PK	1*
HSA1	Assorted 3/16", 1/4", 3/8" – 4" Long, pack of 7	PK	1
HSA2	Assorted 1/2", 3/4", 1" – 4" Long, pack of 4	PK	1

Available in lengths up to 250 ft.

*These items are also available in bulk. To order, enter the catalog number followed by the letter "B". For example, HS03B is the bulk part number for HS03. Bulk items are priced and shipped by the foot.

200 Piece Terminal Kit

- High impact re-usable plastic box
- Assortment of ring & spade terminals, butt connectors, male & female disconnects

TERMINALS IN KIT

DESCRIPTION	QTY
Ring Terminal 22-16 #6	4
Ring Terminal 22-16 #8	4
Ring Terminal 22-16 #10	4
Ring Terminal 16-14 #6	4
Ring Terminal 16-14 #8	4
Ring Terminal 16-14 #10	5
Ring Terminal 12-10 #8	4
Ring Terminal 12-10 #10	6
Ring Terminal 12-10 1/4"	5
Ring Terminal 12-10 5/16"	4
Spade Terminal 22-16 #6	11
Spade Terminal 22-16 #8	13
Spade Terminal 22-16 #10	4
Spade Terminal 16-14 #6	5
Spade Terminal 16-14 #8	4
Spade Terminal 16-14 #10	4
Spade Terminal 12-10 #8	4
Spade Terminal 12-10 #10	16
Spade Terminal 12-10 1/4"	4
Butt connector 22-18	11
Butt connector 16-14	11
Butt connector 12-10	9
Vinyl Male Disconnect 22-16 .250	4
Vinyl Male Disconnect 22-14 .250	4
Vinyl Male Disconnect 22-10 .250	4
Vinyl Female Disconnect 22-18 .250	5
Vinyl Female Disconnect 16-14 .187	4
Vinyl Female Disconnect 16-14 .250	11
Vinyl Female Disconnect 12-10 .250	13
Nyl Full Ins Fem Discon 22-18	4
Nyl Full Ins Fem Discon 16-14	5
Nyl Full Ins Fem Discon 12-10 .250	4
Nyl Full Ins Male Discon 22-18 .250	4
Nyl Full Ins Male Discon 16-14 .250	4



CATALOG NO.	DESCRIPTION	UOM	ORDER MULTIPLE
10816	200 Piece Terminal Kit	EA	5

THERMAL CONTROLS

Fusible Links

Fusible Links are temperature sensitive, one time devices. Engineered as safety links, they open the circuit if the designed limit temperature is reached.

CATALOG NO.	FUSIBLE TEMP °F	TYPE	PRONG TYPE	QTY/PACK	UOM	ORDER MULTIPLE
HFL-4257	257°	In-Line		pack of 4	PK	1
HFL-4300	300°	In-Line		pack of 4	PK	1
HFL-4333	333°	In-Line		pack of 4	PK	1
HFL-5257	257°	Face Plate	Straight	pack of 2	PK	1
HFL-5258	257°	Face Plate	Right Angle	pack of 2	PK	1
HFL-5300	300°	Face Plate	Straight	pack of 2	PK	1
HFL-5301	300°	Face Plate	Right Angle	pack of 2	PK	1
HFL-5333	333°	Face Plate	Straight	pack of 2	PK	1



Replacement Element Kits

Field repair damaged element sections of electric heaters. Each kit contains a specific KW replacement element, two ceramic terminal insulator sets, plated bolts, nuts and washers.

CATALOG NO.	WATTAGE AT		IN PLACE LENGTH (INCHES)		UOM	ORDER MULTIPLE
	240V	208V	MINIMUM	MAXIMUM		
HEK-500	5000	3750	54"	162"	EA	1



Sequencers

The sequencers are used in electric heat systems to stage blower motors and heating elements. All sequencers are for 24V control.

CATALOG NO.	NO. CIRCUITS	KILXON NO.	SWITCH CONFIGURATION	DELAY ON TIME MIN.-MAX. SECONDS	DELAY OFF TIME MIN.-MAX. SECONDS	UOM	ORDER MULTIPLE
HDR-101	1 Main	60000A0211	SPST-NO	1-24	45-75	EA	1
HDR-102	1 Main	60000A0147	SPST-NO	30-75	1-40	EA	1
HDR-201	2 Main	60000E0110	DPST-NO	1-24	45-75	EA	1
HDR-202	2 Main	60000E0109	DPST-NO	30-70	1-40	EA	1
HDR-211	2 Main Staged	60200A0117	DPST-NO	30-110	1-40	EA	1
HDR-212	2 Main Staged	60200A0127	DPST-NO	1-25	50-110	EA	1
HDR-221	3 Main Staged	51172-131-1	DPST-NO SPST-NO	1-25	50-110	EA	1
HDR-222	4 Main Staged	51172-131-2	2 DPST-NO	1-40	50-110	EA	1

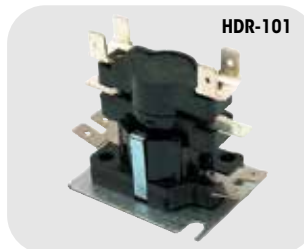

Manual Reset Fire Stat

This bi metal switch is used as a manual reset. When temperature condition is met, the device opens. The manual reset can only be reset after proper cool down of the switch. The HMR 130 is a popular fire stat in ducted air distribution systems. Should temperatures in the duct exceed 130 degree F, the switch opens, shutting down the whole system so no fire or smoke can be spread by the fan.

CATALOG NO.	DESCRIPTION	UOM	ORDER MULTIPLE
HMR-130	Bi-metal Manual Reset Fire Stat	EA	1



THERMOSTATS

LuxPro Thermostats

LuxPro thermostats are designed to be a reliable, simple solution to in home comfort, so that everyone can enjoy the benefits and comforts of advanced temperature control. Diversitech offers a variety of LuxPro models and options to match any installation need.

CATALOG NO.	DESCRIPTION	UOM	ORDER MULTIPLE
675-P521U	5-2 program, 2 H/1 C, Programmable	EA	1
675-P621U	5-1-1 program, 2 H/1 C, Programmable	EA	1
675-P721UT	7 Day, 2 H/1 C, Programmable, Touchscreen	EA	1
675-P722U	7 Day, Programmable, 2 H/2 C for Conventional, 2 H/1 C for Heat Pumps	EA	1
675-PSD010BF	Digital for Heat Only, with Fan Switch	EA	1
675-PSD111	1 H/1 C, Non-Programmable, Vertical/Horizontal	EA	1
675-PSDH121	1 or 2 H/C, Non-Programmable, Vertical/Horizontal	EA	1
675-PSM30SA	Heat Only Mechanical	EA	1
675-PSM40SA	Heating & Cool Mechanical	EA	1



THERMOSTAT GUARDS

Plastic Thermostat Guards

Use to prevent tampering with thermostats. The covers are clear, allowing complete viewing of the thermostat and current settings. Furnished complete with ring and/or solid base. Includes vent holes for easy airflow across the thermostat. Lockable with universal key. Internal dimensional clearance/sizing for thermostats as noted.

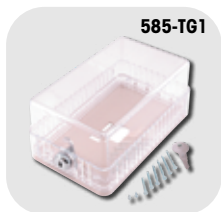

CATALOG NO.	DESCRIPTION	T-STAT CLEARANCE	UOM	ORDER MULTIPLE
585-TG	Clear Plastic w/Two Bases	8-1/4" x 4-1/2" x 3-1/4"	EA	1
585-TG1	Clear Plastic w/Two Bases	5-3/4" x 3-1/2" x 2-3/4"	EA	1
585-TG2	Clear Plastic w/Two Bases	4-3/4" x 4-1/4" x 2-3/4"	EA	1
585-TG5	Clear Plastic w/Solid Base	3-1/2" x 3-1/4" x 2-1/4"	EA	1
585-TG6	Clear Plastic w/Two Bases	6-1/4" x 3-3/4" x 1-3/4"	EA	1
585-F336	Key for Thermostat Guard		EA	1

Cross Reference

DIVERSITECH PART NO.	BEKO PART NO.	BRAMEC PART NO.	MARS PART NO.
585-TG	BTG-UK2	13012	70220
585-TG1	BTG-RK	13016	70210
585-TG2	BTG-K	13008	70205
585-TG5	BTG-EK	13004	70201
585-TG6	BTG-DK	13018	70217
585-TG8	BTG-54VLW	13001	70216

Steel Thermostat Guards

Steel thermostat guards are used to prevent tampering with thermostats. The covers are steel, giving complete tamper protection of the thermostat, and physical impact protection. Great for warehouse and industrial locations. Furnished complete with ring and/or solid base as noted. Includes vent holes for easy airflow across the thermostat. Lockable with universal key. Internal dimensional clearance/sizing for thermostats as noted.



CATALOG NO.	DESCRIPTION	T-STAT CLEARANCE	UOM	ORDER MULTIPLE
585-TG3	Beige Steel w/Solid Base	6" x 4" x 3"	EA	1
585-TG4	Beige Steel w/Ring Base	6" x 4" x 3"	EA	1
585-TG7	Beige Steel w/Solid Base	5-1/2" x 3-1/2" x 2-3/4"	EA	1
585-TG8	Beige Steel w/Ring Base	5" x 3" x 2-3/4"	EA	1
585-TG9	Beige Steel w/Two Bases	6" x 4" x 3"	EA	1

THERMOSTAT WIRE

Thermostat Wire

Class 2 thermostat wire for indoor wiring needs. Soft drawn bare copper wire, semi rigid PVC insulation and PVC overall jacket. Packaged on aluminum spool.



CATALOG NO.	DESCRIPTION	UOM	ORDER MULTIPLE
620-18-2	18 AWG, 2 Conductors – 500 ft. Spool	EA	4
620-18-3	18 AWG, 3 Conductors – 500 ft. Spool	EA	4
620-18-4	18 AWG, 4 Conductors – 250 ft. Spool	EA	4
620-18-5	18 AWG, 5 Conductors – 250 ft. Spool	EA	4
620-18-6	18 AWG, 6 Conductors – 250 ft. Spool	EA	4
620-18-7	18 AWG, 7 Conductors – 250 ft. Spool	EA	4
620-18-8	18 AWG, 8 Conductors – 250 ft. Spool	EA	4
620-18-10	18 AWG, 10 Conductors – 250 ft. Spool	EA	4
620-20-3	20 AWG, 3 Conductors – 500 ft. Spool	EA	4
620-20-4	20 AWG, 4 Conductors – 250 ft. Spool	EA	4
620-20-5	20 AWG, 5 Conductors – 250 ft. Spool	EA	4
620-20-6	20 AWG, 6 Conductors – 250 ft. Spool	EA	4
620-20-7	20 AWG, 7 Conductors – 250 ft. Spool	EA	4
620-20-8	20 AWG, 8 Conductors – 250 ft. Spool	EA	4
620-20-10	20 AWG, 10 Conductors – 250 ft. Spool	EA	4

U.L. Listed. Meets Subject 13 per Article 725, 1990 NEC.

Plenum Thermostat Wire

The Plenum Thermostat Wire is UL Listed type CL2P NEC Article 725 and is designed for use in thermostat control applications.



CATALOG NO.	DESCRIPTION	UOM	ORDER MULTIPLE
620-18-2P	18 AWG, 2 Conductors – 500 ft. Spool	EA	4
620-18-3P	18 AWG, 3 Conductors – 500 ft. Spool	EA	4
620-18-6P	18 AWG, 6 Conductors – 250 ft. Spool	EA	4
620-18-8P	18 AWG, 8 Conductors – 250 ft. Spool	EA	4

Wire for Mini-Split Installation

Wire and cabling specific for mini split installation power supply and control circuits.

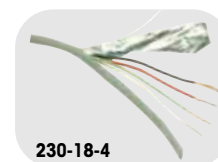

CATALOG NO.	DESCRIPTION	UOM	ORDER MULTIPLE
230-18-4	Stranded Shielded CL3R, 50' per roll	EA	1
230-14-4	Stranded Non-Shielded CL3R, 50' per roll	EA	1
230-14-7	Stranded Non-Shielded CL3R, 50' per roll	EA	1
230-14-4S	Stranded Shielded CL3R, 50' per roll	EA	1

THERMOSTAT WIRE

HVAC Mini-Split Wiring Solutions

Southwire® is a market leader with its EZ-In™ Mini-Split cable designed specifically for mini-split installations. EZ-In™ Mini-Split cable, available in both shielded and non-shielded configurations, has brought ease of installation and savings to HVAC mini-split installations by eliminating the use of conduit or cable trays. Now, Southwire® has enhanced its offering with connectors and tools specifically designed with mini-split installations in mind.



CATALOG NO.	DESCRIPTION	UOM	ORDER MULTIPLE
59351202	EZ-IN Shielded Mini-Split Cable, 14-4 Stranded, 600V, 250FT Reel	EA	1
59351203	EZ-IN Shielded Mini-Split Cable, 14-4 Stranded, 600V, 50FT Bag	EA	1
64235201	EZ-IN Shielded Mini-Split Cable Liquid Tight Straight Connector, 1/2" Hub Size	EA	25
64275801	EZ-IN Shielded Mini-Split Cable Liquid Tight 90 Degree Connector, 1/2" Hub Size	EA	15
58278040	Wire Strippers and Cutters, Heavy Duty, Stainless Steel, for 18-10AWG Wires	EA	5
58282040	Compact Conduit and Metal Scorer, Jacket Cutter	EA	3
58282240	Rotary Armor Cable Cutter with Rotary Blade	EA	2
58282340	Replacement Rotary Cutter Blades	EA	5
64846401	Point of Purchase Display with Liquid Tight Straight and 90 Degree Connectors, Cutter, Replacement Blades	EA	1



STRANDED COPPER THHN WIRE

Stranded Copper Wire in Clear Dispenser Pack, 194°F

This copper wire is UL listed and THHN wire. It is 19 strand copper and is 600 V as well as 90°C Stranded.



CATALOG NO.	DESCRIPTION	UOM	ORDER MULTIPLE
W801	08 Gauge, 10 ft., Black	EA	1
W802	08 Gauge, 10 ft., Red	EA	1
W803	08 Gauge, 10 ft., Green	EA	1
W805	08 Gauge, 10 ft., White	EA	1
W101	10 Gauge, 10 ft., Black	EA	1
W102	10 Gauge, 10 ft., Red	EA	1
W103	10 Gauge, 10 ft., Green	EA	1
W104	10 Gauge, 10 ft., Blue	EA	1
W105	10 Gauge, 10 ft., White	EA	1
W121	12 Gauge, 15 ft., Black	EA	1
W122	12 Gauge, 15 ft., Red	EA	1
W123	12 Gauge, 15 ft., Green	EA	1
W124	12 Gauge, 15 ft., Blue	EA	1
W125	12 Gauge, 15 ft., White	EA	1
W141	14 Gauge, 20 ft., Black	EA	1
W142	14 Gauge, 20 ft., Red	EA	1
W143	14 Gauge, 20 ft., Green	EA	1
W144	14 Gauge, 20 ft., Blue	EA	1
W145	14 Gauge, 20 ft., White	EA	1

Stranded Copper Wire on Spool

This copper wire is UL listed and THHN wire. It is 19 strand copper and is 600 V as well as 90°C Stranded. This comes 100 ft. per spool.



CATALOG NO.	DESCRIPTION	UOM	ORDER MULTIPLE
W801-100	08 Gauge, 100 ft. Spool, Black	EA	1
W802-100	08 Gauge, 100 ft. Spool, Red	EA	1
W803-100	08 Gauge, 100 ft. Spool, Green	EA	1
W804-100	08 Gauge, 100 ft. Spool, Blue	EA	1
W805-100	08 Gauge, 100 ft. Spool, White	EA	1
W101-100	10 Gauge, 100 ft. Spool, Black	EA	1
W102-100	10 Gauge, 100 ft. Spool, Red	EA	1
W103-100	10 Gauge, 100 ft. Spool, Green	EA	1
W104-100	10 Gauge, 100 ft. Spool, Blue	EA	1
W105-100	10 Gauge, 100 ft. Spool, White	EA	1
W121-100	12 Gauge, 100 ft. Spool, Black	EA	1
W122-100	12 Gauge, 100 ft. Spool, Red	EA	1
W123-100	12 Gauge, 100 ft. Spool, Green	EA	1
W124-100	12 Gauge, 100 ft. Spool, Blue	EA	1
W125-100	12 Gauge, 100 ft. Spool, White	EA	1
W141-100	14 Gauge, 100 ft. Spool, Black	EA	1
W142-100	14 Gauge, 100 ft. Spool, Red	EA	1
W143-100	14 Gauge, 100 ft. Spool, Green	EA	1
W144-100	14 Gauge, 100 ft. Spool, Blue	EA	1
W145-100	14 Gauge, 100 ft. Spool, White	EA	1

STRANDED COPPER THHN WIRE cont'd

Stranded Copper Wire on Spool

This copper wire is UL listed and THHN wire. It is 19 strand copper and is 600 V as well as 90°C Stranded. This comes 50 ft. per spool.

W125-50



High Temperature Wire, 400°F (204°C), 600 V.

7 strand tin coated copper wire with silicone rubber insulation protected by a braided fiberglass jacket. Use on the front of all gas furnaces with spark ignition because of flame roll out on start up. Also on all power feeds to electric strip and duct heaters. Also used on all heat producing food preparation equipment.

WHTR14-50



CATALOG NO.	DESCRIPTION	UOM	ORDER MULTIPLE
W801-50	08 Gauge, 50 ft. Spool, Black	EA	1
W802-50	08 Gauge, 50 ft. Spool, Red	EA	1
W803-50	08 Gauge, 50 ft. Spool, Green	EA	1
W804-50	08 Gauge, 50 ft. Spool, Blue	EA	1
W101-50	10 Gauge, 50 ft. Spool, Black	EA	1
W102-50	10 Gauge, 50 ft. Spool, Red	EA	1
W103-50	10 Gauge, 50 ft. Spool, Green	EA	1
W104-50	10 Gauge, 50 ft. Spool, Blue	EA	1
W105-50	10 Gauge, 50 ft. Spool, White	EA	1
W121-50	12 Gauge, 50 ft. Spool, Black	EA	1
W122-50	12 Gauge, 50 ft. Spool, Red	EA	1
W123-50	12 Gauge, 50 ft. Spool, Green	EA	1
W124-50	12 Gauge, 50 ft. Spool, Blue	EA	1
W125-50	12 Gauge, 50 ft. Spool, White	EA	1
W141-50	14 Gauge, 50 ft. Spool, Black	EA	1
W142-50	14 Gauge, 50 ft. Spool, Red	EA	1
W143-50	14 Gauge, 50 ft. Spool, Green	EA	1
W144-50	14 Gauge, 50 ft. Spool, Blue	EA	1
W145-50	14 Gauge, 50 ft. Spool, White	EA	1

CATALOG NO.	DESCRIPTION	UOM	ORDER MULTIPLE
WHT20	14 gauge, 10 ft. black, 10 ft. white	EA	1
WHTB14-50	14 gauge, black, 50 ft.	EA	1
WHTR14-50	14 gauge, red, 50 ft.	EA	1
WHTW14-50	14 gauge, white, 50 ft.	EA	1
WHTB12-50	12 gauge, black, 50 ft.	EA	1
WHTB10-50	10 gauge, black, 50 ft.	EA	1

WIRE CONNECTORS

Wire Connectors—Screw On, U.L. Listed, C.S.A Approved

Color coded connectors make quick, secure connections for positive continuity. High dielectric thermoplastic shell resists chemical action from hydrocarbons, dilute acid or alkaline solutions. Deep skirt design prevents exposure of bare wire.

623-002



CATALOG NO.	DESCRIPTION	UOM	ORDER MULTIPLE
623-001	Gray Screw-On – Size 71B, #22 to #16 AWG, 300V Max., pack of 100	PK	1
623-002	Blue Screw-On – Size 72B, #22 to #16 AWG, 300V Max., pack of 100	PK	1
623-003	Orange Screw-On – Size 73B, #22 to #14 AWG, 600V Max., pack of 100	PK	1
623-004	Yellow Screw-On – Size 74B, #18 to #10 AWG, 600V Max., pack of 100	PK	1
623-005	Red Screw-On – Size 76B, #18 to #10 AWG, 600V Max., pack of 100	PK	1

U.L. Listed. CSA Approved.

Wire Connectors—Winged, U.L. Listed, C.S.A Approved

Wings give surer grip; offset center design provides great twisting leverage. Expandable square-wire spring instantly adjusts to shape and size to create a strong, vibration-resistant connection. Same tough shell as screw-on type.

623-007



CATALOG NO.	DESCRIPTION	UOM	ORDER MULTIPLE
623-000	Lg. Gray Winged – Size 78B, #14 to #8 AWG, 600V Max., pack of 50	PK	1
623-006	Yellow Winged – Size 84, #22 to #10 AWG, 600V Max., pack of 100	PK	1
623-007	Red Winged – Size 86, #18 to #10 AWG, 600V Max., pack of 100	PK	1
623-008	Blue Winged – Size 89, #10 to #6, 600V Max., pack of 50	PK	1

U.L. Listed. C.S.A. Approved.

WIRE CONNECTORS cont'd

Twist-On Wire Connectors Combo Kit

The 623-MIX Twist-On Wire Connectors Combo Kit is a very handy and convenient wire connector kit. It contains 600 pieces of color-coded, twist-on and winged twist-on wire connectors in 9 commonly used sizes. Its durable and configurable Plano box is a great organizer for wire connector refills and storage. A wiring combinations chart for each connector is also included. It is a great truck stock item for contractors.



CATALOG NO.	DESCRIPTION	UOM	ORDER MULTIPLE
623-MIX	Twist-On Wire Connectors Combo Kit, Pack of 600	PK	1

U.L. Listed. CSA Approved.

Wire Connectors—Contractor Packs, U.L. Listed, C.S.A Approved

These connectors have a high dielectric thermoplastic shell. These are UL listed and CSA approved. This product is great for making quick and secure connections.



CATALOG NO.	DESCRIPTION	UOM	ORDER MULTIPLE
C222	Closed End Connectors 22-14 W, pack of 18	PK	1
C222C	Closed End Connectors 22-14 W, pack of 100	PK	1
C223	Closed End Connectors 18-10 W, pack of 15	PK	1
C223C	Closed End Connectors 18-10 W, pack of 100	PK	1
C241	Blue Wire Connectors 22-16 W, pack of 20	PK	1
C241L	Blue Wire Connectors 22-16 W, pack of 50	PK	1
C243	Orange Wire Connectors 22-14 W, pack of 15	PK	1
C243L	Orange Wire Connectors 22-14 W, pack of 50	PK	1
C245	Yellow Wire Connectors 18-10 W, pack of 13	PK	1
C245L	Yellow Wire Connectors 18-10 W, pack of 50	PK	1
C247	Red Wire Connectors 18-10 W, pack of 10	PK	1
C312	Yellow Winged Wire Connectors, pack of 13	PK	1
C312L	Yellow Winged Wire Connectors, pack of 50	PK	1
C512	Red Winged Wire Connectors, pack of 10	PK	1
C512L	Red Winged Wire Connectors, pack of 50	PK	1

U.L. Listed. CSA Approved.

Wire Connectors—Screw On, U.L. Listed, C.S.A Approved

Color coded connectors make quick, secure connections for positive continuity. High dielectric thermoplastic shell resists chemical action from hydrocarbons, dilute acid or alkaline solutions. Deep skirt design prevents exposure of bare wire. New handy carry handle and grip bottle. U.L. Listed. C.S.A. Approved.



CATALOG NO.	DESCRIPTION	UOM	ORDER MULTIPLE
623-012	Blue Screw-On – Size 72B, #22 to #16 AWG, 300V Max., pack of 600	PK	1
623-013	Orange Screw-On – Size 73B, #22 to #14 AWG, 600V Max., pack of 300	PK	1
623-014	Yellow Screw-On – Size 74B, #18 to #10 AWG, 600V Max., pack of 200	PK	1

U.L. Listed. CSA Approved.

Porcelain Wire Connectors

Porcelain Wire Connectors are used in high temperature applications such as appliances.



CATALOG NO.	DESCRIPTION	AWG	UOM	ORDER MULTIPLE
CPN1	Porcelain – Small, pack of 15	22-16, 2 Strand Wire	PK	1
CPN1C	Porcelain – Small, pack of 100	22-16, 2 Strand Wire	PK	1
CPN2	Porcelain – Medium, pack of 10	18-14, 2 Strand Wire	PK	1
CPN2C	Porcelain – Medium, pack of 100	18-14, 2 Strand Wire	PK	1
CPN3	Porcelain – Large, pack of 10	18-14, 3 Strand Wire	PK	1
CPN3C	Porcelain – Large, pack of 100	18-14, 3 Strand Wire	PK	1
CPN2M	Porcelain – Medium, pack of 1000	18-14, 2 Strand Wire	PK	1

WIRE/CABLE TIES, MOUNTS, CLAMPS

Cable Tie Assortment Pack

6.6 nylon, the heavy duty duct straps feature smooth insertion, and a locking mechanism that gives ductwork a firm hold. Accommodates 7 to 15 inch duct. Tensioning tool for 32"+ allows operator to adjust strap to any desired tension.



CATALOG NO.	DESCRIPTION	UOM	ORDER MULTIPLE
7-711	Natural Cable Tie Assortment – 7" and 11", pack of 150	PK	25
7-711-B	Black Cable Tie Assortment – 7" and 11", pack of 150	PK	25
7-5811	Natural Cable Tie Assortment – 5", 8", and 11", pack of 450	PK	30
7-5811-B	Black Cable Tie Assortment – 5", 8", and 11", pack of 450	PK	30

Heavy Duty Cable Ties

6.6 nylon, the heavy duty duct straps feature smooth insertion, and a locking mechanism that gives ductwork a firm hold. Accommodates 7 to 15 inch duct. Tensioning tool for 32"+ allows operator to adjust strap to any desired tension.

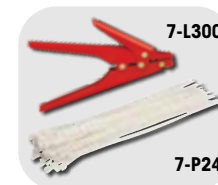

CATALOG NO.	DESCRIPTION	UOM	ORDER MULTIPLE
7-P24	24" Long – Fits up to 6" Duct – 175 lb. Tensile	EA	50
7-P36	36" Long – Fits up to 10" Duct – 175 lb. Tensile	EA	50
7-P36B	36" Long – Black – Fits up to 10" Duct – 175 lb. Tensile	EA	50
7-P48	48" Long – Fits up to 14" Duct – 175 lb. Tensile	EA	50
7-P48B	48" Long – Black – Fits up to 14" Duct – 175 lb. Tensile	EA	25
7-L300	Tensioning Tool for 120-175 lb. Ties	EA	1

WIRE/CABLE TIES, MOUNTS, CLAMPS cont'd

White Nylon Ties with Mounting Hole

These wire ties are perfect for securing wires. You can choose from an assortment of sizes.



CATALOG NO.	DESCRIPTION	TENSILE STRENGTH	UOM	ORDER MULTIPLE
WTM05	White Wire Ties with Mounting Hole – 5" Nylon, pack of 13	18	PK	1
WTM05C	White Wire Ties with Mounting Hole – 5" Nylon, pack of 100	18	PK	1
WTM07	White Wire Ties with Mounting Hole – 7" Nylon, pack of 11	50	PK	1
WTM07C	White Wire Ties with Mounting Hole – 7" Nylon, pack of 100	50	PK	1
WTM11	White Wire Ties with Mounting Hole – 11" Nylon, pack of 6	50	PK	1
WTM11C	White Wire Ties with Mounting Hole – 11" Nylon, pack of 100	50	PK	1
WTM14C	White Wire Ties with Mounting Hole – 14" Nylon, pack of 100	50	PK	1

Black Nylon Ties with Mounting Hole

These wire ties are perfect for securing wires. You can choose from an assortment of sizes.



CATALOG NO.	DESCRIPTION	TENSILE STRENGTH	UOM	ORDER MULTIPLE
WTMB05C	Black Wire Ties with Mounting Hole – 5" Nylon, pack of 100	18	PK	1
WTMB07	Black Wire Ties with Mounting Hole – 7" Nylon, pack of 10	50	PK	1
WTMB07C	Black Wire Ties with Mounting Hole – 7" Nylon, pack of 100	50	PK	1
WTMB11	Black Wire Ties with Mounting Hole – 11" Nylon, pack of 6	50	PK	1
WTMB11C	Black Wire Ties with Mounting Hole – 11" Nylon, pack of 100	50	PK	1
WTMB14C	Black Wire Ties with Mounting Hole – 14" Nylon, pack of 100	50	PK	1

Wire and Cable Clamps – Nylon

These wire ties are perfect for securing wires. You can choose from an assortment of diameter sizes.



CATALOG NO.	DESCRIPTION	UOM	ORDER MULTIPLE
WC02	Wire and Cable Clamps – 1/8" Diameter, pack of 40	PK	1
WC03	Wire and Cable Clamps – 3/16" Diameter, pack of 40	PK	1
WC04	Wire and Cable Clamps – 1/4" Diameter, pack of 35	PK	1
WC05	Wire and Cable Clamps – 5/16" Diameter, pack of 35	PK	1
WC06	Wire and Cable Clamps – 3/8" Diameter, pack of 30	PK	1
WC08	Wire and Cable Clamps – 1/2" Diameter, pack of 25	PK	1
WC09	Wire and Cable Clamps – 9/16" Diameter, pack of 20	PK	1
WC10	Wire and Cable Clamps – 5/8" Diameter, pack of 20	PK	1
WC12	Wire and Cable Clamps – 3/4" Diameter, pack of 15	PK	1
WC14	Wire and Cable Clamps – 7/8" Diameter, pack of 15	PK	1
WC16	Wire and Cable Clamps – 1" Diameter, pack of 14	PK	1
WCA1	Wire and Cable Clamps Assortment – 1/8" to 1", pack of 26	PK	1

All above sizes are available in 100 packs. Add "C" to the end of the part number.

White Nylon Wire Ties

These wire ties are perfect for securing wires. You can choose from an assortment of sizes.

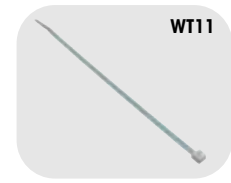

CATALOG NO.	DESCRIPTION	TENSILE STRENGTH	UOM	ORDER MULTIPLE
WT04	White Wire Ties – 4" Nylon, pack of 40	18	PK	1
WT04C	White Wire Ties – 4" Nylon, pack of 100	18	PK	1
WT05	White Wire Ties – 5" Nylon, pack of 35	18	PK	1
WT05C	White Wire Ties – 5" Nylon, pack of 100	18	PK	1
WT07	White Wire Ties – 7" Nylon, pack of 30	50	PK	1
WT07C	White Wire Ties – 7" Nylon, pack of 100	50	PK	1
WT11	White Wire Ties – 11" Nylon, pack of 15	50	PK	1
WT11C	White Wire Ties – 11" Nylon, pack of 100	50	PK	1
WT11L	White Wire Ties – 11" Nylon, pack of 50	50	PK	1
WT15	White Wire Ties – 15" Nylon, pack of 12	50	PK	1
WT15C	White Wire Ties – 15" Nylon, pack of 100	50	PK	1
WTA1	White Wire Ties – Assorted 4", 7", and 11" Nylon, pack of 30		PK	1

Black Nylon Wire Ties

These wire ties are perfect for securing wires. You can choose from an assortment of sizes. Ultraviolet resistant for outdoor use.

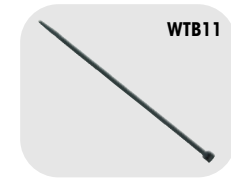

CATALOG NO.	DESCRIPTION	TENSILE STRENGTH	UOM	ORDER MULTIPLE
WTB05	Black Wire Ties – 6" Nylon, pack of 35	18	PK	1
WTB05C	Black Wire Ties – 6" Nylon, pack of 100	18	PK	1
WTB07	Black Wire Ties – 7" Nylon, pack of 30	50	PK	1
WTB07C	Black Wire Ties – 7" Nylon, pack of 100	50	PK	1
WTB07M	Black Wire Ties – 7" Nylon, pack of 1000	50	PK	1
WTB11	Black Wire Ties – 11" Nylon, pack of 15	50	PK	1
WTB11C	Black Wire Ties – 11" Nylon, pack of 100	50	PK	1
WTB11CR	Black Wire Ties, Releasable – 11" Nylon, pack of 100	50	PK	25
WTB11D	Black Wire Ties – 11" Nylon, pack of 500	50	PK	1
WTB11M	Black Wire Ties – 11" Nylon, pack of 1000	50	PK	1
WTB15	Black Wire Ties – 14" Nylon, pack of 12	50	PK	1
WTB15C	Black Wire Ties – 15" Nylon, pack of 100	50	PK	1
WTBA1	Black Wire Ties – Assorted 4", 7", and 11" Nylon, pack of 28	50	PK	1

Wire Tie Mounts

These mounts are use for mounting wires in electrical work.



CATALOG NO.	DESCRIPTION	UOM	ORDER MULTIPLE
WTM1	White Wire Tie Mounts – Adhesive Back, pack of 4	PK	1
WTM1C	White Wire Tie Mounts – Adhesive Back, pack of 100	PK	1
WTM2	White Wire Tie Mounts – #8 Screw, pack of 7	PK	1
WTM2C	White Wire Tie Mounts – #8 Screw, pack of 100	PK	1

TOOLS

Brushes..... 121-122
 Channellock® Products 122
 Electrical Supplies 123
 Fin Tools 123-124
 Gauges 125
 Manometers, Pressure And Test Kits 126
 Miscellaneous Tools 126
 Monitors..... 127
 Refractometers 127
 Rehvac Nitrogen Purging Equipment.....120
 Rehvac Refillable Gas Cylinders..... 120
 Saws and Saw Blades..... 128
 Screwdrivers, Driver Sets 128
 Snips, Notchers, Crimpers, Seamers 129
 Staples and Staple Guns..... 126
 Straps, Truck Rope..... 129-130
 Test Leads 130
 Testers 131
 Thermometers/Probes 131
 Tube Working Tools 132
 Welding Torches, Supplies 132
 Worklights by Cliplight® 124-125



REHVAC NITROGEN PURGING EQUIPMENT

Regulators

Rehvac nitrogen and CO₂ regulators feature a machined brass piston with internal bleed-down safety. This design makes the Rehvac regulator long lasting and reliable.



CT-475M

CATALOG NO.	DESCRIPTION	UOM	ORDER MULTIPLE
CA-252C	Rehvac Adjustable Regulator, 0-250psi	EA	1
CT-475M	Regulator, N/CO ₂ – 0-475 psi	EA	1

Gauges

Rehvac replacement gauges are reliable and easy to read.



GA-06

CATALOG NO.	DESCRIPTION	UOM	ORDER MULTIPLE
GA-06	Rehvac 600psi Low Pressure Replacement Gauge	EA	1
GA-30	Rehvac 3000psi High Pressure Replacement Gauge	EA	1

Hoses

Rehvac hoses are designed specifically for air, nitrogen, or CO₂ service. Featuring a 600psi working pressure and a 2200psi burst pressure, Rehvac hoses are abrasion resistant and long lasting.



CW-30

CATALOG NO.	DESCRIPTION	UOM	ORDER MULTIPLE
CW-30	Rehvac 30" Whip Hose	EA	1

Nitrogen Purge Tool

The Nitrogen Purge Tool is a quick and easy way to purge copper pipes with nitrogen. Then, with a turn of the dial, quickly switch to a very low flow of nitrogen to properly braze the copper. It has a durable aluminum design so you can just throw it into your tool bag when you are done.



DP-1

CATALOG NO.	DESCRIPTION	UOM	ORDER MULTIPLE
DP-1	Nitrogen Purge Tool	EA	1

REHVAC REFILLABLE GAS CYLINDERS

Nitrogen Cylinders

Rehvac aluminum nitrogen cylinders from DiversiTech are commonly used in the HVAC industry for line cleaning and purging, pressure testing and braze purging. Made in the USA.



N20-SD

CATALOG NO.	DESCRIPTION	UOM	ORDER MULTIPLE
N20-SD	Rehvac Nitrogen Cylinder 57 cu ft	EA	1

CO₂ Cylinders

Rehvac aluminum CO₂ cylinders from DiversiTech are commonly used in the HVAC industry for condensate line cleaning. Made in the USA.



C10

CATALOG NO.	DESCRIPTION	UOM	ORDER MULTIPLE
C10	Rehvac 10# Aluminum Cylinder	EA	1
C1-2-6	Rehvac 1.2# Cylinder	EA	1
C20	Rehvac 20# Aluminum Cylinder	EA	1
C2-5	Rehvac Cylinder, 2.5#	EA	1
C5	Rehvac 5# Aluminum Cylinder	EA	1

BRUSHES

Chip Brushes

100% pure bristle, wood handle. Poly sleeve over bristles. Inexpensive (use once and throw away). Excellent for applying duct adhesive.



CATALOG NO.	DESCRIPTION	UOM	ORDER MULTIPLE
B-501	Chip Brush – 1”	EA	36
B-502	Chip Brush – 1-1/2”	EA	36
B-503	Chip Brush – 2”	EA	24
B-504	Chip Brush – 2-1/2”	EA	12
B-505	Chip Brush – 3”	EA	12

Welder’s Brush

Stainless steel bristles used for cleaning all metals. Great for cleaning aluminum prior to soldering.

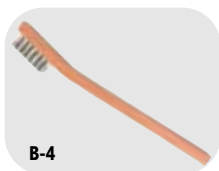

CATALOG NO.	DESCRIPTION	UOM	ORDER MULTIPLE
B-4	Welder’s Brush	EA	12

Parts Cleaning Brush

The heavy duty black polypropylene bristles are secured in a strong plastic handle.



CATALOG NO.	DESCRIPTION	UOM	ORDER MULTIPLE
542-25015	Parts Cleaning Brush	EA	12

2-in-1 Copper Tube Cleaning Brush

Easy to hold combination tool that really works. One end cleans the fitting. The other cleans the tube.



CATALOG NO.	DESCRIPTION	UOM	ORDER MULTIPLE
B-998	2-in-1 Copper Tube Cleaning Brush – 3/4” ID (7/8” OD)	EA	1

Tin Handle Acid Brushes

Manufactured with electrolyte tin plate and filled with 100% pure stiff horsehair, tied with a steel staple. This combination gives lasting qualities when used with heat and acids or other cleaning agents.



CATALOG NO.	DESCRIPTION	UOM	ORDER MULTIPLE
B-1	Tin Handle Acid Brush 3/8”	EA	144
B-2	Tin Handle Acid Brush 1/2”	EA	144

Refrigerator Coil Brush

Clean refrigerator coils, fan blades and areas under and behind appliances. 27-1/2” in length with 11-3/4” brush length. Bristles are 3/4” on the end tapering to 1-1/2” toward the handle.



CATALOG NO.	DESCRIPTION	UOM	ORDER MULTIPLE
B-27	Refrigerator Coil Brush	EA	1

Duct Cleaning Brush

These brushes are made of black fiber bristles twisted in wire. They are 1 1/8in. diameter by 7in. brush x 48in. overall length. These are idea for cleaning hard to reach areas in duct work.



CATALOG NO.	DESCRIPTION	UOM	ORDER MULTIPLE
542-76220	Duct Cleaning Brush	EA	1

BRUSHES cont'd

Copper Tube Fitting Brushes

Highest quality brushes to clean fittings faster, easier and more safely. Made with strong, resilient, rustproof stainless steel bristles secured in a 4-ply wire with easy-to-grip plastic handle. Economy models feature same quality stainless steel, but secured in 2-ply wire.



CATALOG NO.	DESCRIPTION	UOM	ORDER MULTIPLE
B-124	Copper Tube Fitting Brush – Economy 1/4" O.D., 9/32" Brush Dia.	EA	6
B-125	Copper Tube Fitting Brush – Economy 3/8" O.D., 13/32" Brush Dia.	EA	6
B-126	Copper Tube Fitting Brush – Economy 1/2" O.D., 17/32" Brush Dia.	EA	6
B-127	Copper Tube Fitting Brush – Economy 5/8" O.D., 11/16" Brush Dia.	EA	6
B-128	Copper Tube Fitting Brush – Economy 3/4" O.D., 13/16" Brush Dia.	EA	6
B-129	Copper Tube Fitting Brush – Economy 7/8" O.D., 15/16" Brush Dia.	EA	6
B-131	Copper Tube Fitting Brush – Economy 1-1/8" O.D., 1-1/4" Brush Dia.	EA	6
B-132	Copper Tube Fitting Brush – Economy 1-3/8" O.D., 1-1/2" Brush Dia.	EA	6
B-924	Copper Tube Fitting Brush – 1/4" O.D., 9/32" Brush Dia.	EA	1
B-925	Copper Tube Fitting Brush – 3/8" O.D., 13/32" Brush Dia.	EA	1
B-926	Copper Tube Fitting Brush – 1/2" O.D., 17/32" Brush Dia.	EA	1
B-927	Copper Tube Fitting Brush – 5/8" O.D., 11/16" Brush Dia.	EA	1
B-928	Copper Tube Fitting Brush – 3/4" O.D., 13/16" Brush Dia.	EA	1
B-929	Copper Tube Fitting Brush – 7/8" O.D., 15/16" Brush Dia.	EA	1
B-930	Copper Tube Fitting Brush – 1" O.D., 1-1/8" Brush Dia.	EA	1
B-931	Copper Tube Fitting Brush – 1-1/8" O.D., 1-1/4" Brush Dia.	EA	1
B-932	Copper Tube Fitting Brush – 1-3/8" O.D., 1-1/2" Brush Dia.	EA	1
B-934	Copper Tube Fitting Brush – 1-5/8" O.D., 1-3/4" Brush Dia.	EA	1
B-935	Copper Tube Fitting Brush – 2-1/8" O.D., 2-1/4" Brush Dia.	EA	1

Carbon Steel Curved Handle Scratch Brush

Carbon Steel Curved Handle Scratch Brushes are used for general purpose cleaning.



CATALOG NO.	DESCRIPTION	UOM	ORDER MULTIPLE
B-10	Carbon Steel Curved Handle Scratch Brush	EA	1

Fin Whisk

A plastic handled whisk for cleaning condenser and evaporator fins.



CATALOG NO.	DESCRIPTION	UOM	ORDER MULTIPLE
B-26	Fin Whisk Brush	EA	12

Condenser/Heat Exchanger Brushes

Ideal for cleaning mineral deposits from inside metal tubes. Especially recommended for use with power tools, although handle for manual use is available.



CATALOG NO.	DESCRIPTION	UOM	ORDER MULTIPLE
B-622	Condenser/Heat Exchanger Brush – 3/4" Brass 12-24 Female	EA	1

CHANNELLOCK® PRODUCTS

Tongue and Groove Pliers

These patented design pliers have permalock fasteners and reinforcing edge. The grips are also dipped in plastic for a more comfortable hold.



CATALOG NO.	DESCRIPTION	UOM	ORDER MULTIPLE
545-420	9-1/2" Tongue and Groove Pliers	EA	1
545-422	9-1/2" Curved Jaw Tongue and Groove Pliers	EA	1
545-426	6-1/2" Tongue and Groove Pliers	EA	1

CATALOG NO.	DESCRIPTION	UOM	ORDER MULTIPLE
545-430	10" Tongue and Groove Pliers	EA	1
545-440	12" Tongue and Groove Pliers	EA	1
545-442	12" Curved Jaw Tongue and Groove Pliers	EA	1
545-460	16" Tongue and Groove Pliers	EA	1

ELECTRICAL SUPPLIES

Outdoor Extension Cord

Heavy duty, round, vinyl extension cord designed for industrial use. Orange vinyl jacket protects against oil, grease, ozone, and gives added flexibility at below freezing temperatures. Vinyl plugs and connectors are molded on and won't break or pull off cord.

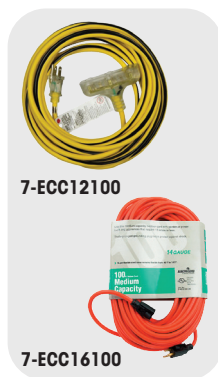

CATALOG NO.	DESCRIPTION	UOM	ORDER MULTIPLE
7-ECC12100	100' Extension Cord, 12/3 SJTW-A, 15 AMP	EA	3
7-ECC1225	25' Extension Cord, 12/3 SJTW-A, 15 AMP	EA	10
7-ECC1250	50' Extension Cord, 12/3 SJTW-A, 15 AMP	EA	6
7-ECC16100	100' 13 Amp Extension Cord SJTW-A 16/3	EA	6
7-ECC1625	25' 15 Amp Extension Cord SJTW-A 16/3	EA	24
7-ECC1650	50' 15 Amp Extension Cord SJTW-A 16/3	EA	12
7-ECC50725	25' 15 AMP Extension Cord SJTW-A 14/3	EA	14
7-ECC50730	50' 15 AMP Extension Cord SJTW-A 14/3	EA	10
7-ECC50735	100' 13 AMP Extension Cord SJTW-A 14/3	EA	5

Type: SJTW-A U.L. Listed, meets OSHA Requirements.

Power Blocks

Professional design gives contractors and industrial personnel maximum flexibility in arranging portable power needs at the job site. Vinyl connectors are solid molded for high resistance to breakage and abuse.



CATALOG NO.	DESCRIPTION	UOM	ORDER MULTIPLE
7-ADO10000	Triple tap power block adapter converts single 15 AMP 125V U-ground outlet to 3 15A, 125V U-ground outlets	EA	10

Metal Guard Trouble Lights

Designed for rugged use by contractors and industrial. Tough plastic handles are heat and shock resistant, with switch and 15A, 125V grounding side outlet.



CATALOG NO.	DESCRIPTION	UOM	ORDER MULTIPLE
7-TLC10625	25' Metal Guard Trouble Light	EA	1
7-TLC10630	50' Metal Guard Trouble Light	EA	1

AWG: 16/3 TYPE: SJTW-A U.L. Listed, meets OSHA Requirements.

Cable Clamp PRO

The Cable Clamp PRO is the ultimate reusable cable management tool. Featuring a unique push button release and integrally attached carry handle serrated for easy grip. Carry handle also includes built-in lanyard hole allowing for attachment of rope, wire, or hook. Lanyard hole may be used for tethering of Cable Clamp PRO to cords, cable, and other devices. The medium size is for bundles up to 2-inch and the large size is for bundles up to 3-inch.



CATALOG NO.	DESCRIPTION	UOM	ORDER MULTIPLE
CCP-M	Cable Clamp PRO Display Box with 34 Medium	EA	34
CCP-L	Cable Clamp PRO Display Box with 24 Large	EA	25

FIN TOOLS

Multi-Head Fin-Tool

Conveniently straightens and cleans condenser and evaporator fins. Each nylon head slides into the master handle and tightens in place. Heads are designed to fit units with fin spacing of 4–23 fins per inch. Each head is engraved with its own size and is color coded for fast identification. Heads are angled so that when inserted in the handle, the hand is a safe distance from the sharp fins. Heads may also be reversed in the handle so that combing with an upward stroke (recommended method) may be done easily with proper leverage. The master handle rests comfortably in a man size grip, is rigid and long lasting.

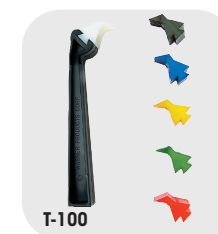

CATALOG NO.	DESCRIPTION	UOM	ORDER MULTIPLE
T-1	Handle Only – Black	EA	1
T-8	Head 8 FPI – Orange, pack of 3	PK	1
T-9	Head 9 FPI – Yellow, pack of 3	PK	1
T-10	Head 10 FPI – Natural, pack of 3	PK	1
T-11	Head 11 FPI – Blue, pack of 3	PK	1
T-12	Head 12 FPI – Green, pack of 3	PK	1
T-13	Head 13 FPI – Pink, pack of 3	PK	1
T-14	Head 14 FPI – Lt. Green, pack of 3	PK	1
T-16	Head 16 FPI – Brown, pack of 3	PK	1
T-20	Head 20 FPI – Purple, pack of 3	PK	1
T-21	Head 23 FPI – Rose (for Carrier unit), pack of 3	PK	1

U.S. Patent No. 4,018,076.

FIN TOOLS cont'd

SuperComb

Easier to grip, easier to use tool for straightening condenser and evaporator fins. Straightens 50% more fins in one stroke. Keeps hands a safe distance from fins. Easy to grip, strong, durable, heavy duty nylon. Color coded for easy identification. Sold individually or 6 per set. Sales display available.



CATALOG NO.	DESCRIPTION	UOM	ORDER MULTIPLE
T-400	Set of 6 – 1 Ea.: T-408, T-409, T-411, T-410, T-417, T-418	EA	1
T-409	9 and 15 FPI – Yellow	EA	1
T-411	11 and 13 FPI – Blue	EA	1

WORKLIGHTS BY CLIPLIGHT®

Clipstrip™ / Clipstrip 2™

Clipstrip™ is a powerful pocket light with 140 lumens and includes a pivoting magnetic clip. It is available in yellow or camo with three AAA batteries included.



CATALOG NO.	DESCRIPTION	UOM	ORDER MULTIPLE
111112	Clipstrip™ Pocket Light	EA	12
111116	Clipstrip™ Pocket Camo Light	EA	12
111118	Clipstrip 2™ Pocket Light	EA	9

PIVOT™

The PIVOT™ is a light that has a 360° swivel hook with 240 lumens and magnetic base and back. Three AA batteries included.



CATALOG NO.	DESCRIPTION	UOM	ORDER MULTIPLE
111114	PIVOT™ Pivoting Work Light	EA	9

PIVOT™ 33

The Pivot™ 33 is a light that has a 360° swivel hook with 160 lumens and magnetic back and pivoting base. Lights on front and top with three AA batteries included. Available in yellow or camo.



CATALOG NO.	DESCRIPTION	UOM	ORDER MULTIPLE
24-458	PIVOT™ 33 Work Light	EA	9
24-460	PIVOT™ 33 Work Light, Camo	EA	9

Clipstrip™ Aqua

Clipstrip™ Aqua is a waterproof light with 180 lumens and includes a magnetic clip and floats. It is available in yellow and comes with a rechargeable 2200 mAh lithium-ion battery. Sold individually.



CATALOG NO.	DESCRIPTION	UOM	ORDER MULTIPLE
111113	Clipstrip™ Aqua Light	EA	1

PIVOT™ mini

The PIVOT™ mini is a light that has a 360° swivel hook with 120 lumens and magnetic back and base. Lights on front and top with three AAA batteries included. Available in yellow or camo.



CATALOG NO.	DESCRIPTION	UOM	ORDER MULTIPLE
111115	PIVOT™ mini Pivoting Work Light	EA	12
111117	PIVOT™ mini Pivoting Work Light, Camo	EA	12

PIVOT™ Tough-Light

The PIVOT™ Tough Light has 150 lumens with a hanging hook and magnetic base. It also has 180 degree pivoting capability with three AAA batteries included.



CATALOG NO.	DESCRIPTION	UOM	ORDER MULTIPLE
111123	PIVOT™ Tough-Light Work Light	EA	8

WORKLIGHTS BY CLIPLIGHT® cont'd

Clip-On Zoom Light

The Clip-On Zoom Light provides 150 lumens, 90° pivoting capability coupled with the ability to zoom from broad to narrow. It includes a magnetic base and includes three AAA batteries.



CATALOG NO.	DESCRIPTION	UOM	ORDER MULTIPLE
111128	Clip-On Zoom Worklight	EA	8

Cliplight Extends

The Cliplight Extends has 120 lumens at the top and 140 lumens in the front with a pivoting head. The light comes with a telescopic system and magnetic base. Four AAA batteries included.



CATALOG NO.	DESCRIPTION	UOM	ORDER MULTIPLE
111130	Cliplight Extends Worklight	EA	8

HEMImini™

The HEMImini™ has up to 1000 lumens of power (4 hours - full power) with a 4400 mAh lithium-ion rechargeable battery. It includes a 180 degree swivel hook with an optional magnetic cover.



CATALOG NO.	DESCRIPTION	UOM	ORDER MULTIPLE
114301	HEMImini™ Work Light	EA	1
410239	Magnetic Cover for HEMImini™ Work Light	EA	1

HEMIPLUS™ 2

The HEMIPLUS™ 2 has up to 1200 lumens of power (4 hours - full power) with a 4400 mAh lithium-ion rechargeable battery. It includes a metal hook and removable magnetic cover.



CATALOG NO.	DESCRIPTION	UOM	ORDER MULTIPLE
114302	HEMIPLUS™ 2 Work Light	EA	1

Spotlight

The Spotlight is a cordless work light solution with up to 1200 lumens of power (3 hours - full power) with a 4000 mAh lithium-ion rechargeable battery. It includes two adjustable joints on magnetic stand for different angles. It has three power modes including a dimmer.



CATALOG NO.	DESCRIPTION	UOM	ORDER MULTIPLE
111121	Spotlight Cordless Work Light	EA	1

Curve Light

The Curve Light provides 300 lumens of lighting using chip-on board technology. Designed with a curved shape to protect the lens and rubber bumper for durability. It is rugged yet sleek. A hanging hook, magnetic base and three AA batteries are included.

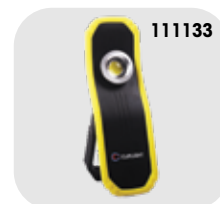

CATALOG NO.	DESCRIPTION	UOM	ORDER MULTIPLE
111133	Curve Heavy Duty Work Light	EA	6

Flex Light

The Flex Light provides 120 lumens of lighting for tight spaces with the ability to bend 90 degrees backwards and forwards. Designed with flexibility in mind, this light comes with a magnetic base and three AAA batteries.



CATALOG NO.	DESCRIPTION	UOM	ORDER MULTIPLE
111131	Flex Pocket Work Light	EA	8

GAUGES

Manifold Gauge

DiversiTech's MG-1 Manifold Gauge provides the technician with a precision diagnostic and monitoring analog gauge set complete with hoses.

The Manifold Gauge and Hose Set includes:

- 2 valve brass manifold
- 5' long high pressure hose set
- For use with the following refrigerants:
 - R-410A
 - R-22
 - R-407C
- Detailed gauge readings in PSI°F

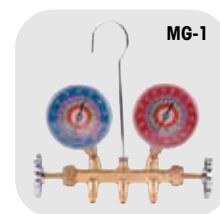

CATALOG NO.	DESCRIPTION	UOM	ORDER MULTIPLE
MG-1	Manifold Gauge and Hose Set	EA	1
MG-RGB	Replacement Gauge – blue	EA	1
MG-RGR	Replacement Gauge – red	EA	1

MANOMETERS, PRESSURE AND TEST KITS

Hydrogauge Manometer

Economical Pressure measurements.

- Replaces ordinary U-tube manometers
 - Measures gas pressure easily and efficiently
 - Direct reading, no plus or minus readings to add together as in old fashioned U-tubes
 - Fills like a glass of water, no more air bubbles
 - Strong magnet for mounting
 - Heavy-duty construction
 - Made of industrial grade, flexible PVC plastic
 - Lightweight; Easy to use
 - 6-HG15 water column height: 15"
 - Plastic: 30" to 36" of industrial grade flexible plastic
 - Hose fitting: All brass
- Includes: Mounting magnet.

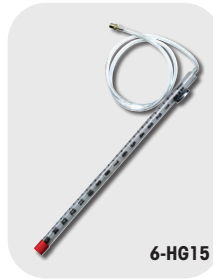

6-HG15

CATALOG NO.	DESCRIPTION	UOM	ORDER MULTIPLE
6-HG15	Hydrogauge Manometer	EA	1

Gas Pressure Test Kit

Rugged, Heavy Duty Field Use.

- Measure Natural gas (methane) or LP gas pressure across appliance manifolds.
 - Test gas stoves, furnaces, dryers and other gas appliances. Can also be used for other non-corrosive gases.
 - Large 2" sensitive diaphragm gauge is calibrated in inches of water column, also shows ounces per square inch
 - Magnified lens
 - Easier to use than a manometer
 - Range: 0 to 35 inches of water column (in. H₂O) 0 to 20 ounces per square inch (oz./in²)
- Includes: 2" sensitive diaphragm gauge; 3' of rubber tubing; brass fitting for quick connection to the appliance manifold 3/8" NPT; molded hard case.



6-GPK035

CATALOG NO.	DESCRIPTION	UOM	ORDER MULTIPLE
6-GPK035	Gas Pressure Test Kit	EA	1

STAPLES AND STAPLE GUNS

T-50 Series Staples and Staple Guns

The #1 selling staple gun in the world! Used extensively by building contractors, home do-it-yourselfers and specialty trade applications for tacking insulation, ceiling tile, window screening, cornerite, and 1001 other jobs ranging from light to heavy duty work. The T-50 Outward Clinch Staple Gun is ideal for fiberglass ductwork.



540-T50MOC



CATALOG NO.	DESCRIPTION	UOM	ORDER MULTIPLE
540-506	3/8" Leg Staples for T50 Staple Guns (1,250)	EA	4
540-508	1/2" Leg Staples for T50 Staple Guns (1,250)	EA	4
540-509	9/16" Leg Staples for T50 Staple Guns (1,250)	EA	4
540-T50M	T50M Heavy Duty Staple Gun Tacker	EA	1
540-T50MOC	T50MOC Outward Clinch Staple Gun	EA	1

MISCELLANEOUS TOOLS

Compressor TOTE

Makes light work of a heavy job. Powder coated, strong steel construction. Recommended for use with all compressors up to 5 tons. Compatible with high efficiency compressors. Pick up a compressor from its box. Carry a compressor up a ladder. Now with black protective finish.



ACT-6

CATALOG NO.	DESCRIPTION	UOM	ORDER MULTIPLE
ACT-6	Compressor Tote	EA	6

4-Piece Hook and Pick Set

For separating wires, removing small fuses, "O" rings, retrieving washers and loose parts too small to pick up with your fingers. Bright-dipped, anodized hex-shaped aluminum handles with powerful magnet on end. Handy screw-in hook, pick, point and scribe. High carbon polished needle steel. All in a compact zip-lock vinyl pouch that fits in your shirt pocket! Set includes four screw-in tips plus handle.



MHP-4

CATALOG NO.	DESCRIPTION	UOM	ORDER MULTIPLE
MHP-4	4-Piece Hook and Pick Set	EA	1

MONITORS

007 Control Checker

A lifetime tool for monitoring and checking safety controls and operating controls. One unit for all voltages 24-460 VAC or DC without switching dials or meters. Compact, 4 oz, reliable. Saves troubleshooting. For normally closed controls, 007 connects in parallel with safety control. When the safety control opens in response to a problem in the system, 007 red LED turns on and remains on until reset manually. With intermittent problem, the LED remains on indicating the control is open. For operating controls, 007 verifies the status of all types indicating if there is power to the holding coil, the NC contact is open or closed, the thermostat contacts are open or closed, there is power to the contactor or starting holding coil, the overloads are open or closed, or there is a bad connection either on control or power side. NOTE: May use with lockout relays. Features battery check and reset switch. Includes 9-volt battery. 007 may be used over and over.



CATALOG NO.	DESCRIPTION	UOM	ORDER MULTIPLE
TC-007	007 Control Checker	EA	1

U.S. Pat. No. 4,092,625.

Tattle-Tale Control Monitor

Identifies open controls in seconds. A single use monitoring device for determining which, safety control has opened in response to a malfunction. Saves wasted hours tracing a safety control shutdown, even if intermittent. A quick, inexpensive way to visually spot where the problem is. Simply install in parallel with each safety control. When a control opens, the red indicator flag pops up. You will know immediately which area of the system is experiencing problems. Disposable, safe, simple to use, and pocket sized. Monitors safety controls, fuses, overload relays, motor protectors, freeze controls, limit controls, safety switches, fusible links, or steam control. CAUTION: Not to be used with lockout relays, use TC-007.



CATALOG NO.	DESCRIPTION	UOM	ORDER MULTIPLE
TT-120	Tattle-Tale Control Monitor – 120 Volt AC or DC, pack of 3	PK	1
TT-24	Tattle-Tale Control Monitor – 24 Volt AC or DC, pack of 3	PK	1
TT-240	Tattle-Tale Control Monitor – 240 Volt AC or DC, pack of 3	PK	1

Tolerance on all voltages shown is ± 20%. U.S. Pat. No. 4,250,480.

REFRACTOMETERS

Refractometer

The Refractometer can measure the freezing point of coolants, glycol and the Charge Condition of Batteries.



CATALOG NO.	DESCRIPTION	UOM	ORDER MULTIPLE
6-REF401	Refractometer	EA	1

SAWS AND SAW BLADES

Deluxe Hi-Tension Hacksaw

Hackframe featuring handle and end pieces made of die cast aluminum. Lightweight yet rigid and highly tensioned (up to 25,000 psi) for cleaner, surer cut. Permanent blade pins feature versatile angling (up to 55°) for flush cutting. Blade can be inserted in handle to be used as compass saw. Frame will fit most standard tool boxes.



CATALOG NO.	DESCRIPTION	UOM	ORDER MULTIPLE
540-278BM0024	Replacement Blades for Hacksaw Frame 12" x 24T	EA	10
540-278HX0002	Hacksaw Frame with Blade	EA	1

Bi-Metal Reciprocating Saw Blades

Premium high speed steel with a flexible alloy back. Bi-metal blades fit all reciprocating saws with 1/2" shank.



CATALOG NO.	DESCRIPTION	UOM	ORDER MULTIPLE
540-RBCCRf	Cast Iron-Ceramic Tile Carbide Grit 8" Long	EA	1
540-RB125W	12" x 6T Wood and Nail 3/4" x 12" x .050	EA	5
540-RB414M	4" x 14T Short Metal Cutting 3/4" x 4" x .035	EA	5
540-RB418M	4" x 18T Short Metal Cutting 5/8" x 4" x .035	EA	5
540-RB610HDM	6" x 10T HD Metal Cutting 3/4" x 6" x .035	EA	5
540-RB614HDM	6" x 14T HD Metal Cutting 3/4" x 6" x .035	EA	5
540-RB618HDM	6" x 18T HD Metal Cutting 3/4" x 6" x .035	EA	5
540-RB624HDM	6" x 24T HD Metal Cutting 3/4" x 6" x .035	EA	5
540-RB636DW	Drywall Cutting with V Head 5/8" x 6" x .035	EA	5
540-RB636W	6" x 6T Wood and Nail Slope 3/4" x 6" x .050	EA	5
540-RB656WS	6" x 6T Wood and Nail Scroll 3/4" x 6" x .050	EA	5
540-RB810HDM	8" x 10T HD Metal Cutting 3/4" x 8" x .035	EA	5
540-RB814HDM	8" x 14T HD Metal Cutting 3/4" x 8" x .035	EA	5
540-RB956W	9" x 6T Wood and Nail 3/4" x 9" x .050	EA	5

SCREWDRIVERS, DRIVER SETS

Pocket 4-in-1 Mini Screwdriver

This screwdriver set is ideal for technicians, hobbyists, and do it yourselfers. There are 2 double-ended vanadium blades. You can change blades instantly and the blades are held in the carrier handled. The dimensions are 1/16 in. and 1/8 in. slotted tips and #1 and #00 cross point. The Mini Screwdriver comes in with a convenient pocket clip and capped ends.



CATALOG NO.	DESCRIPTION	UOM	ORDER MULTIPLE
6-T744	Pocket 4-in-1 Mini Screwdriver – Length: 5-1/8" (130mm)	EA	1

Combination Screwdrivers

Multiple bits in one handy screwdriver. No need for a toolbox for those quick jobs. Lifetime guarantee.



CATALOG NO.	DESCRIPTION	UOM	ORDER MULTIPLE
5-41	4-in-1 with #1 and #2 Phillips, 3/16" and 5/16" Slotted	EA	12
5-61	6-in-1 with #1 and #2 Phillips, 3/16" and 5/16" Slotted 1/4" Nut Driver, and 5/16" Nut Driver	EA	12

SNIPS, NOTCHERS, CRIMPERS, SEAMERS

Aviation Snips

Moly alloy tool steel blade is hot drop-forged and scientifically heat-treated to provide a strong, longer lasting cutting edge. Durable serrated blades are designed to grip the metal for cutting ease. The patent pending spring on these snips is guaranteed to last for the life of the tool. Will cut 18 gauge cold-rolled steel.



CATALOG NO.	DESCRIPTION	UOM	ORDER MULTIPLE
540-6716B	Aviation Snip – Bulldog Notching Snip – Blue Handle	EA	6
540-6716L	Aviation Snip – Cuts Left – Red Handle	EA	6
540-6716R	Aviation Snip – Cuts Right – Green Handle	EA	6
540-6716S	Aviation Snip – Cuts Straight – Yellow Handle	EA	6

HVAC Tools

Hot drop-forged carbon steel blades. Compound leverage action handles. Heavy duty plastic grips.



CATALOG NO.	DESCRIPTION	UOM	ORDER MULTIPLE
540-FCTMC5	8" Crimper – 22 Ga. Crimping Capacity	EA	1
540-FCTMN1	8" Notcher – 31° Cutting Angle	EA	1
540-FCTMS1	3" Straight Seamer – 22 Ga. Capacity	EA	1
540-FCTMS2	3" Offset Seamer – 22 Ga. Capacity	EA	1

Offset Snips

The same high quality construction as the Aviation Snips with an additional advantage – the Offset Snips allow your hand to stay above metal for cutting ease and comfort.



CATALOG NO.	DESCRIPTION	UOM	ORDER MULTIPLE
540-6510L	Offset Snip – Cuts Left – Red Handle	EA	6
540-6510R	Offset Snip – Cuts Right – Green Handle	EA	6

Upright Snips

This snip significantly improves sheet metal cutting. The ergonomic design allows for easier cutting in tight places, improved safety by elevating hands above metal working surfaces, and increases wrist range motion.



CATALOG NO.	DESCRIPTION	UOM	ORDER MULTIPLE
540-6900L	Upright Snips – Left-handed Model	EA	6
540-6900R	Upright Snips – Right-handed Model	EA	6

STRAPS, TRUCK ROPE

Truck Rope

All-purpose high strength polypropylene truck rope is C.H.P. approved.



CATALOG NO.	DESCRIPTION	UOM	ORDER MULTIPLE
25001	Truck Rope – 3/8" x 50'	EA	1
CR070	Truck Rope – 3/8" x 50' (Yellow)	EA	1

Lashing Strap

Quickly lashes and secures refrigerators, air conditioners, washers, driers, etc. Strong nylon webbing rated at 3000 lbs. and end hooks at 1200 lbs. tensile strength. Hand loop for easy tightening. Steel cam lever buckle is easy to adjust and releases quickly. Secures a maximum load of 1000 pounds. 12' long.



CATALOG NO.	DESCRIPTION	UOM	ORDER MULTIPLE
HS-144	Lashing Strap – 144"	EA	6

STRAPS, TRUCK ROPE cont'd

Ratchet Strap

Easy ratcheting permits tie-down of appliances securely. An innovative latch and a fast release cam reduces socket wear. Cadmium-plated steel buckle has a positive lock that eliminates release due to vibration. When closed, the handle locks the latch into the sprocket to prevent inadvertent release. 16' nylon webbing rated at 3000 PSI tensile. Vinyl coated end hooks rated at 1200 PSI tensile.



CATALOG NO.	DESCRIPTION	UOM	ORDER MULTIPLE
HS-192	Ratchet Strap – 16'	EA	3

Hanging Strap

Strong, versatile, easy way to secure loose gear safely. Tie down ladders, tubing, cylinders or almost anything in seconds. Cannot snap back. Strong, durable 1" polypropylene webbing. Reinforced grommet lets you hang it up, tie it up, hook it up or attach it permanently. Spring loaded adjustable buckle. Easy to get firm tension with no slipping. Make an endless length by connecting 2 or more together.



CATALOG NO.	DESCRIPTION	UOM	ORDER MULTIPLE
HS-30	Hanging Strap – 31"	EA	24
HS-30-2	Hanging Strap – 31", 2 Straps per Card, pack of 12	PK	1
HS-60	Hanging Strap – 60"	EA	24
HS-60-2	Hanging Strap – 60", 2 Straps per Card, pack of 12	PK	1

Rubber Tie Down Strap

Can stretch to double its length. Quickly ties down ladders, tubing, cylinders or almost anything. Extra heavy steel "S" hooks on each end. Resists cracking and deterioration.



CATALOG NO.	DESCRIPTION	UOM	ORDER MULTIPLE
RS-9	Rubber Tie Down Strap – 10"	EA	10
RS-15	Rubber Tie Down Strap – 15"	EA	10
RS-20	Rubber Tie Down Strap – 20"	EA	10
RS-31	Rubber Tie Down Strap – 31"	EA	10
RS-41	Rubber Tie Down Strap – 41"	EA	10

Carabiners

Carabiners come in a 2 piece package and are made of 8 mm anodized aluminum. Great for attaching ropes and clipping to tool belts. For indoor or outdoor use – work or leisure. Various colors.



CATALOG NO.	DESCRIPTION	UOM	ORDER MULTIPLE
540-CARABINER	Carabiner Clip, pack of 2	PK	1

TEST LEADS

Test Leads

Alligator clips are covered by pure vinyl boots for flexibility at any temperature without cracking.



CATALOG NO.	DESCRIPTION	UOM	ORDER MULTIPLE
ACK4	2 Red and 2 Black Boots w/4 Alligator Clips	EA	1
FTL3	Pair, Red and Black – 36"	EA	1
FTL3D	Pair, Red and Black – Super Heavy Duty – 36"	EA	1

Multi Color Test Leads

Easy to use multi-colored test leads. 5 colors (white, red, black, yellow, green) with 2 connections each for easy testing on the job. Wire is 18 gauge, 18" long.



CATALOG NO.	DESCRIPTION	UOM	ORDER MULTIPLE
CT800	Multi Color Test Leads	EA	1

Magjumper

Magjumper from DiversiTech is a magnetic jumper for low voltage troubleshooting. It features a 20" length with magnetic tips that won't pop off like alligator clips sometimes can. It stays flexible even in cold weather and is perfect for recessed terminals. Magjumper is ideal for use on control boards, zone panels, thermostats, hydronics and automation controllers.



CATALOG NO.	DESCRIPTION	UOM	ORDER MULTIPLE
MAG-1	Magjumper Terminal Kit	EA	1

TESTERS

Test Cord (Female)

Heavy duty red and black boots are on this cord. The cord has large clips, 3 wires, and is 24in. With this cord, you can get power in remote areas without an 110V outlet. The voltage is 3 to 20 V and has 125 AMPs. The wire gauge is 16 and the weight is .36 lb.



CATALOG NO.	DESCRIPTION	UOM	ORDER MULTIPLE
6-CT700F	Test Cord (Female)	EA	1

Leak Test Gauge

This Gas gauge test is ideal for teasing all new installations of or leaks and passing inspection code. The special sensitive diaphragm gauges for more accurate low pressure readings.



CATALOG NO.	DESCRIPTION	UOM	ORDER MULTIPLE
TG-05	Leak Test Gauge – 3/4" FPT., 15 psi	EA	1
TG-30-12	Leak Test Gauge – 1/2" FPT. Conn., 30 psi	EA	1
TG-30	Leak Test Gauge – 3/4" FPT. Conn., 30 psi	EA	1
TG-30-1	Leak Test Gauge – 1" FPT. Conn., 30 psi	EA	1

THERMOMETERS/PROBES

Digital Thermometer

Temperature range from -40°F to 230°F. Packaged on attractive display card.



CATALOG NO.	DESCRIPTION	UOM	ORDER MULTIPLE
541-300	Digital Thermometer	EA	1

Horizontal Refrigerator/Freezer Analog Thermometer

With this analog thermometer, you can use it either hanging or free standing. The easy to ready display can be seen with a horizontal reading. Both F and C scales are reflected on the thermometer and the range is -40° to 80°F (-40° to 27°C).



CATALOG NO.	DESCRIPTION	UOM	ORDER MULTIPLE
6-FT80H	Horizontal Refrigerator/Freezer Analog Thermometer	EA	1

Deluxe Digital Pocket Thermometer

Deluxe Digital Pocket Thermometers are water and drop resistant and have a rugged construction. There is an auto power off and an F/C Switch. The probe is 2.5 in. and the range is from -40 degrees F to 300 degrees F or -40 degrees C to 150 degrees C. This thermometer comes with a protective cover with clip.



CATALOG NO.	DESCRIPTION	UOM	ORDER MULTIPLE
6-HDT304K	Deluxe Digital Pocket Thermometer	EA	1

Analog Pocket Thermometer with Magnifying Lens

- Range 6-320: -40° to 160°F
 - Range 6-321: -0° to 220°F
 - Rugged stainless steel probe
- Includes: Protective sheath with pocket clip.



CATALOG NO.	DESCRIPTION	UOM	ORDER MULTIPLE
6-321	Analog Pocket Thermometer: Range -0° to 220°F	EA	1

Refrigerator/Freezer Analog Thermometer

This analog thermometer is stainless steel and can be used either hanging or free standing. The easy to read round dial is in F only. There are temperature indicators with a range -20° to 80°F (-29° to 27°C)



CATALOG NO.	DESCRIPTION	UOM	ORDER MULTIPLE
6-FT80R	Refrigerator/Freezer Analog Thermometer	EA	1

TUBE WORKING TOOLS

Kut-All Plastic Tube and Hose Cutter

Tough, durable nylon. Blade closes into its own handle for safe handling. Replaceable high carbon, teflon coated steel blades. Ideal for cutting up to 1-1/8" I.D. plastic tubing, reinforced plastic tubing, rigid plastic pipe, and rubber hose.



CATALOG NO.	DESCRIPTION	UOM	ORDER MULTIPLE
PK-2	Kut-All Plastic Tube and Hose Cutter	EA	1

Swivel Head Deburring Tool

This Swivel head Deburring Tool has the professional quality and the performance of a higher price deburring tool without the price tag. This product has two interchangeable blades.



CATALOG NO.	DESCRIPTION	UOM	ORDER MULTIPLE
6-T482	Handle length: 5-1/8" (130mm)	EA	1

One-Handed PVC/Hose Cutter

The ratchet system holds the blade in place while you adjust your grip to increase the pressure. The high carbon steel blade maintains sharpness and resists chipping. These cutters can be used for cutting PVC, CPVC, Polyethylene, PEX, and ABS tubing. The cutters have a quick-blade reset and can be used as a one handed operation. With the handle locking strap for safe storage, the easy replacing blade feature, and the ergonomically designed handle, these cutters are a perfect addition to any tool box.



CATALOG NO.	DESCRIPTION	UOM	ORDER MULTIPLE
6-T1191	Capacity: 1/8" to 1-5/8"; Length: 8-1/4" (210mm)	EA	1

WELDING TORCHES, SUPPLIES

Heat Resistant Cloth

This flame barrier drop cloth withstands temperatures to 3,000°F. No asbestos. Protects walls, floors, equipment, components and adjacent surfaces from torch flames when soldering, brazing or welding. All cloths have edges taped and sewn with grommets at each corner. Highly resistant to many chemicals and acids.

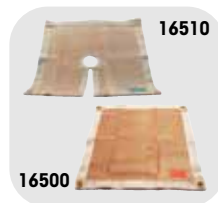

CATALOG NO.	DESCRIPTION	UOM	ORDER MULTIPLE
16500	18" x 18" Plain	EA	1
16510	18" x 18" Keyhole w/cutout for draping over pipes/tubes	EA	1
16520	36" x 36" Plain	EA	1

Map-Pro and Propane Gas

Map-Pro and Propane Gas are tanks that can be used to weld products.



CATALOG NO.	DESCRIPTION	UOM	ORDER MULTIPLE
525-MT1	Map-Pro Gas – 14 oz.	EA	12
525-PT1	Propane Gas – 14.1 oz.	EA	12

Portable Hand Torch

Self igniting hand torch eliminates the need for a flint lighter. Lightweight and portable, this flame tool can be operated with Propane or MAP-Pro™ (Propylene). Features trigger lock with instant safety release, full size comfort grip and 360° swivel tip. Operates in any position, even upside down. Includes swirl combustion tip end.



CATALOG NO.	DESCRIPTION	UOM	ORDER MULTIPLE
525-TORCH	Portable Hand Torch	EA	1

PLUMBING

CPVC-CTS Pipe and Fittings.....	134
Nylon Fittings	134-135
Oatey® Products	136
PVC Condensate Pipe	138
PVC DWV Fittings	138
PVC Primer and Cement	137
PVC Schedule 40 Pressure Fittings	139-141
Supports	142
Tubing, Clamps, and Kits	142



CPVC-CTS PIPE AND FITTINGS

CPVC-CTS Pipe by FlowGuard® Gold™

CTS = Copper Tube Size

CATALOG NO.	DESCRIPTION	UOM	ORDER MULTIPLE
4700-12	1/2" x 10' CPVC Pipe, 500'	EA	500'
4700-34	3/4" x 10' CPVC Pipe, 250'	EA	250'



4700-12

CPVC-CTS Fittings by FlowGuard® Gold™

CTS = Copper Tube Size

CATALOG NO.	DESCRIPTION	UOM	ORDER MULTIPLE
4701-12	1/2" Coupling S x S	EA	20
4704-12	1/2" Adapter M x S	EA	20
4707-12	1/2" 90° Elbow S x S	EA	20
4711-12	1/2" Tee S x S x S	EA	20
47072-12	1/2" 90° Street Ell S x S	EA	10
4718-12	3/4" x 1/2" CPVC Bushing	EA	10
4701-34	3/4" Coupling S x S	EA	20
4703-34	3/4" Adapter F x S	EA	25
4704-34	3/4" Adapter M x S	EA	10
4706-34	3/4" 45° Elbow S x S	EA	20
4707-34	3/4" 90° Elbow S x S	EA	20
4711-34	3/4" Tee S x S x S	EA	20
47072-34	3/4" 90° Street Ell S x S	EA	10



4703-34

NYLON FITTINGS*

Male Adapter (Barb x MIPT)



701-001

CATALOG NO.	DESCRIPTION	UOM	ORDER MULTIPLE
701-001	Adapter – 1/2" Barb x 1/2" MIPT, pack of 2	PK	1
701-002	Adapter – 1/2" Barb x 3/4" MIPT, pack of 2	PK	1
701-003	Adapter – 1/2" Barb x 3/8" MIPT, pack of 2	PK	1
701-007	Adapter – 3/4" Barb x 3/4" MIPT, pack of 2	PK	1
701-012	Adapter – 3/8" Barb x 1/2" MIPT, pack of 2	PK	1
701-013	Adapter – 3/8" Barb x 3/8" MIPT, pack of 2	PK	1
701-014	Adapter – 5/8" Barb x 3/4" MIPT, pack of 2	PK	1
701-043	Adapter – 3/8" Barb x 3/4" MIPT, pack of 2	PK	1

Female Adapter (Barb x FIPT)



701-006

CATALOG NO.	DESCRIPTION	UOM	ORDER MULTIPLE
701-006	Adapter – 3/4" Barb x 3/4" NPT, pack of 2	PK	1
701-041	Adapter – 1/2" Barb x 1/2" NPT, pack of 2	PK	1

Bushing (MIPT x FIPT)



701-015

CATALOG NO.	DESCRIPTION	UOM	ORDER MULTIPLE
701-015	Bushing – 1" MIPT x 3/4" FIPT, pack of 2	PK	1
701-017	Bushing – 3/4" MIPT x 1/2" FIPT, pack of 2	PK	1

Garden Hose Adapters



701-009

CATALOG NO.	DESCRIPTION	UOM	ORDER MULTIPLE
701-009	Adapter – 3/4" MGHT x 3/4" FIPT, pack of 2 PK	1	
701-011	Adapter – 3/4" MIPT x 3/4" FGHT, pack of 2 PK	1	

*All fittings packaged with identification. To order nylon fittings in bulk, enter catalog number followed by the letter "B." For example, 701-001B is the bulk part number for 701-001. Bulk sold in packs of 100.

Elbow (Barb x Barb)



CATALOG NO.	DESCRIPTION	UOM	ORDER MULTIPLE
701-018	Elbow – 1/2" Barb, pack of 2	PK	1
701-023	Elbow – 3/4" Barb, pack of 2	PK	1
701-040	Elbow – 5/8" Barb, pack of 2	PK	1
701-046	Elbow – 3/8" Barb, pack of 2	PK	1

Male Adapter Elbow (Barb x MIPT)



CATALOG NO.	DESCRIPTION	UOM	ORDER MULTIPLE
701-020	Elbow – 1/2" Barb x 3/4" MIPT, pack of 2	PK	1
701-025	Elbow – 3/4" Barb x 3/4" MIPT, pack of 2	PK	1
701-028	Elbow – 5/8" Barb x 3/4" MIPT, pack of 2	PK	1

Tee (Barb x Barb x Barb)



CATALOG NO.	DESCRIPTION	UOM	ORDER MULTIPLE
701-034	Tee – 1/2" Barb, pack of 2	PK	1
701-035	Tee – 1/2" x 3/4" x 1/2" Barb, pack of 2	PK	1
701-037	Tee – 3/4" Barb, pack of 2	PK	1
701-038	Tee – 3/8" Barb, pack of 2	PK	1
701-039	Tee – 5/8" Barb, pack of 2	PK	1

Female Adapter Elbow (Barb x FIPT)



CATALOG NO.	DESCRIPTION	UOM	ORDER MULTIPLE
701-019	Elbow – 1/2" Barb x 3/4" NPT, pack of 2	PK	1

Hose Mender (Barb x Barb)



CATALOG NO.	DESCRIPTION	UOM	ORDER MULTIPLE
701-029	Hose Mender – 1/2" Barb, pack of 2	PK	1
701-030	Hose Mender – 1/4" Barb, pack of 2	PK	1
701-031	Hose Mender – 3/4" Barb, pack of 2	PK	1
701-032	Hose Mender – 3/8" Barb, pack of 2	PK	1
701-033	Hose Mender – 5/8" Barb, pack of 2	PK	1

*All fittings packaged with identification. To order nylon fittings in bulk, enter catalog number followed by the letter "B." For example, 701-001B is the bulk part number for 701-001. Bulk sold in packs of 100.

OATEY® PRODUCTS

PVC Cement – Clear

PVC Cement is clear. All cans have brush-top applicator.



5-12

CATALOG NO.	DESCRIPTION	UOM	ORDER MULTIPLE
5-14	Oatey #31012 – 1/4 Pint	EA	24
5-12	Oatey #31013 – 1/2 Pint	EA	24
5-10	Oatey #31014 – 1 Pint	EA	24
5-32	Oatey #31015 – 32 oz.	EA	12

Purple Primer for PVC Pipe and Fittings (Black Label)

Recommended for all PVC and CPVC installations – all sizes/schedules. Purple tinted primer formulated to remove surface dirt and grease as well as soften the pipe surface to allow for a fast, secure and permanent solvent weld. For use in areas where codes call for primer verification.



530-30756

CATALOG NO.	DESCRIPTION	UOM	ORDER MULTIPLE
530-30755	Purple Primer – 4 oz.	EA	24
530-30756	Purple Primer – 8 oz.	EA	24
530-30757	Purple Primer – 16 oz.	EA	24

NSF and UPC listed. Exceeds ASTM F-656.

Heavy Duty PVC Cement

Heavy bodied clear cement recommended for use on PVC pipe and fittings up to 12" in diameter for Sch. 40 and Sch. 80 potable water pressure pipe, gas, conduit, drain waste and vent pipe. Exceeds ASTM D-2564.



530-30863

CATALOG NO.	DESCRIPTION	UOM	ORDER MULTIPLE
530-30850	Heavy Duty Cement – 4 oz.	EA	24
530-30863	Heavy Duty Cement – 8 oz.	EA	24
530-30876	Heavy Duty Cement – 16 oz.	EA	24

Rain-R-Shine Blue Cement

Medium bodied blue colored cement for PVC pipe and fittings up to 6 inches in diameter. A very fast setting cement formulated for wet conditions and/or when quick pressurization and fast installation is needed. Exceeds ASTM D-2564.



530-30891

CATALOG NO.	DESCRIPTION	UOM	ORDER MULTIPLE
530-30890	Rain-R-Shine Cement – 4 oz.	EA	24
530-30891	Rain-R-Shine Cement – 8 oz.	EA	24
530-30893	Rain-R-Shine Cement – 16 oz.	EA	24

Medium Orange CPVC Cement

Medium Orange CPVC Cement is formulated for use on all schedules and classes of CPVC pipe and fittings up to 6" diameter with interference fit.



530-11029

CATALOG NO.	DESCRIPTION	UOM	ORDER MULTIPLE
530-11029	Medium Orange CPVC Cement – 4 oz.	EA	24

PVC Primer – Clear

Recommended for all PVC and CPVC applications. Can be used on all sizes and schedules. Formulated to remove all surface dirt, grease, and grime as well as soften the pipe in preparation for solvent cement. This primer can be used when you want a cleaner installation. Meets ASTM F-656 and is NSF listed.



530-30752

CATALOG NO.	DESCRIPTION	UOM	ORDER MULTIPLE
530-30752	PVC Primer – Clear – 16 oz.	EA	24

All-Purpose Clear Cement for ABS, PVC and CPVC Pipe and Fittings

Heavy-bodied clear cement recommended for use on ABS, PVC, and CPVC pipe and fittings up to 12" in diameter. Flows freely and provides a thick layer of cement on the pipe. Apply at temperatures 40° to 90°F.

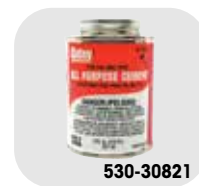

530-30821

CATALOG NO.	DESCRIPTION	UOM	ORDER MULTIPLE
530-30818	Clear Cement – 4 oz.	EA	24
530-30821	Clear Cement – 8 oz.	EA	24
530-30834	Clear Cement – 16 oz.	EA	24

PVC Gray Cement for High Efficiency Furnaces, Vent and Make-Up Air

Medium-bodied gray colored cement for use on Sch. 40 conduit, drain waste, and vent pipe. Flows freely and covers with a thicker layer than regular PVC. Can be applied at temperatures 40° to 100°F.

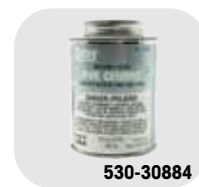

530-30884

CATALOG NO.	DESCRIPTION	UOM	ORDER MULTIPLE
530-30884	Gray Cement – 8 oz.	EA	24
530-30885	Gray Cement – 16 oz.	EA	24

NSF and UPC listed. Exceeds ASTM D-2564.

All Weather PVC Cement

Medium bodied cement for PVC pipe and fittings up to 6". Formulated for fast initial set-up from -15°F to 100°F. Exceeds ASTM D-2564.



530-31132

CATALOG NO.	DESCRIPTION	UOM	ORDER MULTIPLE
530-31132	All Weather Cement – 16 oz.	EA	24

Clear Cleaner

Clear Cleaner is a simple and effective cleaner formulated for ABS, PVC and CPVC pipe and fittings that flows freely and evaporates quickly.



530-10202

CATALOG NO.	DESCRIPTION	UOM	ORDER MULTIPLE
530-10202	Clear Cleaner – 16 oz.	EA	24
530-10203	Clear Cleaner – 8 oz.	EA	24

PVC PRIMER AND CEMENT

Pro-Weld™ PVC Cement (Regular Body)

Pro-Weld™ PVC Cement is a clear, regular bodied solvent cement designed to be used on Type I and II PVC pipe and fittings up to and including 4 inch diameter. Pro-Weld™ meets ASTM Standard D-2564.



CATALOG NO.	DESCRIPTION	UOM	ORDER MULTIPLE
PW-4	Pro-Weld™ – 4 oz. Brush-Top Container – Regular Body	EA	24
PW-8	Pro-Weld™ – 8 oz. Brush-Top Container – Regular Body	EA	24
PW-16	Pro-Weld™ – 16 oz. Brush-Top Container – Regular Body	EA	24
PW-32	Pro-Weld™ – 32 oz. Brush-Top Container – Regular Body	EA	12

Pro-Weld™ PVC Cement (Heavy Body)

Pro-Weld™ Heavy Body is a clear, heavy bodied, very high strength industrial grade PVC cement. It has a medium setting time and works with all rigid schedule 40 and 80 pipe diameters up to 12 inches. Complies with ASTM D2564 and NSF.



CATALOG NO.	DESCRIPTION	UOM	ORDER MULTIPLE
PWH-4	Pro-Weld™ – 4 oz. Brush-Top Container – Heavy Body	EA	24
PWH-8	Pro-Weld™ – 8 oz. Brush-Top Container – Heavy Body	EA	24
PWH-16	Pro-Weld™ – 16 oz. Brush-Top Container – Heavy Body	EA	24

Pro-Weld™ PVC Cement (Pool and Turf – Blue)

Pro-Weld™ Blue Pool and Turf is a blue colored, medium bodied, high strength PVC cement for welding rigid or flexible PVC in wet conditions where the system needs to be pressurized quickly. Pro-Weld Blue Pool and Turf sets up very fast and works with all rigid and flexible schedule 40 and 80 pipe diameters up to 6 inches. Complies with ASTM D2564 and NSF.



CATALOG NO.	DESCRIPTION	UOM	ORDER MULTIPLE
PWB-4	Pro-Weld™ – 4 oz. Brush-Top Container – Pool and Turf – Blue	EA	24
PWB-8	Pro-Weld™ – 8 oz. Brush-Top Container – Pool and Turf – Blue	EA	24
PWB-16	Pro-Weld™ – 16 oz. Brush-Top Container – Pool and Turf – Blue	EA	24

Un-Purple Primer

Hercules® Un-Purple Primer is formulated for use on all schedules and classes of PVC pipe and fittings. It appears clear, but shows purple under UV light. It makes every installation clean and look professional.



CATALOG NO.	DESCRIPTION	UOM	ORDER MULTIPLE
530-60445	Hercules® Un-Purple Primer, 16 oz.	EA	1

Pro-Weld™ PVC Cement (Universal – PVC/ABS/CPVC)

Pro-Weld™ Universal Cement is a clear, medium bodied, high strength cement for use on PVC to PVC, CPVC to CPVC, and ABS to ABS connections. Pro-Weld Universal sets up fast and works with all rigid schedule 40 and 80 piping up to 6 inches in diameter. Complies with ASTM D2564, D2235, and F493.



CATALOG NO.	DESCRIPTION	UOM	ORDER MULTIPLE
PWU-4	Pro-Weld™ – 4 oz. Brush-Top Container – Universal – PVC/ABS/CPVC	EA	24
PWU-8	Pro-Weld™ – 8 oz. Brush-Top Container – Universal – PVC/ABS/CPVC	EA	24
PWU-16	Pro-Weld™ – 16 oz. Brush-Top Container – Universal – PVC/ABS/CPVC	EA	24

Pro-Prime™ PVC Primer (Purple)

A purple-tinted primer formulated to remove dirt and oil from the surface of Type I and II PVC piping, as well as soften the piping in preparation for solvent welding. Pro-Prime™ contains purple pigment which provides verification that the primer has been applied to the pipe surface. Pro-Prime™ meets ASTM Standard F-656.



CATALOG NO.	DESCRIPTION	UOM	ORDER MULTIPLE
PP-4	Pro-Prime™ – 4 oz. Brush-Top Container	EA	24
PP-8	Pro-Prime™ – 8 oz. Brush-Top Container	EA	24
PP-16	Pro-Prime™ – 16 oz. Brush-Top Container	EA	24
PP-32	Pro-Prime™ – 32 oz. Can	EA	12

Pro-Prime™ Clear PVC Primer

Clear primer that removes dirt and oil from the surface of Type I and II PVC piping. Softens the piping to prepare for solvent welding. Pro-Prime Clear primer meets ASTM Standard F-656.



CATALOG NO.	DESCRIPTION	UOM	ORDER MULTIPLE
PPC-4	Pro-Prime™ Clear – 4 oz. Brush-Top Container	EA	24
PPC-8	Pro-Prime™ Clear – 8 oz. Brush-Top Container	EA	24
PPC-16	Pro-Prime™ Clear – 16 oz. Brush-Top Container	EA	24

Pro-Weld™ Weather-ALL

Pro-Weld™ PVC Cement is a clear, regular bodied solvent cement designed to be used on Type I and II PVC pipe and fittings up to and including 4 inch diameter. Pro-Weld™ meets ASTM Standard D-2564 and is usable in cold weather to -15°F and hot weather to 110°F.

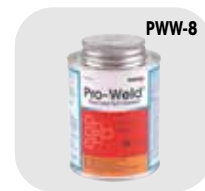

CATALOG NO.	DESCRIPTION	UOM	ORDER MULTIPLE
PWW-4	Pro-Weld™ – 4 oz. Brush-Top Container – All Weather Regular Body	EA	24
PWW-8	Pro-Weld™ – 8 oz. Brush-Top Container – All Weather Regular Body	EA	24
PWW-16	Pro-Weld™ – 16 oz. Brush-Top Container – All Weather Regular Body	EA	24

PVC CONDENSATE PIPE

Polyvinyl Chloride, White PVC 1120

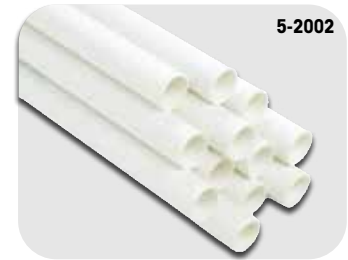

CATALOG NO.	DESCRIPTION	UOM	ORDER MULTIPLE
5-2002	3/4" PVC – PSI 200 – 10' Straight End	EA	500'
5-2005	3/4" PVC – PSI 200 – 20' Belled End	EA	500'
5-407	3/4" PVC – Sch. 40 – 20' Belled End	EA	500'
5-404	2" PVC – Sch.40/DWW,ASTM 2665 – 10' Straight End	EA	100'
5-405	3" PVC – Sch.40/DWW,ASTM 2665 – 10' Straight End	EA	50'
5-416	1" PVC – Sch. 40 – 20' Belled End	EA	200'
5-417	1-1/4" PVC – Sch. 40 – 20' Belled End	EA	200'
5-418	1-1/2" PVC – Sch. 40 – 20' Belled End	EA	200'

PVC DWV FITTINGS

Couplings (Hub x Hub)



CATALOG NO.	DESCRIPTION	UOM	ORDER MULTIPLE
5-100020	2" Couplings (Hub x Hub)	EA	100
5-100030	3" Couplings (Hub x Hub)	EA	60
510-D102338	3" x 2" Couplings (Hub x Hub)	EA	20

90 Elbow (Hub x Hub)



CATALOG NO.	DESCRIPTION	UOM	ORDER MULTIPLE
5-300020	2" 90 Elbow (Hub x Hub)	EA	50
5-300030	3" 90 Elbow (Hub x Hub)	EA	25
510-D304020	2" Long Sweep 90 Elbow (Hub x Hub)	EA	25
510-D304030	3" Long Sweep 90 Elbow (Hub x Hub)	EA	10

45 Elbows



CATALOG NO.	DESCRIPTION	UOM	ORDER MULTIPLE
5-321020	2" 45 Elbow (Hub x Hub)	EA	50
5-321030	3" 45 Elbow (Hub x Hub)	EA	20
510-D323020	2" 45 Street Elbow (Hub x SPIG)	EA	50
510-D323030	3" 45 Street Elbow (Hub x SPIG)	EA	20

DWV Bend Fittings



CATALOG NO.	DESCRIPTION	UOM	ORDER MULTIPLE
510-D309020	2" Long Sweep (Hub x SPIG)	EA	25
510-D309030	3" Long Sweep (Hub x SPIG)	EA	20

DWV Vent Tee



CATALOG NO.	DESCRIPTION	UOM	ORDER MULTIPLE
510-D441020	2" Vent Tee	EA	25

DWV Bushings



CATALOG NO.	DESCRIPTION	UOM	ORDER MULTIPLE
510-437338	3" x 2" Reducing Bushing (SPIG x SLIP)	EA	10
510-438338	3" x 2" Bushing (SPIG x FIPT)	EA	10

PVC SCHEDULE 40 PRESSURE FITTINGS

Tee (Slip x Slip x Slip)



CATALOG NO.	DESCRIPTION	UOM	ORDER MULTIPLE
5-401005	1/2" Tee	EA	50
5-401007	3/4" Tee	EA	50
5-401010	1" Tee	EA	50
5-401020	2" Tee	EA	25
5-401030	3" Tee	EA	10

90 Ell (Slip x Slip)

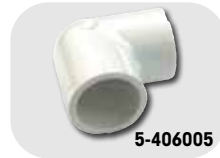

CATALOG NO.	DESCRIPTION	UOM	ORDER MULTIPLE
5-406005	1/2" 90 Ell	EA	50
5-406007	3/4" 90 Ell	EA	50
5-406010	1" 90 Ell	EA	50
5-406020	2" 90 Ell	EA	25
5-406030	3" 90 Ell	EA	10

90 Ell (Slip x FIPT)



CATALOG NO.	DESCRIPTION	UOM	ORDER MULTIPLE
5-407005	1/2" 90 Ell	EA	50
5-407007	3/4" 90 Ell	EA	50

90 Street Ell (SPIG x Slip)



CATALOG NO.	DESCRIPTION	UOM	ORDER MULTIPLE
5-409005	1/2" 90 Street Ell	EA	50
5-409007	3/4" 90 Street Ell	EA	50
5-409010	1" 90 Street Ell	EA	50

Tee (Slip x FIPT x Slip)



CATALOG NO.	DESCRIPTION	UOM	ORDER MULTIPLE
5-402007	3/4" Tee (S x S x FIPT)	EA	50

Traps

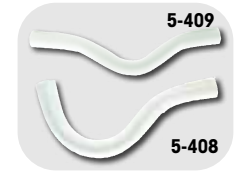

CATALOG NO.	DESCRIPTION	UOM	ORDER MULTIPLE
5-408	3/4" "P" Trap	EA	100
5-409	3/4" Running Trap	EA	100
5-410	3/4" Mini "P" Trap	EA	100
5-411	1" "P" Trap	EA	50
5-412	1/2" "P" Trap	EA	100
5-414	3/4" "J" Trap	EA	100

90 Ell Reducing (Slip x FIPT)

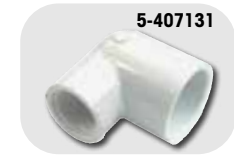

CATALOG NO.	DESCRIPTION	UOM	ORDER MULTIPLE
5-407131	1" x 3/4" 90 Ell Reducing	EA	50

45 Ell (Slip x Slip)



CATALOG NO.	DESCRIPTION	UOM	ORDER MULTIPLE
5-417005	1/2" 45 Ell	EA	50
5-417007	3/4" 45 Ell	EA	50
5-417010	1" 45 Ell	EA	50
5-417012	1-1/4" 45 Ell	EA	25
5-417020	2" 45 Ell	EA	25
5-417030	3" 45 Ell	EA	10

PVC SCHEDULE 40 PRESSURE FITTINGS cont'd

Plug (Slip)



CATALOG NO.	DESCRIPTION	UOM	ORDER MULTIPLE
5-449007	3/4" Plug	EA	50
5-449030	3" Plug	EA	10

90 Street Ell (MIPT x Slip)



CATALOG NO.	DESCRIPTION	UOM	ORDER MULTIPLE
5-410005	1/2" 90 Street Ell	EA	50
5-410007	3/4" 90 Street Ell	EA	50
5-410010	1" 90 Street Ell	EA	50

Female Adapter (Slip x FIPT)



CATALOG NO.	DESCRIPTION	UOM	ORDER MULTIPLE
5-435005	1/2" Female Adapter	EA	100
5-435007	3/4" Female Adapter	EA	50
5-435010	1" Female Adapter	EA	50

Female Adapter Reducing (Slip x FIPT)



CATALOG NO.	DESCRIPTION	UOM	ORDER MULTIPLE
5-435101	3/4" x 1/2" Female Adapter Reducing	EA	50
5-435102	3/4" x 1" Female Adapter Reducing	EA	50

Coupling (Slip x Slip)



CATALOG NO.	DESCRIPTION	UOM	ORDER MULTIPLE
5-429005	1/2" Coupling	EA	100
5-429007	3/4" Coupling	EA	50
5-429010	1" Coupling	EA	50
5-429015	1-1/2" Coupling	EA	25
5-429020	2" Coupling	EA	25
5-429030	3" Coupling	EA	10

Cap (Slip)



CATALOG NO.	DESCRIPTION	UOM	ORDER MULTIPLE
5-447007	3/4" Cap	EA	100
5-447010	1" Cap	EA	100

Male Adapter (MIPT x Slip)



CATALOG NO.	DESCRIPTION	UOM	ORDER MULTIPLE
5-436005	1/2" Male Adapter	EA	100
5-436007	3/4" Male Adapter	EA	50
5-436010	1" Male Adapter	EA	50

Plug (MIPT)



CATALOG NO.	DESCRIPTION	UOM	ORDER MULTIPLE
5-450007	3/4" Plug	EA	50

Male Adapter Reducing (MIPT x Slip)



CATALOG NO.	DESCRIPTION	UOM	ORDER MULTIPLE
5-436074	1/2" x 3/4" Male Adapter Reducing	EA	50
5-436101	3/4" x 1/2" Male Adapter Reducing	EA	50
5-436102	3/4" x 1" Male Adapter Reducing	EA	50
5-436131	1" x 3/4" Male Adapter Reducing	EA	50

Reducer Bushing (SPIG x Slip)



CATALOG NO.	DESCRIPTION	UOM	ORDER MULTIPLE
5-437101	3/4" x 1/2" Reducer Bushing	EA	100
5-437130	1" x 1/2" Reducer Bushing	EA	100
5-437131	1" x 3/4" Reducer Bushing	EA	100
5-437210	1-1/2" x 3/4" Reducer Bushing	EA	25

Reducer Bushing (SPIG X FIPT)



CATALOG NO.	DESCRIPTION	UOM	ORDER MULTIPLE
5-438101	3/4" x 1/2" Reducer Bushing	EA	100
5-438131	1" x 3/4" Reducer Bushing	EA	100

Cap (FIPT)



CATALOG NO.	DESCRIPTION	UOM	ORDER MULTIPLE
5-448007	3/4" Cap	EA	100

Adapter (Insert x Slip)



CATALOG NO.	DESCRIPTION	UOM	ORDER MULTIPLE
5-474007	3/4" Adapter (Insert x Slip)	EA	50

Clean Out Tee



CATALOG NO.	DESCRIPTION	UOM	ORDER MULTIPLE
510-3400-10	3/4" Clean Out Tee	EA	10
510-3400	3/4" Clean Out Tee	EA	50

SUPPORTS

Plastic DWV J-Hooks



CATALOG NO.	DESCRIPTION	UOM	ORDER MULTIPLE
515-J2000	2" x 9" DWV Swiveling J-Hook	EA	25
515-J3000	3" x 7-1/2" DWV Swiveling J-Hook	EA	25

TUBING, CLAMPS, AND KITS

Polyethylene Tubing

F.D.A. approved, flexible, non-toxic tubing. Tasteless and odorless, lightweight, low density. Ideal for drinking water lines, evaporative coolers, and radiant heating.



CATALOG NO.	DESCRIPTION	UOM	ORDER MULTIPLE
PE-104	Polyethylene Tubing - 1 1/64ID, 1/4OD, 100FT	EA	1
PE-012	Polyethylene Tubing - 3/8ID, 1/2OD, 100FT	EA	1
PE-014	Polyethylene Tubing - 1/8ID, 1/4OD, 100FT	EA	1
PE-038	Polyethylene Tubing - 1/4ID, 3/8 OD, 100FT	EA	1
PE-058	Polyethylene Tubing - 1/2ID, 5/8OD, 100FT	EA	1

Icemaker Kit

Supplies water to most refrigerators with automatic icemakers, humidifiers and evaporative coolers. Contains self-tapping valve and all necessary fittings.



CATALOG NO.	DESCRIPTION	UOM	ORDER MULTIPLE
750-401	Icemaker Kit - Poly Tube - 25'	EA	1
750-402	Icemaker Kit - Copper - 25'	EA	1

Hose Clamps

Partial stainless, worm drive, adjustable. 300 series stainless steel 1/2" band with plated 5/16" slotted hex head screw and housing, except the B-4H which has a 5/16" band and 1/4" nut. Recommended for most applications. 100% interlock construction features one-piece housing which directly locks into band. Spot weld free design.



CATALOG NO.	DESCRIPTION	UOM	ORDER MULTIPLE
B-4H	No. 4, 7/32" - 5/8" dia., 3/16" - 5/16" hose I.D.	EA	10
B-6H	No. 6, 7/16" - 25/32" dia., 1/4" - 3/8" hose I.D.	EA	10
B-8H	No. 8, 1/2" - 29/32" dia., 5/16" - 1/2" hose I.D.	EA	10
B-10H	No. 10, 9/16" - 1-1/16" dia., 3/8" - 5/8" hose I.D.	EA	10
B-12H	No. 12, 11/16" - 1-1/4" dia., 5/8" - 3/4" hose I.D.	EA	10
B-16H	No. 16, 13/16" - 1-1/2" dia., 3/4" - 1" hose I.D.	EA	10
B-20H	No. 20, 13/16" - 1-3/4" dia., 1" - 1-1/4" hose I.D.	EA	10
B-24H	No. 24, 1-1/16" - 2" dia., 1-1/4" - 1-1/2" hose I.D.	EA	10
B-28H	No. 28, 1-5/16" - 2-1/4" dia., 1-1/4" - 1-3/4" hose I.D.	EA	10
B-32H	No. 32, 1-9/16" - 2-1/2" dia., 1-1/2" - 2" hose I.D.	EA	10
B-36H	No. 36, 1-13/16" - 2-3/4" dia., 1-3/4" - 2-1/4" hose I.D.	EA	10
B-48H	No. 48, 2-9/16" - 3-1/2" dia., 1-3/4" - 2-1/4" hose I.D.	EA	10
B-72H	No. 72, 1-7/8" - 5" dia., 1-3/4" - 2-1/4" hose I.D.	EA	10

Self Tapping Water Valve

Installs on all copper tube lines from 3/8" O.D. to 1-1/8" O.D. without shutting off water. No drilling required. Features 1/4" compression fitting. Stainless steel piercing needle. Special molded gasket seals on both tubing and valve. Will not slip or turn on tubing.



CATALOG NO.	DESCRIPTION	UOM	ORDER MULTIPLE
QAV-2	Self Tapping Water Tap Valve	EA	1

DUCTLESS SYSTEMS

EasyGuard™ Fittings	151-152
EasyGuard™ Line Set Cover System	151
Line Set Cutting Tools.....	150
Roof Inlets.....	150
SpeediChannel™ Fittings	147-150
SpeediChannel™ Line Set Cover System	147

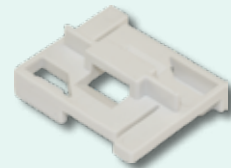

DiversiTech® SpeediChannel™ System

SIZING CHART AND SELECTION INFORMATION

Maximum Line Set, Drain Pipe, and Cable Capacity using 3/8" Insulation

Model	230-D3	230-D4	230-D6
Dimensions	3" x 2-1/2"	4" x 2-3/4"	6" x 3"
Length	78"	78"	78"

Mini-Split Systems – Liquid and Suction Line with 3/8" Insulation

Liquid Line	3/8"	2 x 1/4"	1 x 1/4" + 2 x 3/8"
Suction Line	5/8"	2 x 3/8"	1 x 1/2" + 2 x 5/8"
Drain Hose	3/4" OD	2 x 3/4" OD	3 x 3/4" OD
Power Cable	1 x UF 14-3	2 x 1/2" SealTite	3 x 1/2" SealTite
Control Cable	1 Pair 18 AWG	2 Pairs 18 AWG	3 Pairs 18 AWG
Nominal Tonnage	1–3 Tons	1x3 Ton or 2x1 Ton	1x3 Ton or 2x2 Ton

Conventional Split Systems – Liquid Line Plain, Suction Line with 3/8" Insulation

Liquid Line	3/8"	3/8"	3/8"
Suction Line	3/4" or 7/8"	1-1/8"	1-1/8"
Drain Hose	3/4" PVC	3/4" PVC	3/4" PVC
Power Cable	1 x UF 14-2	1 x 1/2" SealTite	1 x 1/2" SealTite
Control Cable	1 Pair 18 AWG	1 Pair 18 AWG	1 Pair 18 AWG
Nominal Tonnage	Up to 3.5 Tons	4–5 Tons	7.5 Tons and up

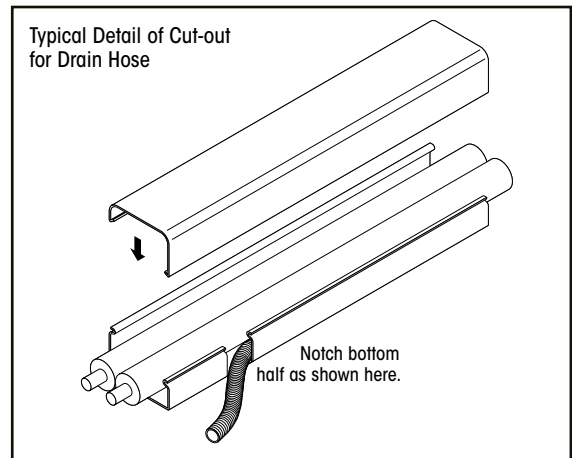
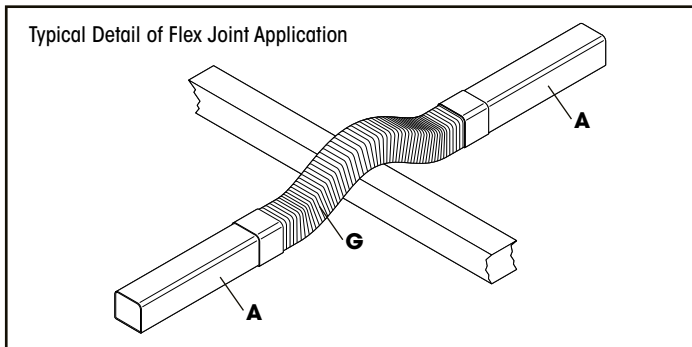
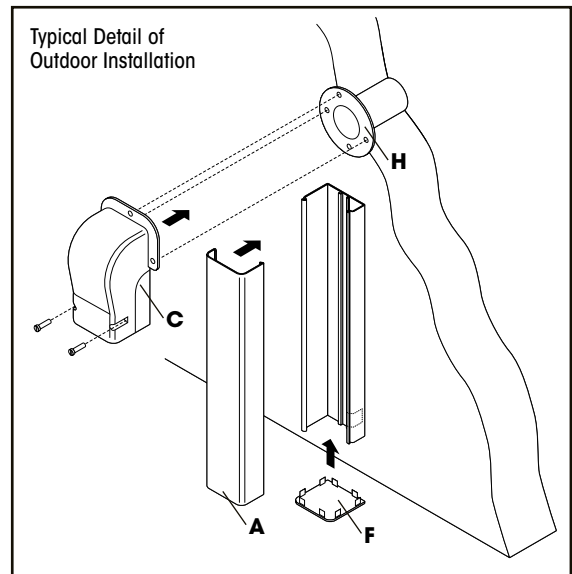
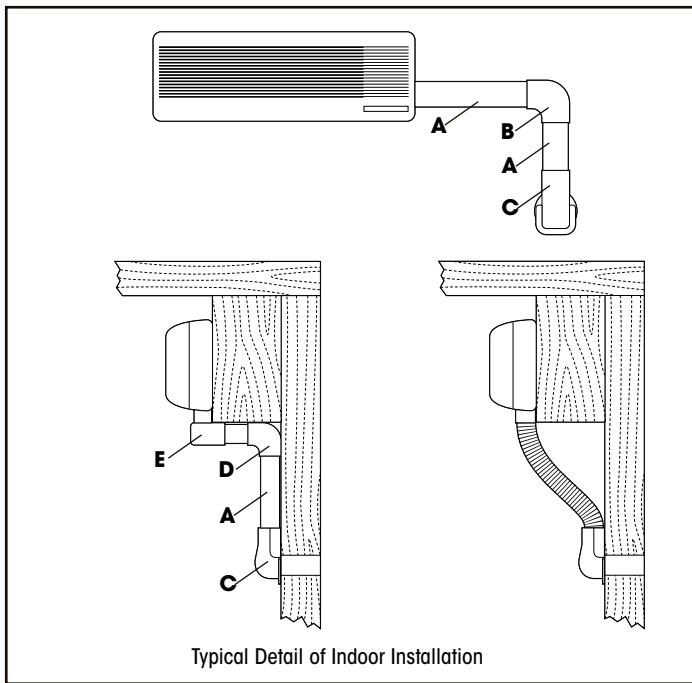

- A - 230-D
- B - 230-FB
- C - 230-WC
- D - 230-EB
- E - 230-EIN
- F - 230-DC
- G - 230-FJ
- H - 230-WS2

NOTE:
Suffix parts A-G
with the duct
size needed
(3,4, or 6)

DiversiTech® SpeediChannel™ System

TECHNICAL SPECIFICATIONS

Color	Natural, Brown or White in select 3" & 4" sizes			
Size	230-D3: 3" x 2-1/2" OD	230-D4: 4" x 2-3/4" OD	230-D6: 6" x 3-1/8" OD	Standard Length: 78"
Material	Weather Resistant PVC, UV Stabilized and Fire Resistant			
Fire Rating	Meets UL 94V-0			
Temperature Range	-4°F TO 140°F			
Weather Resistance	Tested to over 2,000 hours			
Fixing Screws	Stainless Steel			

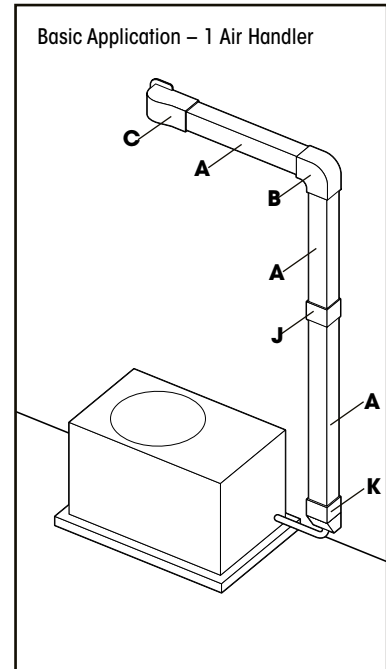
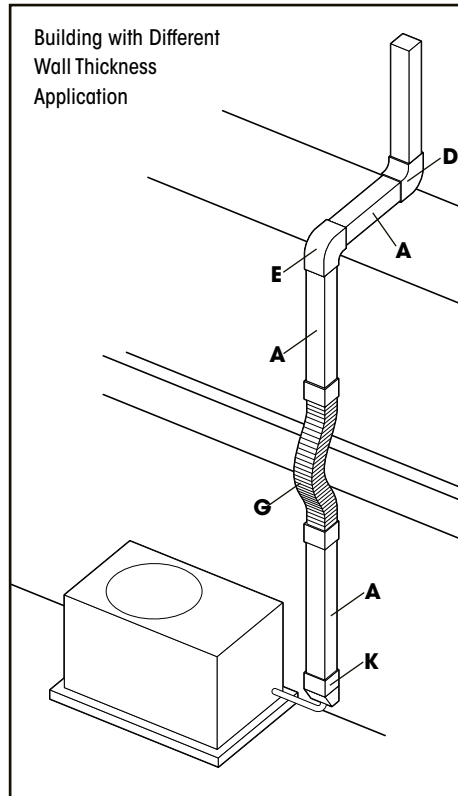
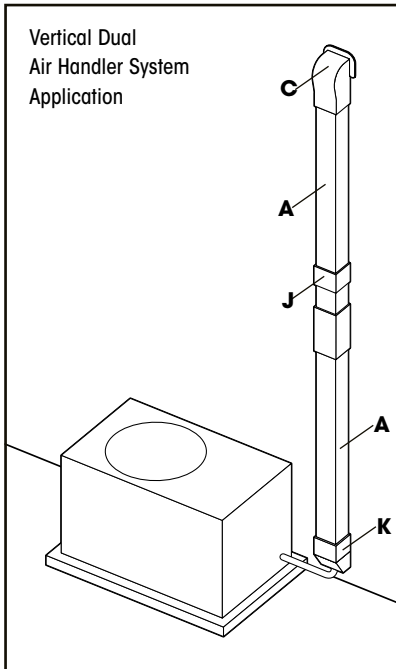
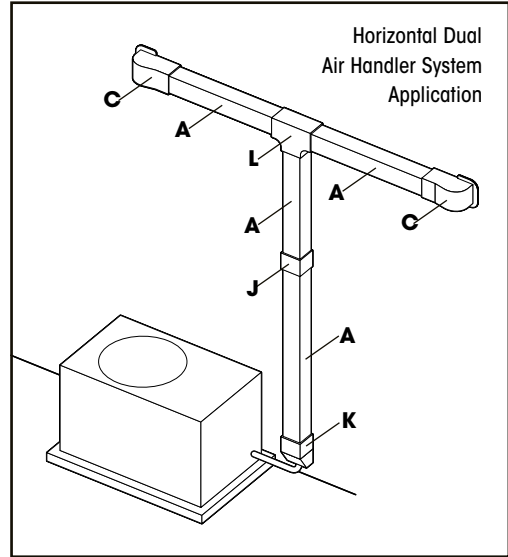
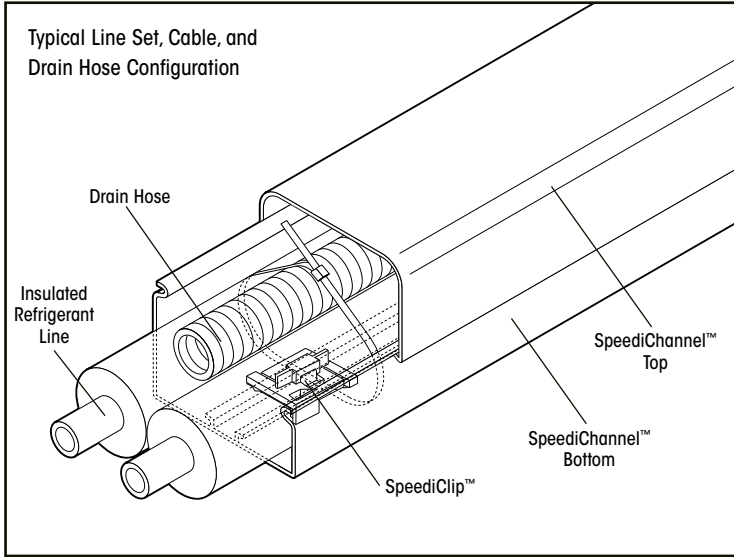

- A - 230-D
- B - 230-FB
- C - 230-WC
- D - 230-EB
- E - 230-EIN
- F - 230-DC
- G - 230-FJ
- H - 230-WS2
- J - 230-CP
- K - 230-DE
- L - 230-TC

NOTE:
Suffix parts A-G
with the duct
size needed
(3, 4, or 6)

SpeediChannel™ System Installation

Step 1

Attach the SpeediChannel™ base to the wall about every 15 inches with screws suitable for the wall construction (siding, stucco, brick, etc.). Screw through the center of the molded rail. Slide the connecting piece (elbow, union, tee, etc.) under the SpeediChannel™ before attaching the end of the channel to the wall. When cutting lengths of SpeediChannel™, allow 1/8" gap between the end of the SpeediChannel™ and the stop inside the fitting to allow for thermal expansion.



Step 4

Attach the SpeediChannel™ to the base.



Step 2

Attach one SpeediClip™ with cable tie about every 20 inches along the inside sliding rail.



Step 5

Attach the fitting covers with the screws provided.



Step 3

Install the line set, drain line, and wires inside the SpeediChannel™. Test the equipment installation prior to tightening the cable ties. Tighten the cable ties snug, but not so tight they damage the tubing insulation or kink the drain line. Trim excess length from the cable tie.



Step 6

When complete, paint the SpeediChannel™ to match surface of installation (if desired).



SPEEDICHANNEL™ LINE SET COVER SYSTEM

SpeediChannel™

The DiversiTech SpeediChannel™ is available in three widths, all in 6-1/2 feet lengths. Includes pack of SpeediClips™.



CATALOG NO.	DESCRIPTION	UOM	ORDER MULTIPLE
230-D3A	3" SpeediChannel™	EA	6
230-D3B	3" SpeediChannel™, Brown	EA	6
230-D3W	3" SpeediChannel™, White	EA	6
230-D4A	4" SpeediChannel™	EA	6
230-D4B	4" SpeediChannel™, Brown	EA	6
230-D4W	4" SpeediChannel™, White	EA	6
230-D6	6" SpeediChannel™	EA	5
230-D6W	6" SpeediChannel™, White	EA	5

Channel must ship LTL.

SPEEDICHANNEL™ FITTINGS

Adjustable Flat Bend

Adjustable flat bends flex from 45 to 90 degrees and make it easy to route the SpeediChannel™ around an obstacle. Each adjustable bend is individually packed and includes stainless steel screws.



CATALOG NO.	DESCRIPTION	ORDER UOM	ORDER MULTIPLE
230-AFB3	3in. Adjustable Flat Bend	EA	10
230-AFB3W	3in. Adjustable Flat Bend, White	EA	10
230-AFB4	4in. Adjustable Flat Bend	EA	10
230-AFB4W	4in. Adjustable Flat Bend, White	EA	10

Soffit Fittings

Ideal for outdoor applications where the SpeediChannel™ runs up an exterior wall and enters the house vertically through the soffit. Its large flat surface area easily covers the rough opening cut in the soffit. Furnished in two parts, the Soffit Fitting easily snaps onto the SpeediChannel™ for a clean installation.



CATALOG NO.	DESCRIPTION	ORDER UOM	ORDER MULTIPLE
230-SF3	3" Soffit Fitting	EA	10
230-SF3W	3" Soffit Fitting, White	EA	10
230-SF4	4" Soffit Fitting	EA	10
230-SF4W	4" Soffit Fitting, White	EA	10

Wall Penetration

Wall sleeves and penetration covers are used to transition from the SpeediChannel™ system to a through wall penetration. The wall sleeve creates a neat hole through the wall, and the line set is covered by the wall cover. DiversiTech's wall covers are designed to allow for easy installation - even after the line set has been installed. A unique hooking and fastening arrangement allows for quick and easy installation. Each wall cover is individually packed, and is furnished complete with stainless steel screws to attach the wall cover to the base. Three screws (supplied by others) are needed to fasten the wall cover to whatever type of wall construction the system is being installed on.



CATALOG NO.	DESCRIPTION	UOM	ORDER MULTIPLE
230-WC3	3" Wall Penetration Cover	EA	10
230-WC3B	3" Wall Penetration Cover, Brown	EA	10
230-WC3W	3" Wall Penetration Cover, White	EA	10
230-WC4	4" Wall Penetration Cover	EA	10
230-WC4B	4" Wall Penetration Cover, Brown	EA	10
230-WC4W	4" Wall Penetration Cover, White	EA	10
230-WC6	6" Wall Penetration Cover	EA	10
230-WC6W	6" Wall Penetration Cover, White	EA	10
230-WS2	2-1/2" Wall Sleeve	EA	10

90° Flat Bend

90° flat bends are used to route the SpeediChannel™ around an obstacle. Each bend is individually packed, and is furnished complete with stainless steel screws.



CATALOG NO.	DESCRIPTION	UOM	ORDER MULTIPLE
230-FB3	3" 90 degree Flat Bend	EA	10
230-FB3B	3" 90 degree Flat Bend, Brown	EA	10
230-FB3W	3" 90 degree Flat Bend, White	EA	10
230-FB4	4" 90 degree Flat Bend	EA	10
230-FB4B	4" 90 degree Flat Bend, Brown	EA	10
230-FB4W	4" 90 degree Flat Bend, White	EA	10
230-FB6	6" 90 degree Flat Bend	EA	10
230-FB6W	6" 90 degree Flat Bend, White	EA	10

SPEEDICHANNEL™ FITTINGS cont'd

90° Long Radius Bend

90° long radius flat bends are used to route the SpeediChannel™ around an obstacle. The long radius of the elbow allows a gentle bending radius on the copper line set. Each elbow is individually packed, and is furnished complete with stainless steel screws.



230-LFB4

CATALOG NO.	DESCRIPTION	UOM	ORDER MULTIPLE
230-LFB3	3" 90 degree Long Radius Bend	EA	10
230-LFB3B	3" 90 degree Long Radius Bend, Brown	EA	10
230-LFB3W	3" 90 degree Long Radius Bend, White	EA	10
230-LFB4	4" 90 degree Long Radius Bend	EA	10
230-LFB4B	4" 90 degree Long Radius Bend, Brown	EA	10
230-LFB4W	4" 90 degree Long Radius Bend, White	EA	10
230-LFB6	6" 90 degree Long Radius Bend	EA	10
230-LFB6W	6" 90 degree Long Radius Bend, White	EA	10

90° Inside Elbow

90° inside elbows are used to route the SpeediChannel™ around an inside corner. Each elbow is individually packed, and is furnished complete with stainless steel screws.



230-EB3



CATALOG NO.	DESCRIPTION	UOM	ORDER MULTIPLE
230-EB3	3" 90 degree Inside Elbow	EA	10
230-EB3B	3" 90 degree Inside Elbow, Brown	EA	10
230-EB3W	3" 90 degree Inside Elbow, White	EA	10
230-EB4	4" 90 degree Inside Elbow	EA	10
230-EB4B	4" 90 degree Inside Elbow, Brown	EA	10
230-EB4W	4" 90 degree Inside Elbow, White	EA	10
230-EB6	6" 90 degree Inside Elbow	EA	10
230-EB6W	6" 90 degree Inside Elbow, White	EA	10

Union Coupling

Used for joining two pieces of SpeediChannel™ — each cover being the same size. Each coupling is individually packed, and is furnished complete with stainless steel screws.



230-CP3



CATALOG NO.	DESCRIPTION	UOM	ORDER MULTIPLE
230-CP3	3" Union Coupling	EA	10
230-CP3B	3" Union Coupling, Brown	EA	10
230-CP3W	3" Union Coupling, White	EA	10
230-CP4	4" Union Coupling	EA	10
230-CP4B	4" Union Coupling, Brown	EA	10
230-CP4W	4" Union Coupling, White	EA	10
230-CP6	6" Union Coupling	EA	10
230-CP6W	6" Union Coupling, White	EA	10

45° Flat Bend

45° flat bends are used to route the SpeediChannel™ around an obstacle. Each bend is individually packed, and is furnished complete with stainless steel screws.



230-FB453

CATALOG NO.	DESCRIPTION	UOM	ORDER MULTIPLE
230-FB453	3" 45 degree Flat Bend	EA	10
230-FB453B	3" 45 degree Flat Bend, Brown	EA	10
230-FB453W	3" 45 degree Flat Bend, White	EA	10
230-FB454	4" 45 degree Flat Bend	EA	10
230-FB454B	4" 45 degree Flat Bend, Brown	EA	10
230-FB454W	4" 45 degree Flat Bend, White	EA	10
230-FB456	6" 45 degree Flat Bend	EA	10
230-FB456W	6" 45 degree Flat Bend, White	EA	10

90° Outside Elbow

90° outside elbows are used to route the SpeediChannel™ around an outside corner. Each elbow is individually packed, and is furnished complete with stainless steel screws.



230-EIN3



CATALOG NO.	DESCRIPTION	UOM	ORDER MULTIPLE
230-EIN3	3" 90 degree Outside Elbow	EA	10
230-EIN3B	3" 90 degree Outside Elbow, Brown	EA	10
230-EIN3W	3" 90 degree Outside Elbow, White	EA	10
230-EIN4	4" 90 degree Outside Elbow	EA	10
230-EIN4B	4" 90 degree Outside Elbow, Brown	EA	10
230-EIN4W	4" 90 degree Outside Elbow, White	EA	10
230-EIN6	6" 90 degree Outside Elbow	EA	10
230-EIN6W	6" 90 degree Outside Elbow, White	EA	10

T-Joint

Used for creating a tee connection between three pieces of SpeediChannel™ — all covers being the same size. The tee can be combined with the reducing coupling to join SpeediChannel™s of different sizes. Each tee is individually packed, and is furnished complete with stainless steel screws.



230-TJ4



CATALOG NO.	DESCRIPTION	UOM	ORDER MULTIPLE
230-TJ4	4" T-Joint	EA	10
230-TJ4B	4" T-Joint, Brown	EA	10
230-TJ4W	4" T-Joint, White	EA	10
230-TJ6	6" T-Joint	EA	10
230-TJ6W	6" T-Joint, White	EA	10

SPEEDICHANNEL™ FITTINGS cont'd

Flex Joint

An accordion style piece of SpeediChannel™, the flex joint can be extremely flexible routing a SpeediChannel™ system around virtually any type of obstacle. Each joint is 20" long and can be combined together for longer flex runs. Unlike competitor systems, the DiversiTech flex joint does NOT require the use of a union coupling. The DiversiTech flex joint slides tightly inside the SpeediChannel™ system.



230-FJ3

CATALOG NO.	DESCRIPTION	UOM	ORDER MULTIPLE
230-FJ3	3" Flex Joint	EA	10
230-FJ3W	3" Flex Joint, White	EA	10
230-FJ4	4" Flex Joint	EA	10
230-FJ4W	4" Flex Joint, White	EA	10

Duct End

The duct end is used to terminate a run of SpeediChannel™ to a small opening – just large enough for the line set and condensate drain line to pass through. Gives a neat/clean installation.



230-DE3 230-DE4



CATALOG NO.	DESCRIPTION	UOM	ORDER MULTIPLE
230-DE3	3" Duct End	EA	10
230-DE3B	3" Duct End, Brown	EA	10
230-DE3W	3" Duct End, White	EA	10
230-DE4	4" Duct End	EA	10
230-DE4B	4" Duct End, Brown	EA	10
230-DE4W	4" Duct End, White	EA	10
230-DE6	6" Duct End	EA	10
230-DE6W	6" Duct End, White	EA	10

Flat Wall Escutcheon

Typically used to cover a rough opening in a soffit, wall, or ceiling penetration. One side of the escutcheon is flat to allow for a SpeediChannel™ run going along a wall, and penetrating through an adjacent wall or ceiling. This is the most common type of wall penetration. Furnished in two parts, the escutcheon easily snaps onto the SpeediChannel™.



230-FR3



CATALOG NO.	DESCRIPTION	UOM	ORDER MULTIPLE
230-FR3	3" Flat Wall Escutcheon	EA	10
230-FR3W	3" Flat Wall Escutcheon, White	EA	10
230-FR4	4" Flat Wall Escutcheon	EA	10
230-FR4W	4" Flat Wall Escutcheon, White	EA	10
230-FR6	6" Flat Wall Escutcheon	EA	10
230-FR6W	6" Flat Wall Escutcheon, White	EA	10

Reducer Coupling

Used for joining two pieces of SpeediChannel™ — each cover being a different size. Each coupling is individually packed, and is furnished complete with stainless steel screws.



230-TC34



CATALOG NO.	DESCRIPTION	UOM	ORDER MULTIPLE
230-TC34	3" x 4" Reducer Coupling	EA	10
230-TC34W	3" x 4" Reducer Coupling, White	EA	10
230-TC46	4" x 6" Reducer Coupling	EA	10
230-TC46W	4" x 6" Reducer Coupling, White	EA	10

Cap

Used to cap the end of a SpeediChannel™ run. Easily snaps into the end of the SpeediChannel™.



230-DC3

CATALOG NO.	DESCRIPTION	UOM	ORDER MULTIPLE
230-DC3	3" Cap	EA	10
230-DC3W	3" Cap, White	EA	10
230-DC4	4" Cap	EA	10
230-DC4W	4" Cap, White	EA	10
230-DC6	6" Cap	EA	10
230-DC6W	6" Cap, White	EA	10

Wall Escutcheon

Typically used to cover a rough opening in a wall or ceiling penetration. The hole in the escutcheon is centered to allow for a free standing SpeediChannel™ to penetrate through a wall or ceiling. This is the fairly un-common type of wall or ceiling penetration. Check carefully, as you may need the Flat Wall Escutcheon. Furnished in two parts, the escutcheon easily snaps onto the SpeediChannel™.



230-WR3



CATALOG NO.	DESCRIPTION	UOM	ORDER MULTIPLE
230-WR3	3" Wall Escutcheon	EA	10
230-WR3W	3" Wall Escutcheon, White	EA	10
230-WR4	4" Wall Escutcheon	EA	10
230-WR4W	4" Wall Escutcheon, White	EA	10
230-WR6	6" Wall Escutcheon	EA	10
230-WR6W	6" Wall Escutcheon, White	EA	10

SPEEDICHANNEL™ FITTINGS cont'd

SpeediChannel™ Accessories

A variety of accessories that are complementary or required for installing DiversiTech's SpeediChannel™ system.

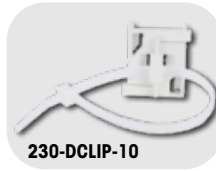

CATALOG NO.	DESCRIPTION	UOM	ORDER MULTIPLE
230-DCLIP-10	SpeediClip™ and 11" Cable Ties, pack of 10	PK	1
230-DCLIP	*SpeediClip™, pack of 50	PK	1
230-DSCREW	SpeediChannel™ screws, pack of 100	PK	1
WTB11C	Black Wire Ties – 11", pack of 100	PK	1

Universal Pump Elbow

The Universal Pump Elbow lets an installer use any mini pump of their choice and install it with SpeediChannel. Includes pump elbow and reservoir mounting brackets to fit most mini-split pumps.



CATALOG NO.	DESCRIPTION	UOM	ORDER MULTIPLE
230-PFB3	Universal Pump Elbow	EA	1

SpeediChannel™ Kits

The SpeediChannel™ Fitting Kit provides a simple mix of the basic fittings used in a typical SpeediChannel™ installation job. Included are one coupling, one wall penetration, one inside elbow, one long radius flat bend, and one pack of ten SpeediClips and 11" cable ties. The 230-IK3 and 230-IK4 Installation Kits include three 48" pieces of channel and selected fittings.



CATALOG NO.	DESCRIPTION	UOM	ORDER MULTIPLE
230-IK3	3" SpeediChannel™ Fitting Kit	EA	1
230-IK3W	3" SpeediChannel™ Fitting Kit, White	EA	1
230-IK4	4" SpeediChannel™ Fitting Kit	EA	1
230-IK4W	4" SpeediChannel™ Fitting Kit, White	EA	1
230-IK3	3" SpeediChannel™ Installation Kit	EA	1
230-IK3W	3" SpeediChannel™ Installation Kit, White	EA	1
230-IK4	4" SpeediChannel™ Installation Kit	EA	1
230-IK4W	4" SpeediChannel™ Installation Kit, White	EA	1

SpeediChannel™ Flex Hose Kits

A flexible hose kit of SpeediChannel that protects the line set from the condensing unit to the wall. Also provides a quick easy connection between two lengths of channel over or around obstacles. The kit comes with everything needed for a clean professional installation.



CATALOG NO.	DESCRIPTION	UOM	ORDER MULTIPLE
230-FH3-KIT	3" Flex Hose Kit	EA	1
230-FH3W-KIT	3" Flex Hose Kit, White	EA	1
230-FH4-KIT	4" Flex Hose Kit	EA	1
230-FH4W-KITW	4" Flex Hose Kit, White	EA	1

LINESET CUTTING TOOLS

Lineset Cover Cutter

The 230-CUTTER is designed to easily cut lineset covers that protect linesets and insulations in HVAC applications. The 230-CUTTER has a ratcheting cutting blade that makes cutting lineset covers easy and clean. It has cutting capacity for various duct sizes, ranging from 1.38" x 1.18" up to 3.54" x 2.55".

- Easy to open and close
- Cut cleanly with ratcheting blade
- Strong metal body and handle
- Safety hook to keep blade closed
- Lightweight and easy to carry



CATALOG NO.	DESCRIPTION	UOM	ORDER MULTIPLE
230-CUTTER	Lineset Cover Cutter	EA	1

ROOF INLETS

Roof Inlets

"Roof entrance" adapters for linesets are the ultimate solution for a professional flat roof installation. Manufactured from UV weather resistant plastics, the Roof Inlet combines a series of features:

- The Roof Inlet body part is equipped with a slope avoiding possible damage to the insulation and preventing kinks into the copper tubes.
- The Roof Inlet base holes allow a steady fixation (depending on the roof surface type and composition).
- The Roof Inlet cap is firmly fixed to the body with stainless steel bolts.



CATALOG NO.	DESCRIPTION	UOM	ORDER MULTIPLE
230-INJ465	SpeediChannel™ Roof Inlet – 5"	EA	2
230-INJ462	SpeediChannel™ Roof Inlet – 10"	EA	2

EASYGUARD™ LINE SET COVER SYSTEM

EasyGuard™

The DiversiTech EasyGuard™ is available in two widths, both in 6-1/2 feet lengths. Includes pack of SpeediClips™.

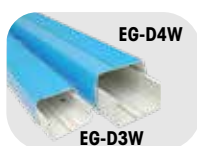

CATALOG NO.	DESCRIPTION	UOM	ORDER MULTIPLE
EG-D3W	3" EasyGuard - 6-1/2' long	EA	1
EG-D4W	4" EasyGuard - 6-1/2' long	EA	1

Channel must ship LTL.

EASYGUARD™ FITTINGS

Wall Penetration

Wall sleeves and penetration covers are used to transition from the EasyGuard™ system to a through wall penetration. The wall sleeve creates a neat hole through the wall, and the line set is covered by the wall cover. DiversiTech's wall covers are designed to allow for easy installation - even after the line set has been installed. A unique hooking and fastening arrangement allows for quick and easy installation. Each wall cover is individually packed, and is furnished complete with stainless steel screws to attach the wall cover to the base. Three screws (supplied by others) are needed to fasten the wall cover to whatever type of wall construction the system is being installed on.



CATALOG NO.	DESCRIPTION	UOM	ORDER MULTIPLE
EG-WC3W	3" Wall Penetration Cover	EA	1
EG-WC4W	4" Wall Penetration Cover,	EA	1

90° Inside Elbow

90° inside elbows are used to route the EasyGuard™ around an inside corner. Each elbow is individually packed, and is furnished complete with stainless steel screws.



CATALOG NO.	DESCRIPTION	UOM	ORDER MULTIPLE
EG-EB3W	3" 90 degree Inside Elbow	EA	1
EG-EB4W	4" 90 degree Inside Elbow, Brown	EA	1

Union Coupling

Used for joining two pieces of EasyGuard™—each cover being the same size. Each coupling is individually packed, and is furnished complete with stainless steel screws.



CATALOG NO.	DESCRIPTION	UOM	ORDER MULTIPLE
EG-CP3W	3" Union Coupling	EA	1
EG-CP4W	4" Union Coupling	EA	1

Soffit Fittings

Ideal for outdoor applications where the EasyGuard™ runs up an exterior wall and enters the house vertically through the soffit. Its large flat surface area easily covers the rough opening cut in the soffit. Furnished in two parts, the Soffit Fitting easily snaps onto the EasyGuard™ for a clean installation.



CATALOG NO.	DESCRIPTION	ORDER UOM	ORDER MULTIPLE
EG-SF3W	3" Soffit Fitting	EA	1
EG-SF4W	4" Soffit Fitting	EA	1

90° Flat Bend

90° flat bends are used to route the EasyGuard™ around an obstacle. Each bend is individually packed, and is furnished complete with stainless steel screws.



CATALOG NO.	DESCRIPTION	UOM	ORDER MULTIPLE
EG-FB3W	3" 90 degree Flat Bend	EA	1
EG-FB4W	4" 90 degree Flat Bend	EA	1

90° Outside Elbow

90° outside elbows are used to route the EasyGuard™ around an outside corner. Each elbow is individually packed, and is furnished complete with stainless steel screws.



CATALOG NO.	DESCRIPTION	UOM	ORDER MULTIPLE
EG-EIN3W	3" 90 degree Outside Elbow	EA	1
EG-EIN4W	4" 90 degree Outside Elbow	EA	1

Flex Hose Connection Kit

A flexible hose kit of EasyGuard™ that protects the line set from the condensing unit to the wall. Also provides a quick easy connection between two lengths of channel over or around obstacles. The kit comes with everything needed for a clean professional installation.



CATALOG NO.	DESCRIPTION	UOM	ORDER MULTIPLE
EG-FH3W	3" Flex Hose Connection Kit	EA	1
EG-FH4W	4" Flex Hose Connection Kit	EA	1

EASYGUARD™ FITTINGS

T-Joint

Used for creating a tee connection between three pieces of EasyGuard™ – all covers being the same size. The tee can be combined with the reducing coupling to join SpeediChannel™s of different sizes. Each tee is individually packed, and is furnished complete with stainless steel screws.



EG-TJ4W

CATALOG NO.	DESCRIPTION	UOM	ORDER MULTIPLE
EG-TJ3W	3" T-Joint	EA	1
EG-TJ4W	4" T-Joint	EA	1

Duct End

The duct end is used to terminate a run of EasyGuard™ to a small opening – just large enough for the line set and condensate drain line to pass through. Gives a neat/clean installation.



EG-DE3W

CATALOG NO.	DESCRIPTION	UOM	ORDER MULTIPLE
EG-DE3W	3" Duct End	EA	1
EG-DE4W	4" Duct End	EA	1

Reducer Coupling

Used for joining two pieces of EasyGuard™— each cover being a different size. Each coupling is individually packed, and is furnished complete with stainless steel screws.



EG-TC34W

CATALOG NO.	DESCRIPTION	UOM	ORDER MULTIPLE
EG-TC34W	3" x 4" Reducer Coupling	EA	1

MAINTENANCE CHEMICALS

Accessories	157-158
Additives	166
Coil Cleaners	156-157
Coil Cleaning Aerosols	158
Drain Pan Disinfectant	158
Flushing Products	159
Glycols	158-159
Hoses, Sprayers	160
Ice Machine Products	161
Leak Detectors and Accessories	161-162
Leak Sealants	162-163
Maintenance Chemical Quick Reference Guide	154-155
Odor Neutralizers	163
Pan Treatments/Disinfectants	164
Refrigeration Oils	165
System Cleaners	165
Test Kits	165
Thread Sealants	166
Vacuum Pump Oil	166



Maintenance Chemical Solution Quick Reference Guide

EQUIPMENT TYPE	PRODUCT TYPE			
	TRIPLE-D®	ECO-COIL™	PRO-BROWN™	PRO-BLUE™
Condenser Units	X	X	X	X
(No-Rinse)		X		
Evaporator Units	X	X		
(No-Rinse)	X	X		
Rubber Roof Tops	X			
Fan Blades, Grilles, Etc.	X	X		
Electronic Air Filters	X	X		
Permanent Filters	X	X		
Microchannel Coils	X	X		
Small Condenser Coils	X	X	X	X
Small Evaporator Coils	X	X		
Mini-Splits	X	X		
APPLICATION SOLUTION				
Brightener			X	X
Condensate "Gunk"	X	X	X	X
Degreasing	X	X	X	X
Deodorizer	X	X		
Dirt and Grime	X	X	X	X
Disinfectant	USE SANI C-N-D™ COIL AND DRAIN DISINFECTANT			
Heresite Coated Coils		X		
Oxide Deposits			X	X
Remove Minerals				
CHEMICAL TYPE				
Alkaline	X	X	X	X
Acidic				
DILUTION (PRODUCT: H2O)				
Condensers	1:6	1:3	1:3	1:3
Evaporators	1:10	1:6		
Evaporators (No-Rinse)	1:20	1:6		
PACKAGING AVAILABLE				
19 Ounce Aerosol	TRIPLE-D-AER	ECO-COIL-AER	PRO-BROWN-AER	PRO-BLUE-AER
1 Quart Trigger Sprayer	TRIPLE-D-RTU			
32 Oz. Bottle	TRIPLE-D-32	ECO-COIL-32	PRO-BROWN-32	PRO-BLUE-32
1 Gallon	TRIPLE-D	ECO-COIL	PRO-BROWN	PRO-BLUE
5 Gallon	TRIPLE-D-5	ECO-COIL-5	PRO-BROWN-5	PRO-BLUE-5
55 Gallon Drum	TRIPLE-D-55	ECO-COIL-55	PRO-BROWN-55	PRO-BLUE-55
1 LB Granular	TRIPLE-D-GRAN			
ENVIRONMENTAL				
Biodegradable	X	X	X	X
Meets EPA's Design for the Environment Alternative Program as Green		X		
FOOD COMPLIANCE				
USDA Approved	X	X		X
NSF Registered	X	X		X

EQUIPMENT TYPE	PRODUCT TYPE			
	PRO-GREEN™	PRO-RED PLUS™	PRO-YELLOW™	PRO-KLEEN™
Condenser Units	X	X	X	X
(No-Rinse)	X			
Evaporator Units	X			
(No-Rinse)	X			
Rubber Roof Tops				
Fan Blades, Grilles, Etc.	X			
Electronic Air Filters	X			
Permanent Filters	X			
Microchannel Coils	X			
Small Condenser Coils	X	X	X	X
Small Evaporator Coils	X			
Mini-Splits	X			
APPLICATION SOLUTION				
Brightener		X	X	X
Condensate "Gunk"	X	X	X	X
Degreasing		X	X	X
Deodorizer				
Dirt and Grime	X	X	X	X
Disinfectant	USE SANI C-N-D™ COIL AND DRAIN DISINFECTANT			
Heresite Coated Coils				
Oxide Deposits		X	X	X
Remove Minerals				X
CHEMICAL TYPE				
Alkaline	X	X	X	
Acidic				X
DILUTION (PRODUCT: H2O)				
Condensers	1:3	1:3	1:2	1:3
Evaporators	1:3			
Evaporators (No-Rinse)	1:3			
PACKAGING AVAILABLE				
19 Ounce Aerosol	PRO-GREEN-AER	PRO-RED+AER	PRO-YELLOW-AER	
1 Quart Trigger Sprayer				
32 Oz. Bottle	PRO-GREEN-32	PRO-RED+32	PRO-YELLOW-32	
1 Gallon	PRO-GREEN	PRO-RED+	PRO-YELLOW	PRO-KLEEN
5 Gallon	PRO-GREEN-5	PRO-RED+5	PRO-YELLOW-5	PRO-KLEEN-5
55 Gallon Drum	PRO-GREEN-55	PRO-RED+55	PRO-YELLOW-55	PRO-KLEEN-55
1 LB Granular				
ENVIRONMENTAL				
Biodegradable	X	X	X	X
Meets EPA's Design for the Environment Alternative Program as Green				
FOOD COMPLIANCE				
USDA Approved	X			
NSF Registered	X			

COIL CLEANERS

Triple-D® Universal Coil Cleaner

Triple-D® is the ultimate universal coil cleaner that can be used on condensers, evaporators, microchannels, roof-top units, and mini-split applications. The triple active synergistic highly effective solution is formulated to remove a broad range of soils while degreasing and deodorizing. It is ideal for cleaning most metals including aluminum and copper while extending equipment life and diminishing the potential for refrigerant leaks. Using 75% less than comparable products, it reduces the amount of solution needed to clean. Triple-D® is biodegradable, NSF approved and available in seven different packaging configurations.

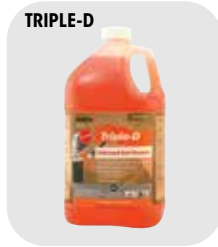

CATALOG NO.	DESCRIPTION	UOM	ORDER MULTIPLE
TRIPLE-D	Triple-D® – 1 gallon concentrate	EA	4
TRIPLE-D-5	Triple-D® – 5 gallon concentrate	EA	1
TRIPLE-D-AER	Triple-D® – 19 oz. Aerosol	EA	12
TRIPLE-D-AER-6	Triple-D® – 19 oz. Aerosol	EA	6
TRIPLE-D-GRAN	Triple-D® – 1 lb. Granular	EA	12
TRIPLE-D-32	Triple-D® – 32 oz. bottle – concentrate	EA	12
TRIPLE-D-RTU	Triple-D® – 1 quart trigger sprayer – pre-diluted	EA	12
TRIPLE-D-55	Triple-D® – 55 gallon drum	EA	1

Eco-Coil™ Environmentally Friendly Coil Cleaner

Eco-Coil™ is an environmentally friendly no rinse non-corrosive cleaner ideal for evaporator and condenser coils, electronic and permanent filters, fan blades, grilles, mini-split and microchannel applications. Eco-coil quickly cleans away dirt, dust, and deposits while deodorizing with no harmful risks to animal, aquatic or plant life. Tested to provide the highest level of performance, Eco-Coil not only reduces the number of products required to clean but also has different water mixture ratios to maximize solution usage. Furthermore, it brightens, biodegradable, NSF approved, and meets the EPA's Design for the Environment Alternative Program as a "green" product.



CATALOG NO.	DESCRIPTION	UOM	ORDER MULTIPLE
ECO-COIL-32	Eco-Coil™ Environmentally Friendly Coil Cleaner – 32 oz. bottle	EA	12
ECO-COIL	Eco-Coil™ Environmentally Friendly Coil Cleaner – 1 gallon container	EA	4
ECO-COIL-55	Eco-Coil™ Environmentally Friendly Coil Cleaner – 55 gallon drum	EA	1
ECO-COIL-AER	Eco-Coil™ – 19 oz. Aerosol	EA	1

Pro-Brown™

Pro-Brown™ is a heavy duty alkaline cleaner that pulls out deeply embedded dirt removing greasy soils and oxidation while brightening and cleaning coils. Ideal for air-cooled condensers and mini-splits thanks to its dual action foaming capabilities. It is biodegradable and NSF approved.



CATALOG NO.	DESCRIPTION	UOM	ORDER MULTIPLE
PRO-BROWN	Pro-Brown™ Foaming Coil Cleaner – 1 gallon container	EA	4
PRO-BROWN-5	Pro-Brown™ Foaming Coil Cleaner – 5 gallon pail	EA	1
PRO-BROWN-AER	Pro-Brown™ – 19 oz. Aerosol	EA	6

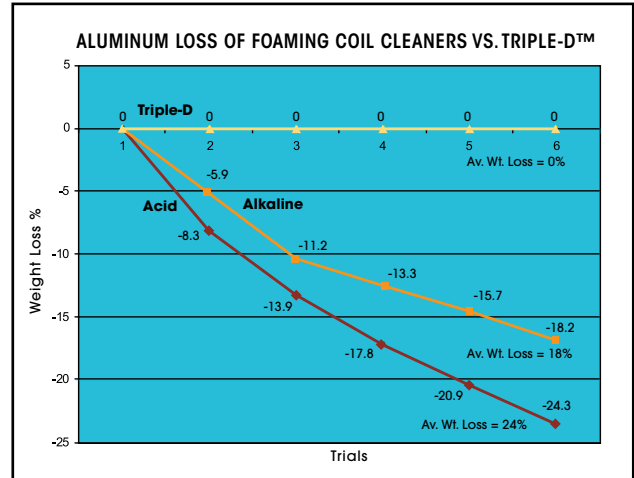

Conventional foaming acid and non-acid coil cleaners attack and chemically react with the aluminum coil components. This reaction is exhibited by a foaming action. The attack/reaction dissolves the aluminum, destroying the heat-transfer ability of the coil and creating the potential for refrigerant leaks.

Pro-Blue™

Pro-Blue™ is a heavy foaming alkaline-based solution designed for condensers and mini-splits that penetrates dirt and grease removing deposits resulting in clean and brightened coils. Pro-Blue is biodegradable, NSF approved, and available in numerous packaging configurations.



CATALOG NO.	DESCRIPTION	UOM	ORDER MULTIPLE
PRO-BLUE-32	Pro-Blue™ Foaming Concentrate (non-acid) – 32 oz. bottle	EA	12
PRO-BLUE	Pro-Blue™ Foaming Concentrate (non-acid) – 1 gallon container	EA	4
PRO-BLUE-5	Pro-Blue™ Foaming Concentrate (non-acid) – 5 gallon pail	EA	1
PRO-BLUE-55	Pro-Blue™ Foaming Concentrate (non-acid) – 55 gallon drum	EA	1
PRO-BLUE-AER	Pro-Blue™ – 19 oz. Aerosol	EA	6

Pro-Green™

Pro-Green™ is a no rinse, mild alkaline coil cleaner that can be used on air-cooled condensers, evaporators, electronic and permanent filters, fan blades, grilles, mini-split and microchannel applications. Pro-Green cleans deposits on coils and rids condensate pans of slime. It is NSF approved for use in federally inspected plants and available in numerous packaging configurations.



CATALOG NO.	DESCRIPTION	UOM	ORDER MULTIPLE
PRO-GREEN-32	Pro-Green™ No Rinse (non-toxic) – 32 oz. bottle	EA	12
PRO-GREEN	Pro-Green™ No Rinse (non-toxic) – 1 gallon container	EA	4
PRO-GREEN-5	Pro-Green™ No Rinse (non-toxic) – 5 gallon pail	EA	1
PRO-GREEN-AER	Pro-Green™ – 19 oz. Aerosol	EA	6

COIL CLEANERS cont'd

Pro-Red Plus™

Pro-Red Plus™ is a fast acting cleaning solution for condensers, microchannels, and mini-splits that foams and lifts away stubborn deposits including tarnish and corrosion. Its non-acid formula is as effective as conventional acid cleaners without the use of hydrofluoric acid. The vigorous foaming action eliminates the need for prolonged soaking, steam cleaning or scrubbing coils and without emitting corrosive fumes or rusting ferrous metals. Pro-Red Plus™ is biodegradable, NSF approved, and available in a number of convenient packaging solutions.



CATALOG NO.	DESCRIPTION	UOM	ORDER MULTIPLE
PRO-RED+32	Pro-Red Plus™ Cleaner and Brightener (non-acid) – 32 oz. bottle	EA	12
PRO-RED+	Pro-Red Plus™ Cleaner and Brightener (non-acid) – 1 gallon container	EA	4
PRO-RED+5	Pro-Red Plus™ Cleaner and Brightener (non-acid) – 5 gallon pail	EA	1
PRO-RED+AER	Pro-Red Plus™ – 19 oz. Aerosol	EA	6

Aerosol Starter Kit

DiversiTech has created a 12 pack of aerosol cans consisting of two each of PRO-BLUE-AER, PRO-RED+-AER, PRO-GREEN-AER, PRO-BROWN-AER, PRO-YELLOW-AER, and ECO-COIL-AER. This starter kit allows wholesalers the opportunity to stock a limited quantity of these new cans.



CATALOG NO.	DESCRIPTION	UOM	ORDER MULTIPLE
AEROSOL-STARTER-KIT	Aerosol Starter Kit – 2 each, 12 cans total	PK	1

Pro-Yellow™

Pro-Yellow™ is a powerful cleaner ideal for condensers, microchannels, and mini-splits that targets large concentrations of dirt and grime. With its heavy foaming alkaline-based solution, debris will be removed from the coil while providing excellent brightening. Pro-Yellow is biodegradable, NSF approved and available in a number of packaging solutions.



CATALOG NO.	DESCRIPTION	UOM	ORDER MULTIPLE
PRO-YELLOW-32	Pro-Yellow™ (non-toxic) – 32 oz. bottle	EA	12
PRO-YELLOW	Pro-Yellow™ (non-toxic) – 1 gallon container	EA	4
PRO-YELLOW-55	Pro-Yellow™ (non-toxic) – 55 gallon drum	EA	1
PRO-YELLOW-AER	Pro-Yellow™ – 19 oz. Aerosol	EA	6

Pro-Kleen™

A unique foaming acid coil cleaner designed to replace hazardous hydrofluoric acid coil cleaners. It contains a synergistic combination of mineral acids, corrosion inhibitors, biodegradable surfactants, penetrants, and degreasers that emulsify, solubilize and neutralize soils leaving a clean, bright, efficient coil surface.



CATALOG NO.	DESCRIPTION	UOM	ORDER MULTIPLE
PRO-KLEEN	Pro-Kleen™ Outdoor Coil Cleaner – 1 gallon container	EA	4

ACCESSORIES

Coil Guard™

Ideally used in coastal areas, where salt air accelerates rust and decay. Highly recommended for use in all geographical areas to prolong the life of a unit. When applied properly, Coil Guard™ dries quickly and immediately resists salt spray, alcohol, acids, and soap solutions. Weather will not blacken it. Coil Guard™ has high dielectric properties and has no effect on heat transfer. Our blue tinted product is used to ensure complete coverage of coating.



CATALOG NO.	DESCRIPTION	UOM	ORDER MULTIPLE
CG-AER	Clear Coil Guard™ – 20 oz. Aerosol	EA	12
CGB-AER	Blue Coil Guard™ – 20 oz. Aerosol	EA	12

Cool-Weld™ Heat Barrier Spray

Spray on thick gel formula that protects surfaces from heat and damage. Odorless, non-toxic gel coats rubber, plastic, and painted surfaces to shield them during welding or soldering.



CATALOG NO.	DESCRIPTION	UOM	ORDER MULTIPLE
COOLWELD-32	Cool-Weld™ Heat Barrier Spray – 32 oz. Container	EA	12

ACCESSORIES cont'd

Pan-Patch™

Pan-Patch™ is a two part epoxy coating with anti-microbial additives designed for HVAC applications. It is a self leveling formula that is ideal in a damp or wet environment. Pan-Patch™ resists corrosion and stops pan leaks without replacing the pan. Light gray in color, one gallon covers about 160 square feet with 10 mil thickness.

PANPATCH-BAG



CATALOG NO.	DESCRIPTION	COVERAGE	UOM	ORDER MULTIPLE
PANPATCH-BAG	Pan-Patch™ Pan Sealant – Bag, pack of 10	8 sq. ft.	EA	10
PANPATCH	Pan-Patch™ Pan Sealant – 1 Gallon	160 sq. ft.	EA	4

COIL CLEANING AEROSOLS

Saf-N-Kleen™ Aerosol Solvent Coil Cleaner

High-solvency formula quickly and easily dissolves dirt, grease, oil or other residue while the blasting nozzle separates the materials from the surface. Non-flammable, non-conductive formula is safe to use on live equipment. Not for use in California.

357-20



CATALOG NO.	DESCRIPTION	UOM	ORDER MULTIPLE
357-20	Saf-N-Kleen™ Solvent Coil Cleaner – 18 oz. Aerosol	EA	12

Foam-Plus™ Aerosol Foaming Coil Cleaner

Heavy-duty foaming detergent coil cleaner in an aerosol can. Non-flammable and water-based with no chlorinated solvents. Blasting foam stream reaches into tight areas for maximum cleaning. The foaming alkaline detergent quickly liquifies dirt, grease, oil or other residue and is completely self-rinsing on condensate producing coils.

358-20



CATALOG NO.	DESCRIPTION	UOM	ORDER MULTIPLE
358-20	Foam-Plus™ Foaming Coil Cleaner – 19 oz.	EA	12

DRAIN PAN DISINFECTANT

Sani C-N-D™ Coil and Drain Pan Disinfectant

Sani C-N-D™ is an EPA registered disinfectant, fungicide, mildewstat and viricide. It is ready-to-use and assures consistent, effective results. Sani C-N-D™ destroys "dirty sock," mildew and other malodors.

SANI-CND



CATALOG NO.	DESCRIPTION	UOM	ORDER MULTIPLE
SANI-CND-32	Sani C-N-D™ Disinfectant – 32 oz. Container	EA	12
SANI-CND	Sani C-N-D™ Disinfectant – 1 Gal. Container	EA	4
SANI-CND-5	Sani C-N-D™ Disinfectant – 5 Gallon Pail	EA	1
SANI-CND-55	Sani C-N-D™ Disinfectant – 55 Gallon Drum	EA	1

Pan-Kote Heavy Duty Drain Pan Patch

A super-durable rubberized coating used to fill-in and patch HVAC drain pans. Seals out rust and corrosion. Stays flexible in variable weather conditions.

641-14



CATALOG NO.	DESCRIPTION	UOM	ORDER MULTIPLE
641-14	Pan-Kote Drain Pan Patch – 14 oz. Aerosol	EA	12

GLYCOLS

DiversiTech produces the most complete line of industrial coolant and heat transfer products in the HVAC/R Industry. Our product line includes ProTek PG propylene glycol products formulated with food-grade corrosion inhibitors and ProTek EG ethylene glycol products for industrial applications. Both product groups are designed to provide freeze and burst protection and are formulated with inhibitors and antifoam agents to provide long-term stability against system corrosion and fouling.

ProTek EG™

An inhibited ethylene glycol based heat transfer fluid designed for use in hydronic, chilled and closed water.

CATALOG NO.	DESCRIPTION	GLYCOL/WATER RATIO	UOM	ORDER MULTIPLE
EG	ProTek EG™ – 1 Gallon Jug	95/5	EA	4
EG-5	ProTek EG™ – 5 Gallon Pail	95/5	EA	1
EG-55	ProTek EG™ – 55 Gallon Drum	95/5	EA	1

EG



GLYCOLS cont'd

ProTek™ Closed Loop Heat Transfer Fluid

ProTek™ for closed loop water recirculation systems is a blue liquid. Available in three concentrations: original ProTek-100™, ProTek-50™, and ProTek-Plus™. Each concentration may be further diluted to alter freeze and burst temperatures. Refer to the technical data sheet for specific information.



CATALOG NO.	DESCRIPTION	GLYCOL/WATER RATIO	UOM	ORDER MULTIPLE
PG-50	ProTek-50™ – 1 Gallon Jug	35/65	EA	4
PG-50-5	ProTek-50™ – 5 Gallon Pail	35/65	EA	1
PG-50-55	ProTek-50™ – 55 Gallon Drum	35/65	EA	1

ProTek PG Plus™

ProTek PG PLUS™ is an inhibited propylene glycol based industrial heat transfer fluid and anti freeze that contains food grade corrosion inhibitors. It is suitable for use in potable water systems. ProTek PG PLUS™ is designed to provide freeze and burst protection, excellent thermal conductance, protection against corrosion and fouling and long term stability in closed recirculating water loops. ProTek PG PLUS™ must be mixed with water to provide freeze and burst protection. Freeze points and burst points are controlled by the propylene glycol to water ratio.



CATALOG NO.	DESCRIPTION	GLYCOL/WATER RATIO	UOM	ORDER MULTIPLE
PG-PLUS	ProTek-Plus™ – 1 Gallon Jug	95/5	EA	4
PG-PLUS-5	ProTek-Plus™ – 5 Gallon Pail	95/5	EA	1
PG-PLUS-55	ProTek-Plus™ – 55 Gallon Drum	95/5	EA	1

ProTek PG 100™

ProTek 100™ is an inhibited propylene glycol based industrial heat transfer fluid and antifreeze that contains food grade corrosion inhibitors. It is suitable for use in potable water systems. ProTek 100™ is designed to provide freeze and burst protection, excellent thermal conductance, protection against corrosion and fouling and long term stability in closed recirculating water loops. ProTek 100™ provides burst protection to 100°F. Freeze points and burst points are controlled by the propylene glycol to water ratio.



CATALOG NO.	DESCRIPTION	GLYCOL/WATER RATIO	UOM	ORDER MULTIPLE
PG-100	ProTek-100™ – 1 Gallon Jug	70/30	EA	4
PG-100-5	ProTek-100™ – 5 Gallon Pail	70/30	EA	1
PG-100-55	ProTek-100™ – 55 Gallon Drum	70/30	EA	1

ProTek BG™ for Cast Iron Water Boilers

A red liquid boiler grade product formulated specifically with corrosion inhibitors necessary for use in water boilers.



CATALOG NO.	DESCRIPTION	GLYCOL/WATER RATIO	UOM	ORDER MULTIPLE
PG-BG	ProTek-BG™ – 1 Gallon Jug	70/30	EA	4
PG-BG-5	ProTek-BG™ – 5 Gallon Pail	70/30	EA	1
PG-BG-55	ProTek-BG™ – 55 Gallon Drum	70/30	EA	1

FLUSHING PRODUCTS

Pro-Flush® HVAC Flushing Solvent

A flushing solvent for A/C and refrigeration systems formulated for R410A retrofits, refrigerant conversions and compressor burnouts. Compatible with all refrigerants and compressor oils. All solvents in Pro-Flush® conform to EPA SNAP standards: low toxicity and residue free. Available as a kit or in an 8 or 16 oz. solvent refill. The kit makes servicing quick, easy, and safe, as well as assuring you get to the job site with all necessary hardware in hand for 1 stop servicing. The kit includes: 8 oz. container of Pro-Flush® solvent, refillable Pro-Flush® injector tool pressure tank, pressure relief valve for added safety, large rubber adapter that flushes up to 1-1/4" line sets, service hose.



CATALOG NO.	DESCRIPTION	UOM	ORDER MULTIPLE
PF-KIT	Pro-Flush® Kit – injector, 8 oz. refill, nozzle adapter and hose	EA	3
PF-08	Pro-Flush® HVAC Flushing Solvent – 8 oz. Refill	EA	6
PF-16	Pro-Flush® HVAC Flushing Solvent – 16 oz. Refill	EA	6
PF-ADAPTER	Pro-Flush® Line Set Adapter	EA	1
PF-IGUN	Replacement Injector Tool	EA	1
PF-IHOSE	2' Replacement Hose	EA	1

Super Change™

Super Change eliminates oil change outs replacing R22 line set conversion flushes. Ideal for dry charged units, retrofits, and drop-in refrigerants, Super Change maximizes oil return and heat transfer including POE charged compressors. Reusable hose (20122) sold separately. Also available in flexible injectable hose (991).

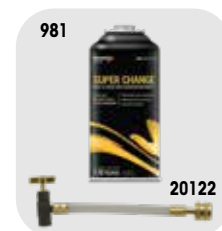

CATALOG NO.	DESCRIPTION	UOM	ORDER MULTIPLE
981	Super Change™ - Up to 6 Tons	EA	6
20122	Reusable Charging Hose for Super Change™	EA	1
991	Super Change™ Inject	EA	4

HOSES, SPRAYERS

Power Sprayer

DiversiTech's Power Sprayer makes coil cleaning easier and faster! Designed as a backpack sprayer, it holds up to 4 gallons of coil cleaning solution. The battery powered unit will spray continuously for 10 hours on a single charge. Included are three different nozzles to give you the right spray for any situation. It also features: padded backpack straps for a comfortable fit, plug-in charger for fast recharging, a convenient center mount handle, an extra long spray wand with curved tip for accurate application, and a large on/off valve which can lock in position for easier spraying of big jobs. The large tank opening also makes it easy to add coil cleaner and mix to the correct ratio. The Power Sprayer is compatible with all DiversiTech coil cleaners.



CATALOG NO.	DESCRIPTION	UOM	ORDER MULTIPLE
PS-1	Battery powered/rechargeable backpack sprayer for coil cleaning	EA	1

Dial-a-Mix Sprayer

Save time and money by dialing in the exact mix ratio to properly clean the coil. This sprayer features 5 mix ratios, a 1/2 gallon capacity bottle and a quick disconnect for fast and easy rinsing.



CATALOG NO.	DESCRIPTION	UOM	ORDER MULTIPLE
540-GUN	Dial-a-Mix Sprayer	EA	6

Garden Hose

High quality product priced for high volume sales. Soft-Flex formulation makes the 5 ply Hose easy to handle. Withstands 500 psi water pressure. Heavy duty solid brass couplings and collar. Full Lifetime Guarantee!

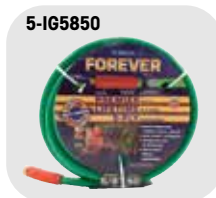

CATALOG NO.	DESCRIPTION	UOM	ORDER MULTIPLE
5-IG5850	Green Flexon 5-Ply Forever Garden Hose	EA	5

All Purpose Sprayers

Lightweight, versatile gallon size bottle has a 28" flexible hose and easy-to-carry handle. Best for big jobs in hard-to-reach places. Adjustable nozzle will atomize any low viscosity liquid. Adjusts from a mist to a 12' jet stream or anything in between. One pint container has a measured ounce guide. Ideal for water treatment chemicals.



CATALOG NO.	DESCRIPTION	UOM	ORDER MULTIPLE
BS-32	Quart Size Sprayer	EA	12

Compression Sprayers

Acid impervious poly design with a 36" (91cm) reinforced hose, shut-off with lock-on feature for continuous spraying, a 2-piece nozzle that's detachable for easy clean up and fits directly to the shut-off or extension wand. The Hand-Held Sprayer has a 48 oz. (1.4 l) capacity, perfect for small areas. All sprayers have a full 5 year warranty.



CATALOG NO.	DESCRIPTION	UOM	ORDER MULTIPLE
1002	Hand Held Sprayer	EA	1
2601	1 Gallon Wand Sprayer	EA	1
2602	2 Gallon Wand Sprayer	EA	1
2603	3 Gallon Wand Sprayer	EA	1

Hot Water Hose

High burst strength. 500 PSI. Withstands hot water up to 160°F. EPDM tube. Heavy duty solid brass couplings.

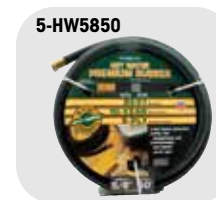

CATALOG NO.	DESCRIPTION	UOM	ORDER MULTIPLE
5-HW5850	5/8" x 50' Hot Water Hose	EA	5

Pistol Grips & Water Nozzle

Pistol Grip – 540-572 Insulated:
For spraying hot or cold water. Heavy-duty, self adjusting "duck" packing for lifetime proof seal.
Water Nozzle – 540-573 Un-insulated:
Heavy-duty and holds open clip for continuous spraying. Self-adjusting "duck" for leak proof seal.



CATALOG NO.	DESCRIPTION	UOM	ORDER MULTIPLE
540-572	Insulated Pistol Grip	EA	12
540-573	Uninsulated Water Nozzle	EA	12

ICE MACHINE PRODUCTS

Super-Kool™ Nickel-Safe and Metal-Safe Ice Machine Cleaner

An economical, fast-acting, non-foaming acid sequestrant formula that quickly removes soil and mineral buildup. This safe, highly-concentrated, inhibited formula will not attack nickel or other metal components. USDA AUTHORIZED



CATALOG NO.	DESCRIPTION	UOM	ORDER MULTIPLE
SUPER-KOOL-16	Super-Kool™ Ice Machine Cleaner – 16 oz. Bottle	EA	12
SUPER-KOOL	Super-Kool™ Ice Machine Cleaner – 1 Gallon Container	EA	4

LEAK DETECTORS AND ACCESSORIES

Bubble-N-Trouble™ Freeze Protected Spray-On Leak Detector

Non-corrosive, non-toxic, and biodegradable. Does not attack metal or interfere with brazing or soldering. Spray-on application allows easy access for hard to reach places. Tacking agent holds solution on test surface making Bubble-N-Trouble™ very economical. USDA AUTHORIZED



CATALOG NO.	DESCRIPTION	UOM	ORDER MULTIPLE
BNT-32	Bubble-N-Trouble™ Freeze Protected Leak Detector – 32 oz. Spray	EA	12
BNT-1	Bubble-N-Trouble™ Freeze Protected Leak Detector – 1 Gallon Container	EA	4

Pro-Bubble™ Leak Detector

Easy-to-use, high-bubbling, viscoelastic blue leak detector. New improved formula.



CATALOG NO.	DESCRIPTION	UOM	ORDER MULTIPLE
PRO-BUBBLE-32	Pro-Bubble™ Leak Detector – 32 oz. Bottle with Spray Top	EA	12

Radiant Leak Finder™

Radiant color and viscous clinging formula exposes the smallest leaks. Freeze-protected – remains effective down to 0° F.



CATALOG NO.	DESCRIPTION	UOM	ORDER MULTIPLE
RLF-8	Radiant Leak Finder™ – 8 oz. Container	EA	12

Flash™ Detect UV Dye

Flash™ Detect Inject (990) is an integrated UV dye solution that injects like Flex Inject® Sealant without the use of tools or manifold gauges. Flash™ Detect (980) will not react with moisture and travels with the speed of the refrigerant once installed finding leaks within minutes. Using a patented misting orifice. Flash™ Detect Inject uses the refrigerant as the propellant ensuring a no-mess injection every time (20122 reusable hose sold separately for 980).



CATALOG NO.	DESCRIPTION	UOM	ORDER MULTIPLE
980	Flash™ Detect Universal UV Dye - Up to 5 Tons	EA	12
20122	Reusable Hose, Clear for 980	EA	1
990	Flash™ Detect Inject - Up to 6 Tons	EA	6

Flash™ Detect UV Leak Detection Kit

Flash™ Detect UV leak detection kit include 3 cans of Flash dye, a reusable clear hose, heavy-duty storage case, and choice of UV light.



CATALOG NO.	DESCRIPTION	UOM	ORDER MULTIPLE
98084KIT	Flash™ Detect with 3 cans, hose, and SEEKERmini™ Worklight	EA	1
98087KIT	Flash™ Detect with 3 cans, hose, and SEEKERmini™ Worklight	EA	1

SEEKERmini™

High powered UV light with 3 AAA batteries included with no UV enhancing glasses required.



CATALOG NO.	DESCRIPTION	UOM	ORDER MULTIPLE
84DCPLUS	SEEKERmini™ UV LED Worklight	EA	1

LEAK DETECTORS AND ACCESSORIES cont'd

SEEKERmax™

High powered UV light with rechargeable 2200 mAh lithium-ion battery with no UV enhancing glasses required.



CATALOG NO.	DESCRIPTION	UOM	ORDER MULTIPLE
87DCPLUS	SEEKERmax™ UV LED Worklight	EA	1

UV Pocket Light

UV Pocket Light with 3 AAA batteries included. A great light to pair with 995 Flex Inject® Sealant and 990 Flash™ Detect Inject.



CATALOG NO.	DESCRIPTION	UOM	ORDER MULTIPLE
89DC	UV Pocket Light	EA	12

Patriot Pocket Worklight

A three light integrated rechargeable system that includes a red top light (30 lumens), 250 lumen front light, and a 390-400nm wavelength UV light. Patriot charger sold separately (111110A).



CATALOG NO.	DESCRIPTION	UOM	ORDER MULTIPLE
111110	Patriot Worklight	EA	6
111110A	Patriot Worklight Charger	EA	6

LEAK SEALANTS

Flex Inject® Sealant Advanced & Total

Flex Inject® Sealant Advanced is the fastest, most effective proven way to permanently seal and prevent minor air conditioning and refrigeration (AC/R) leaks. With no tools or gauges required, the Flex Inject® Sealant Advanced works by travelling through the system with the oil and refrigerant fixing leaks immediately (up to 300 microns). Flex Inject® Sealant Advanced works with all compressors, heat pumps, condensers, and other system components and it will not plug up manifold gauges, metering devices, thermostatic expansion valves (TXVs), pistons or cause cap tube blockages. It meets the ASHRAE ARI 700 refrigerant standard and is compatible with any refrigerant including R-410A with no pump downs or recoveries required. Flex Inject® Sealant Advanced is suitable for use in aluminum and copper coils and is microchannel friendly. Flex Inject® Sealant Total has all the benefits of Advanced but includes UV dye.



CATALOG NO.	DESCRIPTION	UOM	ORDER MULTIPLE
985	Flex Inject® Sealant Advanced	EA	6
995	Flex Inject® Sealant Total	EA	6
999KIT	Flex Inject® and Flash™ Detect Merchandiser Kit Four each of 985, 990, 995 (Case of 12)	EA	1

Super Seal™ Sealant Advanced

Super Seal™ Sealant Advanced includes a stop leak sealant and Dry R™. Provides for a fast install with no pump down or recovery even for R410A. Compatible with all oils and refrigerants. Hose included.



CATALOG NO.	DESCRIPTION	UOM	ORDER MULTIPLE
947KIT	Super Seal™ Sealant Advanced - Up to 1.5 Tons	EA	12
944KIT	Super Seal™ Sealant Advanced - 1.5 to 5 Tons	EA	12
948KIT	Super Seal™ Sealant Advanced - 5+ Tons	EA	1

Super Seal™ Sealant Total

Super Seal™ Sealant Total includes a stop leak sealant, Dry R™, and Flash™ with all the benefits of Super Seal™ Sealant Advanced plus UV dye. Hose included.

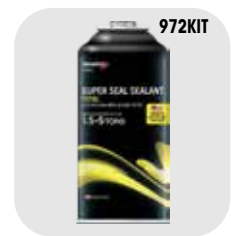

CATALOG NO.	DESCRIPTION	UOM	ORDER MULTIPLE
971KIT	Super Seal™ Sealant Total - Up to 1.5 Tons	EA	12
972KIT	Super Seal™ Sealant Total - 1.5 Tons to 5 Tons	EA	12

Seal-N-Go® Self-Sealing Refrigerant

Seal-N-Go® is an excellent solution for taking R410A refrigerant on job sites and includes Super Seal™ Sealant Advanced. It allows technicians to fill and stop and prevent leaks simultaneously. With a reusable charging hose (sold separately), the 25.7 ounce lightweight cannister is great for topping off multiple systems and perfect for mini-split installs. Reusable charging hose (20133) sold separately.



CATALOG NO.	DESCRIPTION	UOM	ORDER MULTIPLE
9410SSR	Seal-N-Go® 25.7 R410 Refrigerant plus Super Seal™ Sealant Advanced	EA	6
20133	Reusable Charging Hose with Gauge	EA	1

LEAK SEALANTS cont'd

Super Seal™ Sealant Sure Shot

Super Seal™ Sealant Sure Shot includes a stop leak sealant and Eco Boost. Hose and cartridge included.



CATALOG NO.	DESCRIPTION	UOM	ORDER MULTIPLE
983KIT	Super Seal™ Sealant Sure Shot - Up to 6 Tons	EA	12
984	Super Seal™ Sealant Sure Shot - Up to 6 Tons Replacement Cartridge	EA	12

ODOR NEUTRALIZERS

Duct-Fresh™ Gel

A non-toxic, super-effective odor neutralizer for HVAC ducts, proficient at destroying stubborn odors including pet, smoke, and musty smells in residential, industrial and commercial applications. Effective for up to 6 months.



CATALOG NO.	DESCRIPTION	UOM	ORDER MULTIPLE
DUCT-FRESH-8	Duct-Fresh™ Gel – 8 oz.	EA	12
DUCT-FRESH-16	Duct-Fresh™ Gel – 16 oz.	EA	8

Duct-Fresh™ Spray

A non-toxic, instantaneous, super-effective odor neutralizer for HVAC ducts. Destroys stubborn pet odors, smoke, and musty smells in residential, industrial and commercial applications. Great for spot-treating malodor problem areas.



CATALOG NO.	DESCRIPTION	UOM	ORDER MULTIPLE
DUCT-FRESH-32	Duct-Fresh™ Spray – 1 Quart	EA	12

The Purifier™

The Purifier™ is an electric device that removes stubborn odors like tobacco smoke. It eliminates mold, mildew and bacteria from HVAC systems. The Purifier™ completes most jobs in just 20 minutes. Includes programmable timer with LCD display.



CATALOG NO.	DESCRIPTION	UOM	ORDER MULTIPLE
170AIR	The Purifier™ Fresh Air Ozone Machine	EA	1
170AIRFAN	Replacement Fan	EA	1
170AIRPCB	Replacement Circuit Board	EA	1
UVEC-07G	12V Charger for Cigarette Lighter	EA	1
410212	Replacement UV Bulb	EA	1

Odor-Aid™

Disinfects and deodorizes with an easy pump spray. Eliminates bacteria, germs and microorganisms that cause offensive odors.



CATALOG NO.	DESCRIPTION	UOM	ORDER MULTIPLE
171AIR	Odor-Aid™ – 7 oz. Bottle with Spray Top	EA	12

PAN TREATMENTS/DISINFECTANTS

Flow Plus® Condensate Pan Treatment

A unique polymer formula that maintains condensate flow and prevents drain pan overflow. 100% active. No residue—no waste—nonclogging. Effective, long-term condensate activated release. Environmentally safe, non-toxic, and non-corrosive. Also economical with sizes to meet all tonnage requirements.

CATALOG NO.	EQUIPMENT TONNAGE
FLOW-PLUS-25	1/2 to 3 tons
FLOW-PLUS-200	1/2 to 3 tons
FLOW-PLUS-6	3 to 5 tons
FLOW-PLUS-10	5 to 20 tons
FLOW-PLUS-125	20 to 50 tons

CATALOG NO.	DESCRIPTION	UOM	ORDER MULTIPLE
FLOW-PLUS-25	Flow-Plus® Condensate Pan Treatment – 25 Tabs/Jar	EA	12
FLOW-PLUS-200	Flow-Plus® Condensate Pan Treatment – 200 Tabs/Jar	EA	4
FLOW-PLUS-6	Flow-Plus® Condensate Pan Treatment – 6 - 1 oz. Blocks	EA	12
FLOW-PLUS-10	Flow-Plus® Condensate Pan Treatment – 10 oz. Tubs	EA	18
FLOW-PLUS-125	Flow-Plus® Condensate Pan Treatment – 1.25 lb. Tubs	EA	8

FLOW-PLUS-200



Pro-Treat® 350 Condensate Drain Pan Treatment

Place a Pro-Treat® 350 tablet in a condensate drain pan and condensed moisture will slowly dissolve the tablet, thinly coating the pan surface to give prolonged cleaning action on sludge. Dosage: one or two tablets are recommended in each pan per month. For industrial use only!

PROTREAT-350



CATALOG NO.	DESCRIPTION	UOM	ORDER MULTIPLE
PROTREAT-350	Pro-Treat® 350 Condensate Pan Treatment – EA 100 Tablets per Jar	EA	24

Pro-Treat® 152 King-Size Premium Condensate Drain Pan Treatment

Economical, safe, effective king-size tablets last three times longer. Safe, non-corrosive, odor-free and 100% soluble. Computer room approved. Keeps drain pans and condensate lines clean and free flowing. Dosage: 1 tablet per 3 tons per 3 months.

PROTREAT-152



CATALOG NO.	DESCRIPTION	UOM	ORDER MULTIPLE
PROTREAT-152	Pro-Treat® 152 King-Size Premium Drain Pan Treatment – 12 Tablets/Jar	EA	6

Pro-Treat®-151 Premium Condensate Drain Pan Treatment

Pro-Treat®-151 premium tablets penetrate and help remove sludge that can plug drain pans and drain lines and foul humidifier pans. Kills odors associated with slime and sludge, minimizing maintenance problems from overflow and water damage caused by fouled pans, plugged traps, or drain lines. Tablets are 100% soluble, easy-to-use, and do not form any deposits in the pan or drain line. Approved for computer rooms. Dosage: 1 tablet per 3 tons each month. PRO-TREAT-151 is EPA registered.

PROTREAT-151 EPA Registered



CATALOG NO.	DESCRIPTION	UOM	ORDER MULTIPLE
PROTREAT-151	Pro-Treat®-151 Premium Drain Pan Treatment – 100 Tablets/Jar	EA	12

Pro-Treat® 161 Condensate Drain Pan Treatment

Controls odors and eliminates condensate drain pan overflows and the resulting water damage. 100% soluble, easy-to-use, non-corrosive, and non-toxic. Use regularly to assure season-long, trouble-free condensate drain pan performance. Approved for computer rooms. Dosage: 2 tablets per 3 tons each month.

PROTREAT-161



CATALOG NO.	DESCRIPTION	UOM	ORDER MULTIPLE
PROTREAT-161	Pro-Treat® 161 Drain Pan Treatment – 100 Tablets/Jar	EA	12

Pro-Treat® 217 Economy Condensate Drain Pan Treatment

Economical with 200 tablets per jar. Safe, non corrosive, odor free and 100% soluble. Approved for computer rooms. Convenient, easy to use tablet form provides prolonged cleaning action. Dosage 3 tablets per 3 tons per month.

PROTREAT-217



CATALOG NO.	DESCRIPTION	UOM	ORDER MULTIPLE
PROTREAT-217	Pro-Treat® 217 Economy Drain Pan Treatment – 200 Tablets/Jar	EA	12

Pro-Treat® 200 Economy Condensate Drain Pan Treatment

Economical with 200 tablets per jar. Safe, non-corrosive, odor-free and 100% soluble. Approved for computer rooms. Convenient, easy-to-use tablet form provides prolonged cleaning action. Dosage: 3 tablets per 3 tons per month.

PROTREAT-200



CATALOG NO.	DESCRIPTION	UOM	ORDER MULTIPLE
PROTREAT-200	Pro-Treat® 200 Economy Drain Pan Treatment – 200 Tablets/Jar	EA	12

Pro-Treat® Pan Strips

Pro-Treat® Pan Strips kill odor causing bacteria and last up to 6 months. Use in the primary drain pan of cooling units such as air conditioners and refrigerators. Pro-Treat® Pan Strips control foul-smelling odors caused by mildew, fungi, bacteria, algae, and slime. For use in hotels, schools, colleges, hospitals, nursing homes, airports, and many other locations.



CATALOG NO.	DESCRIPTION	STRIPS/PACK	UOM	ORDER MULTIPLE
PS-075	Pro-Treat® Pan Strips – for up to 3/4 Ton	10	EA	12
PS-01	Pro-Treat® Pan Strips – for 1 to 2 Ton	10	EA	12
PS-03	Pro-Treat® Pan Strips – for 3 to 5 Ton	6	EA	24
PS-07	Pro-Treat® Pan Strips – for 7 to 12 Ton	2	EA	24
PS-20	Pro-Treat® Pan Strips – for 20 to 25 Ton	1	EA	24
PS-40	Pro-Treat® Pan Strips – for 40 to 50 Ton	1	EA	12

EPA Registration #6836-254-69966

REFRIGERATION OILS

Pro-Lube™ Mineral Oil

Specialty Chemical mineral oil (by Calumet) is a superior mineral naphthenic refrigeration oil designed to meet the operating requirements of modern residential and commercial air conditioning and refrigeration compressors. These oils have a low pour point, low wax floc temperature and are chemically and thermally stable in the presence of refrigerants. OEM approved by Copeland, Carlyle, Trane, and other major compressor manufacturers. Always follow compressor manufacturer's oil viscosity recommendations. Mineral oil is specially recommended for lubrication of compressors containing ammonia, R-11, 12, 13, 22, 113, 114, 123, 500 and 502 refrigerants in residential, industrial and commercial service. **DO NOT USE WITH HFC REFRIGERANTS SUCH AS R-134A.**



3WF-01

CATALOG NO.	DESCRIPTION	UOM	ORDER MULTIPLE
3WF-01	SUS150 ISO32 Pro-Lube™ Mineral Oil – 1 Gallon Jug	EA	4
4WF-01	SUS300 ISO68 Pro-Lube™ Mineral Oil – 1 Gallon Jug	EA	4

Pro-Lube-POE™ Polyolester

Specialty Chemical POE is custom formulated for use in refrigeration compressors. This series contains no ozone depleting substances and is compatible with new HFC refrigerants as well as existing CFC and HCFC refrigerants. POE is also compatible with traditional mineral oil lubricants.



POE32-32

CATALOG NO.	DESCRIPTION	UOM	ORDER MULTIPLE
POE32-32	SUS150 ISO32 Pro-Lube-POE™ Polyolester – 1 Quart Can	EA	12
POE32-01	SUS150 ISO32 Pro-Lube-POE™ Polyolester – 1 Gallon Can	EA	6
POE68-32	SUS300 ISO68 Pro-Lube-POE™ Polyolester – 1 Quart Can	EA	12
POE68-01	SUS300 ISO68 Pro-Lube-POE™ Polyolester – 1 Gallon Can	EA	6
POE100-32	SUS500 ISO100 Pro-Lube-POE™ Polyolester – 1 Quart Can	EA	12
POE100-01	SUS500 ISO100 Pro-Lube-POE™ Polyolester – 1 Gallon Can	EA	6

SYSTEM CLEANERS

D'Scale™ Acid Scale Remover for Cooling Towers

D'Scale™ will not create corrosive acidic foam. D'Scale™ has pH indicating dye. The color changes to yellow when acid has been consumed. Each gallon dissolves 3 pounds of scale.



D-SCALE

CATALOG NO.	DESCRIPTION	UOM	ORDER MULTIPLE
D-SCALE	D'Scale™ Acid Scale Remover – 1 Gallon Container	EA	4

TEST KITS

Acid Test Kit™

Detects acid in refrigeration oil. Convenient, one-step test means no chemicals to mix. Easy to evaluate. Color change indicates acidity; color intensity reveals the amount of acid present in the oil sample.



ATK-1

ATK-1P

CATALOG NO.	DESCRIPTION	UOM	ORDER MULTIPLE
ATK-4	Acid Test Kit™, pack of 4	EA	4
ATK-1	Acid Test Kit™	EA	1
ATK-1P	Acid Test Kit™ for POE Oil	EA	1

THREAD SEALANTS

PRO-TITE™ Resin Based Thread Sealant

Resin based thread sealant that adheres to internal surfaces, fills voids while forming a flexible fluid tight seal. Specifically formulated for use on metals and plastics subject to extreme vibration. Serviceable at temperatures from 100°F (73°C) to 400°F (204°C) and from full vacuum to 10,000 PSI. Pro-Tite™ is impervious to most chemicals including refrigerants, petroleum products, gases, steam, etc. Alcohol based.



CATALOG NO.	DESCRIPTION	UOM	ORDER MULTIPLE
CLL-1	Pro-Tite™ Thread Sealant – 1-1/3 oz. Squeeze Tube	EA	12
CLL-4	Pro-Tite™ Thread Sealant – 4 oz. Brush Top	EA	12

VACUUM PUMP OIL

Pro-Lube-VAC™ Vacuum Pump Oil

VP-68 Premium Vacuum Pump Oil is now based on a highly refined paraffinic based stock. This new improved formulation is lighter in color and provides better viscosity and oxidation stability than the previous formulation. VP-68 provides excellent cold start performance; formulated to meet minimum moisture content specifications.



CATALOG NO.	DESCRIPTION	UOM	ORDER MULTIPLE
VP68-32	Pro-Lube-VAC™ Vacuum Pump Oil – 1 Quart Jug	EA	12
VP68-01	Pro-Lube-VAC™ Vacuum Pump Oil – 1 Gallon Jug	EA	4
VP68-05	Pro-Lube-VAC™ Vacuum Pump Oil – 5 Gallon Pail	EA	1

ADDITIVES

Acid Eliminator

Keeps acid away; compatible with all refrigerants and oils. Chemically neutralizes and prevents acids that are formed in air conditioning and refrigeration systems due to refrigerant and refrigeration oil break-down, moisture, and compressor burnout. Easy-to-use, no complicated charts. Works fast, circulates quickly, and leaves no solids or solid residuals. Will not harm system components. Can prevent system breakdown.



CATALOG NO.	DESCRIPTION	UOM	ORDER MULTIPLE
ACID-ELIM	Acid Eliminator – 4 oz. Plastic Bottle	EA	12

Dry R™

DRY R™ enhances the function of driers and metering devices by removing non-condensables, eliminating ice crystals, and breaking down blockages by removing scale and sludge on moving parts such as TXVs.



CATALOG NO.	DESCRIPTION	UOM	ORDER MULTIPLE
973KIT	Dry R™ Moisture Eliminator - Up to 5 tons	EA	12

Pro-Thaw™ Liquid Dryer for Refrigerants

Chemically dries all refrigerants (R-12, R-22, R-134a, etc.), methyl chloride and methylene chloride. Frees up systems frozen due to moisture contamination in 5 minutes and prevents refreezing. Does not contain any dissolved solids, leaves no residue and works with or without solid dryers.



CATALOG NO.	DESCRIPTION	UOM	ORDER MULTIPLE
PRO-THAW-1	Pro-Thaw™ – 1 oz. Plastic Bottle	EA	24
PRO-THAW	Pro-Thaw™ – 4 oz. Plastic Bottle	EA	12

Boost Juice® & Boost Juice® Inject

Boost Juice® is an HVAC/R system performance improvement additive that lowers energy costs by reducing the amperage draw up to 22% (testing average of 13%) on a system when running.



CATALOG NO.	DESCRIPTION	UOM	ORDER MULTIPLE
992	Boost Juice® Inject - Up to 6 Tons	EA	4
993KIT	Boost Juice® Kit - Up to 6 Tons	EA	6

INLINE COMPONENTS

Access Fittings	172
Brass Fittings.....	174-176
Copper Fittings	169-171
Cushion Clamps	176
Driers, Sight Glasses.....	177-178
Line Piercing Valves and Tools	173
Refrigerant Charging.....	178
Refrigerant Tubing.....	179-182
Refrigerant Labels.....	182
Refrigerant Recovery Products.....	183
Sentry™ Refrigerant Locking Caps	168
Tubing Insulation	183-184



SENTRY™ REFRIGERANT LOCKING CAPS

Sentry™ Refrigerant Locking Caps - R-410, Red, 1/4"

The Sentry™ Refrigerant Locking Caps are quick and easy way to comply with the IRC and IMC codes requirement that all outdoor access ports on A/C and refrigerant equipment have to be tamper resistant. This cap is anodized in red color for easy identification of R-410 refrigerant. It is designed for 1/4" access ports. An O-ring seal is also pre-installed to prevent leaks.

RSC-RED-02



CATALOG NO.	DESCRIPTION	UOM	ORDER MULTIPLE
RSC-RED-02	Sentry™ Refrigerant Locking Caps - 1/4", Red, 2 pcs Pack	PK	1
RSC-RED-04K	Sentry™ Refrigerant Locking Caps - 1/4", Red, 4 pcs Pack w/1 Universal Key	PK	1
RSC-RED-10	Sentry™ Refrigerant Locking Caps - 1/4", Red, 10 pcs Pack	PK	1
RSC-RED-50K	Sentry™ Refrigerant Locking Caps - 1/4", Red, 50 pcs Pack w/2 Universal Keys	PK	1
RSC-RED-500	Sentry™ Refrigerant Locking Caps - 1/4", Red, 50 pcs Pack w/5 Driver Bits	PK	1

Sentry™ Refrigerant Locking Caps - R-410, Red, 5/16"

The Sentry™ Refrigerant Locking Caps are quick and easy way to comply with the IRC and IMC codes requirement that all outdoor access ports on A/C and refrigerant equipment have to be tamper resistant. This cap is anodized in red color for easy identification of R-410 refrigerant. It is designed for 5/16" access ports typically used on mini-splits and European styles of A/C systems. An O-ring seal is also pre-installed to prevent leaks.

RSC-RED-02-E



CATALOG NO.	DESCRIPTION	UOM	ORDER MULTIPLE
RSC-RED-02-E	Sentry™ Refrigerant Locking Caps - 5/16", Red, 2 pcs Pack w/ Universal Key	PK	1
RSC-RED-04K-E	Sentry™ Refrigerant Locking Caps - 5/16", Red, 4 pcs Pack w/1 Universal Key	PK	1
RSC-RED-10-E	Sentry™ Refrigerant Locking Caps - 5/16", Red, 10 pcs Pack	PK	1
RSC-RED-50K-E	Sentry™ Refrigerant Locking Caps - 5/16", Red, 50 pcs Pack w/2 Universal Keys	PK	1

Sentry™ Universal Key for Refrigerant Locking Caps

This Universal Key is not only for DiversiTech's Sentry™ Refrigerant Locking Caps. It has three different keys that is fit to lock and unlock most of the refrigerant locking caps in the market. It is compact and easy to carry. This is the key contractors needed to get the job done!

RSC-TOOL



CATALOG NO.	DESCRIPTION	UOM	ORDER MULTIPLE
RSC-TOOL	Universal Key for Refrigerant Locking Caps	EA	1

Sentry™ Refrigerant Locking Caps - R-22, Green, 1/4"

The Sentry™ Refrigerant Locking Caps are quick and easy way to comply with the IRC and IMC codes requirement that all outdoor access ports on A/C and refrigerant equipment have to be tamper resistant. This cap is anodized in green color for easy identification of R-22 refrigerant. It is designed 1/4" access ports. An O-ring seal is also pre-installed to prevent leaks.

RSC-GRN-02



CATALOG NO.	DESCRIPTION	UOM	ORDER MULTIPLE
RSC-GRN-02	Sentry™ Refrigerant Locking Caps - 1/4", Green, 2 pcs Pack	PK	1
RSC-GRN-04K	Sentry™ Refrigerant Locking Caps - 1/4", Green, 4 pcs Pack w/1 Universal Key	PK	1
RSC-GRN-10	Sentry™ Refrigerant Locking Caps - 1/4", Green, 10 pcs Pack	PK	1
RSC-GRN-50K	Sentry™ Refrigerant Locking Caps - 1/4", Green, 50 pcs Pack w/2 Universal Keys	PK	1

Sentry™ Refrigerant Locking Caps - Universal, Silver, 1/4"

The Sentry™ Refrigerant Locking Caps are quick and easy way to comply with the IRC and IMC codes requirement that all outdoor access ports on A/C and refrigerant equipment have to be tamper resistant. This cap is anodized in silver color and could be used on different types of refrigerants. It is designed for 1/4" access ports. An O-ring seal is also pre-installed to prevent leaks.

RSC-SLV-02



CATALOG NO.	DESCRIPTION	UOM	ORDER MULTIPLE
RSC-SLV-02	Sentry™ Refrigerant Locking Caps - 1/4", Silver, 2 pcs Pack	PK	1
RSC-SLV-04K	Sentry™ Refrigerant Locking Caps - 1/4", Silver, 4 pcs Pack w/1 Universal Key	PK	1
RSC-SLV-10	Sentry™ Refrigerant Locking Caps - 1/4", Silver, 10 pcs Pack	PK	1
RSC-SLV-50K	Sentry™ Refrigerant Locking Caps - 1/4", Silver, 50 pcs Pack w/2 Universal Keys	PK	1
RSC-SLV-500	Sentry™ Refrigerant Locking Caps - 1/4", Silver, 500 pcs Pack w/5 Driver Bits	PK	1



COPPER FITTINGS

Male Adapter C x M



CATALOG NO.	O.D. SIZE	I.D. SIZE	UOM	ORDER MULTIPLE
C101-0050	5/8" x 1/2"	1/2" x 1/2"	EA	25
C101-0100	7/8" x 3/4"	3/4" x 3/4"	EA	25
C101-0150	1-1/8" x 1"	1" x 1"	EA	10

Female Adapter C x F



CATALOG NO.	O.D. SIZE	I.D. SIZE	UOM	ORDER MULTIPLE
C105-0057	5/8" x 3/4"	1/2" x 3/4"	EA	25
C105-0100	7/8" x 3/4"	3/4" x 3/4"	EA	25
C105-0150	1-1/8" x 1"	1" x 1"	EA	10
C105-0215	1-3/8" x 1-1/4"	1-1/4" x 1-1/4"	EA	10

90 Degree Ell C x C



CATALOG NO.	O.D. SIZE	I.D. SIZE	UOM	ORDER MULTIPLE
C235-0002	3/8"	1/4"	EA	25
C235-0025	1/2"	3/8"	EA	25
C235-0050	5/8"	1/2"	EA	25
C235-0090	3/4"	5/8"	EA	25
C235-0100	7/8"	3/4"	EA	25
C235-0150	1-1/8"	1"	EA	10
C235-0215	1-3/8"	1-1/4"	EA	10

90 Degree Long Turn Street Ell Ftg. x C



CATALOG NO.	O.D. SIZE	I.D. SIZE	UOM	ORDER MULTIPLE
C272-0002	3/8"	1/4"	EA	25
C272-0025	1/2"	3/8"	EA	25
C272-0050	5/8"	1/2"	EA	25
C272-0090	3/4"	5/8"	EA	25
C272-0100	7/8"	3/4"	EA	10
C272-0150	1-1/8"	1"	EA	10
C272-0215	1-3/8"	1-1/4"	EA	10

90 Degree Street Ell Ftg. x C



CATALOG NO.	O.D. SIZE	I.D. SIZE	UOM	ORDER MULTIPLE
C254-0002	3/8"	1/4"	EA	25
C254-0100	7/8"	3/4"	EA	25
C254-0150	1-1/8"	1"	EA	10

45 Degree Ell C x C



CATALOG NO.	O.D. SIZE	I.D. SIZE	UOM	ORDER MULTIPLE
C290-0002	3/8"	1/4"	EA	25
C290-0025	1/2"	3/8"	EA	25
C290-0050	5/8"	1/2"	EA	25
C290-0090	3/4"	5/8"	EA	25
C290-0100	7/8"	3/4"	EA	25
C290-0150	1-1/8"	1"	EA	10
C290-0215	1-3/8"	1-1/4"	EA	60

COPPER FITTINGS cont'd

90 Degree Long Turn Ell C x C



CATALOG NO.	O.D. SIZE	I.D. SIZE	UOM	ORDER MULTIPLE
C242-0001	1/4"	1/8"	EA	25
C242-0002	3/8"	1/4"	EA	25
C242-0025	1/2"	3/8"	EA	25
C242-0050	5/8"	1/2"	EA	25
C242-0090	3/4"	5/8"	EA	25
C242-0100	7/8"	3/4"	EA	10
C242-0150	1-1/8"	1"	EA	10
C242-0215	1-3/8"	1-1/4"	EA	35
C242-0295	1-5/8"	1-1/2"	EA	25
C242-0390	2-1/8"	2"	EA	12

Coupling (Socket) with Rolled Tube Stop C x C



CATALOG NO.	O.D. SIZE	I.D. SIZE	UOM	ORDER MULTIPLE
C165-0001	1/4"	1/8"	EA	25
C165-0002	3/8"	1/4"	EA	25
C165-0025	1/2"	3/8"	EA	25
C165-0050	5/8"	1/2"	EA	25
C165-0090	3/4"	5/8"	EA	25
C165-0100	7/8"	3/4"	EA	25
C165-0150	1-1/8"	1"	EA	10
C165-0215	1-3/8"	1-1/4"	EA	10
C165-0295	1-5/8"	1-1/2"	EA	60
C165-0390	2-1/8"	2"	EA	40

Reducer Coupling w/Stop C x C



CATALOG NO.	O.D. SIZE	I.D. SIZE	UOM	ORDER MULTIPLE
C165-0007	3/8" x 1/4"	1/4" x 1/8"	EA	25
C165-0032	1/2" x 3/8"	3/8" x 1/4"	EA	25
C165-0058	5/8" x 1/2"	1/2" x 3/8"	EA	25
C165-0093	3/4" x 5/8"	5/8" x 1/2"	EA	25
C165-0094	3/4" x 1/2"	5/8" x 3/8"	EA	25
C165-0107	7/8" x 5/8"	3/4" x 1/2"	EA	25
C165-0149	7/8" x 3/4"	3/4" x 5/8"	EA	25
C165-0159	1-1/8" x 7/8"	1" x 3/4"	EA	10
C165-1498	1-1/8" x 3/4"	1" x 5/8"	EA	10
C165-0222	1-3/8" x 1-1/8"	1-1/4" x 1"	EA	10
C165-0223	1-3/8" x 7/8"	1-1/4" x 3/4"	EA	10
C165-0304	1-5/8" x 1-1/8"	1-1/2" x 1"	EA	10

45 Degree Street Ell Ftg. x C



CATALOG NO.	O.D. SIZE	I.D. SIZE	UOM	ORDER MULTIPLE
C295-0002	3/8"	1/4"	EA	25
C295-0090	3/4"	5/8"	EA	25
C295-0100	7/8"	3/4"	EA	25
C295-0150	1-1/8"	1"	EA	10

Fitting Reducer Coupling Ftg. x C



CATALOG NO.	O.D. SIZE	I.D. SIZE	UOM	ORDER MULTIPLE
C410-0032	1/2" x 3/8"	3/8" x 1/4"	EA	25
C410-0058	5/8" x 1/2"	1/2" x 3/8"	EA	25
C410-0093	3/4" x 5/8"	5/8" x 1/2"	EA	25
C410-0107	7/8" x 5/8"	3/4" x 1/2"	EA	25
C410-0149	7/8" x 3/4"	3/4" x 5/8"	EA	25
C410-0159	1-1/8" x 7/8"	1" x 3/4"	EA	10
C410-0222	1-3/8" x 1-1/8"	1-1/4" x 1"	EA	10

Cap



CATALOG NO.	O.D. SIZE	I.D. SIZE	UOM	ORDER MULTIPLE
C154-0100	7/8"	3/4"	EA	25

U-Type Strap



CATALOG NO.	O.D. SIZE	I.D. SIZE	UOM	ORDER MULTIPLE
C947-0025	1/2"	3/8"	EA	25
C947-0050	5/8"	1/2"	EA	25
C947-0100	7/8"	3/4"	EA	25
C947-0150	1-1/8"	1"	EA	25
C947-0215	1-3/8"	1-1/4"	EA	100
C947-0295	1-5/8"	1-1/2"	EA	100
C947-0390	2-1/8"	2"	EA	50

Copper Coupling with No Stop



CATALOG NO.	O.D. SIZE	I.D. SIZE	UOM	ORDER MULTIPLE
C172-0090	3/4"	5/8"	EA	25
C172-0100	7/8"	3/4"	EA	25
C172-0150	1-1/8"	1"	EA	10
C172-0215	1-3/8"	1-1/4"	EA	10

P-Traps



CATALOG NO.	O.D. SIZE	I.D. SIZE	UOM	ORDER MULTIPLE
C533-0050	5/8"	1/2"	EA	5
C533-0150	1-1/8"	1"	EA	3

Copper Coupling w/Dimple Stop



CATALOG NO.	O.D. SIZE	I.D. SIZE	UOM	ORDER MULTIPLE
C170-0003	5/16"	1/4"	EA	25

Tee C x C x C



CATALOG NO.	O.D. SIZE	I.D. SIZE	UOM	ORDER MULTIPLE
C460-0002	3/8"	1/4"	EA	25
C460-0025	1/2"	3/8"	EA	25
C460-0050	5/8"	1/2"	EA	25
C460-0090	3/4"	5/8"	EA	25
C460-0100	7/8"	3/4"	EA	10
C460-0150	1-1/8"	1"	EA	10

ACCESS FITTINGS

A convenient low-cost port for refrigeration servicing. May be installed in any position on either high or low side for charging, purging, quick testing or pressure checking. DiversiTech's access fittings have 1/4" SAE male flare access ports and include a quick seal cap and a stainless and brass special refrigerant valve core.

CATALOG NO.	DESCRIPTION	CONNECTION	QTY PER PACK	UOM	ORDER MULT.
VA-3-346	3 Way Solder Type, pack of 6	For 3/16" O.D. tube or 1/4" and 3/8" solder fitting	6	PK	1
VA-34	Straight Solder Type, pack of 6	3/16" O.D.S. x 1/4" O.D.F.	6	PK	1
VA-46	Straight Solder Type, pack of 6	1/4" O.D.S. x 3/8" O.D.F.	6	PK	1
VA-68	Straight Solder Type, pack of 6	3/8" O.D.S. x 1/2" O.D.F.	6	PK	1
VAU-24	Half Union, pack of 6	1/8" MPT	6	PK	1
VAU-45	Half Union, pack of 6	1/4" MPT	6	PK	1
VAX-2	Extended Copper Tube	1/8" O.D. tube	6	PK	1
VAX-3	Extended Copper Tube	3/16" O.D. x 1/8" I.D.	6	PK	1
VAX-4	Extended Copper Tube	1/4" O.D. x 3/16" I.D.	6	PK	1
VAX-5	Extended Copper Tube	5/16" O.D. x 1/4" I.D.	3	PK	1
VAX-6	Extended Copper Tube	3/8" O.D. x 5/16" I.D.	3	PK	1
VAX-8	Extended Copper Tube	1/2" O.D.	3	PK	1
VS-4	Swivel Nut w/Depressor, pack of 6	1/4" female flare forged swivel nut	6	PK	1
VST-4	Swivel Tee w/Permanent Depressor, pack of 3	1/4" Access on run x 1/4" female flare w/depressor on female swivel branch end	3	PK	1
VST-44	Swivel Tee w/Perm. Depressor, pack of 3	1/4" Access on run x 1/4" access on "T" - female swivel on run	3	PK	1
VTR-24	Threaded Tee, pack of 3	1/8" MPT x 1/4" male flare on run x access on branch	3	PK	1
VTS-10	Solder Tee Type	5/8" O.D. tube	1	EA	1
VTS-12	Solder Tee Type	3/4" O.D. tube	1	EA	1
VTS-14	Solder Tee Type	7/8" O.D. tube	1	EA	1
VTS-46	Solder Tee Type, pack of 3	1/4" O.D.S. x 5/16" O.D.F.	3	PK	1
VTS-56	Solder Tee Type, pack of 3	5/16" O.D.S. x 3/8" O.D.F.	3	PK	1
VTS-68	Solder Tee Type, pack of 3	3/8" O.D.S.	3	PK	1
VTS-810	Solder Tee Type, pack of 3	1/2" O.D.S.	3	PK	1
VC-4	Flare Cap, pack of 12	1/4"	12	PK	1
VC-4R	Flare Cap w/Core Remover, pack of 12	1/4"	12	PK	1
VVC-1	Valve Core, pack of 6		6	PK	1



Brass Adapters

The MSA-45 is used on the new R410 Mini Split systems that have the larger unique fitting on the service valve. The description of that fitting is 1/2" acme Male-20 UN. This adapter will screw onto the 1/2" Acme Male-20 UN fitting and allow you to connect a standard 1/4 service hose to it.



MSA-45

CATALOG NO.	DESCRIPTION	UOM	ORDER MULTIPLE
MSA-45	1/4" Male flare x 1/2" - 20 UNF Female	EA	1

Cop-Cap™ Locking Valve Cover

An effective way to discourage and prevent the removal of refrigerant. COP-CAP™ fits this standard service valve on all central AC units and mini-splits. It helps prevent access by unauthorized persons and can only be removed with the included special tool. Simply thread COP-CAP™ assembly onto existing 1/4" flare connection on system and lock set screw in place with hex wrench provided.

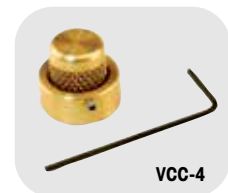

VCC-4

- Seals service valve to prevent leaks
- Prevents illegal venting or theft of refrigerant
- Stops unauthorized access in unsecured areas

CATALOG NO.	DESCRIPTION	UOM	ORDER MULTIPLE
VCC-4	Cop-Cap™, Pack of 2	PK	1
VCC-4B	Cop-Cap™ bulk, 100 per case	EA	100

LINE PIERCING VALVES AND TOOLS

Quick-Tap

Features a valve core in the 1/4" male port. Simply pierce the line and back seat the needle. Flow starts when depressor type charging hose is connected. Flow shuts off automatically when hose is removed. If valve core is not desired, it may be removed. Connect hose, pierce line and back seat needle. This method offers full unrestricted flow. Valve core can be removed or changed at any time without loss of refrigerant if needle is front seated.



CATALOG NO.	DESCRIPTION	UOM	ORDER MULTIPLE
QT-1	Quick-Tap – 1/4", 5/16", 3/8" O.D. Tube Size	EA	1
QT-2	Quick-Tap – 1/2", 5/8" O.D. Tube Size	EA	1

MAC—The Ultimate in Line Piercing Valves

Install valve. Connect charging hose. Service. That's all there is to it! MAC features uniport: 1 connection for piercing and servicing. Sealed with refrigerant resistant "O" rings. Needle automatically back seats after servicing, leaving line free of restriction. Connect to tubing with 2 socket-head screws. (Hex wrench is included with each valve.) Needle depressor is inserted into head of needle. Wing cap is turned down easily by hand until line is pierced. Wing cap is removed and system may be serviced with any charging hose with built-in depressor. When hose is removed, spring loaded needle back-seats forming a leak proof seal. Needle depressor is discarded and wing cap forms extra precautionary seal.



CATALOG NO.	DESCRIPTION	UOM	ORDER MULTIPLE
QTM-1	MAC Line Piercing Valve – 1/4", 5/16", 3/8" O.D. Tube Size	EA	36
QTM-2	MAC Line Piercing Valve – 1/2", 5/8" O.D. Tube Size	EA	36

Copper Saddle Valve

For copper-to-copper brazing. Penetrates line in one easy operation with no holes to drill. Steel pin with valve core pierces line and is locked into valve body by tightening cap. Teflon ring assures positive seal. Available in sizes from 1/4" to 1-1/8".



CATALOG NO.	DESCRIPTION	UOM	ORDER MULTIPLE
VLC-4	Copper Saddle Valve – 1/4" O.D. Tube Size, pack of 6	PK	1
VLC-5	Copper Saddle Valve – 5/16" O.D. Tube Size, pack of 6	PK	1
VLC-6	Copper Saddle Valve – 3/8" O.D. Tube Size, pack of 6	PK	1
VLC-8	Copper Saddle Valve – 1/2" O.D. Tube Size, pack of 4	PK	1
VLC-10	Copper Saddle Valve – 5/8" O.D. Tube Size, pack of 3	PK	1
VLC-12	Copper Saddle Valve – 3/4" O.D. Tube Size, pack of 2	PK	1
VLC-18	Copper Saddle Valve – 1-1/8" O.D. Tube Size, pack of 2	PK	1
VLC-25	Additional Teflon Rings, pack of 25	PK	1

Quick-Tap-2

Identical to Quick-Tap except that a nylon handle replaces the hex wrench. Phillips-head screws are used.



CATALOG NO.	DESCRIPTION	UOM	ORDER MULTIPLE
QTH-1	Quick-Tap-2 – 1/4", 5/16", 3/8" O.D. Tube Size	EA	1
QTH-2	Quick-Tap-2 – 1/2", 5/8" O.D. Tube Size	EA	1

Insta-Tap Refrigerant Recovery Tool

The fastest, easiest way to evacuate refrigerant before disposal of a unit. Snaps onto refrigerant line for full and immediate flow. Punctures super large hole for maximum full flow discharge to recovery unit. One tool fits all sizes from 3/16" to 7/8" O.D. hard tubing. Replaceable needle.



CATALOG NO.	DESCRIPTION	UOM	ORDER MULTIPLE
QT-100	Quick-Tap-2 – 1/4", 5/16", 3/8" O.D. Tube Size	EA	1
QT-100N	Replaceable Hardened Steel Needle and Gasket	EA	1
QT-100G	Replacement Gasket Only	EA	3

Core Storer

All steel valve core remover and storage container. Completely knurled for easier grip, eliminating slippage when using with oily or greasy hands. Core Storer features a compartment for storing extra valve cores. Four replacement cores are included with each tool.



CATALOG NO.	DESCRIPTION	UOM	ORDER MULTIPLE
VCR-1	Core Remover and Storer	EA	1

Core Removal Tool

Designed to remove and replace valve cores without losing the refrigerant charge. Connects to any 1/4" male flare fitting. Saves time, saves refrigerant.



CATALOG NO.	DESCRIPTION	UOM	ORDER MULTIPLE
VCR-1	Core Removal Tool	EA	1

BRASS FITTINGS

Compression Sleeve



CATALOG NO.	DESCRIPTION	UOM	ORDER MULTIPLE
D60A-4	1/4" Compression Sleeve	EA	100
D60A-8	1/2" Compression Sleeve	EA	100
D60A-10	5/8" Compression Sleeve	EA	100

Compression Connector



CATALOG NO.	DESCRIPTION	UOM	ORDER MULTIPLE
D68A-4B	1/4" x 1/4" Compression Connector	EA	10
D68A-6C	3/8" x 3/8" Compression Connector	EA	10

Compression Nut



CATALOG NO.	DESCRIPTION	UOM	ORDER MULTIPLE
D61A-4	1/4" Compression Nut	EA	10
D61A-8	1/2" Compression Nut	EA	10

Compression Elbow



CATALOG NO.	DESCRIPTION	UOM	ORDER MULTIPLE
D69A-4A	1/4" x 1/8" Compression Elbow	EA	10
D69A-8D	1/2" x 1/2" Compression Elbow	EA	10

Compression Union



CATALOG NO.	DESCRIPTION	UOM	ORDER MULTIPLE
D62A-44	1/4" Compression Union	EA	10
D62A-66	3/8" Compression Union	EA	10
D62A-88	1/2" Compression Union	EA	10
D62A-1010	5/8" Compression Union	EA	10

Compression Tee



CATALOG NO.	DESCRIPTION	UOM	ORDER MULTIPLE
D64A-44	1/4" Compression Tee	EA	10
D64A-66	3/8" Compression Tee	EA	10
D64A-88	1/2" Compression Tee	EA	10
D64A-1010	5/8" Compression Tee	EA	10

Flare x MIP Elbow



CATALOG NO.	DESCRIPTION	UOM	ORDER MULTIPLE
DE1-4B	1/4" Flare x 1/4" MIP Elbow	EA	10
DE1-6C	3/8" Flare x 3/8" MIP Elbow	EA	10
DE1-8D	1/2" Flare x 1/2" MIP Elbow	EA	10

Flare x MIP Reducing Elbow



CATALOG NO.	DESCRIPTION	UOM	ORDER MULTIPLE
DE1-6B	3/8" Flare x 1/4" MIP Reducing Elbow	EA	10
DE1-6D	3/8" Flare x 1/2" MIP Reducing Elbow	EA	10
DE1-8E	1/2" Flare x 3/4" MIP Reducing Elbow	EA	10
DE1-10D	5/8" Flare x 1/2" MIP Reducing Elbow	EA	10

Short Nut



CATALOG NO.	DESCRIPTION	UOM	ORDER MULTIPLE
DN1-3	3/16" Short Nut	EA	10
DN1-4	1/4" Short Nut	EA	10
DN1-6	3/8" Short Nut	EA	10
DN1-10	5/8" Short Nut	EA	10

Flare Tee



CATALOG NO.	DESCRIPTION	UOM	ORDER MULTIPLE
DT2-4	1/4" Flare Tee	EA	10
DT2-6	3/8" Flare Tee	EA	10
DT2-8	1/2" Flare Tee	EA	10
DT2-10	5/8" Flare Tee	EA	5

Cap



CATALOG NO.	DESCRIPTION	UOM	ORDER MULTIPLE
DN5-4	1/4" Cap	EA	10
DN5-6	3/8" Cap	EA	10

Flare x MIP Union



CATALOG NO.	DESCRIPTION	UOM	ORDER MULTIPLE
DU1-4B	1/4" Flare x 1/4" MIP Union	EA	10
DU1-6B	3/8" Flare x 1/4" MIP Union	EA	10
DU1-6C	3/8" Flare x 3/8" MIP Union	EA	10
DU1-6D	3/8" Flare x 1/2" MIP Union	EA	10
DU1-6E	3/8" Flare x 3/4" MIP Union	EA	10
DU1-8B	1/2" Flare x 1/4" MIP Union	EA	10
DU1-8D	1/2" Flare x 1/2" MIP Union	EA	10
DU1-8E	1/2" Flare x 3/4" MIP Union	EA	10
DU1-10D	5/8" Flare x 1/2" MIP Union	EA	10
DU1-10E	5/8" Flare x 3/4" MIP Union	EA	10
DU1-12D	3/4" Flare x 1/2" MIP Union	EA	10

Short Forged Flare Nut



CATALOG NO.	DESCRIPTION	UOM	ORDER MULTIPLE
DNS4-4	1/4" Short Forged Flare Nut	EA	10
DNS4-6	3/8" Short Forged Flare Nut	EA	10
DNS4-8	1/2" Short Forged Flare Nut	EA	10
DNS4-10	5/8" Short Forged Flare Nut	EA	10
DNS4-12	3/4" Short Forged Flare Nut	EA	10
DNS4-14	7/8" Short Forged Flare Nut	EA	5

Flare Union

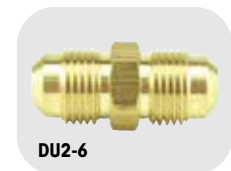

CATALOG NO.	DESCRIPTION	UOM	ORDER MULTIPLE
DU2-4	1/4" Flare Union	EA	10
DU2-6	3/8" Flare Union	EA	10
DU2-8	1/2" Flare Union	EA	10
DU2-10	5/8" Flare Union	EA	10
DU2-12	3/4" Flare Union	EA	10

Plug



CATALOG NO.	DESCRIPTION	UOM	ORDER MULTIPLE
DP2-4	1/4" Plug	EA	10
DP2-6	3/8" Plug	EA	10
DP2-8	1/2" Plug	EA	10
DP2-10	5/8" Plug	EA	10

BRASS FITTINGS cont'd

Flare x FIP Union



CATALOG NO.	DESCRIPTION	UOM	ORDER MULTIPLE
DU3-6D	3/8" x 1/2" Flare x FIP Union	EA	10
DU3-10E	5/8" x 3/4" Flare x FIP Union	EA	10

Flare x Flare Swivel Union



CATALOG NO.	DESCRIPTION	UOM	ORDER MULTIPLE
DUS4-4	1/4" Flare x 1/4" Flare Swivel Union	EA	10
DUS4-6	3/8" Flare x 3/8" Flare Swivel Union	EA	10

CUSHION CLAMPS

Cushion Clamps

An industry standard universal clamp that mounts to standard strut. Steel with electro-dichromate finish to resist corrosion. The lock nut has a nylon insert for a positive lock. The polymeric grommet withstands temperatures from -25°C to 125°C and resists the effects of most oils, chemicals, and industrial cleaning compounds.



CATALOG NO.	DESCRIPTION	UOM	ORDER MULTIPLE
538-1/4	Cushion Clamp – 1/4"	EA	25
538-3/8	Cushion Clamp – 3/8"	EA	25
538-1/2	Cushion Clamp – 1/2"	EA	25
538-5/8	Cushion Clamp – 5/8"	EA	25
538-3/4	Cushion Clamp – 3/4"	EA	25
538-7/8	Cushion Clamp – 7/8"	EA	25
538-1-1/8	Cushion Clamp – 1-1/8"	EA	10
538-1-3/8	Cushion Clamp – 1-3/8"	EA	10
538-1-5/8	Cushion Clamp – 1-5/8"	EA	10
538-2-1/8	Cushion Clamp – 2-1/8"	EA	10
538-2-5/8	Cushion Clamp – 2-5/8"	EA	10
538-3-1/8	Cushion Clamp – 3-1/8"	EA	10
538-4-1/8	Cushion Clamp – 4-1/8"	EA	10

Liquid Line Driers

High moisture and acid capacity. Maximum filtration capacity. Exceptional compatibility with new polyester oils. Compatible with all existing and new refrigerants and blends including 134a, 401A/B, 402A/B, 404A, 407A/B/C, 410A, 502, 507A. Spring loaded, molecular sieve XH-9 dessicant. Solid copper sweat fittings. Powder paint exterior coating surpasses 500 hour ASTM salt spray test and resists corrosion. Eliminates concern of additive stripping.



Suction Line Driers

The solid-core clean-up dryer was developed for use in a system suction line. The compact design incorporates a large outside diameter shell, which results in a shorter lay-in length, and a larger core, which provides a greater filtration area for maximum operating efficiency. The core material has controlled porosity which effectively removes and holds a maximum amount of contaminants with a minimum of pressure drop. It collects and holds inorganic acids and other harmful contaminants from a motor burnout. This binding process protects the core from acid decomposition. Access valves on both the inlet and outlet sides make it easy to measure pressure accurately. Occasionally, enough contaminant matter may collect in the filter core to cause a slight pressure drop. The access valves on the SLD make it easy to determine if a pressure drop exists and to measure the amount of the drop. The original DSLD, solid core, XH-9 molecular sieve dessicant suction line filter dryer. High acid capacity. Low pressure drop – exceptionally high flow rates. Designed for system clean-up. 500 hours salt spray protection. Shortest system cut-out lengths allow installation in tight areas. Two access valves simplify pressure drop measurement. Flare or solid copper sweat fittings.



CATALOG NO.	VIRGINIA KMP	CONNECTION	CUBIC INCH	UOM	ORDER MULTIPLE
DAD032	WLD-032 FLARE	1/4	3	EA	1
DAD032S	WLD-032 SWEAT	1/4	3	EA	1
DAD052	WLD-052 FLARE	1/4	5	EA	1
DAD052S	WLD-052 SWEAT	1/4	5	EA	1
DAD053S	WLD-053 SWEAT	3/8	5	EA	1
DAD082	WLD-082 FLARE	1/4	8	EA	1
DAD082S	WLD-082 SWEAT	1/4	8	EA	1
DAD083S	WLD-083 SWEAT	3/8	8	EA	1
DAD084S	WLD-084 SWEAT	1/2	8	EA	1
DAD163	WLD-163 FLARE	3/8	16	EA	1
DAD163S	WLD-163 SWEAT	3/8	16	EA	1
DAD164S	WLD-164 SWEAT	1/2	16	EA	1
DAD303	WLD303 FLARE	3/8	30	EA	1
DAD303S	WLD-303 SWEAT	3/8	30	EA	1
DAD304S	WLD-304 SWEAT	1/2	30	EA	1
DAD305	WLD-305 FLARE	5/8	30	EA	1

CATALOG NO.	VIRGINIA KMP	CONNECTION	CUBIC INCH	UOM	ORDER MULTIPLE
DSL13-5SVHH	AL-24-55C Sweat	5/8	13	EA	1
DSL13-6SVHH	AL-30-6SC Sweat	3/4	13	EA	1
DSL27-7SVHH	AL-30-7SC Sweat	7/8	27	EA	1
DSL27-9SVHH	AL-44-9SC Sweat	1-1/8	27	EA	1

Universal Spun Copper Driers

Manufactured with the latest generation molecular sieves compatible with more than 20 different types of refrigerants, including R-134A. They can be used in all hermetic and open refrigeration systems using CFC, HCFC and HFC gases and mixes such as commercial and domestic refrigerators, freezers and air conditioners ranging from 1/8 to 2.0 HP. Hermetically sealed with extended ends.



CATALOG NO.	OUTLET	INLET	DIAMETER	LENGTH GRAMS	DESSICANT R12	RECOMM. R22	TONNAGE QUANTITY	UOM	ORDER MULTIPLE
DX-3	1/4"	1/4"	3/4"	7-11/16"	10	1/3	1/2	EA	24
DX-4	Multiple	1/4"	1"	9"	18	3/4	1-1/2	EA	1
DXA-5	1/4"	1/4"	1"	9-1/4"	20	3/4	1-1/2	EA	1

DRIERS, SIGHT GLASSES cont'd

Bi Flow Driers

The "DBF" Series is designed specifically for heat pump or reverse cycle application. External check valves are not required since they are incorporated within the filter dryer shell. The core design filters out contaminant particles down to 25 microns. 100% copper sweat or nickel plated flare fittings. Desiccant core provides reliable and effective, removal of solid contaminants, acid and moisture. Provides three times the filtration as the standard bi-flow. Core is cushioned in fiber gaskets to protect core and to insure trouble-free performance. Powder paint exterior coating surpasses 500 hour ASTM salt spray test and resists corrosion.



DBF163S

CATALOG NO.	VIRGINIA KMP	CONNECTION	CUBIC INCH	UOM	ORDER MULTIPLE
DBF083S	V2A-083 Sweat	3/8	8	EA	1
DBF084S	V2A-084 Sweat	1/2	8	EA	1
DBF163	V2A-163 Flare	3/8	16	EA	1
DBF163S	V2A-163 Sweat	3/8	16	EA	1
DBF164S	V2A-164 Sweat	1/2	16	EA	1
DBF165S	V2A-165S Sweat	5/8	16	EA	1

Sight Glasses

Sight Glass and Moisture Indicator provides a quick visual diagnosis of refrigerant and moisture levels within a system. The sight glass indicates if the system has the proper refrigerant level, a restricted dryer or excessive pressure-drop. The moisture indicator recognizes moisture within the system. Provides early warning that a potential failure exists resulting in corrosion, chemical damage, restricted flow, or even compressor failure. Etch-resistant glass with a simple color comparison provides easy viewing and quick diagnostics. Flare models feature forged brass body and fittings for corrosion resistance. Sweat models feature copper fittings to permit solder installation without disassembly. Leak-proof design is compact and short in length to easily fit within a unit and provide accuracy in performance.



DPSG-2S

CATALOG NO.	VIRGINIA KMP	DESCRIPTION	CONNECTION	UOM	ORDER MULTIPLE
DPSG-3MF	LDE-3-MF	MALE/FEMALE	3/8	EA	1
DPSG-2S	LDE-2-S	SWEAT	1/4	EA	1
DPSG-3S	LDE-3-S	SWEAT	3/8	EA	1

REFRIGERANT CHARGING

Insta-Charge

Faster, safer and more economical method for charging LIQUID refrigerant through the low pressure side of an air conditioning or refrigeration system, without damaging the compressor. Insta-Charge's unique internal restrictor reduces liquid flow to a level below the capacity of the compressor. Converts liquid refrigerant to a saturated vapor for fast entry. Insta-Charge connects directly to the refrigerant can or cylinder valve. Adds liquid tracing dye faster. Eliminates heating of refrigerant cylinder. Made of light weight aluminum. Sold at a fraction of the cost of other fast charging devices.



RC-1

CATALOG NO.	DESCRIPTION	UOM	ORDER MULTIPLE
RC-1	Insta-Charge	EA	1

REFRIGERANT TUBING

DiversiTech Line Sets

DiversiTech Line Sets are individually packaged in sturdy corrugated cardboard, designed and tested for individual parcel shipment.

Line Sets are designed for air conditioning and refrigeration systems. The copper tube is refrigeration grade tubing to ASTM B280. The suction line is pre-insulated with Armaflex AP pipe insulation. This insulation is a black flexible elastomeric thermal insulation. The expanded closed-cell structure makes it an efficient insulation. It is manufactured without the use of CFC's, HFC's or HCFC's. AP Armaflex contains Microban® antimicrobial product protection for added defense against mold on the insulation. DiversiTech Min-Split Line Sets are similar to Standard

Line Sets but come with additional insulation on the liquid line and flared line ends. Copper tubing complies with ASTM B280 for Seamless Copper Tube for ACR.

AP Armaflex insulation meets ASTM C534, Type I – Tubular Grade 1, ASTM E84, NFPA 255, UL723, CAN/ULC S102, UL94 5V-5A, V-0 (E55798), NFPA 90A/90B, UL181, ASTM G21/C1338, ASTM G22, ASTM D1056 2B1, MIL-P-15280J form T, MIL-C-3133C grade SB E3, MEA 96-85-M, and City of LA RR7642.



STANDARD LINE SETS

CATALOG NO.	LENGTH (FT)	INSULATION WALL	SUCTION LINE	LIQUID LINE	UOM	ORDER MULTIPLE
D61220250	25	1/2	3/4	3/8	EA	1
D61220300	30	1/2	3/4	3/8	EA	1
D61220350	35	1/2	3/4	3/8	EA	1
D61220400	40	1/2	3/4	3/8	EA	1
D61220500	50	1/2	3/4	3/8	EA	1
D61230250	25	3/4	3/4	3/8	EA	1
D61230400	40	3/4	3/4	3/8	EA	1
D61230500	50	3/4	3/4	3/8	EA	1
D61280250	25	3/8	3/4	3/8	EA	1
D61280300	30	3/8	3/4	3/8	EA	1
D61280350	35	3/8	3/4	3/8	EA	1
D61280400	40	3/8	3/4	3/8	EA	1
D61280500	50	3/8	3/4	3/8	EA	1
D61420250	25	1/2	7/8	3/8	EA	1
D61420300	30	1/2	7/8	3/8	EA	1
D61420350	35	1/2	7/8	3/8	EA	1
D61420400	40	1/2	7/8	3/8	EA	1
D61420500	50	1/2	7/8	3/8	EA	1
D61430300	30	3/4	7/8	3/8	EA	1
D61430350	35	3/4	7/8	3/8	EA	1
D61430400	40	3/4	7/8	3/8	EA	1
D61430500	50	3/4	7/8	3/8	EA	1
D61480250	25	3/8	7/8	3/8	EA	1
D61480300	30	3/8	7/8	3/8	EA	1
D61480350	35	3/8	7/8	3/8	EA	1
D61480400	40	3/8	7/8	3/8	EA	1
D61480500	50	3/8	7/8	3/8	EA	1
D61820250	25	3/8	1-1/8	1/2	EA	1
D61820500	50	3/8	1-1/8	1/2	EA	1
D61830250	25	3/4	1-1/8	3/8	EA	1
D61830300	30	3/4	1-1/8	3/8	EA	1
D61830350	35	3/4	1-1/8	3/8	EA	1
D61830400	40	3/4	1-1/8	3/8	EA	1
D61880250	25	3/8	1-1/8	3/8	EA	1
D61880300	30	3/8	1-1/8	3/8	EA	1
D61880400	40	3/8	1-1/8	3/8	EA	1
D61880500	50	3/8	1-1/8	3/8	EA	1
D61210250	25	1	3/4	3/8	EA	1
D61210300	30	1	3/4	3/8	EA	1
D61210350	35	1	3/4	3/8	EA	1
D61210400	40	1	3/4	3/8	EA	1
D61210500	50	1	3/4	3/8	EA	1
D61410250	25	1	7/8	3/8	EA	1
D61410300	30	1	7/8	3/8	EA	1
D61410350	35	1	7/8	3/8	EA	1
D61410400	40	1	7/8	3/8	EA	1
D61410500	50	1	7/8	3/8	EA	1
D61810250	25	1	1-1/8	3/8	EA	1
D61810400	40	1	1-1/8	3/8	EA	1
D61810500	50	1	1-1/8	3/8	EA	1

MINI-SPLIT LINE SETS

CATALOG NO.	LENGTH (FT)	INSULATION WALL	SUCTION LINE	LIQUID LINE	UOM	ORDER MULTIPLE
D40680250B3B6	25	3/8	3/8	1/4	EA	1
D40680350B3B6	35	3/8	3/8	1/4	EA	1
D40680500B3B6	50	3/8	3/8	1/4	EA	1
D40880250B3B6	25	3/8	1/2	1/4	EA	1
D40880350B3B6	35	3/8	1/2	1/4	EA	1
D40880500B3B6	50	3/8	1/2	1/4	EA	1
D41080250B3B6	25	3/8	5/8	1/4	EA	1
D41080350B3B6	35	3/8	5/8	1/4	EA	1
D41080500B3B6	50	3/8	5/8	1/4	EA	1
D61080250B3B6	25	3/8	5/8	3/8	EA	1
D61080350B3B6	35	3/8	5/8	3/8	EA	1
D61080500B3B6	50	3/8	5/8	3/8	EA	1
D40620250B3B6	25	1/2	3/8	1/4	EA	1
D40620350B3B6	35	1/2	3/8	1/4	EA	1
D40620500B3B6	50	1/2	3/8	1/4	EA	1
D40820250B3B6	25	1/2	1/2	1/4	EA	1
D40820350B3B6	35	1/2	1/2	1/4	EA	1
D40820500B3B6	50	1/2	1/2	1/4	EA	1
D41020250B3B6	25	1/2	5/8	1/4	EA	1
D41020350B3B6	35	1/2	5/8	1/4	EA	1
D41020500B3B6	50	1/2	5/8	1/4	EA	1
D61020250B3B6	25	1/2	5/8	3/8	EA	1
D61020350B3B6	35	1/2	5/8	3/8	EA	1
D61020500B3B6	50	1/2	5/8	3/8	EA	1

If ordering by pallet, 15 line sets are packed per pallet.

LineSet Box™

The NEW LINESET BOX™ is a rough-in box for new construction line set protection for all types of HVAC installations. The architecturally pleasing and professional looking LINESET BOX is easy to install and provides superior protection of refrigerant line sets and condensate drain lines. Provides a clean termination point for new construction projects and reserves the bay for the HVAC system installation. The LINESET BOX also protects the lineset from damage during construction. It helps to eliminate damage such as kinks that can drastically increase HVAC installation time.



CATALOG NO.	DESCRIPTION	UOM	ORDER MULTIPLE
LSB10-W	LINESET BOX™ - White	EA	1
LSB10-BL	LINESET BOX™ - Black	EA	1

DiversiTech Tear-Resistant Line Sets

Designed for air conditioning and refrigeration systems, the new DiversiTech Tear-Resistant Line sets include a durable flexible polymeric jacket that minimizes insulation damage and easily conforms to bends. Simplifying installation and saving technician time, an expanded closed-cell structure and unique formation resists moisture vapor intrusion and UV damage. No field-applied coating or jacket translates to more installs in a day. Refrigeration grade copper tubing conforms to ATSM B280. These new Tear-Resistant Standard Line Sets are available in a wide range of sizes and lengths to serve all standard application requirements.



CATALOG NO.	LENGTH (FT)	INSULATION WALL	SUCTION LINE	LIQUID LINE	UOM	ORDER MULTIPLE
D612K0250	25	1/2	3/4	3/8	EA	1
D612K0300	30	1/2	3/4	3/8	EA	1
D612K0350	35	1/2	3/4	3/8	EA	1
D612K0400	40	1/2	3/4	3/8	EA	1
D612K0500	50	1/2	3/4	3/8	EA	1
D614K0250	25	1/2	7/8	3/8	EA	1
D614K0350	35	1/2	7/8	3/8	EA	1
D614K0400	40	1/2	7/8	3/8	EA	1
D614K0500	50	1/2	7/8	3/8	EA	1
D618K0250	25	1/2	1-1/8	3/8	EA	1
D614K0300	30	1/2	1-1/8	3/8	EA	1
D618K0400	40	1/2	1-1/8	3/8	EA	1
D618K0500	50	1/2	1-1/8	3/8	EA	1
D612L0250	25	3/4	3/4	3/8	EA	1
D612L0300	30	3/4	3/4	3/8	EA	1
D612L0350	35	3/4	3/4	3/8	EA	1
D612L0400	40	3/4	3/4	3/8	EA	1
D612L0500	50	3/4	3/4	3/8	EA	1
D614L0250	25	3/4	7/8	3/8	EA	1
D614L0350	35	3/4	7/8	3/8	EA	1
D614L0400	40	3/4	7/8	3/8	EA	1
D614L0500	50	3/4	7/8	3/8	EA	1
D618L0250	25	3/4	1-1/8	3/8	EA	1
D614L0300	30	3/4	1-1/8	3/8	EA	1
D618L0400	40	3/4	1-1/8	3/8	EA	1
D618L0500	50	3/4	1-1/8	3/8	EA	1
D612M0250	25	1	3/4	3/8	EA	1
D612M0300	30	1	3/4	3/8	EA	1
D612M0350	35	1	3/4	3/8	EA	1
D612M0400	40	1	3/4	3/8	EA	1
D612M0500	50	1	3/4	3/8	EA	1
D614M0250	25	1	7/8	3/8	EA	1
D614M0300	30	1	7/8	3/8	EA	1
D614M0350	35	1	7/8	3/8	EA	1
D614M0400	40	1	7/8	3/8	EA	1
D614M0500	50	1	7/8	3/8	EA	1
D618M0250	25	1	1-1/8	3/8	EA	1
D618M0300	30	1	1-1/8	3/8	EA	1
D618M0400	40	1	1-1/8	3/8	EA	1
D618M0500	50	1	1-1/8	3/8	EA	1

DiversiTech Tear-Resistant Mini-Split Line Sets

Designed for Mini-Split air conditioning systems, DiversiTech offers a new line of Tear-Resistant Line Sets that simplify installation and save technician time with no field-applied coating required. A durable polymeric jacket minimizes installation damage and easily conforms to bends, and an expanded closed-cell structure and unique formulation resists moisture vapor intrusion and UV damage. Refrigeration grade copper tubing conforms to ATSM B280. These new Mini-Split Tear-Resistant Line Sets are available in a wide range of sizes and lengths. Available with or without fittings.



CATALOG NO.	LENGTH (FT)	INSULATION WALL	SUCTION LINE	LIQUID LINE	UOM	ORDER MULTIPLE
D406K0250B3B6	25	1/2	3/8	1/4	EA	1
D406K0350B3B6	35	1/2	3/8	1/4	EA	1
D406K0500B3B6	50	1/2	3/8	1/4	EA	1
D408K0250B3B6	25	1/2	1/2	1/4	EA	1
D408K0350B3B6	35	1/2	1/2	1/4	EA	1
D408K0500B3B6	50	1/2	1/2	1/4	EA	1
D410K0250B3B6	25	1/2	5/8	1/4	EA	1
D410K0350B3B6	35	1/2	5/8	1/4	EA	1
D410K0500B3B6	50	1/2	5/8	1/4	EA	1
D610K0250B3B6	25	1/2	5/8	3/8	EA	1
D610K0350B3B6	35	1/2	5/8	3/8	EA	1
D610K0500B3B6	50	1/2	5/8	3/8	EA	1
D406L0250B3B6	25	3/4	3/8	1/4	EA	1
D406L0350B3B6	35	3/4	3/8	1/4	EA	1
D406L0500B3B6	50	3/4	3/8	1/4	EA	1
D408L0250B3B6	25	3/4	1/2	1/4	EA	1
D408L0350B3B6	35	3/4	1/2	1/4	EA	1
D408L0500B3B6	50	3/4	1/2	1/4	EA	1
D410L0250B3B6	25	3/4	5/8	1/4	EA	1
D410L0350B3B6	35	3/4	5/8	1/4	EA	1
D410L0500B3B6	50	3/4	5/8	1/4	EA	1
D610L0250B3B6	25	3/4	5/8	3/8	EA	1
D610L0350B3B6	35	3/4	5/8	3/8	EA	1
D610L0500B3B6	50	3/4	5/8	3/8	EA	1
D406M0250B3B6	25	1	3/8	1/4	EA	1
D406M0350B3B6	35	1	3/8	1/4	EA	1
D406M0500B3B6	50	1	3/8	1/4	EA	1
D408M0250B3B6	25	1	1/2	1/4	EA	1
D408M0350B3B6	35	1	1/2	1/4	EA	1
D408M0500B3B6	50	1	1/2	1/4	EA	1
D410M0250B3B6	25	1	5/8	1/4	EA	1
D410M0350B3B6	35	1	5/8	1/4	EA	1
D410M0500B3B6	50	1	5/8	1/4	EA	1
D610M0250B3B6	25	1	5/8	3/8	EA	1
D610M0350B3B6	35	1	5/8	3/8	EA	1
D610M0500B3B6	50	1	5/8	3/8	EA	1

If ordering by pallet, 15 line sets are packed per pallet.

REFRIGERANT TUBING cont'd

White Pipe™

White Pipe™ pre-insulated refrigerant line is ideal for a variety of installation jobs and works for every air conditioning application including ductless mini-split, heat pump and centralized air ducted units. Available in a variety of sizes and lengths.



Flexible Refrigerant Line

Flexible Refrigerant Line, with installed flare nut, allows a kink-free connection from the mini-split wall unit to the lineset for easier and faster installation.



CATALOG NO.	DESCRIPTION	UOM	ORDER MULTIPLE
WP1214-50	White Pipe, 1/4 x 1/2 in x 50 ft	EA	13
WP1238-50	White Pipe, 3/8 x 1/2 in x 50 ft	EA	11
WP1212-50	White Pipe, 1/2 x 1/2 in x 50 ft	EA	10
WP1258-50	White Pipe, 5/8 x 1/2 in x 50 ft	EA	7
WP1234-50	White Pipe, 3/4 x 1/2 in x 50 ft	EA	5
WP1278-50	White Pipe, 7/8 x 1/2 in x 50 ft	EA	5
WP1214-164	White Pipe, 1/4 x 1/2 in x 164 ft	EA	5
WP1238-164	White Pipe, 3/8 x 1/2 in x 164 ft	EA	4
WP1212-164	White Pipe, 1/2 x 1/2 in x 164 ft	EA	4
WP1258-164	White Pipe, 5/8 x 1/2 in x 164 ft	EA	3
WP1234-82	White Pipe, 3/4 x 1/2 in x 82 ft	EA	3
WP1278-82	White Pipe, 7/8 x 1/2 in x 82 ft	EA	3

CATALOG NO.	DESCRIPTION	UOM	ORDER MULTIPLE
FRL14-F	Flexible Refrigerant Line – 1/4 in. x 36"	EA	15
FRL38-F	Flexible Refrigerant Line – 3/8 in. x 36"	EA	14
FRL12-F	Flexible Refrigerant Line – 1/2 in. x 36"	EA	11
FRL58-F	Flexible Refrigerant Line – 5/8 in. x 36"	EA	10

REFRIGERANT LABELS

DiversiTech Refrigerant ID Labels

Refrigerant labels are designed for proper identification of refrigerant in a recovery cylinder. These 3" x 4" self-adhesive vinyl refrigeration labels use a high-tack acrylic adhesive and UV cured screen printing. Each label indicates the type of refrigerant (eg. R-438A), the chemical name (eg. pentafluoroethane) and the UN No. (eg. UN3163).



- Color coded
- Large and easy to read refrigerant identification
- Durable UV cured screen printed

CATALOG NO.	DESCRIPTION	UOM	ORDER MULTIPLE
REFRIGERANT IDENTIFICATION LABELS (3" x 4")			
04022	R-22 Refrigerant ID Labels, pack of 10	PK	1
04134	R-134a Refrigerant ID Labels, pack of 10	PK	1
04404	R-404A (HP62/FX70) Refrigerant ID Labels, pack of 10	PK	1
04407	R-407C (SUVA 9000/KLEA 66) Refrigerant ID Labels, pack of 10	PK	1
04410	R-410A (AZ20) Refrigerant ID Labels, pack of 10	PK	1
04099	R-438A Refrigerant ID Labels, pack of 10	PK	1
04402	R-402A Refrigerant ID Labels, pack of 10	PK	1
04421	R-421A Refrigerant ID Labels, pack of 10	PK	1
04137	R-437A Refrigerant ID Labels, pack of 10	PK	1
SYSTEM REFRIGERANT/OIL LABELS (3" x 4")			
04850	Refrigerant Removed Labels, pack of 10	PK	1

REFRIGERANT RECOVERY PRODUCTS

Refrigerant Recovery Cylinders

DOT Classified for recovery, recycling, service and reclaim. Liquid and vapor valves ("Y" valve or separate valve configurations) are installed in all cylinders. Painted yellow/gray per ARI guidelines. Float switches have 3-pin Brad Harrison connectors.

CATALOG NO.	DESCRIPTION	DOT CLASS	3/4" NPT PLUG	FLOAT SWITCH	WATER CAP.	TARE WT.	UOM	ORDER MULTIPLE
02033	30 lb.	4BA400	YES	NO	26.2 lbs.	17 lbs.	EA	1
02053	50 lb.	4BA400	YES	NO	47.7 lbs.	28 lbs.	EA	1
02100	100 lb.	4BW400	NO	NO	123 lbs.	48 lbs.	EA	1
02255	250 lb.	4BW260	YES	NO	239 lbs.	85 lbs.	EA	1



Caution: Never overfill cylinders. Maximum refrigerant capacity is limited to 80% of the water capacity of the cylinder in lbs. (see table above). DOT requires cylinders to be refested every five years. Some recovery equipment uses weight scales to cut off refrigerant fill at 80% of capacity. Be sure cylinder tare weight is correct for this type of equipment.

DOT Classification Example: 4BA400: 400 psi working pressure; 800 psi test pressure (double the working pressure); 1,600 psi minimum burst pressure (double the test pressure). Pressure relief/safety valve is set to release at between 75-100% of the test pressure. For example, in the 4BA400 tanks which have a 800 psi test pressure, the relief valve opens at between 600 psi and 800 psi.

TUBING INSULATION

Tubing Insulation

Highest quality tubing insulation by Armacell. AC Accoflex® tubing insulation is a flexible rubber product from the inventors of elastomeric foam insulation. It is designed exclusively for HVAC, with a tough surface and excellent resistance to ultraviolet damage, condensation and mold.



3/8" WALL

CATALOG NO.	DESCRIPTION	TOTAL FEET	UOM	ORDER MULTIPLE
7-3838	3/8" ID x 3/8" Wall, pack of 100,	600'	PK	1
7-3812	1/2" ID x 3/8" Wall, pack of 80	480'	PK	1
7-3858	5/8" ID x 3/8" Wall, pack of 65	390'	PK	1
7-3834	3/4" ID x 3/8" Wall, pack of 55	330'	PK	1
7-3878	7/8" ID x 3/8" Wall, pack of 45	270'	PK	1
7-381-18	1-1/8" ID x 3/8" Wall, pack of 35	210'	PK	1
7-381-38	1-3/8" ID x 3/8" Wall, pack of 30	180'	PK	1
7-381-58	1-5/8" ID x 3/8" Wall, pack of 20	120'	PK	1
7-382-18	2-1/8" ID x 3/8" Wall, pack of 16	96'	PK	1
7-382-58	2-5/8" ID x 3/8" Wall, pack of 12	72'	PK	1

3/4" WALL

CATALOG NO.	DESCRIPTION	TOTAL FEET	UOM	ORDER MULTIPLE
7-3438	3/8" ID x 3/4" Wall, pack of 40	240'	PK	1
7-3412	1/2" ID x 3/4" Wall, pack of 35	210'	PK	1
7-3458	5/8" ID x 3/4" Wall, pack of 24	144'	PK	1
7-3434	3/4" ID x 3/4" Wall, pack of 23	138'	PK	1
7-3478	7/8" ID x 3/4" Wall, pack of 20	120'	PK	1
7-341-18	1-1/8" ID x 3/4" Wall, pack of 15	90'	PK	1
7-341-58	1-5/8" ID x 3/4" Wall, pack of 10	60'	PK	1
7-342-18	2-1/8" ID x 3/4" Wall, pack of 9	54'	PK	1
7-342-58	2-5/8" ID x 3/4" Wall, pack of 8	48'	PK	1

1/2" WALL

CATALOG NO.	DESCRIPTION	TOTAL FEET	UOM	ORDER MULTIPLE
7-1238	3/8" ID x 1/2" Wall, pack of 75	450'	PK	1
7-1212	1/2" ID x 1/2" Wall, pack of 66	396'	PK	1
7-1258	5/8" ID x 1/2" Wall, pack of 50	300'	PK	1
7-1234	3/4" ID x 1/2" Wall, pack of 40	240'	PK	1
7-1278	7/8" ID x 1/2" Wall, pack of 35	210'	PK	1
7-121-18	1-1/8" ID x 1/2" Wall, pack of 25	150'	PK	1
7-121-38	1-3/8" ID x 1/2" Wall, pack of 20	120'	PK	1
7-121-58	1-5/8" ID x 1/2" Wall, pack of 15	90'	PK	1
7-122-18	2-1/8" ID x 1/2" Wall, pack of 10	60'	PK	1
7-122-58	2-5/8" ID x 1/2" Wall, pack of 10	60'	PK	1
7-123-18	3-1/8" ID x 1/2" Wall, pack of 7	42'	PK	1

1" WALL

CATALOG NO.	DESCRIPTION	TOTAL FEET	UOM	ORDER MULTIPLE
7-1058	5/8" ID x 1" Wall, pack of 20	120'	PK	1
7-1078	7/8" ID x 1" Wall, pack of 15	90'	PK	1

TUBING INSULATION cont'd

Self-Sealing Split Tubing Insulation

The Tubolit® semi-slit tubing insulation is made of 100% non-particulating polyethylene foam pipe insulation. Its closed-cell structure won't wick moisture and helps prevent the absorption of condensation that could cause mold to develop over time. It is pre-slit with a factory applied pressure sensitive adhesive to both seam surfaces and has a release liner for easy installation. Available in 3/8", 1/2", 3/4" and 1" wall thickness options with inner diameters from 3/8" to 3-1/8".



3/8" WALL

CATALOG NO.	DESCRIPTION	TOTAL FEET	UOM	ORDER MULTIPLE
7-S3838	3/8" ID x 3/8" Wall, pack of 90	540'	PK	1
7-S1238	1/2" ID x 3/8" Wall, pack of 76	456'	PK	1
7-S5838	5/8" ID x 3/8" Wall, pack of 66	396'	PK	1
7-S3438	3/4" ID x 3/8" Wall, pack of 50	300'	PK	1
7-S7838	7/8" ID x 3/8" Wall, pack of 46	276'	PK	1
7-S11838	1-1/8" ID x 3/8" Wall, pack of 37	222'	PK	1
7-S13838	1-3/8" ID x 3/8" Wall, pack of 30	180'	PK	1
7-S15838	1-5/8" ID x 3/8" Wall, pack of 23	138'	PK	1
7-S11038	1-1/2" ID x 3/8" Wall, pack of 21	126'	PK	1
7-S21838	2-1/8" ID x 3/8" Wall, pack of 16	96'	PK	1
7-S20038	2-3/8" ID x 3/8" Wall, pack of 14	84'	PK	1
7-S25838	2-5/8" ID x 3/8" Wall, pack of 12	72'	PK	1
7-S21038	2-7/8" ID x 3/8" Wall, pack of 10	60'	PK	1
7-S31838	3-1/8" ID x 3/8" Wall, pack of 9	54'	PK	1

1/2" WALL

CATALOG NO.	DESCRIPTION	TOTAL FEET	UOM	ORDER MULTIPLE
7-S3812	3/8" ID x 1/2" Wall, pack of 69	414'	PK	1
7-S1212	1/2" ID x 1/2" Wall, pack of 56	336'	PK	1
7-S5812	5/8" ID x 1/2" Wall, pack of 50	300'	PK	1
7-S3412	3/4" ID x 1/2" Wall, pack of 44	264'	PK	1
7-S7812	7/8" ID x 1/2" Wall, pack of 40	240'	PK	1
7-S10012	1" ID x 1/2" Wall, pack of 35	210'	PK	1
7-S11812	1-1/8" ID x 1/2" Wall, pack of 31	186'	PK	1
7-S12512	1-1/4" ID x 1/2" Wall, pack of 28	168'	PK	1
7-S13812	1-3/8" ID x 1/2" Wall, pack of 25	150'	PK	1
7-S15812	1-5/8" ID x 1/2" Wall, pack of 20	120'	PK	1
7-S11012Y	1-1/2" ID x 1/2" Wall, pack of 17	102'	PK	1
7-S21812	2-1/8" ID x 1/2" Wall, pack of 14	84'	PK	1
7-S0012	2-3/8" ID x 1/2" Wall, pack of 12	72'	PK	1
7-S25812	2-5/8" ID x 1/2" Wall, pack of 10	60'	PK	1
7-S21012	2-7/8" ID x 1/2" Wall, pack of 9	54'	PK	1
7-S31812	3-1/8" ID x 1/2" Wall, pack of 8	48'	PK	1
7-S35812	3-5/8" ID x 1/2" Wall, pack of 6	36'	PK	1
7-S41812Y	4-1/8" ID x 1/2" Wall, pack of 5	30'	PK	1
7-S40012	4-1/2" ID x 1/2" Wall, pack of 4	24'	PK	1

3/4" WALL

CATALOG NO.	DESCRIPTION	TOTAL FEET	UOM	ORDER MULTIPLE
7-S3834	3/8" ID x 3/4" Wall, pack of 25	228'	PK	1
7-S1234	1/2" ID x 3/4" Wall, pack of 35	210'	PK	1
7-S5834	5/8" ID x 3/4" Wall, pack of 30	180'	PK	1
7-S3434	3/4" ID x 3/4" Wall, pack of 27	162'	PK	1
7-S7834	7/8" ID x 3/4" Wall, pack of 25	150'	PK	1
7-S11834	1-1/8" ID x 3/4" Wall, pack of 20	120'	PK	1
7-S13834	1-3/8" ID x 3/4" Wall, pack of 16	96'	PK	1
7-S15834	1-5/8" ID x 3/4" Wall, pack of 14	84'	PK	1
7-S11034	1-1/2" ID x 3/4" Wall, pack of 11	66'	PK	1
7-S21834	2-1/8" ID x 3/4" Wall, pack of 9	54'	PK	1
7-S20034	2-3/8" ID x 3/4" Wall, pack of 9	54'	PK	1
7-S25834	2-5/8" ID x 3/4" Wall, pack of 8	48'	PK	1
7-S21034	2-7/8" ID x 3/4" Wall, pack of 7	42'	PK	1
7-S31834	3-1/8" ID x 3/4" Wall, pack of 6	36'	PK	1
7-S35834	3-5/8" ID x 3/4" Wall, pack of 5	30'	PK	1
7-S41834	4-1/8" ID x 3/4" Wall, pack of 4	24'	PK	1
7-S40034	4-1/2" ID x 3/4" Wall, pack of 4	24'	PK	1

1" WALL

CATALOG NO.	DESCRIPTION	TOTAL FEET	UOM	ORDER MULTIPLE
7-S3810	3/8" ID x 1" Wall, pack of 25	150'	PK	1
7-S1210	1/2" ID x 1" Wall, pack of 21	126'	PK	1
7-S5810	5/8" ID x 1" Wall, pack of 20	120'	PK	1
7-S3410	3/4" ID x 1" Wall, pack of 20	120'	PK	1
7-S7810	7/8" ID x 1" Wall, pack of 16	96'	PK	1
7-S10010	1" ID x 1" Wall, pack of 16	96'	PK	1
7-S11810	1-1/8" ID x 1" Wall, pack of 14	84'	PK	1
7-S13810	1-3/8" ID x 1" Wall, pack of 12	72'	PK	1
7-S15810	1-5/8" ID x 1" Wall, pack of 10	60'	PK	1
7-S11010	1-1/2" ID x 1" Wall, pack of 9	54'	PK	1
7-S21810	2-1/8" ID x 1" Wall, pack of 9	54'	PK	1
7-S20010	2-3/8" ID x 1" Wall, pack of 7	42'	PK	1
7-S25810	2-5/8" ID x 1" Wall, pack of 6	36'	PK	1
7-S21010	2-7/8" ID x 1" Wall, pack of 5	30'	PK	1
7-S31810	3-1/8" ID x 1" Wall, pack of 4	24'	PK	1
7-S35810	3-5/8" ID x 1" Wall, pack of 4	24'	PK	1
7-S41810	4-1/8" ID x 1" Wall, pack of 4	24'	PK	1
7-S40010	4-1/2" ID x 1" Wall, pack of 3	18'	PK	1

DISTRIBUTOR SUPPORT

Literature.....	186
Merchandising.....	187
U.S. General Terms & Conditions	188



LITERATURE

Catalogs

CATALOG NO.	DESCRIPTION	STANDARD PACK
LIT-CAT-HVAC	Issue 24 Catalog	10

Tri-Folds

Each DiversiTech tri-fold brochure has a specific product focus. The tri-folds can be used as counter handouts, or mailed to a contractor. Brochure holders are also available. Most tri-folds are 8-1/2" high by 3-5/8" wide.



Literature Holders

CATALOG NO.	DESCRIPTION	STANDARD PACK
MKT-POP-BROCH	Brochure Holder w/DiversiTech Logo Imprinted	1
MKT-POP-BROCH4	4-Pocket Brochure Holder	1
MKT-POP-EASEL	Acrylic Tri-Fold Brochure Holder	1

CATALOG NO.	DESCRIPTION	STANDARD PACK
LIT-FLY-3D	Triple-D™ Brochure	25
LIT-FLY-3D-S	Triple-D™ Brochure (Spanish)	25
LIT-FLY-BPPPOOL	The Black Pad® Brochure	25
LIT-FLY-CDLC	Condensate Drain Line Cleaners Brochure	25
LIT-FLY-CLAD	CladLite® Pad Brochure	25
LIT-FLY-CLRVUE	ClearVue™ Pump Brochure	25
LIT-FLY-COIL	Coil Cleaning Solution Guide	25
LIT-FLY-COIL-S	Coil Cleaner Solution Guide (Spanish)	25
LIT-FLY-CS1200	CS1200 A/C Shutoff Brochure	25
LIT-FLY-CVMINI	ClearVue™ Mini Pump Brochure	25
LIT-FLY-CVMINI-S	ClearVue™ Mini Pump Brochure (Spanish)	25
LIT-FLY-DISC	Fusible Disconnect Brochure	25
LIT-FLY-DST10	Hard Start Kit Brochure	25
LIT-FLY-DTP3	Three Phase Motor Protector Brochure	25
LIT-FLY-DTP3ES	Three Phase Motor Protector Brochure (Spanish)	25
LIT-FLY-ELITE	E Lite® Pad Brochure	25
LIT-FLY-ET	A/C Easy Tee® Brochure	25
LIT-FLY-FLEX	Flex Inject® Brochure	25
LIT-FLY-FLXHOSEKIT	SpeediChannel™ Flex Hose Kit Flyer	25
LIT-FLY-FLOW	Flow Plus™ Brochure	25
LIT-FLY-FOOT	Hef-T-Foot™ Brochure	25
LIT-FLY-HEAT	Heat Pump Pad™ Brochure	25
LIT-FLY-HPAD	Hurricane Pad Brochure	25
LIT-FLY-HRP	High Rise Pan™ Brochure	25
LIT-FLY-HSI	Universal Hot Surface Igniter Brochure	25
LIT-FLY-MDP	Metal Drain Pan Brochure	25
LIT-FLY-MOTORS	Motor Brochure	25
LIT-FLY-PF	Pro-Flush Brochure	25
LIT-FLY-PF-S	Pro-Flush Brochure (Spanish)	25
LIT-FLY-PUMP	Condensate Pump Line Brochure	25
LIT-FLY-QS	Quick-Sling® Brochure	25
LIT-FLY-RPC	Rapid Positioning Clips Brochure	25
LIT-FLY-RPC-S	Rapid Positioning Clips Brochure (Spanish)	25
LIT-FLY-RSC	Sentry™ Refrigerant Locking Caps Brochure	25
LIT-FLY-SEAL	Cliplight® Brochure	25
LIT-FLY-SPCH18	SpeediChannel™ Brochure and Poster	25
LIT-FLY-SPRAYER	Power Sprayer Brochure	25
LIT-FLY-SPRAYER-S	Power Sprayer Brochure (Spanish)	25
LIT-FLY-SPTEAROFF	SpeediChannel™ Tearpad	25
LIT-FLY-SWITCH	Condensate Switches Brochure	25
LIT-FLY-TRIPBOOST	Triple-D®/Boost Juice® Brochure	25
LIT-FLY-PADS	Pads Brochure	25
LIT-FLY-UC	UltraLite® Pad Brochure	25
LIT-FLY-UCSTRAP	UltraLite® Earthquake Pad Brochure	25
LIT-FLY-UV	Pure-Beam™ UV Light Brochure	25

CATALOG NO.	DESCRIPTION	STANDARD PACK
LIT-FLY-VENTS	Vent Termination Kits Brochure	25
LIT-FLY-WS	Wet Switch® Brochure	25

MERCHANDISING

Posters

CATALOG NO.	DESCRIPTION	STANDARD PACK
MKT-POSTER-CHT24E	Chemical Maintenance Solution Quick Reference Guide - 24" x 36"	1
MKT-POSTER-CHT24S	Chemical Maintenance Solution Quick Reference Guide - 24" x 36" (Spanish)	1
MKT-POSTER-CHT36E	Chemical Maintenance Solution Quick Reference Guide - 36" x 48"	1
MKT-POSTER-CLRVUE	ClearVue™ Pump Poster	1
MKT-POSTER-HPAD	The Hurricane Pad™ poster	1
MKT-BANNER	DiversiTech® Vinyl Banner 2' x 5'	1

P.O.P. Merchandisers/Displays

CATALOG NO.	DESCRIPTION	STANDARD PACK
MKT-MAT-COILTAB	Chemical Maintenance Solution Quick Reference Guide - Mat	1
MKT-MERCH-USACAPS	Merchandising Kit for USA Capacitors	1
MKT-MERCH-CHEM	Chemical Display for Gondola	1
MKT-MERCH-DPWIRE	DP-1 Wire Rack	1
MKT-MERCH-FLEX	Flex-Inject® Counter Display	1
MKT-MERCH-RSC	Sentry™ Wall Display	1
MKT-MERCH-SENTRY	Sentryman Display	1
MKT-MERCH-SWITCHWIRE	Wire Display Rack	1
MKT-POP-CDLC	Condensate Drain Line Cleaner Display	1
MKT-POP-CHEM	DiversiTech® Chemical Display 26" base x 73" height	1
MKT-POP-CLRGOND	ClearVue™ Pump Display for Gondola	1
MKT-POP-CVTUBE	ClearVue™ Tube Display	1
MKT-POP-DEVBACKS	DEVCO® Background Graphics for pegboard	Set of 2
MKT-POP-DEVBACKSSLAT	DEVCO® Background Graphics for Slatwall	1
MKT-POP-DEVCOMBO	DEVCO® Display Rack – Combo	1
MKT-POP-DEVELEC	DEVCO® Display Rack – Electrical	1
MKT-POP-DEVEZC	DEVCO® Display Rack – EZC	1
MKT-POP-DTBACKS	DiversiTech® Background Graphics for pegboard	Set of 2
MKT-POP-DTBACKSSLAT	DiversiTech® Background Graphics for Slatwall	1
MKT-POP-DUCT	SpeediChannel™ Counter Display	1
MKT-POP-DUCTSPIN	SpeediChannel™ Floor Spinner	1
MKT-POP-ET	A/C Easy Tee® Merchandiser	1
MKT-POP-HSI	Merchandiser Display for TrueStar® Hot Surface Igniters	1
MKT-POP-PF	Pro-Flush® Display	1
MKT-POP-QSBACK	Quick-Sling® Display Background	1
MKT-POP-QSMSBOX	Mini-Split Outside Unit Box	1
MKT-POP-QSWIBOX	Unit Heater Box	1
MKT-POP-SWITCHBACK	Background Display for Condensate Switches	1

MKT-POP-QSWIBOX



MKT-MERCH-DPWIRE



MKT-POP-HSI



MKT-POP-PF



MKT-POP-CDLC



MKT-POP-ET



MKT-POP-CHEM



MKT-POP-DEVCOMBO



MKT-POP-DEVELEC



MKT-POP-DEVEZC

U.S. GENERAL TERMS AND CONDITIONS**General Policy****WE ARE COMMITTED TO DO WHAT IT TAKES TO DELIVER WORLD CLASS SERVICE AND PRODUCTS.**

All items not ordered in multiples of standard package quantities will automatically be increased to the next standard package quantity. All purchase orders submitted by our customers are assumed as accepting our general terms and conditions as stated herein, any conflicting terms stated on the purchase order cannot supersede our terms.

Order Discrepancies:

All order discrepancies must be reported to us within 5 working days from the date of delivery. Any discrepancies reported after this period cannot be honored.

Terms:

1% 15 days. Net 30 days. Late charges of 1-1/2% per month will be charged following the due date of the invoice.

Prices:

Subject to change without notice.

Minimum Order:

\$250.00 minimum order on all original orders. Less than pallet quantities are not available for equipment pads.

Freight Policy

CONTINENTAL U.S.: All orders in excess of \$2,000 will ship prepaid. This policy applies to any combination of DiversiTech, Wagner, Specialty Chemical, and Devco products.

Pick Up Allowance

3% of net invoice, 24-hour notice requested. Order must qualify for prepaid freight to receive pick up allowance.

Lost or Damaged Freight

Although we take special care to insure the safe arrival of your merchandise, our responsibility for damages ceases when the customer accepts the shipment. To protect your interest, we suggest that you thoroughly inspect all items before accepting delivery. If your order was damaged in shipment or contains a shortage, report the loss or damage AT ONCE to DiversiTech. Any claims for lost or damaged freight must be noted on the Bill of Lading at the time of delivery. If damage is present, you MUST hold the original carton and merchandise for credit by your Sales Representative – otherwise, no claim can be honored.

Returns:

No merchandise will be accepted for return without prior authorization. Call our Customer Service Department to request permission to return goods. Instructions on method of return will be given to you at that time. All returns are subject to a 25% restocking charge.

Warranty Disclaimer

DiversiTech has made a diligent effort to illustrate and describe the products in this catalog accurately; however, such illustrations and descriptions are for the sole purpose of identification, and do not express or imply a warranty that the products are merchantable or fit for a particular purpose, or that the products will necessarily conform to the illustrations or descriptions. DiversiTech assumes no liability for typographical or photographic errors.

DiversiTech reserves the right to make changes in design, material or finish in an effort to improve our products without special notification. If necessary, DiversiTech reserves the right to replace any product shown in catalog with another comparable product without special notification. All DiversiTech products include a 1 year standard limited warranty unless otherwise noted.

DiversiTech's ULTRALITE®, CLADLITE®, and E LITE® Limited Lifetime Warranty

To the original owner of the ULTRALITE®, CLADLITE®, or E LITE® equipment base, DiversiTech warrants the base to be free of defects in materials and workmanship for the life of the equipment under which it is installed so long as the installing homeowner lives there. All defective merchandise must be returned to the factory, transportation prepaid, and if the same is found to be defective, it will be repaired or replaced free of charge, F.O.B. factory. This warranty does not cover replacement labor cost, or any cost claim incident to the defect, replacement, or reinstallation, nor field repair expenses. This warranty gives you specific legal rights and you may also have other rights which vary from state to state. Some states do not allow the exclusion or limitation of incidental or consequential damages, so the above limitation of exclusion may not apply to you.

Exclusions and Limitations

DiversiTech's ULTRALITE®, CLADLITE®, and E LITE® equipment pads are designed and manufactured to be used as bases for light, ground supported equipment such as air conditioning condensers, swimming pool filters and heat pumps. Use of ULTRALITE®, CLADLITE®, and E LITE® pads for purposes other than those listed above or improper installation of ULTRALITE®, CLADLITE®, and E LITE® pads may result in pad failure. DiversiTech Corporation disclaims any liability due to such misuse or improper installation. If you have questions concerning the proper installation or use of DiversiTech's ULTRALITE®, CLADLITE®, and E LITE® equipment pads, you should contact our Customer Service Department at (800)995-2222.

Made in the U.S.A.

All item numbers in RED indicate Made in the U.S.A. This information was accurate at time of catalog printing. Visit www.diversitech.com to verify country of origin for any DiversiTech product.

CATEGORY INDEX

007 Control Checker.....	127	90 Street EII (MIPT x Slip).....	140	Beam Clamps.....	17
1 Hole EMT Pipe Straps.....	19	90 Street EII (SPIG x Slip).....	139	Bi Flow Driers	178
1 Hole Rigid Pipe Straps - Heavy Duty – Steel	19	A/C Condensate Drain Pan Fittings .	41	Bi-Metal Reciprocating Saw Blades .	128
2 Hole PVC Pipe Straps	19	A/C Easy Tee.....	39	Black Jack Roof Cement	54
2 Hole Rigid Pipe Straps Steel	19	A/C Secondary Condensate Drain Pans	40	Black Nylon Cable Tie Assortment	75
200 Piece Terminal Kit	112	A/C Security Cages	13	Black Nylon Ties with Mounting Hole.	118
25 Year Acrylic Latex Painter's Caulk .	54	Abrasive Cloths.....	44	Black Nylon Wire Ties.....	118
2-in-1 Copper Tube Cleaning Brush.	121	Access Fittings	172	Black Steel Welded Nipples.....	32
3 Pole Switch for Mini-Splits.....	94	Accessories	157	Blade (Auto) Fuses - Devco.....	81
3 Rail Large Mini-Split Stands.....	11	Acid Eliminator	166	Blade (Auto) Fuses - Electrical...	104
3-36® Multi-Purpose Lubricant & Corrosion Inhibitor	49	Acid Test Kits	165	Blind Rivet Tools.....	76
45 Degree EII	32	Adapter (Insert x Slip)	141	Boiler Bracket	9
45 Degree EII C x C	169	Additives	166	Boost Juice & Boost Juice Inject..	166
45 Degree Flat Bend.....	148	Adjustable Delay on Break Time & Make Timer.....	105	Box Cover Units	104
45 Degree Street EII Ftg. x C.....	170	Adjustable Equipment Risers.....	8	Box Handler Gloves	52
45 Elbows	138	Adjustable Flat Bend.....	147	Box Stabilizer Support.....	18
45 EII (Slip x Slip).....	139	Aerosol Starter Kit	157	Box To T-Bar Fastener.....	18
4-Outlet GFCI Power Pack	109	Aerosols	44	Boxes, Rings, and Covers.....	72
4-Piece Hook and Pick Set	126	Air Conditioner Brackets.....	10	BP-46 Boiler Pump	36
5-Outlet GFCI Shock Buster	109	Air Handler Base - Heavy Duty Adjustable	12	Braided Clear Vinyl Tubing.....	42
6180 Series Terminal Blocks	84	Air Handler Blocks	8	Brass Adapters.....	172
6190 Series Terminal Blocks	85	All Purpose Cleaning Pads	44	Brass Fittings.....	174
7 Mil Commercial & Professional Grade Electrical Tape	110	All Purpose Sprayers.....	160	Bridle Rings.....	18
8.5 Mil Commercial Grade Electrical Tape.....	110	All Weather PVC Cement.....	136	Brushes.....	121
90 Degree EII	32	All-Purpose Clear Cement for ABS, PVC and CPVC Pipe and Fittings.	136	Bubble-N-Trouble™ Freeze Protected Spray-On Leak Detector	161
90 Degree EII C x C	169	Aluminum Armored MC Cable	96	Bushing	33
90 Degree Flat Bend.....	147	Aluminum Dryer Vent Hoods, Kits, and Fittings	23	Bushing (MIPT x FIPT)	134
90 Degree Inside Elbow.....	148	Aluminum Equipment Stands.....	11	Bushings and Locknuts.....	76
90 Degree Long Radius Bend....	148	Aluminum Foil Tape	25	Butt Connector Assortment Kit....	67
90 Degree Long Turn EII C x C...	170	Aluminum Solderless Lugs	86	BX 1 Hole Strap	19
90 Degree Long Turn Street EII Ftg. x C	169	Anchor Kit	55	BX and Greenfield Connectors ...	74
90 Degree Outside Elbow	148	Anchors	70	BX Set Screw Connectors	96
90 Degree Street EII	33	Anti-Vibration Pads	6	Cable Clamp Pro	123
90 Degree Street EII Ftg. x C.....	169	Armored Connector	83	Cable Connectors.....	73
90 Elbow (Hub x Hub)	138	Armored Plug	82	Cable Markers	86
90 EII (Slip x FIPT)	139	Aviation Snips.....	129	Cable Staples.....	96
90 EII (Slip x Slip).....	139	Base Pad.....	8	Cable Tie Assortment Pack	117
90 EII Reducing (Slip x FIPT)	139	Batteries by Rayovac.....	45	Cable Tie Channel Clips.....	15
				Cable Tie Mounts.....	75
				Cable Ties and Accessories	74
				Canvas Drop Cloths.....	47
				Cap (FIPT).....	141

CATEGORY INDEX cont'd

Cap (Slip)	140	Compression Sprayers	160	CS-3 Condensate Pan Switches ..	37
Capacitors.....	97	Compression Tee	174	Curve Light.....	125
Carabiners	130	Compression Union	174	Cushion Clamps - Mounting Systems.	15
Carbon Monoxide & Smoke Alarms.	31	Compressor Lead Kit.....	65	Cushion Clamps - Inline Components 176
Carbon Steel Curved Handle Scratch 122	Compressor Repair Kit	111	Cut Resistant Gloves.....	50
Brush	122	Compressor TOTE.....	126	Cutting Oil.....	49
Carton Sealing Tape and Dispenser.	45	Concentric Vents	29	D'Scale Acid Scale Remover	165
Carton Tape Dispenser	45	Condensate Cop™	37	Degreasers.....	46
Catalogs	186	Condensate Drain Line Cleaning .	39	Deluxe Digital Pocket Thermometer 131
Caulk Gun.....	54	Condensate Drain Line Switches .	37	Deluxe Hi-Tension Hacksaw.....	128
CBC II Contact Cleaner	44	Condensate Drain Pans, Fittings, 40	Devco Crimpers.....	76
Channel Nuts	16	Adapters	40	Devco Plastic Anchor Kits.....	71
Channel Post Base for 1-5/8" Strut 16	Condensate Neutralizers.....	37	Devco Racks Master Item List.....	62
Channels	16	Condensate Pumps	36	Devco Terminal Kits.....	69
Channellock® Products	122	Condenser/Heat Exchanger Brushes 122	Device Rings	72
Chip Brushes.....	121	122	Dial-a-Mix Sprayer	160
Chlor-Free Degreaser.....	46	Conduit Fittings & Nipples	75	Digital Single Phase Line Voltage 105
Citrus Degreaser.....	46	Conduit, Fittings, Cable	95	Monitor	105
CladLite® Lightweight Concrete 3	Connection Plates for 1-5/8" Strut 16	Digital Thermometer	131
Equipment Pads	3	Channels	16	Digital Three Phase Line Voltage 105
Clean Out Tee.....	141	Contact Cleaners.....	46	Monitor	105
Clear Cleaner	136	Contactors	100	Direct Replacement Igniters	28
Clear Vinyl Tubing	41	Cool-Weld Heat Barrier Spray	157	Disconnects - Metal Case & 94
ClearVue™ Pump	36	Cop-Cap™ Locking Valve Cover ..	172	Non-Metallic Case	94
ClearVue™ Tube & Traps	38	Copper Coupling with Dimple Stop 171	DiversiGum Sealing Compound ..	54
ClearVue™ Mini Ductless System 36	& with No Stop.....	171	Diversitech Electrical Disconnects .	94
Pump.....	36	Copper Fittings.....	169	Diversitech Gas Connectors	30
Cliplight Extends.....	125	Copper Saddle Valve.....	173	Diversitech Hard Start Kits	100
Clip-On Zoom Light.....	125	Copper Tube Fitting Brushes.....	122	Diversitech Line Sets.....	179
Clips	81	Core Removal Tool	173	Diversitech Motors Brackets	93
Clipstrip™ Aqua.....	124	Core Storer.....	173	Diversitech Refrigerant ID Labels .	182
Clipstrip™	124	Cork Insulation Tape	42	Diversitech Tear-Resistant Line Sets.	180
Clipstrip 2™	124	Cotter Pins	79	Diversitech Tear-Resistant Mini-Split 181
Cloth Duct Tape	26	Coupling - Heating Products	33	Line Sets	181
CO ₂ Cylinders	120	Coupling (Slip x Slip).....	140	DiversiTech 2 & 3 Pole Definite 100
Coil Cleaners.....	156	Coupling (Socket) with Rolled Tube 170	Purpose Contactors	100
Coil Guard.....	157	Stop C X C.....	170	DiversiTite Flexible Conduit	95
Combination Packs.....	65	Couplings (Hub x Hub)	138	DiversiWhips	93
Combination Screwdrivers	128	Coveralls	46	DiversiWhips for the Swimming Pool 94
Combo Head Sheet Metal Screws.	78	CP-22 Pumps	36	Industry.....	94
Compartmented Storage Boxes .	111	CPVC-CTS Pipe and Fittings.....	134	DiversiWhips Pallet Packs.....	93
Compression Connector	174	Cross Reference	114		
Compression Elbow, Nut, Sleeve .	174	CS1200 AC Shutoff Switch	37		

DiversiWhips with Extended Length Wires	93	Eco-Coil™ Environmentally Friendly Coil Cleaner	156	Finished Hex Nuts.....	77
Dormont 20 & 30 Series.....	31	Economy Electrical Tape	111	Firestop Products for Class A Buildings	54
Dormont Gas Connectors and Valves	31	EcoPad™ Black Plastic Equipment Pads.....	5	First Aid Kits.....	52
Drain Line, Tubing	41	Egg Crate Louvers - Air Return Diffusers.....	22	Fitting Reducer Coupling Ftg. x C .	170
Drain Pan Disinfectant	158	Elbow (Barb x Barb).....	135	Fittings.....	147
Drain Trap Kits	38	Electrical Duplex Receptacles ...	106	Flag Female Compressor Terminal ..	65
DrainDawg™ and DrainKat™ Fittings.....	39	Electrical Outlet Boxes, Extensions and Covers.....	106	Flange Mount Conduit Assembly (bottom & side mount).....	17
DrainGun™ and Cartridges	39	Electrical Staples.....	76	Flare Tee.....	175
DrainKat™	39	Electrical Supplies	123	Flare Union	175
Driers, Sight Glasses	177	Electrical Tapes.....	110	Flare x FIP Union.....	176
Drive Fasteners.....	70	Electrical Toggle Switches	106	Flare x Flare Swivel Union	176
Drop Cloths	47	Electrolytic Copper Solderless Lugs.....	86	Flare x MIP Elbow	174
Drop-In Expansion Anchors & Setting Tool	70	Electronic Degreaser	46	Flare x MIP Reducing Elbow	174
Dry R™.....	166	EMT (Thinwall) Fittings.....	96	Flare x MIP Union	175
Dryer Cords	108	EMT Strut Clamp.....	16	Flash Detect UV Leak Detection Kit ..	161
Dryer Duct, Vent Hose, Hose Clamps ..	23	Equipment Stands	11	Flat Surface Adapter	15
Dual Element Fuses - 250V.....	81	EVA Anti-Vibration Pad	6	Flat Wall Escutcheon	149
Dual Element Fuses - 250V.....	103	Evergreen CM ECM Motors.....	90	Flat Washers	77
Duct Cleaning Brush.....	121	Evergreen EM ECM Motors	90	Flex Duct Tape	25
Duct End.....	149	Evergreen IM ECM Motors	90	Flex Inject® Sealant Advanced & Total.....	162
Duct Fans.....	22	Evergreen InTune Motors.....	91	Flex Joint	149
Duct Strap, Ties, Clamps	24	Evergreen OM ECM Motors.....	91	Flex Light.....	125
Duct-Fresh Gel & Spray.....	163	Evergreen PF ECM Motors	91	Flexible Refrigerant Line.....	182
Ductless Cassette Hangers.....	10	Extended Lengths for Concentric Vents	29	Flexi-Patch™	53
Dust Masks	52	Extension Rings	72	Flow Plus® Condensate Pan Treatment.....	164
DWV Bend Fittings, Bushings, Vent Tee.....	138	Fan Centers.....	103	Flue Caps.....	22
E Lite® Plastic Equipment Pads.....	3	Fasco® OEM Replacement Draft Inducers.....	92	Flushing Products	159
EasyFlex® Tankless Water Heater Connection Kits	30	Fast Cure Epoxy.....	53	Foam Insulation Tape.....	42
EasyGuard™	151	Fast Orange Hand Cleaner.....	47	Foam Sealant - One Component.....	53
EasyID Blade Fuses	104	Felt Tip Markers	50	Foam-Plus™ Aerosol Foaming Coil Cleaner.....	158
Eaton Circuit Breakers - Type BR & Type CH	107	Female Adapter (Barb x FIPT)	134	Foil Scrim Kraft Tape	25
Eaton Contactor Accessories	101	Female Adapter (Slip x FIPT).....	140	FP-22 Furnace Pump	36
Eaton Definite Purpose Contactors ..	101	Female Adapter C x F.....	169	Fully Insulated Dead End Connectors	66
Eaton Electrical Disconnects	95	Female Adapter Elbow (Barb x FIPT)	135	Fully Insulated Female Slip-Ons...	64
Eaton Switch A/C Disconnect	95	Female Adapter Reducing (Slip x FIPT)	140	Fully Insulated Flag Female Slip-Ons	64
Eaton Three Phase Disconnects ..	95	Fender Washers	78		
		Fin Whisk	122		

CATEGORY INDEX cont'd

Fully Insulated Male Slip-Ons	64	Heat Resistant Cloth	132	Horizontal Vent Termination Kits...	29
Fully Insulated Receptacles	65	Heat Shrink Tubing - 50% Polyolefin	112	Hose Clamps - Devoc	79
Furnace Mounting Blocks.....	8	Heat Shrink Tubing Assortments...	85	Hose Clamps - Plumbing	142
Furnace Pans	40	Heating Equipment Service Products	28	Hose Mender (Barb x Barb).....	135
Fuse Adapters, Blocks, Pullers....	104	Heavy Duty Cable Ties.....	24	Hoses, Sprayers	160
Fuse Holders	84	Heavy Duty Cable Ties.....	117	Hot Water Hose	160
Fuses	103	Heavy Duty Degreaser	46	HVAC Mini-split wiring solutions	115
Fusible Links	113	Heavy Duty High Rise Pans.....	40	HVAC Tools	129
Garden Hose	160	Heavy Duty Nylon Cable Ties.....	74	Hydrogauge Manometer	126
Garden Hose Adapters	134	Heavy Duty PVC Cement	136	Ice Machine Products	161
Gas Ball Valve	31	Heavy Duty Silicone Mold Release..	49	Icemaker Kit	142
Gas Equipment Service Tools	28	Heavy Duty Tri-Tap Extension Cord -		Indicator Lights.....	85
Gas Pressure Test Kit.....	126	3 Outlets	108	Industrial Enamel	50
Gauges	120	Heavy Duty Work Gloves	51	Industrial Towels	47
Gauges	125	Hef-T-Block™	8	In-Line Fuse Holder.....	104
General Purpose Pumps	36	Hef-T-Brackets™	9	In-Line Tri-Tap Portable GFCI	109
General Purpose Relays.....	102	Hef-T-Foot™	9	Insta-Charge.....	178
General Purpose Spray Paint.....	50	HEMImini™	125	Insta-Tap Refrigerant Recovery Tool..	173
General Purpose Switching Relays.	102	HEMIPLUS™2	125	Insulated Butt Connectors	66
General Purpose Vinyl Electrical Tape	110	Hex Head Cap Screws.....	77	Insulated Female Slip-Ons	64
General Tools	76	HF™ Contact Cleaner	45	Insulated Hooks.....	66
Generator Power Cord Sets	108	H-Frame Kits.....	16	Insulated Male Slip-Ons	64
Glass Cleaner.....	44	High Heat Spray Paint	50	Insulated Plugs.....	65
Glass Cloth, Moisture, Sealing &		High Rise Pans	40	Insulated Rings, Spades, Spring	
Economy Electrical Tape	111	High Temp Red Silicone Sealant ..	54	Spades	67
Glycols.....	158	High Temperature Assortment.....	68	InsulClips	15
Gorilla Tube Clear Vinyl Tubing.....	42	High Temperature Butt Connectors..	68	Iso-Cube Economy Anti-Vibration Pad ..	6
Grease Fittings	80	High Temperature Female Slip-Ons..	68	J Hooks.....	18
Grip-Cut	44	High Temperature Flag Female		Jackson Safety G40 Foam Nitrile &	
Grommets - Vinyl.....	112	Slip-Ons	68	Latex Coated Gloves	52
Ground Adapter	83	High Temperature Male Slip-Ons..	68	Jackson Safety V30 Nemesis Safety	
Ground Fitting Clamp.....	86	High Temperature Range Wire	82	Glasses.....	52
Grounding Rubber Handle Plug...82		High Temperature Rings	68	J-B Weld	53
Hand Cleaners	47	High Temperature Solderless Terminals		J-Hooks.....	18
Hand Warmer	52	68	Kimberly-Clark® Waterless Hand	
Hanging Brackets	13	High Temperature Spades	68	Wipes	47
Hanging Strap	130	High Temperature Wire.....	116	Kimtex® Shop Towels.....	47
Hanging Wire	24	Hooks, Springs and Fixture Support..	18	KleenGuard®	46
Hard Start Kits	100	Horizontal Air Handler Stand	12	Knock'er Loose® Penetrating Solvent.	48
Heat Pump Pad	6	Horizontal Refrigerator/Freezer		Knockout Seals and Hole Plug.....	75
Heat Pump Risers	8	Analog Thermometer	131	Kut-All Plastic Tube and Hose Cutter	
Heat Pump Stand	11			132
				Large Mini-Split Stands	11

Lashing Strap	129	Metal Drain Pan.....	41	Nylon Cable Clamps	79
Latex Gloves.....	51	Metal Drive Anchors.....	70	Nylon Cable Ties.....	75
Leak Detectors and Accessories .	161	Metal Guard Trouble Lights.....	123	Nylon Cable Ties with Mounting Hole	74
Leak Sealants.....	162	Metal Parts Boxes	80	Nylon Fittings	134
Leak Test Gauge	131	Metallic Duct - 2 Ply	24	Oatey® Products	136
Leather Work Gloves.....	51	Metallic Duct - 5 Ply	23	Odor Neutralizers	163
Line Piercing Valves and Tools ...	173	Mini-Split Condensate Drain Line	41	Offset Snips.....	129
LineSet Box	179	Mini-Split Double Stack Stand	11	One Piece Heat Pump Risers.....	8
LineSet Cutting Tools.....	150	Mini-Split Drain Adapters.....	41	One Time Fuses.....	103
Liquid Line Driers.....	177	Mini-Split Dual Fan Stands	11	One-Handed PVC/Hose Cutter ...	132
Liquid Tite Connectors.....	95	Mini-Split Pumps	37	Outdoor Extension Cord	123
Liquid-Tite Connectors	74	Mini-Split Stands	10	P.O.P. Merchandisers / Displays .	185
Literature.....	186	Mini-Split Super Stand	11	Pads	1
Louvered Dryer Vent Hood	23	Miscellaneous Tools.....	126	Paints and Primers	50
Low Profile Disconnects - Metal Case .	94	Molded Case Switch Disconnect .	94	Pan Treatments/Disinfectants.....	164
Lubricants	48	Monitors - Electrical.....	105	Pan-Kote Heavy Duty Drain Pan Patch	158
LuxPro Thermostats.....	113	Monitors - Tools	127	Pan-Patch.....	158
Machine Screw Hex Nuts	77	Motor Brackers	93	Parts Cleaning Brush	121
MAC-The Ultimate in Line Piercing		Motor Mount - Flex Bracket.....	93	Patriot Pocket Worklight	162
Valves	173	Motor Run Capacitors - 370VAC ..	97	Periscope Connection Kit	24
Made in the U.S.A. Capacitors Oval		Motor Run Capacitors - 440VAC ..	98	Pigtails.....	86
& Round Metal Can	99	Motor Run Capacitors (USA made) ..	99	Pipe Hanging Strap.....	79
Magjumper	130	Motor Run Capacitors (USA made) ..	99	Pistol Grips & Water Nozzle.....	160
Magnetic Hex Chucks	76	Motor Shaft Key Assortments.....	79	Pitched Roof Mini-Split Mounting	
Male Adapter (Barb x MIPT).....	134	Motor Start Capacitors (110/125		Bracket.....	10
Male Adapter (MIPT x Slip)	140	VAC, 220/250 VAC, 330 VAC).....	99	Pivot™	124
Male Adapter C x M	169	Motors	88	Pivot™ 33.....	124
Male Adapter Elbow (Barb x MIPT) .	135	Mounting Accessories.....	13	Pivot™ Mini.....	124
Male Adapter Reducing (MIPT x Slip)		Mounting Blocks.....	8	Pivot™ Tough-Light.....	124
.....	141	Mounting Brackets.....	9	Plan-O-Gram for Devco Combo Rack	61
Malleable Black Iron Pipe Fittings .	32	Mounting Straps	19	Plan-O-Gram for Devco Elec Rack.	59
Manifold Gauges	125	Multi Color Test Leads	130	Plan-O-Gram for Devco Ezc Rack.	60
Manometers, Pressure and Test Kits		Nitrile Gloves.....	51	Plastic DWV J-Hooks.....	142
.....	126	Nitrogen Cylinders	120	Plastic Hanger Strap	24
Manual Reset Fire Stat.....	113	Nitrogen Purge Tool	120	Plastic Thermostat Guards.....	114
Map-Pro and Propane Gas	132	Non-Insulated Female Slip-Ons ...	64	Plastic Wall Plates	106
Markers.....	50	Non-Insulated Flag Female Slip-Ons		Plastic White End Caps	17
Masonry Bit.....	55	64	Plastic Wide Mouth Dryer Vent Hood	23
Masonry Screw.....	55	Non-Insulated Male Slip-Ons.....	64	Plated Steel Utility Covers	72
Medium Orange CPVC Cement .	136	Non-Insulated Rings	67		
Medium Split Lock Washers	77	Non-Insulated Spades.....	67		
Merchandising	185	Non-Metallic Sheathed Cable			
Metal Bat Handle Toggle Switches .	84	(Romex Wire)	96		
		Nuts and Bolts.....	77		

CATEGORY INDEX cont'd

Plenum Duct Strap - UL rated 24	Pro-Red Plus™ 157	Quick-Sling® Air Handler Hanging Bracket..... 13
Plenum Thermostat Wire 114	ProTek™ BG for Cast Iron Water Boilers 159	Quick-Sling® Accessories - Steel & Wood Beam Adapters 14
Plenum-Rated Condensate Switches 38	ProTek™ Closed Loop Heat Transfer Fluid 159	Quick-Tap 173
Plenum-Rated Low-Profile CP-22 Pump 36	ProTek EG™ 158	Radiant Leak Finder 161
Plug - Heating Products 33	ProTek PG 100™ 159	Rain-R-Shine Blue Cement 136
Plug - Inline Components..... 175	ProTek PG Plus™ 159	Range Cords 108
Plug (MIPT) 140	Pro-Thaw™ Liquid Dryer for Refrigerants..... 166	Rapid Positioning Clips 14
Plug (Slip)..... 140	PRO-TITE™ Resin Based Thread Sealant 166	Ratchet Strap 130
Plug Fuses 104	Pro-Treat® 164	Rayovac® Lantern Batteries 45
Pocket 4-in-1 Mini Screwdriver .. 128	Pro-Treat® 350 Condensate Drain Pan Treatment 164	Rayovac® Industrial Maximum Alkaline Batterie (Shrink & Contractor Packs) 45
Polyethylene Tubing 142	Pro-Treat® Pan Strips..... 164	Receptacles 83
Polypropylene Parts Boxes..... 80	Pro-Weld™ PVC Cement 137	Reducer Bushing (SPIG X FIPT).. 141
Polyvinyl Chloride, White PVC 1120. 138	Pro-Weld™ Weather - ALL..... 137	Reducer Bushing (SPIG x Slip) .. 141
Porcelain Outlet Box Lampholders . 84	Pro-Yellow™ 157	Reducer Coupling - Ductless Systems 149
Porcelain Wire Connectors 86	PTFE Tape..... 42	Reducer Coupling w/Stop C x C. 170
Porcelain Wire Connectors 117	P-Traps..... 171	Reducing Coupling - Heating Products..... 33
Portable Hand Torch..... 132	Pull-A-Spout Oiler 49	Reducing Tee..... 33
Posters..... 185	Pump Parts & Accessories 37	Reducing Washers..... 75
Potential Relays..... 102	Pure-Beam™ Ultraviolet Light 23	Refractometer..... 127
Powder Free Unlined Nitrile Disposable Gloves..... 51	Purple Primer for PVC Pipe and Fittings..... 136	Refrigerant Charging..... 178
Power Blocks 123	PVC Cement - Clear..... 136	Refrigerant Labels..... 182
Power Cords and Work Lights 78	PVC Condensate Pipe 138	Refrigerant Recovery Cylinders & Products..... 183
Power Sprayer 160	PVC DWV Fittings..... 138	Refrigerant Tubing..... 179
Power Supply Cords (Pigtails).... 108	PVC Gray Cement for High Efficiency Furnaces, Vent and Make-Up Air 136	Refrigeration Oils..... 165
Power Supply Replacement Cords . 83	PVC Primer - Clear..... 136	Refrigerator Coil Brush..... 121
Pro-Air Duct Sealant – UL 181 AM-BM Listed 54	PVC Primer and Cement 137	Refrigerator/Freezer Analog Thermometer..... 131
Pro-Air Industrial Grade Spray Adhesive 54	PVC Schedule 40 Pressure Fittings 139	Regulators..... 120
Pro-Blue™ 156	QD® Contact Cleaner..... 45	Rehvac Nitrogen Purging Equipment 120
Pro-Brown™ 156	Quick Swivel "U" Mount - Unit Heater Bracket..... 13	Rehvac Refillable Gas Cylinders 120
Pro-Bubble™ Leak Detector..... 161	Quick Swivel Flush Mount w/"H" Bracket - Unit Heater Bracket..... 13	Relays..... 102
Pro-Flush® HVAC Flushing Solvent. 159	Quick Swivel Flush Mount w/"I" Bracket - Unit Heater Bracket..... 13	Replacement Compressor Leads.. 111
Pro-Green™ 156		Replacement Element Kits 113
Pro-Kleen™ 157		Replacement Power Supply Cord . 108
Pro-Lube™ Mineral Oil 165		
Pro-Lube-POE Polyolester 165		
Pro-Lube-VAC™ Vacuum Pump Oil.. 166		
Pro-Prime™ Clear PVC Primer 137		
Pro-Prime™ PVC Primer (Purple) 137		

Right Angle GFCI Plug - Field Wired 109	Self-Sealing Split Tubing Insulation .184	Standard Wire Connectors 86
Right Angle Plug 83	Semi-Rigid Aluminum Duct 23	Staples and Staple Guns..... 126
Right Angle Tri-Tap Portable GFCI.. 108	Sentry Refrigerant Locking Caps . 168	Sta-Plex™ Premium Red Grease... 49
Rigid Conduit Bodies 73	Sentry Universal Key for Refrigerant Locking Cap 168	Steel 1900 Boxes 72
Rigid Strut Clamp 15	Sequencers..... 113	Steel 1900 Covers 73
Romex Connectors - Metallic..... 96	Set Screws 79	Steel Thermostat Guards 114
Roof Bracket 13	Sheet Metal Screw Assortments... 78	Steel Utility Boxes 72
Roof Flashing 22	Sheet Metal Screws 55	Stick-E-Tape..... 25
Roof Inlets 150	Shoe Covers 51	Sting Less Wasp & Hornet Killer .. 56
Roof Louver 22	Shop Towels 48	Storage Containers 80
Round Extension Cords 78	Short Forged Flare Nut 175	Stove Bolts 77
Rubber / Cork Anti-Vibration Pad... 6	Short Nut 175	Stranded Copper THHN Wire..... 114
Rubber Connector 83	ShuBee® Dark Blue Shoe Covers . 51	Stranded Copper Wire in Clear Dispenser Pack, 194°F 115
Rubber Tie Down Strap..... 130	ShuBee® Surface Liner..... 56	Stranded Copper Wire on Spool . 115
Safety Plates 73	ShuBee® Trishield Coverall 46	Stranded High Temperature Wire . 82
Safety Supplies, Devices 50	ShuBee® Black Gauntlet® Silver Edition Nitrile Disposable Gloves. 51	Strapping Hanger Iron..... 24
Saf-N-Kleen™ Aerosol Solvent Coil Cleaner 158	Sight Glasses 178	Straps 75
Sani C-N-D™ Coil and Drain Pan Disinfectant..... 158	Silicone Sealant 54	Straps, Truck Rope..... 129
Satchel Style Case..... 80	Single Piece Liquid Tite Fittings ... 95	Strut Clips & Clamps 14
Saws and Saw Blades..... 128	Single Portable GFCI Adapter..... 109	Strut, Threaded Rod and Accessories 16
Scotch® 35 Vinyl Electrical Tape 110	SJTO Service Cord 82	Studded Clips..... 14
Scotch® 3M Super 33+ Electrical Tape 110	Slip-On Solderless Terminals 64	Suction Line Driers 177
Scotch® 3M Super 88 Electrical Tape 110	Smokeys 22	Super Change™ 159
Screwdrivers, Driver Sets 128	Snips, Notchers, Crimpers, Seamers 129	Super Glue..... 53
Screwloose Industrial Penetrating Oil 48	Soffit Fitting 147	Super Seal™ Sealant Advanced . 162
Screws 78	SP-400 Corrosion Inhibitor..... 49	Super Seal™ Sealant Sure Shot 163
Sealant, Epoxy, Glue 53	Special Purpose Solderless Terminals 65	Super Seal™ Sealant Total 162
Sealing Compounds, Adhesive 53	Specialty Fasteners..... 79	SuperComb..... 124
Seal-N-Go® Self-Sealing Refrigerant 162	Specialty Fittings 80	Super-Kool™ Nickel-Safe & Metal
SeekerMax™ 162	SpeediChannel™..... 147	Safe Ice Machine Cleaner..... 161
SeekerMini™ 161	SpeediChannel™ Accessories 150	Supports 142
Self Tapping Water Valve 142	SpeediChannel Line Set Cover System..... 147	Sure-Stick Heavy Duty Adhesive Spray 44
Self-Drilling Gypsum Wallboard Anchors 70	Split Bolt Connectors 86	Surface Protection 56
Self-Drilling Screw Repair Kit 78	Spotlight 125	Surge Protectors 106
Self-Drilling Screws..... 78	Spring Fittings & Beam Clamps... 17	Surge-Trap Type 1 STXH, STXR.... 106
	Spring Steel Beam Clamps..... 17	Sweat-Free Pipe Insulation Spray.. 44
	Spring Steel Cable Clip 17	Switch Covers..... 107
	Standard Solderless Terminals..... 66	Switch/Plug Combo 107
		Swivel Head Deburring Tool..... 132
		Swoosh Gun™ & Cartridges..... 39

CATEGORY INDEX cont'd

System Cleaners.....	165	THHN Stranded Hook-Up Wire.....	81	UltraLite® Lightweight Concrete	
T-50 Series Staples and Staple Guns		Thinwall E.M.T. Connectors.....	74	Equipment Pads	2
.....	126	Thread Sealant with PTFE.....	53	UltraLite® Wedge Pads	2
Tab Adapters	66	Thread Sealants	166	Union - Heating Products	33
Tandem Grounding Rubber Handle.	82	Time Delay Fuses	103	Union Coupling	148
Tankless Water Heater Connection		Time Delay Plug Fuses.....	103	Universal Alarm	38
Kits	30	Time Delays	105	Universal Pump Elbow	150
Tap Connectors	66	Tin Handle Acid Brushes	121	Universal Silicon Carbide Igniters .	28
Tape - Heating Products	34	T-Joint.....	148	Universal Spun Copper Driers....	177
Tape - Devco	80	Toggle Bolts.....	77	Universal Strut Clamp	15
Tapes - Condensate Management .	42	Toggle Switch and Receptacle		UN-Purple Primer.....	137
Tapes - Air Movement.....	25	Combo Device.....	83	Upright Snips.....	129
Tattle-Tale Control Monitor.....	127	Toggle Switch Cover	108	Utility Covers	72
T-Bar Scissor Clips	18	Toggle Switch with Neon Pilot Light		Utility Fuse Outlets.....	84
Tee.....	33	Combo Device.....	84	Utility Plates	72
Tee (Barb x Barb x Barb)	135	Toggle Switches - Devco	84	U-Type Strap.....	171
Tee (Slip x FIPT x Slip)	139	Toggle Switches - Electrical.....	108	UV Pocket Light	162
Tee (Slip x Slip x Slip)	139	Tongue and Groove Pliers	122	Vacuum Pump Oil	166
Tee C x C x C.....	171	Torque Plus - Hard Start Kits	100	Valve Action Marker	50
Teflon Tape	80	Transformers	102	Valve Action Paint Marker.....	50
Teri® Reinforced Towels.....	47	Transparent Plastic Boxes with		Vent Termination Kits.....	29
Terminals, Connectors.....	111	Terminal Assortments.....	111	Ventilation Products.....	22
Terry Towels	48	Traps	139	Versa Cap Flue and Hot Stack	22
Test Cord (Female)	131	Tri-Fold Brochures	186	Vertical Air Handler Stand	12
Test Kits.....	165	Triple Outlets	83	Vibration Isolation Strips for	
Test Leads - Devco.....	81	Triple-D® Universal Coil Cleaner	156	Mini-Split & VRF/VRV12	12
Test Leads	130	Trouble Lights	78	Vinyl Grommet Assortment Packs .	85
Testers	131	Truck Rope	129	VRF/VRV SuperStand.....	12
Testers, Leads, Clips, Fuses.....	81	Truestart Hot Surface Igniters	28	Wagner® Adhesive Sealant	53
TFFN Stranded Hook-Up Wire.....	81	Truestart Flame Sensors.....	29	Wagner® Direct Drive Furnace	
The Black Pad® Black Plastic		Truestart Ignition Accessories	29	Blower Motors	89
Equipment Pads	5	Tube Working Tools	132	Wagner® High Temperature	
The Hurricane™ Pad Concrete		Tubing Insulation	183	Condenser Fan Motors.....	88
Equipment Pads	4	Tubing, Clamps, and Kits	142	Wagner® High Temperature Multiple	
The Hurricane Pad™ Tie Down Clips .	5	Twist-On Wire Connectors	117	Horsepower Condenser Fan Motors	
The Purifier™.....	163	Two Piece Heat Pump Risers	8	89
Thermal Controls.....	113	Two-Piece Liquid Tite Fittings.....	96	Wagner® Multiple Horsepower	
Thermometers/Probes.....	131	Type "S" Non-Tamper Fuses.....	104	Condenser Fan Motors.....	88
Thermoplastic Handle Plug	82	UL Certified Universal Circuit Breaker		Wagner® Multiple Horsepower	
Thermostat Guards	114	107	Furnace Blower Motors	89
Thermostat Wire - Devco.....	82	UL Listed Foil Tape	26	Wagner® Single Speed Condenser	
Thermostat Wire - Electrical	114	UltraLite® 3-36® Ultra Thin		Fan Motors.....	88
Thermostats	113	Non-Staining Lubricant	48		

Wagner® High Temperature Multiple Horsepower Condenser Fan Motors	89	Yellow Epoxy Coated Gas Connectors	30
Wall Bracket Siding	10	Yellow PTFE Thread Seal Tape	34
Wall Brackets (Flat Wall, Siding, Foundation Mount)	9	Yellow PTFE Thread Seal Tape	42
Wall Escutcheon	149	Z Purlin Hanger	17
Wall Penetration	147	Zinc Plated DC Steel Romex Connectors	73
Wasp & Hornet Killer by Enforcer	56	Zinc-It® Instant Cold Galvanize	49
Wasp, Hornet, and Yellow Jacket Killers	56		
Water Heater Pans	41		
WD-40®	49		
Weatherproof Box with Lever Switch Cover	73		
Weatherproof Boxes & Covers	73		
WeatherShield	13		
Welder's Brush	121		
Welding Torches, Supplies	132		
Wet Switch® Flood Detector	37		
Whips	93		
White Lithium Grease	48		
White Nylon Ties with Mounting Hole	118		
White Nylon Wire Ties	118		
White Pipe	182		
Wind Baffles	13		
Winged Wire Connectors	85		
Wire	81		
Wire and Cable Clamps - Nylon	118		
Wire Connectors	116		
Wire Connectors-Contractor	117		
Wire for Mini-Split Installation	114		
Wire Tie Mounts	118		
Wire/Cable Ties, Mounts, Clamps	117		
Wiring Devices	82		
Wolverine® Universal Hot Surface Igniter	28		
Worklights by Cliplight®	124		
WypAll Plus Towels	47		
WypAll ShopPro X80 Towels	47		
WypAll X70 Cloths	48		

PART NUMBER INDEX

01714 53	14250 22	17545 16	189-227220 99	230-14-7 114
01724 53	14340 22	17546 16	189-227330 99	230-18-4 114
02033 183	145-175 99	17547 16	19400 19	230-AFB3 147
02053 183	145-175220 99	17616 16	19401 19	230-AFB3W 147
02100 183	145-175330 99	17618 16	19402 19	230-AFB4 147
02255 183	161-193 99	17626 16	19426 19	230-AFB4W 147
04022 182	161-193220 99	17628 16	19436 19	230-B2L 9
04044 182	161-193330 99	17630 16	19437 19	230-B2M 9
04099 182	1636-3 3	17632 16	19438 19	230-BP17W 8
04134 182	16491 54	17633 16	19439 19	230-CP3 148
04137 182	16500 132	17634 16	19440 19	230-CP3B 148
04402 182	16510 132	17636 16	19441 19	230-CP3W 148
04407 182	16520 132	17638 16	19443 19	230-CP4 148
04410 182	170AIR 163	17682 17	19444 19	230-CP4B 148
04421 182	170AIRFAN 163	17684 17	19445 19	230-CP4W 148
04850 182	170AIRPCB 163	18016 17	19446 19	230-CP6 148
1000-1200 99	171AIR 163	18018 17	19463 19	230-CP6W 148
1002 160	17412 16	18026 17	19490 19	230-CUTTER 150
108-130 99	17420 16	18050 17	19492 19	230-D3A 147
108-130220 99	17430 16	18052 18	19494 19	230-D3B 147
108-130330 99	17438 16	18054 18	19496 19	230-D3W 147
10816 112	17442 16	18056 18	19498 19	230-D4A 147
111110 162	17450 16	18058 18	19500 19	230-D4B 147
111110A 162	17452 16	18060 18	19501 19	230-D4W 147
111112 124	17454 16	18123 17	19502 19	230-D6 147
111113 124	17462 16	18124 17	19503 19	230-D6W 147
111114 124	17464 16	18130 18	200-240 99	230-DC3 149
111115 124	17515 15	18140 18	20122 161	230-DC3W 149
111116 124	17516 15	18160 17	20122 159	230-DC4 149
111117 124	17518 15	18161 17	20133 162	230-DC4W 149
111118 124	17519 15	18180 17	20-3132-18 31	230-DC6 149
111121 125	17520 15	18200 17	20-3132-24 31	230-DC6W 149
111123 124	17521 15	18202 17	20-3132-36 31	230-DCLIP 150
111128 125	17522 15	18231 17	20-3132-48 31	230-DCLIP-10 150
111130 125	17523 15	18232 17	20-3135-18 31	230-DE3 149
111131 125	17532 15	18240 17	20-3135-24 31	230-DE3B 149
111133 125	17533 15	18370 18	20-3135-36 31	230-DE3W 149
114301 125	17534 15	18387 18	20-3135-48 31	230-DE4 149
114302 125	17535 15	18421 18	216-259 99	230-DE4B 149
124-156 99	17536 15	18422 18	216-259220 99	230-DE4W 149
124-156220 99	17537 15	18425 18	216-259330 99	230-DE6 149
124-156330 99	17542 16	18426 18	23010 51	230-DE6W 149
14145 22	17543 16	18427 18	230-14-4 114	230-DL16 41
14175 22	17544 16	189-227 99	230-14-4S 114	230-DL16-20 41

PART NUMBER INDEX cont'd

230-DLF16 41	230-FH4-KITW 150	230-TJ4B 148	30-3132-24 31	37150R 97
230-DLF18 41	230-FJ3 149	230-TJ4W 148	30-3132-30 31	37175H 97
230-DLF20 41	230-FJ3W 149	230-TJ6 148	30-3132-36 31	37175R 97
230-DLF25 41	230-FJ4 149	230-TJ6W 148	30-3132-48 31	37200H 97
230-DLF32 41	230-FJ4W 149	230-WC3 147	30-3132-60 31	37200R 97
230-DLFY 41	230-FR3 149	230-WC3B 147	30-3132-72 31	37250H 97
230-DPPL 41	230-FR3W 149	230-WC3W 147	3036-2 3	37250R 97
230-DPPM 41	230-FR4 149	230-WC4 147	3036-3 3	37300H 97
230-DSCREW 150	230-FR4W 149	230-WC4B 147	3040-2 3	37300R 97
230-EB3 148	230-FR6 149	230-WC4W 147	3040-3 3	37300R-SWP 97
230-EB3B 148	230-FR6W 149	230-WC6 147	3143-2 3	37350H 97
230-EB3W 148	230-IK3 150	230-WC6W 147	315-20 44	37350R 97
230-EB4 148	230-IK3W 150	230-WR3 149	32-3 3	37350R-SWP 97
230-EB4B 148	230-IK4 150	230-WR3W 149	3232-2 3	37400H 97
230-EB4W 148	230-IK4W 150	230-WR4 149	3232-3 3	37400R 97
230-EB6 148	230-IKC3 150	230-WR4W 149	3237-3 3	37450H 97
230-EB6W 148	230-IKC3W 150	230-WR6 149	324-388 99	37450R 97
230-EIN3 148	230-IKC4 150	230-WR6W 149	325-12 44	37500H 97
230-EIN3B 148	230-IKC4W 150	230-WS2 147	340-408 99	37500R 97
230-EIN3W 148	230-INJ462 150	233-292 99	3434-2 3	37550R 97
230-EIN4 148	230-INJ465 150	233-292220 99	357-20 158	37600H 97
230-EIN4B 148	230-LFB3 148	2424-2 3	358-20 158	37600R 97
230-EIN4W 148	230-LFB3B 148	2424-3 3	362-16 44	37700H 97
230-EIN6 148	230-LFB3W 148	2436-2 3	3636-2 3	37800H 97
230-EIN6W 148	230-LFB4 148	2436-3 3	3636-3 3	37800R 97
230-FB3 147	230-LFB4B 148	2442-2 3	3640-2 3	378-440 99
230-FB3B 147	230-LFB4W 148	24-458 124	3640-3 3	3842-3 3
230-FB3W 147	230-LFB6 148	24-460 124	3648-2 3	3GJ0330 97
230-FB4 147	230-LFB6W 148	2448-3 3	3648-3 3	3GJ0515 97
230-FB453 148	230-MB14W 8	25001 129	3660-3 3	3GJ0520 97
230-FB453B 148	230-MB17W 8	2601 160	37030H 97	3GJ0525 97
230-FB453W 148	230-MB24W 8	2602 160	37040H 97	3GJ0530 97
230-FB454 148	230-MB36W 8	2603 160	37050H 97	3GJ0535 97
230-FB454B 148	230-MBCW 8	2626-3 3	37050HB 97	3GJ0540 97
230-FB454W 148	230-PFB3 150	270-324 99	37050R 97	3GJ0545 97
230-FB456 148	230-SF3 147	270-324220 99	37060H 97	3GJ0555 97
230-FB456W 148	230-SF3W 147	270-324330 99	37075H 97	3GJ1025 97
230-FB4B 147	230-SF4 147	3030-2 3	37075HB 97	3GJ1060 97
230-FB4W 147	230-SF4W 147	3030-3 3	37075R 97	3GJ1520 97
230-FB6 147	230-TC34 149	30-3131-24 31	37100H 97	3GJ7530 97
230-FB6W 147	230-TC34W 149	30-3131-36 31	37100HB 97	3GJ7535 97
230-FH3-KIT 150	230-TC46 149	30-3131-48 31	37125H 97	3GJ7545 97
230-FH3W-KIT 150	230-TC46W 149	30-3132-12 31	37125R 97	3GJ7555 97
230-FH4-KIT 150	230-TJ4 148	30-3132-18 31	37150H 97	3GR0325 97

PART NUMBER INDEX cont'd

3GR0330.....97	4224.....68	45250R.....98	4718-12.....134	4JR7540U.....99
3GR0335.....97	4224CX.....68	45300H.....98	4766-3.....3	4JR7545.....98
3GR0340.....97	4224NX.....68	45300HU.....99	4848-3.....3	4JR7545U.....99
3GR0425.....97	4226.....68	45300R.....98	4JJ0525.....98	4JR7550.....98
3GR0435.....97	4226CX.....68	45350H.....98	4JJ0530.....98	4JR7550U.....99
3GR0515.....97	4231.....68	45350HU.....99	4JJ0535.....98	4JR7555.....98
3GR0520.....97	4252.....68	45350R.....98	4JJ0540.....98	4JR7555U.....99
3GR0525.....97	4252CX.....68	45400H.....98	4JJ0545.....98	4JR7560.....98
3GR0530.....97	4253.....68	45400HU.....99	4JJ0555.....98	4JR7560U.....99
3GR0535.....97	4253CX.....68	45400R.....98	4JJ0560.....98	4JR7570.....98
3GR0540.....97	4254CX.....68	45450H.....98	4JJ1055.....98	4JR7580.....98
3GR0545.....97	4293.....86	45450HU.....99	4JJ7535.....98	4WF-01.....165
3GR0550.....97	4293CX.....86	45450R.....98	4JJ7540.....98	5002.....76
3GR0555.....97	4294.....86	45500H.....98	4JJ7545.....98	50302.....25
3GR0560.....97	4294CX.....86	45500HU.....99	4JR0440.....98	5031.....81
3GR0570.....97	4296.....86	45500R.....98	4JR0520.....98	5033.....81
3GR0580.....97	4296CX.....86	4550-3.....3	4JR0525.....98	5035.....81
3GR1035.....97	43-53220.....99	45550H.....98	4JR0525U.....99	5036.....81
3GR1080.....97	436-20.....56	45550R.....98	4JR0530.....98	5041.....81
3GR7530.....97	45020H.....98	4558-3.....3	4JR0530U.....99	5042.....81
3GR7540.....97	45030H.....98	45600H.....98	4JR0535.....98	5046.....81
3GR7555.....97	45040H.....98	45600HU.....99	4JR0535U.....99	5053-3.....3
3GR7560.....97	45050H.....98	45600R.....98	4JR0540.....98	5-05790.....47
3GR7580.....97	45050HU.....99	45700H.....98	4JR0540U.....99	5-10.....136
3WF-01.....165	45050R.....98	45700HU.....99	4JR0545.....98	5-100020.....138
400-480.....99	45060H.....98	45700R.....98	4JR0545U.....99	5-100030.....138
4042-3.....3	45075H.....98	45800H.....98	4JR0550.....98	510-3400.....141
410212.....165	45075HU.....99	45800HU.....99	4JR0550U.....99	510-3400-10.....141
410239.....125	45075R.....98	45800R.....98	4JR0555.....98	510-437338.....138
4147-2.....3	45100H.....98	460-552.....99	4JR0555U.....98	510-438338.....138
4200AX.....68	45100HU.....99	4700-12.....134	4JR0560.....98	5107.....76
4204.....68	45100R.....98	4700-34.....134	4JR0560U.....99	510-D102338.....138
4204CX.....68	45125H.....98	4701-12.....134	4JR0570.....98	510-D304020.....138
4205CX.....68	45125HU.....99	4701-34.....134	4JR0580.....98	510-D304030.....138
4213.....68	45125R.....98	4703-34.....134	4JR0580U.....99	510-D309020.....138
4213CX.....68	45150H.....98	4704-12.....134	4JR1055.....98	510-D309030.....138
4214.....68	45150HU.....99	4704-34.....134	4JR1060.....98	510-D323020.....138
4214CX.....68	45150R.....98	4706-34.....134	4JR1080.....98	510-D323030.....138
4215.....68	45175H.....98	4707-12.....134	4JR7525.....98	510-D441020.....138
4215CX.....68	45200H.....98	47072-12.....134	4JR7530.....98	5-11830.....22
4220.....68	45200HU.....99	47072-34.....134	4JR7530U.....99	5-11840.....22
4220CX.....68	45200R.....98	4707-34.....134	4JR7535.....98	5-11853.....22
4221.....68	45250H.....98	4711-12.....134	4JR7535U.....99	5-11866.....22
4221CX.....68	45250HU.....99	4711-34.....134	4JR7540.....98	5-11879.....22

PART NUMBER INDEX cont'd

5-12 136	5-33570 47	540-278HX0002. 128	540-DISP..... 45	542-25015 121
513-31403D 34	5-34790 47	5-404 138	540-FCTMC5 129	5-42272 47
513-31403D 42	5380AX..... 79	540-42545 50	540-FCTMN1 129	5-4227R 47
5-14 136	5381 79	5-405 138	540-FCTMS1 129	542-76220 121
515-J2000..... 142	538-1/2 15	540-506 126	540-FCTMS2 129	5-429005 140
515-J3000..... 142	538-1/2 176	540-508 126	540-GUN..... 160	5-429007 140
5200 78	538-1/4 15	540-509 126	540-HU1L..... 51	5-429010 140
5-2002 138	538-1/4 176	540-572 160	540-R8CCRF..... 128	5-429015 140
5-2005 138	538-1-1/8 15	540-573 160	540-RB125W 128	5-429020 140
5201 78	538-1-1/8 176	5-406005 139	540-RB414M..... 128	5-429030 140
5223 83	538-1-3/8 15	5-406007 139	540-RB418M..... 128	5-435005 140
5230 78	538-1-3/8 176	5-406010 139	540-RB610HDM .128	5-435007 140
5240 83	538-1-5/8 15	5-406020 139	540-RB614HDM .128	5-435010 140
5242 83	538-1-5/8 176	5-406030 139	540-RB618HDM .128	5-435101 140
5246 80	5382 79	540-648 99	540-RB624HDM .128	5-435102 140
5255 80	538-2-1/8 15	540-6510L..... 129	540-RB636DW ... 128	5-436005 140
525-MT1 132	538-2-1/8 176	540-6510R 129	540-RB636W 128	5-436007 140
525-PT1 132	538-2-5/8 15	540-6716B 129	540-RB656WS ... 128	5-436010 140
525-TORCH 132	538-2-5/8 176	540-6716L..... 129	540-RB810HDM .128	5-436074 141
5-300020 138	5383 79	540-6716R 129	540-RB814HDM .128	5-436101 141
5-300030 138	538-3/4 15	540-6716S 129	540-RB956W 128	5-436102 141
530-10202 136	538-3/4 176	540-6900L..... 129	540-T50M..... 126	5-436131 141
530-10203 136	538-3/8 15	540-6900R 129	540-T50MOC 126	5-437101 141
530-11029 136	538-3/8 176	5-407 138	5-41 128	5-437130 141
530-30752 136	538-3-1/8 15	5-407005 139	5-410 139	5-437131 141
530-30755 136	538-3-1/8 176	5-407007 139	5-410005 140	5-437210 141
530-30756 136	5384 79	5-407131 139	5-410007 140	5-438101 141
530-30757 136	538-4-1/8 15	540-799 50	5-410010 140	5-438131 141
530-30818 136	538-4-1/8 176	5-408 139	5-41041 47	5-447007 140
530-30821 136	5385 79	540-800 50	5-411 139	5-447010 140
530-30834 136	538-5/8 15	540-805 50	5-412 139	5-448007 141
530-30850 136	538-5/8 176	540-806 50	541-300 131	5-449007 140
530-30863 136	538-7/8 15	540-807 50	5-414 139	5-449030 140
530-30876 136	538-7/8 176	540-808 50	5-41411 48	5-450007 140
530-30884 136	5-401005 139	540-811B 50	5-41455 48	545-420 122
530-30885 136	540-1005L..... 51	5-409 139	5-416 138	545-422 122
530-30890 136	5-401007 139	5-409005 139	5-417 138	545-426 122
530-30891 136	5-401010 139	5-409007 139	5-417005 139	545-430 122
530-30893 136	5-401020 139	5-409010 139	5-417007 139	545-440 122
530-31132 136	5-401030 139	540-98237 50	5-417010 139	545-442 122
530-60445 137	5-402007 139	540-AK100..... 55	5-417012 139	545-460 122
5-32 136	540-2110C 45	540-BH1L..... 52	5-417020 139	5-474007 141
5-321020 138	540-2114 51	540-CARABINER.. 130	5-417030 139	5-500 52
5-321030 138	540-278BM0024. 128	540-DB6 55	5-418 138	5-61 128

PART NUMBER INDEX cont'd

56-72 99	5-SCR61-2DPBULK .55	60210CX 66	6-12-4NMSWP 94	620-20-10 114
56-72220 99	5-SCR63-8 55	60210LX 66	61252NX 67	620-202 107
58278040 115	5-SCR63-8BULK... 55	60219 64	6-12-6 93	620-20-3 114
58282040 115	5-SCR71-2 102	60220 64	61256LX 67	620-20-4 114
58282240 115	5-SCR71-2BULK.. 102	60220LX 64	6-12-6NM-2 93	620-20-5 114
58282340 115	5-SCR81 55	60247 67	6-12-6NM 93	620-20-6 114
585-F336 114	5-SCR81-12 55	60251 64	6-12-6NMP 94	620-20-7 114
585-TG 114	5-SCR81-12-100 .. 55	60251CX 64	6-12-6NMR 93	620-20-8 114
585-TG1 114	5-SCR81-12BULK.. 55	60252CX 67	6-12-6NMS 93	6-202-1 54
585-TG2 114	5-SCR81-12W 55	60254 67	6-12-6NMSP 94	6-202-2 54
585-TG3 114	5-SCR81-2 55	60254CX 67	6-12-6NMSWP 94	620-252 107
585-TG4 114	5-SCR81-25M..... 55	60254LX 67	6-12-8NMSWP 94	620-253 107
585-TG5 114	5-SCR81-2BULK... 55	60256CX 67	6182 84	620-254 107
585-TG6 114	5-SCR81-2DP 55	60259HX 64	6183 84	620-255 107
585-TG7 114	5-SCR81-2DPBULK .55	60263BCX..... 74	6-1838L..... 40	620-274W 107
585-TG8 114	5-SCR81BULK 55	60263BLX 74	6-1838S 40	6203E..... 90
585-TG9 114	5-SCR81DP 55	60263CX 74	6184 84	620-401 106
590-708 99	5-SCR81DPBULK... 55	60264BCX..... 74	6185 84	620-403 106
59351202 115	5-SCR82 55	60264CX 74	6186 84	620-404 106
59351203 115	5-SCR82-100 55	60265BLX 75	6187 84	620-406 106
5-HW5850 160	5-SCR82BULK 55	60265LX 75	6193 85	620-409 106
5-IG5850 160	5-SCR82W 55	60331B 81	6194 85	620-411 106
5K006..... 91	5-SCR83-4 55	60331BE..... 81	6195X..... 85	6205E..... 90
5-SCR101 55	5-SCR83-4BULK... 55	60331R 81	6-2 41	620-600 106
5-SCR101-12DP ... 55	5-SCR83-4DP 55	6-1 41	62000AX..... 75	620-601 106
5-SCR101-12DPBULK	5-SCR83-4DPBULK .55	6101 79	6200BSX..... 67	620-604 106
..... 55	5-SCRMS..... 55	6102 79	6200HX 65	620-605 106
5-SCR101-2 55	6000 79	6103E..... 90	620-10-2 96	620-608 104
5-SCR101-2DP 55	60000 110	6105E..... 90	620-12-2 96	620-6081 104
5-SCR101-2DPBULK	6001 79	6107E..... 90	620-14-2 96	620-6082 104
..... 55	60010 110	6110E..... 90	620-18-10 114	620-6083 104
5-SCR101BULK..... 55	60020 110	6-1200 22	620-18-2 114	620-6-2 96
5-SCR101DP 55	60030 110	61202 67	620-18-2P 114	620-700 106
5-SCR101DPBULK.55	60040 110	61214 67	620-18-3 114	620-701 106
5-SCR102DP 55	6005 90	61220 64	620-18-3P 114	620-702 106
5-SCR102DPBULK.55	60050 110	61221CX 64	620-18-4 114	620-703 106
5-SCR103-4 55	60070 110	61221LX..... 64	620-18-5 114	620-704 106
5-SCR103-4BULK.. 55	6010 90	61223LX..... 64	620-18-6 114	620-705 106
5-SCR103-4DP 55	60100 110	61233LX..... 65	620-18-6P 114	6207E..... 90
5-SCR103-4DP100	6011 79	61234LX..... 64	620-18-7 114	6208 66
..... 55	60110 110	61235LX..... 64	620-18-8 114	620-8-2 96
5-SCR103-4DPBULK	60200 110	6-12-4 93	620-18-8P 114	6208LX..... 66
..... 55	60202 110	6-12-4NM 93	620-200 107	6209 66
5-SCR61-2DP 55	60210 66	6-12-4NMSP 94	620-201 107	6209LX..... 66

PART NUMBER INDEX cont'd

6210 66	623-006 116	625-2132W 106	625-S19 107	6268BMX 75
6210E 90	623-007 116	625-2134V 106	625-S20 107	6269 75
6211 66	623-008 116	625-2134W 106	626-10S 104	6269LX 75
6211CX 66	623-012 117	625-270W 106	626-10T 103	6269MX 75
6212 66	623-013 117	6252LX 67	626-15 104	626-AT0003 104
6212CX 66	623-014 117	625-304 96	626-15S 104	626-AT0005 104
6213 64	6230CX 66	625-305 96	626-15T 103	626-AT03LED 104
6213CX 64	6231 66	6253CX 67	6261BCX 75	626-AT05LED 104
6214 64	6231CX 66	6253LX 67	6261CX 75	626-HASR10 103
6214CX 64	6231LX 66	6255 67	626-20 104	626-HASR15 103
6215 67	6232 66	6255CX 67	626-20S 104	626-HASR20 103
6216 67	6232CX 66	6255LX 67	626-20T 103	626-HASR25 103
6216CX 67	6232LX 66	6257 67	626-23133 104	626-HASR30 103
6216LX 67	6233 64	6257NX 67	626-25 104	626-HASR40 103
6217 66	6233LX 64	6258 65	626-25T 103	626-HASR60 103
6217CX 66	6234 64	625-800 96	626-26311 104	6270 65
6217LX 66	6234LX 64	625-801 96	6-2626L 40	6270LX 65
6218 64	6235 64	625-810 96	6262BCX 75	6272 67
6218CX 64	6235CX 64	625-811 96	6262BLX 75	6-2739L 40
6218LX 64	6235LX 64	6258CX 65	6262BMX 75	6274 67
6219 64	6236LX 67	6259 65	6262CX 75	6-2748L 40
6219LX 64	6237 67	6259CX 65	6262LX 75	6274LX 67
6220 64	6237LX 67	625-AF10 22	6262MX 75	6276 67
6220CX 64	6238 67	625-AF12 22	626-30 104	6-2763L 40
6222 66	6238LX 67	625-AF14 22	626-30S 104	6276LX 67
6222LX 66	6239 67	625-AF6 22	626-30T 103	6277 65
6223 66	6239LX 67	625-AF8 22	626-38071 104	6277NX 65
6223LX 66	623-MIX 117	625-B1 108	626-38073 104	6281 64
6224 64	6241 66	625-CL115 107	626-38632 104	6281LX 64
6224CX 64	6242 66	625-CL120 107	626-38636 104	6282 64
6226CX 67	6-2424L 40	625-CL220 107	6263BCX 75	6282LX 64
6227 67	6242LX 66	625-CL230 107	6263BDX 75	6283LX 65
6227LX 67	6244 66	625-CL240 107	6263BLX 75	6285 65
6228 67	6244LX 66	625-CL250 107	6263CX 75	6285LX 65
6228LX 67	6251 64	625-CR15W 106	6263DX 75	6286 65
6229 64	625-1301W 106	625-CR20W 106	6263LX 75	6287CX 66
6229LX 64	625-16-6 108	625-CS120W 106	6264BCX 74	6287XX 66
6230 66	625-16-690 108	625-IS5 96	6264CX 74	6288 65
623-000 116	625-183 96	625-S13 107	6264LX 74	6288LX 65
623-001 116	6251CX 64	625-S14 107	6265BCX 74	6289 65
623-002 116	6251LX 64	625-S15 107	6265BLX 74	6289LX 65
623-003 116	6252 67	625-S16 107	6266BLX 74	6291 86
623-004 116	625-2132B 106	625-S17 107	626-6S 104	6291CX 86
623-005 116	625-2132V 106	625-S18 107	6267MX 75	6292 86

PART NUMBER INDEX cont'd

6292CX 86	6335R 81	640-142 96	650-023 23	6722-2X..... 78
6293 86	6335W 81	6402 77	650-031 23	6724 78
6293CX 86	6336 82	6403 77	650-036 23	6724-2X..... 78
6294 86	6337 82	6404 77	650-038 23	6730 77
6294CX 86	6338 82	6405CM..... 90	650-074 23	6731 77
6295X..... 86	6339XL..... 82	6407CM..... 90	6500A..... 77	6732 77
6296 86	6340 82	640-845 96	6501 77	6733 77
6296CX 86	6341 82	640-AF2..... 25	650-100 22	6-733 42
6298 86	6342 82	640-AF25..... 25	6501CX 77	6-734 42
6298LX..... 86	6343 82	640-AF3..... 25	6502 77	6735 77
6-3 41	6-34-4 93	640-FD2B..... 25	650-200 22	6-735 42
6301 91	6-34-4NM 93	640-FD2S..... 25	6503 77	6-736 42
6303 91	6-34-4NMSP 94	640-FD3S..... 25	650-300 22	675-P521U 113
6-3050 22	6-34-6 93	640-FSK2 25	6503CX 77	675-P621U 113
6-3030L..... 40	6-3460 111	640-FSK3 25	6505 77	675-P721UT..... 113
6-3050L..... 40	6-34-6NM-2 93	640-UL25..... 26	6505LX 77	675-P722U 113
6-3060L..... 40	6-34-6NM 93	640-UL3..... 26	6-5070 22	675-PSD010BF... 113
6-3060S 40	6-34-6NMR 93	6410CM..... 90	6526 77	675-PSD111 113
63070 85	6-34-6NMS 93	6411 123	6528 77	675-PSDH121 ... 113
6310X..... 80	6-34-6NMSP 94	641-14 158	6601 77	675-PSM30SA 113
6311 80	6-34-8 93	6412 77	6602 77	675-PSM40SA 113
6312 80	6-34-8NM 93	6413 77	6603 77	68000HX 78
6321 80	6360B 81	6414 77	6622 77	6803 91
6-321 131	6360R 81	6415 77	6623 77	6853 78
6322 80	6360W 81	6416 77	6641 77	6855 78
6-3263L..... 40	6361B 82	64235201 115	6642 77	6858 78
6-330 42	6361R 82	64275801 115	6643 77	6859 78
6330-4 82	6362B 82	64846401 115	6644 77	6865 78
6330-6 82	6362W 82	6-5 41	6645 77	6866 78
6331 82	6363W 82	650-001 23	6685 77	6876 78
6332B 81	6364B 82	650-002 23	6700AX..... 77	6900AX..... 78
6332G..... 81	6364R 82	650-003 23	6701 77	6903 91
6332R 81	6364W 82	650-005 23	6702 77	6905 91
6332W 81	6365R 82	650-006 23	6703 77	6907 91
6333B 81	6-3660L..... 40	650-008 23	6703CM..... 90	6-9011 22
6333G 81	6-3660S 40	650-010 23	6704 77	6943CX 78
6333R 81	6370 85	650-011 23	6704-2X..... 77	6945CX 78
6333W 81	6371 85	650-012 23	6705CM..... 90	6946CX 78
6334B 81	6383-325 82	650-013 23	6706 77	6953CX 78
6334G 81	6383-35 82	650-014 23	6706-2X..... 77	6955CX 78
6334R 81	6384-325 82	650-016 23	6707CM..... 90	6956CX 78
6334W 81	6384-35 82	650-017 23	6-7090 22	6-9718 42
6335B 81	6401 77	650-020 24	6710CM..... 90	6-CT700F..... 131
6335G 81	640-122 96	650-021 23	6722 78	6-FT80H..... 131

PART NUMBER INDEX cont'd

6-FT80R 131	701-013 134	710-185G 24	7142LX 70	7-38B 42
6-GPK035 126	701-014 134	7101CX 71	7146 70	7-38B50 42
6-HAB-BG 12	701-015 134	7101HCX 71	7-14B 42	7-38P 42
6-HDT304K 131	701-017 134	7102CX 71	7-14B50 42	7-58 41
6-HG15 126	701-018 135	7102HCX 71	7-14P 42	7-60 8
6-HK2748 40	701-019 135	7103CX 71	7-200 54	7-64 8
6-HK2748-1 40	701-020 135	7-1058 183	7233RLX 70	7-4000 54
6-HK2748-SAM 264	701-023 135	7105LX 71	7234RLX 70	7-4001 54
6-HK2766 40	701-025 135	7106CX 71	7235RLX 70	7-4100 54
6-HK2766-1 40	701-028 135	7-1078 183	7236RLX 70	741-001 49
6-HK3050 40	701-029 135	710-A16100 24	72-88220 99	741-002 49
6-HK3050-1 40	701-030 135	710-A1650 24	72-88330 99	741-003 49
6-HK3050HD 40	701-031 135	710-A1710 24	7302 70	7-4200 54
6-HK3060 40	701-032 135	7-10KOTN100 103	7303 70	7-4300 54
6-HK3060-1 40	701-033 135	7-10KOTN30 103	7311L 70	7-4400 54
6-HK3060HD 40	701-034 135	7-10KOTN35 103	7-316 41	7-4500 54
6-HK3070HD 40	701-035 135	7-10KOTN40 103	7316L 70	750-10100 95
6-HK3364FUR 40	701-037 135	7-10KOTN45 103	7316X 70	750-10500 95
6-HK3378FUR 40	701-038 135	7-10KOTN50 103	7317L 70	750-12100 95
6-M22 41	701-039 135	7-10KOTN60 103	7317X 70	750-121000 95
6-M24 41	701-040 135	7-10KOTN70 103	7321X 70	750-125100 95
6-M26 41	701-041 134	7-10KOTN80 103	7-34 41	750-1550 95
6-M2748 41	701-043 134	7-10KOTN90 103	7-3412 183	750-2050 95
6-M2763 41	701-046 135	7-10P 42	7-341-18 183	750-2LTC50 96
6-M30 41	7033 77	710-P100 24	7-341-58 183	750-2LTC75 96
6-M3030 41	7034 77	7111CX 71	7-342-18 183	750-2LTC9050 96
6-M3030-SAM 264	7036X 77	7111X 71	7-342-58 183	750-2LTC9075 96
6-M3050 41	7066X 77	7-12 41	7-3434 183	750-34100 95
6-M3060 41	708-850 99	7-121-18 183	7-3438 183	750-34800 95
6-M3263 41	7-10 41	7-1212 183	7-3458 183	750-38100 95
6-P3030L-SAM 264	7-100 54	7-121-38 183	7-3478 183	750-401 142
6-R50A 22	710-001 24	7-121-58 183	7-34B 42	750-402 142
6-REF401 127	710-002 24	7-122-18 183	7-34B50 42	750-500 95
6-T1191 132	710-003 24	7-122-58 183	7-34P 42	750-600 95
6-T482 132	710-004 24	7-123-18 183	7-38 41	750-MLT50 95
6-T744 128	710-005 24	7-1234 183	7-3812 183	750-MLT75 95
701-001 134	710-100 25	7-1238 183	7-381-18 183	750-MLT9050 95
701-002 134	710-101 25	7-1258 183	7-381-38 183	750-MLT9075 95
701-003 134	710-102 25	7-1278 183	7-381-58 183	750-NMLT100 95
701-006 134	710-103 25	7-12B 42	7-382-18 183	750-NMLT125 95
701-007 134	710-104 24	7-12B50 42	7-382-58 183	750-NMLT150 95
701-009 134	710-105 24	7-12P 42	7-3834 183	750-NMLT4550 95
701-011 134	710-106 24	7-14 41	7-3838 183	750-NMLT4575 95
701-012 134	710-182G 24	7142 70	7-3858 183	750-NMLT50 95

PART NUMBER INDEX cont'd

750-NMLT5090-F..95	799-004 50	7-ECC50730 123	7-S21038 184	8203C 80
750-NMLT75 94	799-005 50	7-ECC50735 123	7-S21810 184	8220M..... 80
750-NMLT7590-F..95	799-006 50	7-L300..... 24	7-S21812 184	8233 80
750-NMLT90100 ..95	799-010 50	7-L300..... 117	7-S21834 184	8282LX 85
750-NMLT90125 ..95	799-011 50	7-P24..... 24	7-S21838 184	8284 85
750-NMLT905094	799-012 50	7-P24..... 117	7-S25810 184	8284CX-B..... 85
750-NMLT907595	799-021 50	7-P36..... 24	7-S25812 184	8286 85
750-P60NF..... 94	799-022 50	7-P36..... 117	7-S25834 184	8286CX-B..... 85
750-RC841 96	799-024 50	7-P36B..... 24	7-S25838 184	829-995 99
750-RC842 96	799-025 50	7-P36B..... 117	7-S31810 184	84DCPLUS..... 161
750-SLTC50 95	799-040 50	7-P48..... 24	7-S31812 184	87DCPLUS..... 162
750-SLTC75 95	799-041 50	7-P48..... 117	7-S31834 184	88-108 99
750-SLTC905095	7-AD010000 123	7-P48B..... 24	7-S31838 184	88-108220 99
750-SLTC907595	7-AL9V 45	7-P48B..... 117	7-S3410 184	88-108330 99
750-TZNMLT100...95	7-AL9V-12 45	7-S0012 184	7-S3412 184	89000 108
750-TZNMLT125...95	7-ALAA 45	7-S10010 184	7-S3434 184	89002 109
750-TZNMLT150...95	7-ALAA-24 45	7-S10012 184	7-S3438 184	89003 109
750-TZNMLT200...95	7-ALAAA 45	7-S11010 184	7-S35810 184	89006 109
750-TZNMLT38.....95	7-ALAAA-18 45	7-S11012Y..... 184	7-S35812 184	89008 109
750-TZNMLT90100.95	7-ALC..... 45	7-S11034 184	7-S35834 184	89009 109
750-TZNMLT90125	7-ALC-12..... 45	7-S11038 184	7-S3810 184	89223 108
.....95	7-ALD..... 45	7-S11810 184	7-S3812 184	89231 108
750-TZNMLT90150.95	7-ALD-12..... 45	7-S11812 184	7-S3834 184	89233 108
750-TZNMLT9038.95	7-CRNR100 103	7-S11834 184	7-S3838 184	89236 108
750-TZNMLT9050.95	7-CRNR15 103	7-S11838 184	7-S40010 184	89238 108
750-TZNMLT9075.95	7-CRNR20 103	7-S1210 184	7-S40012 184	89312 108
755-303SW 94	7-CRNR25 103	7-S1212 184	7-S40034 184	89350 108
7-5811 117	7-CRNR30 103	7-S1234 184	7-S41810 184	89DC 162
7-5811-B 117	7-CRNR35 103	7-S1238 184	7-S41812Y..... 184	8-FWH16..... 56
7-58B 42	7-CRNR40 103	7-S12512 184	7-S41834 184	8-WH16 56
7-58B50 42	7-CRNR45 103	7-S13810 184	7-S5810 184	900-1 29
7-58P..... 42	7-CRNR50 103	7-S13812 184	7-S5812 184	900-10 29
770-15 44	7-CRNR60 103	7-S13834 184	7-S5834 184	900-11 29
7-711 117	7-CRNR70 103	7-S13838 184	7-S5838 184	900-14 29
7-711-B 117	7-CRNR80 103	7-S15810 184	7-S7810 184	900-15 29
7-78 41	7-CRNR90 103	7-S15812 184	7-S7812 184	900-16 29
7-78P..... 42	7-CVMINITUBE 41	7-S15834 184	7-S7834 184	900-17 29
7-80045 54	7-ECC12100 123	7-S15838 184	7-S7838 184	900-3 29
7-806 45	7-ECC1225 123	7-S20010 184	7-TLC10625..... 123	900-4 29
7-80632 53	7-ECC1250 123	7-S20034 184	7-TLC10630..... 123	900-5 29
7-80633 53	7-ECC16100 123	7-S20038 184	800-008 54	900-6 29
799-001 50	7-ECC1625 123	7-S21010 184	800-009 54	900-8 29
799-002 50	7-ECC1650 123	7-S21012 184	8200M..... 80	900-9 29
799-003 50	7-ECC50725 123	7-S21034 184	8201C 80	91-2032 31

PART NUMBER INDEX cont'd

91-3042 31	ACB-30-AL 10	B-129 122	BNT-32 161	BPN-2 32
92-3232 31	ACB-36 10	B-12H 142	BP-46 36	BPN-20 32
92-4242 31	ACB-36-AL 10	B-131 122	BP-46-230 36	BPN-21 32
9410SSR 162	ACB-42 10	B-132 122	BPF-01 32	BPN-22 32
944KIT 162	ACB-42-AL 10	B-16H 142	BPF-02 32	BPN-23 32
947KIT 162	ACB-48 10	B-2 121	BPF-03 32	BPN-24 32
948KIT 162	ACB-48-AL 10	B-20H 142	BPF-04 32	BPN-25 32
971KIT 162	ACID-ELIM 166	B-24H 142	BPF-05 32	BPN-26 32
972KIT 162	ACK4 130	B-26 122	BPF-06 32	BPN-28 32
973KIT 166	ACP-10 44	B-27 121	BPF-07 33	BPN-3 32
980 161	ACP24242 5	B-28H 142	BPF-08 33	BPN-30 32
98084KIT 161	ACP24243 5	B-32H 142	BPF-09 33	BPN-32 32
98087KIT 161	ACP30302 5	B-36H 142	BPF-10 33	BPN-34 32
981 159	ACP30303 5	B-4 121	BPF-11 33	BPN-35 32
983KIT 163	ACP32322 5	B-48H 142	BPF-12 33	BPN-37 32
984 163	ACP32323 5	B-4H 142	BPF-13 33	BPN-38 32
985 160	ACP36362 5	B-501 121	BPF-14 33	BPN-39 32
990 161	ACP36363 5	B-502 121	BPF-16 33	BPN-4 32
991 159	ACP36483 5	B-503 121	BPF-17 33	BPN-40 32
992 166	ACP38422 5	B-504 121	BPF-18 33	BPN-41 32
993KIT 166	ACT-6 126	B-505 121	BPF-20 33	BPN-43 32
995 160	ADB-1 105	B6-12-4 93	BPF-21 33	BPN-44 32
999KIT 160	ADB-2 105	B6-12-4NM 93	BPF-22 33	BPN-45 32
A051 92	ADM-1 105	B6-12-6 93	BPF-23 33	BPN-47 32
A066 92	ADM-2 105	B6-12-6NM 93	BPF-25 33	BPN-5 32
A067 92	AER-8 8	B6-34-4NM 93	BPF-26 33	BPN-51 32
A079 92	AER-8BL 8	B6-34-6 93	BPF-27 33	BPN-52 32
A081 92	AEROSOL-STARTER- KIT 157	B6-34-6NM 93	BPF-28 33	BPN-53 32
A129 92	AG-25 54	B-6H 142	BPF-29 33	BPN-54 32
A134 92	AP-DD 39	B-72H 142	BPF-31 33	BPN-6 32
A140 92	AP-DK 39	B-8H 142	BPF-32 33	BPN-7 32
A155 92	AT-1700 111	B-924 122	BPF-33 33	BPN-8 32
A157 92	ATK-1 165	B-925 122	BPF-34 33	BPN-9 32
A163 92	ATK-1P 165	B-926 122	BPN-1 32	BPN-A12 32
A169 92	ATK-4 165	B-927 122	BPN-10 32	BPN-A34 32
A170 92	B-1 121	B-928 122	BPN-11 32	BR115 107
A171 92	B-10 122	B-929 122	BPN-12 32	BR120 107
A172 92	B-10H 142	B-930 122	BPN-13 32	BR130 107
A173 92	B-124 122	B-931 122	BPN-14 32	BR2100 107
A182 92	B-125 122	B-932 122	BPN-15 32	BR215 107
A200 92	B-126 122	B-934 122	BPN-16 32	BR220 107
A202 92	B-127 122	B-935 122	BPN-17 32	BR230 107
A213 92	B-128 122	B-998 121	BPN-18 32	BR240 107
ACB-30 10		BNT-1 161	BPN-19 32	BR250 107

PART NUMBER INDEX cont'd

BR260.....	107	C223C.....	117	C295-0090.....	170	CGB-AER.....	157	CPN1.....	117
BS-25.....	39	C235-0002.....	169	C295-0100.....	170	CH115.....	107	CPN1C.....	117
BS-32.....	160	C235-0025.....	169	C295-0150.....	170	CH120.....	107	CPN2.....	117
C10.....	120	C235-0050.....	169	C312.....	117	CH215.....	107	CPN2C.....	117
C101-0050.....	169	C235-0090.....	169	C312L.....	117	CH220.....	107	CPN2M.....	117
C101-0100.....	169	C235-0100.....	169	C410-0032.....	170	CH230.....	107	CPN3.....	117
C101-0150.....	169	C235-0150.....	169	C410-0058.....	170	CH240.....	107	CPN3C.....	117
C105-0057.....	169	C235-0215.....	169	C410-0093.....	170	CH250.....	107	CRO70.....	129
C105-0100.....	169	C241.....	117	C410-0107.....	170	CH260.....	107	CR-1.....	49
C105-0150.....	169	C241L.....	117	C410-0149.....	170	CK-141.....	39	CRC-1.....	48
C105-0215.....	169	C242-0001.....	170	C410-0159.....	170	CLL-1.....	166	CRC-13.....	49
C1-2-6.....	120	C242-0002.....	170	C410-0222.....	170	CLL-4.....	166	CRC-1KB.....	48
C154-0100.....	170	C242-0025.....	170	C460-0002.....	171	CM-1000.....	31	CRC-2.....	49
C165-0001.....	170	C242-0050.....	170	C460-0025.....	171	CNH-4K.....	37	CRC-3.....	49
C165-0002.....	170	C242-0090.....	170	C460-0050.....	171	CNHK-4K.....	37	CRC-4-140.....	45
C165-0007.....	170	C242-0100.....	170	C460-0090.....	171	CNM-3M.....	37	CRC-4CF.....	45
C165-0025.....	170	C242-0150.....	170	C460-0100.....	171	CNM-4K.....	37	CRC-4NU.....	46
C165-0032.....	170	C242-0215.....	170	C460-0150.....	171	CNM-5K.....	37	CRC-5.....	49
C165-0050.....	170	C242-0295.....	170	C5.....	120	CNM-BULK.....	37	CRC-6.....	49
C165-0058.....	170	C242-0390.....	170	C512.....	117	CNT-3M.....	37	CRC-7-140.....	46
C165-0090.....	170	C243.....	117	C512L.....	117	CNV-4K.....	37	CRC-7PS.....	46
C165-0093.....	170	C243L.....	117	C533-0050.....	171	CO-1.....	49	CRC-7X.....	46
C165-0094.....	170	C245.....	117	C533-0150.....	171	COOLWELD-32...157		CRC-7Z.....	46
C165-0100.....	170	C245L.....	117	C947-0025.....	171	COV-BRL.....	46	CRC-8.....	48
C165-0107.....	170	C247.....	117	C947-0050.....	171	COV-BR2XL.....	46	CRC-9.....	48
C165-0149.....	170	C2-5.....	120	C947-0100.....	171	COV-BRXL.....	46	CRC-CF2.....	49
C165-0150.....	170	C254-0002.....	167	C947-0150.....	171	COV-WP2XL.....	46	CS-1.....	38
C165-0159.....	170	C254-0100.....	169	C947-0215.....	171	COV-WP3XL.....	46	CS-1-BULK50.....	38
C165-0215.....	170	C254-0150.....	169	C947-0295.....	171	COV-WPL.....	46	CS1200.....	37
C165-0222.....	170	C272-0002.....	169	C947-0390.....	171	COV-WPM.....	46	CS-2.....	38
C165-0223.....	170	C272-0025.....	169	CA-252C.....	120	COV-WPXL.....	46	CS-2-BULK50.....	38
C165-0295.....	170	C272-0050.....	169	CAS-2712.....	53	CP-16.....	36	CS-3.....	37
C165-0304.....	170	C272-0090.....	169	CB-03.....	39	CP-16-230.....	36	CS-3-BULK50.....	37
C165-0390.....	170	C272-0100.....	169	CB-2.....	39	CP-22.....	36	CT-475M.....	120
C165-1498.....	170	C272-0150.....	169	CC-1.....	37	CP-22-230.....	36	CT800.....	130
C170-0003.....	171	C272-0215.....	169	CC33.....	111	CP-22-230T.....	36	CTC-050.....	15
C172-0090.....	171	C290-0002.....	169	CC33-18.....	111	CP-22LP.....	36	CTC-065.....	15
C172-0100.....	171	C290-0025.....	169	CC33-24.....	111	CP-22LP-230.....	36	CTC-080.....	15
C172-0150.....	171	C290-0050.....	169	CCP-L.....	123	CP-22LP-P.....	36	CVENT-2.....	29
C172-0215.....	171	C290-0090.....	169	CCP-M.....	123	CP-22LP-230-P.....	36	CVENT-2AB.....	29
C20.....	120	C290-0100.....	169	CG-AER.....	157	CP-22T.....	36	CVENT-2-EXT.....	29
C222.....	117	C290-0150.....	169	CG-U-L.....	13	CP-CV.....	37	CVENT-3.....	29
C222C.....	117	C290-0215.....	169	CG-U-M.....	13	CP-M115.....	37	CVENT-3-EXT.....	29
C223.....	117	C295-0002.....	170	CG-U-S.....	13	CP-M230.....	37	CVENT-4.....	29

PART NUMBER INDEX cont'd

CVENTCAP2.....29	D408K0250B3B6.181	D61210350179	D61880250179	D618M0300180
CVENTCAP3.....29	D408K0350B3B6.181	D61210400179	D61880300179	D618M0400180
CVENTCAP4.....29	D408K0500B3B6.181	D61210500179	D61880400179	D618M0500180
CVMINI.....36	D408L0250B3B6.181	D61220250179	D61880500179	D62A-1010174
CV-PTRAP38	D408L0350B3B6.181	D61220300179	D61A-4174	D62A-44174
CV-RTRAP38	D408L0500B3B6.181	D61220350179	D61A-8174	D62A-66174
CVS-229	D408M0250B3B6.181	D61220400179	D612K0250180	D62A-88174
CVS-329	D408M0350B3B6.181	D61220500179	D612K0300180	D64A-1010174
CV-TUBE38	D408M0500B3B6.181	D61230250179	D612K0350180	D64A-44174
CV-UTRAP38	D41020250B3B6.177	D61230400179	D612K0400180	D64A-66174
CW-1539	D41020350B3B6.177	D61230500179	D612K0500180	D64A-88174
CW-30120	D41020500B3B6.177	D61280250179	D612L0250.....180	D68A-4B174
D20-3132-1830	D41080250B3B6.177	D61280300179	D612L0300.....180	D68A-6C174
D20-3132-2430	D41080350B3B6.177	D61280350179	D612L0350.....180	D69A-4A174
D20-3132-3630	D41080500B3B6.177	D61280400179	D612L0400.....180	D69A-8D174
D20-3132-4830	D410K0250B3B6.181	D61280500179	D612L0500.....180	D-90113103
D30-3131-2430	D410K0350B3B6.181	D61410250179	D612M0250180	D-90118103
D30-3131-3630	D410K0500B3B6.181	D61410300179	D612M0300180	D90-290Q.....102
D30-3131-4830	D410L0250B3B6.181	D61410350179	D612M0350180	D90-291Q.....102
D30-3132-1830	D410L0350B3B6.181	D61410400179	D612M0400180	D90-292Q.....102
D30-3132-2430	D410L0500B3B6.181	D61410500179	D612M0500180	D90-293Q.....102
D30-3132-3630	D410M0250B3B6.181	D61420250179	D614K0250180	D90-294Q.....102
D30-3132-4830	D410M0350B3B6.181	D61420300179	D614K0300180	D90-295Q.....102
D40620250B3B6.179	D410M0500B3B6.181	D61420350179	D614K0350180	D-90340102
D40620350B3B6.179	D60A-10174	D61420400179	D614K0400180	D-90341102
D40620500B3B6.179	D60A-4174	D61420500179	D614K0500180	D-90342102
D40680250B3B6.179	D60A-8174	D61430300179	D614L0250.....180	D90-360102
D40680350B3B6.179	D61020250B3B6.177	D61430350179	D614L0300.....180	D90-370102
D40680500B3B6.179	D61020350B3B6.177	D61430400179	D614L0350.....180	D90-372102
D406K0250B3B6.181	D61020500B3B6.177	D61430500179	D614L0400.....180	D90-380102
D406K0350B3B6.181	D61080250B3B6.177	D61480250179	D614L0500.....180	D90-382102
D406K0500B3B6.181	D61080350B3B6.177	D61480300179	D614M0250180	D90-384102
D406L0250B3B6.181	D61080500B3B6.177	D61480350179	D614M0300180	DAD032177
D406L0350B3B6.181	D610K0250B3B6.181	D61480400179	D614M0350180	DAD032S177
D406L0500B3B6.181	D610K0350B3B6.181	D61480500179	D614M0400180	DAD052177
D406M0250B3B6.181	D610K0500B3B6.181	D61810250179	D614M0400180	DAD052S177
D406M0350B3B6.181	D610L0250B3B6.181	D61810400179	D614M0500180	DAD053S177
D406M0500B3B6.181	D610L0350B3B6.181	D6180500179	D618K0250180	DAD082177
D40820250B3B6.177	D610L0500B3B6.181	D61820250179	D618K0400180	DAD082S177
D40820350B3B6.177	D610M0250B3B6.181	D61820500179	D618K0500180	DAD083S177
D40820500B3B6.177	D610M0350B3B6.181	D61830250179	D618L0250.....180	DAD084S177
D40880250B3B6.177	D610M0500B3B6.181	D61830300179	D618L0400.....180	DAD163177
D40880350B3B6.177	D61210250179	D61830350179	D618L0500.....180	DAD163S177
D40880500B3B6.177	D61210300179	D61830400179	D618M0250180	DAD164S177

PART NUMBER INDEX cont'd

DAD303 177	DE33 76	DPE303240 101	DSL13-6SVHH .. 177	EC-1 22
DAD303S 177	DEP052 53	DPE303277 101	DSL27-7SVHH .. 177	EC252120 100
DAD304S 177	DEP8001 53	DPE303480 101	DSL27-9SVHH .. 177	EC25224 100
DAD305 177	DEP8002 53	DPE304120 101	DSP-1 105	EC252240 100
DBF083S..... 178	DF-75..... 39	DPE30424 101	DST-5..... 100	EC252277 100
DBF084S..... 178	DG321NRB..... 95	DPE304240 101	DST-6..... 100	EC302120 100
DBF163..... 178	DG322NRB..... 95	DPE304277 101	DT2-10..... 175	EC30224 100
DBF163S..... 178	DG322URB..... 95	DPE401120 101	DT2-4..... 175	EC302240 100
DBF164S..... 178	DMB-1..... 93	DPE40124 101	DT2-6..... 175	EC303120 100
DBF165S..... 178	DMB-2..... 93	DPE402120 101	DT2-8..... 175	EC30324 100
DC20-3131-18..... 30	DMB-3..... 93	DPE40224 101	DTK113..... 38	EC303240 100
DC20-3131-24..... 30	DN1-10..... 175	DPE402240 101	DTK113B..... 38	EC303277 100
DC20-3131-36..... 30	DN1-3..... 175	DPE402480 101	DTK205..... 38	EC402120 100
DC20-3131-48..... 30	DN1-4..... 175	DPE403120 101	DTK207..... 38	EC40224 100
DC20-3132-18..... 30	DN1-6..... 175	DPE40324 101	DTK210..... 38	EC402240 100
DC20-3132-24..... 30	DN5-4..... 175	DPE403240 101	DTP-3..... 105	EC403120 100
DC20-3132-36..... 30	DN5-6..... 175	DPE403480 101	DTT-10 48	EC40324 100
DC20-3132-48..... 30	DNS4-10..... 175	DPE404120 101	DTT-24 48	EC403240 100
DC30-3131-18..... 30	DNS4-12..... 175	DPE404240 101	DU1-10D..... 175	EC403277 100
DC30-3131-48..... 30	DNS4-14..... 175	DPE404277 101	DU1-10E..... 175	EC503120 100
DC30-3131-48..... 30	DNS4-4..... 175	DPE503120 101	DU1-12D..... 175	EC50324 100
DC30-3131-48..... 30	DNS4-6..... 175	DPE50324 101	DU1-4B..... 175	EC503240 100
DC30-3132-18..... 30	DNS4-8..... 175	DPE503240 101	DU1-6B..... 175	EC503277 100
DC30-3132-24..... 30	DP-1 120	DPE602120 101	DU1-6C..... 175	EC603120 100
DC30-3132-36..... 30	DP2-10 175	DPE603120 101	DU1-6D..... 175	EC60324 100
DC30-3132-48..... 30	DP2-4 175	DPE60324 101	DU1-6E..... 175	EC603240 100
DC-4128 47	DP2-6 175	DPE603240 101	DU1-8B..... 175	EC603277 100
DC-9128 47	DP2-8 175	DPE753120 101	DU1-8D..... 175	EC753120 100
DDS-30 94	DPB222R 95	DPE75324 101	DU1-8E..... 175	EC75324 100
DDS-60 94	DPE252120 101	DPE753240 101	DU2-10 175	EC753240 100
DDS-60SW 94	DPE25224 101	DPE903120 101	DU2-12 175	EC753277 100
DDS-60U 94	DPE252240 101	DPE90324 101	DU2-4 175	EC903120 100
DE1-10D 174	DPE253120 101	DPE903240 101	DU2-6 175	EC90324 100
DE13 76	DPE25324 101	DPEAUX10..... 101	DU2-8 175	EC903240 100
DE14 76	DPE253240 101	DPEAUX11..... 101	DU3-10E 176	EC903277 100
DE1-4B 174	DPE301120 101	DPEAUX11QC 101	DU3-6D..... 176	ECO-COIL 156
DE15 76	DPE30124 101	DPEAUX22..... 101	DUCT-FRESH-16 .. 163	ECO-COIL-32 156
DE1-6B 174	DPE301240 101	DPRO64 102	DUCT-FRESH-32 .. 163	ECO-COIL-55 156
DE1-6C 174	DPE302120 101	DPRO66 102	DUCT-FRESH-8 163	ECO-COIL-AER 156
DE1-6D 174	DPE30224 101	DPSG-2S 178	DUS4-4 176	ED1232 84
DE1-8D 174	DPE302240 101	DPSG-3MF..... 178	DUS4-6 176	ED1238 84
DE1-8E..... 174	DPE302277 101	DPSG-3S 178	DX-3 177	ED1240-2 84
DE23 76	DPE303120 101	D-SCALE 165	DX-4 177	ED1262-2 84
DE24 76	DPE30324 101	DSL13-5SVHH .. 177	DXA-5..... 177	ED1262-2I 84

PART NUMBER INDEX cont'd

ED1301 84	ED-AT5 81	EL2430-2 3	EP3434-2 5	FLOW-PLUS-10.... 164
ED1301-I 84	ED-CR15 81	EL2436-2 3	EP3434-3 5	FLOW-PLUS-125.. 164
ED1709 82	ED-CR20 81	EL2436-3 3	EP3636-2 5	FLOW-PLUS-200.. 164
ED1711 82	ED-CR25 81	EL2448-3 3	EP3636-3 5	FLOW-PLUS-25.... 164
ED179 82	ED-CR30 81	EL2626-2 3	EP3640-3 5	FLOW-PLUS-6..... 164
ED1876 83	ED-CR35 81	EL3030-2 3	EP3648-2 5	FMO450 24
ED1876-I 83	ED-CR40 81	EL3030-3 3	EP3648-3 5	FP-22 36
ED1877 83	ED-CR45 81	EL3036-2 3	EP3842-2 5	FP-22-230..... 36
ED252 83	ED-CR50 81	EL3040-2 3	EP3842-3 5	FP-22-CN5K..... 37
ED270 83	ED-CR60 81	EL3232-2 3	EP3870-3 5	FP-36 53
ED270-I 83	EDS-12-6NM 94	EL3232-3 3	EP4040-3 5	FRL12-F 182
ED273 76	EDS-60U 94	EL3244-3 3	EP4558-3 5	FRL14-F 182
ED273CX 76	EFHC-0118-3Y0118	EL3434-2 3	EP4848-3 5	FRL38-F 182
ED277 84 30	EL3636-2 3	EP5042-3 5	FRL58-F 182
ED2867 82	EFHC-0124-3Y0124	EL3636-3 3	EP5060-3 5	FTL3 130
ED2887 83 30	EL3640-2 3	EP5070-3 5	FTL3D 130
ED320 85	EFLF-ISV-HCTP 30	EL3640-3 3	EP5252-3 5	FUL0425 23
ED406 75	EG 158	EL3648-2 3	EP5658-3 5	FUL0625 23
ED419 83	EG-5 158	EL3648-3 3	ET130C1 111	GA-06 120
ED4409 83	EG-55 158	EL3842-2 3	ET22 111	GA-30 120
ED447 84	EG-CP3W 151	EL3842-3 3	ET33 110	GB3020 28
ED448B 84	EG-CP4W 151	EL3870-3 3	ET35G 110	GC275 111
ED4509 83	EG-D3W 151	EL4040-3 3	ET35N 110	GC277 111
ED453 84	EG-D4W 151	EL4558-3 3	ET35R 110	GDK4080 28
ED454 84	EG-DE3W 152	EL4848-3 3	ET35W 110	GG-1 39
ED455 84	EG-DE4W 152	EL5042-3 3	ET44 110	GG-1A 39
ED468 84	EG-EB3W 151	EL5060-3 3	ET75 39	GG-1BOR 39
ED4867 83	EG-EB4W 151	EL5070-3 3	ET75-KIT 39	GG-1H 39
ED494 84	EG-EIN3W 151	EL5252-3 3	F-HF-320 16	GG-1TF 39
ED5225 83	EG-EIN4W 151	EL5658-3 3	F-HF-500 16	GGC-12 39
ED600 85	EG-FB3W 151	EM480 84	FA-01 39	G-LC2XL 52
ED601 85	EG-FB4W 151	EM484 84	FA-02 39	G-LCL 52
ED602 85	EG-FH3W 151	EP1838-3 5	FA-03 39	G-LCM 52
ED603 85	EG-FH4W 151	EP2424-2 5	FAK-10 52	G-LCXL 52
ED610 85	EG-SF3W 151	EP2424-3 5	FAK-25 52	GN-23H 54
ED611 85	EG-SF4W 151	EP2436-2 5	FB-1 8	G-NC2XL 52
ED612 85	EG-TC34W 152	EP2436-3 5	FF-1000-S 9	G-NCM 52
ED613 85	EG-TJ3W 151	EP2448-3 5	FF-1000-S-KIT 9	G-NCL 52
ED620 85	EG-TJ4W 151	EP2626-2 5	FF-250-S 9	G-NCXL 52
ED621 85	EG-WC3W 151	EP3030-2 5	FF-250-UNI 9	GP1-40BL 54
ED710 85	EG-WC4W 151	EP3030-3 5	FF-400-S 9	GV06 112
ED877 83	EL1838-3 3	EP3036-2 5	FF-600-S 9	GV07 112
ED9726 84	EL2424-2 3	EP3232-2 5	FF-600-S-KIT 9	GV08 112
ED-AT3 81	EL2424-3 3	EP3232-3 5	FH-1 104	GV10 112

PART NUMBER INDEX cont'd

GV12 112	HDR-222 113	HT3030-4 4	LIT-FLY-BPPOOL ... 186	LIT-FLY-VENTS..... 186
GV14 112	HEK-500..... 113	HT3232-4 4	LIT-FLY-CDLC 186	LIT-FLY-WS 186
GVA1 112	HFL-4257 113	HT3636-4 4	LIT-FLY-CLAD 186	LSB10-BL..... 179
GVA2 112	HFL-4300 113	HT3648-4 4	LIT-FLY-CLRVUE ... 186	LSB10-W 179
H1840-4 4	HFL-4333 113	HT3842-4 4	LIT-FLY-COIL 186	MAG-1..... 130
H2424-4 4	HFL-5257 113	HT4040-4 4	LIT-FLY-COIL-S 186	MB21 111
H2436-4 4	HFL-5258 113	HT4242-4 4	LIT-FLY-CS1200 .. 186	MB22 111
H3030-4 4	HFL-5300 113	HT4558-4 4	LIT-FLY-CVMINI ... 186	MBK-6 39
H3232-4 4	HFL-5301 113	HVENT-2 29	LIT-FLY-CVMINI-S. 186	MDSCN111 31
H3636-4 4	HFL-5333 113	HVENT-3 29	LIT-FLY-DISC 186	MG-1 125
H3642-4 4	HMD1840-4 4	HW-10P 52	LIT-FLY-DST10 186	MG-RGB 125
H3648-4 4	HMD3030-4 4	IC00-15 15	LIT-FLY-DTP3 186	MG-RGR 125
H3652-4 4	HMD3636-4 4	IC00-20 15	LIT-FLY-DTP3ES... 186	MHP-4 126
H3654-4 4	HMD3648-4 4	IC00-22 15	LIT-FLY-ELITE..... 186	MKT-BANNER 186
H3656-4 4	HMD4040-4 4	IC00-25 15	LIT-FLY-ET 186	MKT-MAT-COILTAB. 187
H3672-4 4	HMR-130..... 113	IC00-28 15	LIT-FLY-FLEX 186	MKT-MERCH-CHEM. 187
H3852-4 4	HP3232-8 6	IC00-32 15	LIT-FLY-FLOW 186	MKT-MERCH-DPWIRE 187
H3865-4 4	HP3636-8 6	IC00-35 15	LIT-FLY-FLXHOSEKIT. 186	MKT-MERCH-FLEX 187
H3872-4 4	HPR-12 8	IC00-40 15	LIT-FLY-FOOT 186	MKT-MERCH-RSC. 187
H4040-4 4	HPR-3..... 8	IC00-42 15	LIT-FLY-GG..... 186	MKT-MERCH-SENTRY 187
H4242-4 4	HPR-3-2P..... 8	IC00-50 15	LIT-FLY-HEAT 186	M K T - M E R C H - SWITCHWIRE 187
H4558-4 4	HPR-3-2PG 8	IC00-54 15	LIT-FLY-HPAD 186	MKT-MERCH-USACAPS 187
H5557-4 4	HPR-3BL 8	IGN-001 28	LIT-FLY-HRP 186	MKT-POP-BROCH. 186
HC5410 79	HPR-6..... 8	IGN-2 28	LIT-FLY-HSI 186	MKT-POP-BROCH4. 186
HC5410X 79	HPR-6-2P..... 8	IGN-2-6P 28	LIT-FLY-MDP 186	MKT-POP-CDLC ... 187
HC5416 79	HPR-6-2PG 8	IGN-401 28	LIT-FLY-MOTORS... 186	MKT-POP-CHEM... 187
HC5416X 79	HPR-6BL 8	IGN-402 28	LIT-FLY-PADS..... 186	MKT-POP-CLRGOND 187
HC5420 79	HPR-EXT 8	IGN-403 28	LIT-FLY-PF..... 186	MKT-POP-CLRSTAND 187
HC5424 79	HS03 112	IGN-405 28	LIT-FLY-PF-S..... 186	MKT-POP-CVTUBE. 187
HC5436 79	HS04 112	IGN-406 28	LIT-FLY-PUMP..... 186	MKT-POP-DEVBACKS.. 187
HC6202 79	HS06 112	IGN-407 28	LIT-FLY-QS 186	MKT-POP-DEVBACKSSLAT 187
HC6203 79	HS08 112	IGN-408 28	LIT-FLY-RPC 186	MKT-POP-DEVCOMBO 187
HCO-128..... 47	HS-144 129	IGN-409 28	LIT-FLY-RPC-S 186	MKT-POP-DEVELEC. 187
HCO-15..... 47	HS-192 130	IGN-410 28	LIT-FLY-RSC 186	MKT-POP-DEVEZC. 187
HCO-7 47	HS-30 130	IGN-412 28	LIT-FLY-SEAL 186	MKT-POP-DTBACKS. 187
HCP-15 47	HS-30-2 130	IQP-120 36	LIT-FLY-SPCH18 .. 186	
HCP-7 47	HS-60 130	IQP-120T..... 36	LIT-FLY-SPRAYER .. 186	
HDR-101 113	HS-60-2 130	ISO-18 6	LIT-FLY-SPRAYER-S. 186	
HDR-102 113	HSA1 112	ISO-2 6	LIT-FLY-SPTEAROFF. 186	
HDR-201 113	HSA2..... 112	ISO-4 6	LIT-FLY-SWITCH.... 186	
HDR-202 113	HSK1 100	JB8265 53	LIT-FLY-TRIPBOOST. 186	
HDR-211 113	HSK5..... 100	LIT-CAT-HVAC..... 186	LIT-FLY-UC 186	
HDR-212 113	HT1840-4..... 4	LIT-FLY-3D 186	LIT-FLY-UCSTRAP.. 186	
HDR-221 113	HT2436-4..... 4	LIT-FLY-3D-S 186	LIT-FLY-UV 186	

PART NUMBER INDEX cont'd

MKT-POP-DTBACKSSLAT 187	MP-6E 6 MP-8 6	PG-PLUS 159 PG-PLUS-5 159	PI351 74 PI352 74	PI913 75 PI914 75
MKT-POP-DUCT ... 187	MP-8C 6	PG-PLUS-55 159	PI353 74	PI929 86
MKT-POP-DUCTSPIN 187	NG-BK2XL 51 NG-BKL 51	PI203 75 PI206 75	PI360 72 PI361 72	PK-2 132 POE100-01 165
MKT-POP-EASEL .. 186	NG-BKXL 51	PI221 86	PI362 72	POE100-32 165
MKT-POP-ET 187	NG-BL2XL 51	PI222 86	PI363 72	POE32-01 165
MKT-POP-HSI 187	NG-BLL 51	PI227 86	PI365 72	POE32-32 165
MKT-POP-PF 187	NG-BLXL 51	PI228 86	PI366 72	POE68-01 165
MKT-POP-QSBACK . 187	MSA-45 172	PI232CX 73	PI367 72	POE68-32 165
MKT-POP-QSMSBOX 187	N20-SD 120 PA10 111	PI237 86 PI301 76	PI368 73 PI370 73	PP-16 137 PP-32 137
MKT-POP-QSWIBOX 187	PA18 111 PA25 111	PI303 76 PI304 75	PI371 73 PI374 72	PP-4 137 PP-8 137
MKT-POP-SWITCHBACK 187	PA25AP 111 PANPATCH 158	PI305 75 PI306 75	PI375 72 PI377 73	PPC-16 137 PPC-4 137
MKT-POSTER-CHT24E 187	PANPATCH-BAG ... 158 PC-600-B 26	PI306CX 75 PI307 75	PI378 73 PI379 73	PPC-8 137 PRO-BLUE 156
MKT-POSTER-CHT24S 187	PC-600-S 26 PC-609-B 26	PI307CX 75 PI309 76	PI381 84 PI382 73	PRO-BLUE-32 156 PRO-BLUE-5 156
MKT-POSTER-CHT36E 187	PC-609-S 26 PC-622-B 26	PI310 75 PI310LX 75	PI383 72 PI384 73	PRO-BLUE-55 156 PRO-BLUE-AER 156
MKT-POSTER-CLRVUE 187	PC-622-S 26 PC-857 26	PI311 74 PI312 74	PI385 73 PI385-34 73	PRO-BROWN 156 PRO-BROWN-5 156
MKT-POSTER-HPAD . 187	PE-012 142	PI315 74	PI386 73	PRO-BROWN-AER . 156
MKT-SAM-ELEC 264	PE-014 142	PI316 75	PI387 72	PRO-BUBBLE-32 .. 161
MKT-SAM-HSI 264	PE-038 142	PI317 75	PI389 73	PRO-GREEN 156
MP-12 6	PE-058 142	PI318 74	PI389-GFI 73	PRO-GREEN-32 ... 156
MP-12C 6	PE-104 142	PI319 73	PI390 72	PRO-GREEN-5 156
MP-12E 6	PF-08 159	PI319CX 73	PI391 72	PRO-GREEN-AER . 156
MP-18 6	PF-16 159	PI320 73	PI393 72	PRO-KLEEN 157
MP-18C 6	PF-ADAPTER 159	PI321 73	PI394 72	PRO-RED+ 157
MP-18E 6	PF-IGUN 159	PI322 74	PI411 74	PRO-RED+32 157
MP-2 6	PF-IHOSE 159	PI326 86	PI412 74	PRO-RED+5 157
MP-2C 6	PF-KIT 159	PI327 86	PI416 74	PRO-RED+AER 157
MP-2E 6	PG-100 159	PI328 86	PI419 74	PRO-THAW 166
MP-3 6	PG-100-5 159	PI330 76	PI426 74	PRO-THAW-1 166
MP-3C 6	PG-100-55 159	PI331 76	PI458 73	PROTREAT-151 ... 164
MP-3E 6	PG-50 159	PI332 76	PI459 73	PROTREAT-152 164
MP-4 6	PG-50-5 159	PI335 79	PI908 75	PROTREAT-161 164
MP-4C 6	PG-50-55 159	PI337-3 86	PI908CX 75	PROTREAT-200 164
MP-4E 6	PG-BG 159	PI340 74	PI909LX 75	PROTREAT-217 164
MP-6 6	PG-BG-5 159	PI341 74	PI912 75	PROTREAT-350 164
MP-6C 6	PG-BG-55 159	PI350 74	PI912LX 75	PRO-YELLOW 157

PART NUMBER INDEX cont'd

PRO-YELLOW-32 .157	QSBF-PA05.....13	QSSX62-1812	QTM-1173	SANI-CND-55.....158
PRO-YELLOW-55 .157	QSCH1000.....10	QSSX62-2412	QTM-2.....173	SC08-1514
PRO-YELLOW-AER .157	QSCH2000.....10	QSSX74-1212	RC-1178	SC08-2014
PS-01.....164	QSLG200013	QSSX74-1812	RLF-8161	SC08-2214
PS-03.....164	QSMS120010	QSSX74-2412	RM-10.....101	SC08-2514
PS-07.....164	QSMS120110	QSTD100012	RM-1G101	SC08-2814
PS-075.....164	QSMS1201SS.....10	QSTD1403-AL.....11	RPC-001214	SC08-3214
PS-1.....160	QSMS120211	QSTD1803-AL.....11	RPC-001414	SC08-3514
PS-20.....164	QSMS120311	QSTD200012	RPC-003414	SC08-4014
PS-40.....164	QSMS120411	QSTD2403-AL.....11	RPC-003814	SC08-4214
PW-16.....137	QSMS120511	QSTD300011	RPC-005814	SC08-5014
PW-32.....137	QSMS180010	QSTD3000-1211	RPC-007814	SC08-5414
PW-4.....137	QSMS180110	QSTD400012	RPC-011814	SC-151
PW-8.....137	QSMS1801SS.....10	QSTD400112	RPC-013814	SC-1044
PWB-16.....137	QSMS180211	QSTD400212	RPC-015814	SC10-1514
PWB-4.....137	QSMS180411	QSTD500012	RPC-FB15	SC10-2014
PWB-8.....137	QSMS180511	QSTD500112	RPC-FB-100.....15	SC10-2214
PWH-16137	QSMS240010	QSTD500212	RS-15.....130	SC10-2514
PWH-4137	QSMS240110	QSTD600012	RS-20.....130	SC10-2814
PWH-8137	QSMS2401SS.....10	QSTD600112	RS-31.....130	SC10-3214
PWU-16137	QSMS240211	QSTD600212	RS-41.....130	SC10-3514
PWU-4137	QSMS240411	QSWB10009	RS-9.....130	SC10-4014
PWU-8137	QSMS240511	QSWB11009	RSC-GRN-02.....166	SC10-4214
PWW-16.....137	QSMS3001-1211	QSWB200010	RSC-GRN-04K....166	SC10-5014
PWW-4.....137	QSMS3001-12EXT.11	QSWB2000SS10	RSC-GRN-10.....166	SC10-5414
PWW-8.....137	QSMS3001-1811	QSWB30009	RSC-GRN-50K....166	SC-1SHU51
QAV-2142	QSMS3001-18EXT.11	QSWB400010	RSC-RED-02166	SC-1WP51
QN-S3.....39	QSMS3001-2411	QSWB4000SS10	RSC-RED-02-E ...166	SC-2544
QSAC100014	QSMS3001-24EXT.11	QSWI100013	RSC-RED-04K....166	SC-BRSHU51
QSAC110014	QSPR100010	QSWI200013	RSC-RED-04K-E...166	SCM-10.....44
QSAC200014	QSRB100013	QSWI300013	RSC-RED-10166	SCM-25.....44
QSAC210014	QSSB42-1212	QSWI300113	RSC-RED-10-E ...166	SCM-5.....44
QSAC510012	QSSB42-1812	QSWI300213	RSC-RED-500166	SC-WPSHU51
QSAC510112	QSSB42-2412	QSWI400013	RSC-RED-50K.....166	SG-139
QSAC510212	QSSB62-1212	QSWI500013	RSC-RED-50K-E...166	SGC-1239
QSAC510412	QSSB62-1812	QSWI600013	RSC-SLV-02166	SG-NV30B.....52
QSAC510512	QSSB62-2412	QSWI100013	RSC-SLV-04K.....166	SG-NV30BC.....52
QSAC520012	QSSB74-1212	QT-1173	RSC-SLV-10166	SG-NV30CB.....52
QSAC520112	QSSB74-1812	QT-100.....173	RSC-SLV-500166	SG-NV30CC.....52
QSAC520212	QSSB74-2412	QT-100G173	RSC-SLV-50K.....166	SPT-W56
QSBB30009	QSSX42-1212	QT-100N173	RSC-TOOL.....166	ST-1048
QSBB40009	QSSX42-1812	QT-2.....173	SANI-CND.....158	ST-2448
QSBF-PA03.....13	QSSX42-2412	QTH-1173	SANI-CND-32.....158	ST-448
QSBF-PA04.....13	QSSX62-1212	QTH-2173	SANI-CND-5.....158	ST75.....39

PART NUMBER INDEX cont'd

STXH120P05 106	TG-30-1 131	UC2442-3 2	VCC-4 172	W121-50 116
STXH240S05 106	TG-30-12 131	UC2448-3 2	VCC-4B 172	W122 115
STXR208Y05N 106	TG-87A..... 39	UC2448-3CA 2	VCR-1 173	W122-100 115
STXR240D05 106	TLC-3-10 111	UC2626-3 2	VCRT-1 173	W122-50 116
STXR480D05 106	TLC-3-12 111	UC2636-3CA 2	VLC-10..... 173	W123 115
STXR480Y05N 106	TLC-3-8 111	UC3030-3 2	VLC-12..... 173	W123-100 115
STXRMBK..... 106	TRIPLE-D..... 156	UC3030-3CA 2	VLC-18..... 173	W123-50 116
SUPER-KOOL..... 161	TRIPLE-D-32..... 156	UC3036-3CA 2	VLC-25..... 173	W124 115
SUPER-KOOL-16.. 161	TRIPLE-D-5..... 156	UC3040-3 2	VLC-4..... 173	W124-100 115
T-1 123	TRIPLE-D-55..... 156	UC3132-3L..... 2	VLC-5..... 173	W124-50 116
T-10 123	TRIPLE-D-AER..... 156	UC3232-3 2	VLC-6..... 173	W125 115
T-11 123	TRIPLE-D-AER-6... 156	UC3232-3CA 2	VLC-8..... 173	W125-100 115
T-12 123	TRIPLE-D-GRAN... 156	UC3237-3 2	VP68-01..... 166	W125-50 116
T-13 123	TRIPLE-D-RTU..... 156	UC3434-3 2	VP68-05..... 166	W141 115
T-14 123	TS-1 108	UC3445-3 2	VP68-32..... 166	W141-100 115
T-1401 102	TS-3 108	UC3539-3L..... 2	VS-4..... 170	W141-50 116
T1404 102	TS-4 108	UC3636-3 2	VST-4 170	W142 115
T-16 123	TT-120 127	UC3636-3CA 19	VST-44 170	W142-100 115
T-20 123	TT-24..... 127	UC3642-3 2	VTR-24 170	W142-50 116
T-21 123	TT-240 127	UC3642-3CA 2	VTS-10 170	W143 115
T2401 102	U3353-3 2	UC3648-3 2	VTS-12 170	W143-100 115
T2403 102	U3650-3 2	UC3648-3CA 2	VTS-14 170	W143-50 116
T2404 102	U3654-3 2	UC3842-3 2	VTS-46 170	W144 115
T3401 102	U3660-3 2	UC4040-3 2	VTS-56 170	W144-100 115
T3403 102	U3865-3 2	UC4040-3CA 2	VTS-68 170	W144-50 116
T3501 102	U3870-3 2	UC4042-3 2	VTS-810..... 170	W145 115
T-409 124	U4054-3 2	UC4044-3L..... 19	VVC-1 170	W145-100 115
T-411 124	U4550-3 2	UV-1 23	W101 115	W145-50 116
T5401 102	U4558-3 2	UV-BULB 23	W101-100 115	W801 115
T6752 102	U4848-3 2	UVEC-07G..... 163	W101-50 116	W801-100 115
T6753 102	U4854-3 2	VA-3-346..... 172	W102 115	W801-50 116
T7752 102	U4866-3 2	VA-34..... 172	W102-100 115	W802 115
T-8 123	U5053-3 2	VA-46..... 172	W102-50 116	W802-100 115
T-9 123	U5056-3 2	VA-68..... 172	W103 115	W802-50 116
TC-007 127	U5252-3 2	VAU-24..... 172	W103-100 115	W803 115
TC-25..... 39	U5557-3 2	VAU-45..... 172	W103-50 116	W803-100 115
TDC-4 5	UA-1 38	VAX-2 172	W104 115	W803-50 16
TDC-6 5	UC1636-3 2	VAX-3 172	W104-100 115	W804-100 115
TDC-8 5	UC1838-3 2	VAX-4 172	W104-50 116	W804-50 116
TDC-10 5	UC1838-3CA 2	VAX-5 172	W105 115	W805 115
TDC-12 5	UC2424-3 2	VAX-6 172	W105-100 115	W805-100 115
TG-05 131	UC2424-3CA 2	VAX-8 172	W105-50 116	WC02 118
TG-10 39	UC2436-3 2	VC-4 172	W121 115	WC03 118
TG-30 131	UC2436-3CA 2	VC-4R 172	W121-100 115	WC04 118

PART NUMBER INDEX cont'd

WC05 118	WG840729HT 88	WT15..... 118
WC06 118	WG840730 88	WT15C..... 118
WC08 118	WG840730HT 88	WTA1 118
WC09 118	WG840731 88	WTB05..... 118
WC10 118	WG840731HT 88	WTB05C..... 118
WC12 118	WG840736HT 88	WTB07 118
WC14 118	WG840737HT 88	WTB07C..... 118
WC16 118	WG840738HT 88	WTB07M 118
WCA1 118	WG840739HT 88	WTB11 118
WG840203 88	WG840746 88	WTB11C..... 118
WG840203HT 88	WG840746HT 88	WTB11C..... 150
WG840204 88	WG840884HT 89	WTB11CR..... 118
WG840204HT 88	WHT20..... 116	WTB11D..... 118
WG840205 88	WHTB10-50..... 116	WTB11M 118
WG840205HT 88	WHTB12-50..... 116	WTB15..... 118
WG840458 144	WHTB14-50..... 116	WTB15C..... 118
WG840458HT 89	WHTR14-50..... 116	WTBA1 118
WG840459 88	WHTW14-50..... 116	WTM05 118
WG840459HT 89	WM1002..... 86	WTM05C..... 118
WG840463 89	WM1003..... 86	WTM07 118
WG840464 89	WM1009..... 86	WTM07C..... 118
WG840465 88	WM1014..... 86	WTM1 118
WG840465HT 89	WP1212-164 182	WTM11 118
WG840466 89	WP1212-50 182	WTM11C..... 118
WG840467 89	WP1214-164 182	WTM14C..... 118
WG840468 88	WP1214-50 182	WTM1C 118
WG840468HT 89	WP1234-50 182	WTM2 118
WG840469 88	WP1234-82 182	WTM2C..... 118
WG840469HT 89	WP1238-164 182	WTMB05C..... 118
WG840583 89	WP1238-50 182	WTMB07 118
WG840584 89	WP1258-164 182	WTMB07C..... 118
WG840585 89	WP1258-50 182	WTMB11 118
WG840586 89	WP1278-50 182	WTMB11C..... 118
WG840587 89	WP1278-82 182	WTMB14C..... 118
WG840588 89	WS-1 37	
WG840589 89	WT04..... 118	
WG840590 89	WT04C..... 118	
WG840595 89	WT05..... 118	
WG840596 89	WT05C..... 118	
WG840727 88	WT07 118	
WG840727HT 88	WT07C..... 118	
WG840728 88	WT11 118	
WG840728HT 88	WT11C..... 118	
WG840729 88	WT11L 118	

ABOUT DIVERSITECH

Founded in 1971, DiversiTech® Corporation is North America's largest manufacturer of equipment pads and a leading manufacturer and supplier of components and related products for the heating, ventilating, air conditioning, and refrigeration (HVAC/R) industry. Headquartered in the Atlanta, Ga., metropolitan area, DiversiTech's mission for its wholesaler partners is to simplify their work. The Company is focused on growth through internal product development, external partnerships and acquisition. Manufacturing a suite of products, which includes a wide range of mechanical, electrical, chemical and structural parts for HVACR systems, DiversiTech brings unparalleled scaling capabilities and supplier expertise. The Company holds numerous patents and operates an advanced R&D materials division dedicated to bringing more value to its customers. The Company maintains over 1 million square feet of manufacturing and distribution space in key U.S., Canadian and European locations. DiversiTech has enjoyed a continued history of successful growth and has acquired industry recognized brand names including Wagner® Manufacturing, Specialty Chemical, EcoPad®, The Black Pad®, Quick-Sling® and Super Seal™. More information is available at www.diversitech.com.



LIT-CAT-HVAC
3039 Premiere Parkway
Suite 600
Duluth, GA 30097
678.542.3600
800.995.2222
www.diversitech.com
©2020 DiversiTech Corporation



DOWNLOAD <http://media.diversitech.com/doc/DOC166624.pdf>