



EDUS 04 - 904

Engineering Data

SPLIT

- Heat Pump -
SEER 13 Models
H-Series



INVERTER

DAIKIN AC (AMERICAS), INC.

Split-System Room Air Conditioners H-Series

Heat Pump		
Wall-Mounted Split System	FTXS09HVJU	RX09FAVJU
	FTXS12HVJU	RX12FAVJU
	FTXS15HVJU	RX15FVJU
	FTXS18HVJU	RX18FVJU
	FTXS24HVJU	RX24FVJU

- 1. Power Supply3
- 2. Functions.....4
- 3. Specifications5
- 4. Dimensions8
 - 4.1 Indoor Units8
 - 4.2 Outdoor Units10
- 5. Wiring Diagrams.....12
 - 5.1 Indoor Units12
 - 5.2 Outdoor Units13
- 6. Piping Diagrams.....14
 - 6.1 Indoor Units14
 - 6.2 Outdoor Units15
- 7. Capacity Tables17
 - 7.1 Heat Pump17
 - 7.2 Capacity correction factor by the length of refrigerant piping
(Reference)22
- 8. Operation Limit.....23
- 9. Sound Level24
 - 9.1 Measuring Location24
 - 9.2 Octave Band Level25
- 10. Electric Characteristics.....29
- 11. Installation Manual30
 - 11.1 Indoor Units30
 - 11.2 Outdoor Units45
- 12. Operation Manual.....60
 - 12.1 Safety precautions.....60
 - 12.2 09/12 Class62
 - 12.3 15/18/24 Class87

13. Optional Accessories	113
13.1 Option List	113
13.2 Installation Manual	114

Cautions

1. Air conditioners should not be installed in areas where corrosive gases, such as acid gas or alkaline gas, are produced.
2. If the outdoor unit is to be installed close to the sea shore, direct exposure to the sea breeze should be avoided and choose an outdoor unit with anti-corrosion treatment.

1. Power Supply

	Indoor Units	Outdoor Units	Power Supply
Wall-Mounted Split Sytem	FTXS09HVJU	RX09FAVJU	1 ϕ , 208-230V, 60Hz
	FTXS12HVJU	RX12FAVJU	
	FTXS15HVJU	RX15FVJU	
	FTXS18HVJU	RX18FVJU	
	FTXS24HVJU	RX24FVJU	

Note: Power Supply Intake ; Outdoor Unit

2. Functions

Category	Functions	FTXS09/12HVJU RX09/12FAVJU	FTXS15/18/24HVJU RX15/18/24FVJU	Category	Functions	FTXS09/12HVJU RX09/12FAVJU	FTXS15/18/24HVJU RX15/18/24FVJU	
Basic Function	Inverter (with Inverter Power Control)	○	○	Health & Clean	Air-Purifying Filter	—	—	
	Operation Limit for Cooling (°FDB)	14~115	14~115		Photocatalytic Deodorizing Filter	—	—	
	Operation Limit for Heating (°FWB)	5~64	5~64		Air-Purifying Filter with Photocatalytic Deodorizing Function	○	○	
	PAM Control	○	○		Titanium Apatite Photocatalytic Air-Purifying Filter	—	—	
Compressor	Oval Scroll Compressor	—	—	Air Filter (Prefilter)	○	○		
	Swing Compressor	○	○	Wipe-clean Flat Panel	○	○		
	Rotary Compressor	—	—	Washable Grille	—	—		
	Reluctance DC Motor	○	○	Filter Cleaning Indicator	—	—		
Comfortable Airflow	Power-Airflow Flap	—	—	Timer	Good-Sleep Cooling Operation	—	—	
	Power-Airflow Dual Flaps	○	○		24-Hour On/Off Timer	○	○	
	Power-Airflow Diffuser	—	—	Night Set Mode	○	○		
	Wide-Angle Louvers	○	○	Worry Free "Reliability & Durability"	Auto-Restart (after Power Failure)	○	○	
	Vertical Auto-Swing (Up and Down)	○	○		Self-Diagnosis (Digital, LED) Display	○	○	
	Horizontal Auto-Swing (Right and Left)	—	○		Wiring Error Check	—	—	
	3-D Airflow	—	○		Anticorrosion Treatment of Outdoor Heat Exchanger	○	○	
	Comfort Airflow Mode	—	—					
3-Step Airflow (H/P Only)	—	—						
Comfort Control	Auto Fan Speed	○	○	Flexibility	Multi-Split / Split Type Compatible Indoor Unit	—	○	
	Indoor Unit Quiet Operation	○	○		Flexible Voltage Correspondence	—	—	
	Night Quiet Mode (Automatic)	—	—		High Ceiling Application	—	—	
	Outdoor Unit Quiet Operation (Manual)	○	○		Chargeless	33ft	33ft	
	INTELLIGENT EYE	○	○	Remote Control	Either Side Drain (Right or Left)	○	○	
	Quick Warming Function	○	○		Power Selection	—	—	
	Hot-Start Function	○	○		5-Rooms Centralized Controller (Option)	○	○	
	Automatic Defrosting	○	○		Remote Control Adapter (Normal Open-Pulse Contact) (Option)	○	○	
Operation	Automatic Operation	○	○	Remote Control Adapter (Normal Open Contact) (Option)	Remote Control Adapter (Normal Open Contact) (Option)	○	○	
	Program Dry Function	○	○		DIII-NET Compatible (Adapter) (Option)	DIII-NET Compatible (Adapter) (Option)	○	○
	Fan Only	○	○					
Lifestyle Convenience	New POWERFUL Operation (Non-Inverter)	—	—	Remote Controller	Wireless	○	○	
	Inverter POWERFUL Operation	○	○		Wired	—	—	
	Priority-Room Setting	—	—					
	Cooling / Heating Mode Lock	—	—					
	HOME LEAVE Operation	○	○					
	Indoor Unit On/Off Switch	○	○					
	Signal Reception Indicator	○	○					
	Temperature Display	—	—					
Another Room Operation	—	—						

Note: ○ : Holding Functions
 — : No Functions

3. Specifications

60Hz 230V

Models	Indoor Units		FTXS09HVJU		FTXS12HVJU	
	Outdoor Units		RX09FAVJU		RX12FAVJU	
			Cooling	Heating	Cooling	Heating
Capacity Rated (Min.-Max.)	Btu/h		8,500 (5,100-8,500)	10,000 (5,100-10,000)	11,500 (5,500-11,500)	11,500 (5,500-11,500)
Moisture Removal	Pt/h		2.3	—	3.2	—
Running Current (Rated)	A		4.56	5.21	6.00	5.20
Power Consumption Rated (Min.-Max.)	W		850 (300-850)	1,120 (290-1,220)	1,350 (300-1,350)	1,100 (310-1,190)
Power Factor	%		81.1	93.4	97.1	92.0
EER (Rated)	Btu/h-W		10.0	—	8.5	—
COP (Rated)En	W/W		—	2.62	—	3.06
Energy Efficiency	SEER/HSPF		13.0	7.7	13.0	7.7
Piping Connections	Liquid	inch (mm)	ϕ 1/4" (6.4 mm)		ϕ 1/4" (6.4 mm)	
	Gas	inch (mm)	ϕ 3/8" (9.5 mm)		ϕ 3/8" (9.5 mm)	
	Drain	inch (mm)	ϕ 11/16" (17.5 mm)		ϕ 11/16" (17.5 mm)	
Heat Insulation			Both Liquid and Gas Pipes		Both Liquid and Gas Pipes	
Max. Interunit Piping Length	feet (m)		65 ft (20 m)		65 ft (20 m)	
Max. Interunit Height Difference	feet (m)		49 ft (15 m)		49 ft (15 m)	
Chargeless	feet (m)		33 ft (10 m)		33 ft (10 m)	
Amount of Additional Charge of Refrigerant	oz/ft		0.22		0.22	
Indoor Units			FTXS09HVJU		FTXS12HVJU	
Front Panel Color			White		White	
Airflow Rate	cfm (m ³ /min)	H	246 (7.0)	253 (7.2)	242 (6.8)	286 (8.1)
		M	197 (5.6)	220 (6.2)	195 (5.5)	237 (6.7)
		L	148 (4.2)	187 (5.3)	148 (4.2)	187 (5.3)
Fan	Type		Cross Flow Fan		Cross Flow Fan	
	Motor Output	W	18		18	
	Speed	Steps	5 Steps, Quiet and Auto		5 Steps, Quiet and Auto	
Air Direction Control			Right, Left, Horizontal and Downward		Right, Left, Horizontal and Downward	
Air Filter			Removable / Washable / Mildew Proof		Removable / Washable / Mildew Proof	
Running Current (Rated)	A		0.18		0.18	
Power Consumption (Rated)	W		40		40	
Power Factor	%		96.6		96.6	
Temperature Control			Microcomputer Control		Microcomputer Control	
Dimensions (HxWxD)	inch (mm)		10-3/4 x 30-7/8 x 7-11/16" (273 x 784 x 195 mm)		10-3/4 x 30-7/8 x 7-11/16" (273 x 784 x 195 mm)	
Packaged Dimensions (HxWxD)	inch (mm)		10-3/16 x 32-13/16 x 12-13/16" (259 x 833 x 325 mm)		10-3/16 x 32-13/16 x 12-13/16" (259 x 833 x 325 mm)	
Weight	Lbs (kg)		16.6 lbs (7.5 kg)		16.6 lbs (7.5 kg)	
Gross Weight	Lbs (kg)		25.0 lbs (11.3 kg)		25.0 lbs (11.3 kg)	
Operation Sound	H/M/L	dBA	38 / 32 / 25	38 / 33 / 28	40 / 33 / 26	39 / 34 / 29
Outdoor Units			RX09FAVJU		RX12FAVJU	
Casing Color			Ivory White		Ivory White	
Compressor	Type		Hermetically Sealed Swing Type		Hermetically Sealed Swing Type	
	Model		1YC23NXD		1YC23NXD	
	Motor Output	W	600		600	
Refrigerant Oil	Type		FVC50K		FVC50K	
	Charge	oz	12.6		12.6	
Refrigerant	Type		R-410A		R-410A	
	Charge	Lbs	1.76		2.20	
Airflow Rate	cfm (m ³ /min)	H	1,120 (31.7)	1,008 (28.5)	1,031 (29.2)	927 (26.3)
		L	816 (23.1)	813 (23.0)	737 (20.9)	737 (20.9)
Fan	Type		Propeller		Propeller	
	Motor Output	W	31		31	
Running Current (Rated)	A		4.38	5.03	5.07	5.02
Power Consumption (Rated)	W		810	1,080	1,310	1,060
Power Factor	%		80.4	93.3	97.1	91.8
Dimensions (HxWxD)	inch(mm)		21-5/8 x 30-1/8 x 11-1/4" (549 x 765 x 285 mm)		21-5/8 x 30-1/8 x 11-1/4" (549 x 765 x 285 mm)	
Packaged Dimensions (HxWxD)	inch(mm)		25 x 34-5/8 x 14-3/16" (635 x 765 x 360 mm)		25 x 34-5/8 x 14-3/16" (635 x 765 x 360 mm)	
Weight	Lbs (kg)		74.0 lbs (33.5 kg)		80.0 lbs (36 kg)	
Gross Weight	Lbs (kg)		86.0 lbs (39 kg)		92.0 lbs (42 kg)	
Operation Sound	H / L	dBA	48 / —	49 / —	49 / —	51 / —
Drawing No.			3D062872A		3D062873A	

Note: ■ The data are based on the conditions shown in the table below.

Cooling	Heating	Piping Length
Indoor ; 80°FDB/67°F WB Outdoor ; 95°FDB/75°F WB	Indoor ; 70°FDB/60°F WB Outdoor ; 47°FDB/43°F WB	25 ft (7.5 m)

Conversion Formulae
kcal/h=kWx860 Btu/h=kWx3414 cfm=m ³ /minx35.3

60Hz 230V

Model	Indoor Units		FTXS15HVJU		FTXS18HVJU	
	Outdoor Units		RX15FVJU		RX18FVJU	
			Cooling	Heating	Cooling	Heating
Capacity Rated (Min.-Max.)	Btu/h		15,000 (6,800-15,000)	18,000 (6,800-21,200)	18,000 (6,800-18,000)	21,600 (6,800-24,000)
Moisture Removal	Pt/h		3.4	—	4.3	—
Running Current (Rated)	A		6.01	7.58	7.67	9.58
Power Consumption Rated (Min.-Max.)	W		1,360 (450-1,360)	1,730 (450-2,540)	1,750 (450-1,750)	2,200 (450-2,620)
Power Factor	%		98.4	99.2	99.2	99.8
EER (Rated)	Btu/h-W		11.0	—	10.3	—
COP (Rated)	W/W		—	3.05	—	2.88
Energy Efficiency	SEER/HSPF		13.0	7.7	13.0	7.7
Piping Connections	Liquid	inch (mm)	φ 1/4" (6.4 mm)		φ 1/4" (6.4 mm)	
	Gas	inch (mm)	φ 1/2" (12.7 mm)		φ 1/2" (12.7 mm)	
	Drain	inch (mm)	φ 11/16" (17.5 mm)		φ 11/16" (17.5 mm)	
Heat Insulation			Both Liquid and Gas Pipes		Both Liquid and Gas Pipes	
Max. Interunit Piping Length	feet (m)		98.4' (30 m)		98.4' (30 m)	
Max. Interunit Height Difference	feet (m)		65.6' (20 m)		65.6' (20 m)	
Chargeless	feet (m)		33' (10 m)		33' (10 m)	
Amount of Additional Charge of Refrigerant	oz/ft		0.22		0.22	
Indoor Unit			FTXS15HVJU		FTXS18HVJU	
Front Panel Color			White		White	
Airflow Rate	cfm (m³/min)	H	519 (14.7)	515 (14.6)	549 (15.5)	609 (17.2)
		M	436 (12.3)	459 (13.0)	476 (13.5)	529 (15.0)
		L	353 (10.0)	402 (11.4)	402 (11.4)	448 (12.7)
Fan	Type		Cross Flow Fan		Cross Flow Fan	
	Motor Output	W	43		43	
	Speed	Steps	5 Steps, Quiet, Auto		5 Steps, Quiet, Auto	
Air Direction Control			Right, Left, Horizontal, Downward		Right, Left, Horizontal, Downward	
Air Filter			Removable / Washable / Mildew Proof		Removable / Washable / Mildew Proof	
Running Current (Rated)	A		0.18		0.18	
Power Consumption (Rated)	W		40		40	
Power Factor	%		96.6		96.6	
Temperature Control			Microcomputer Control		Microcomputer Control	
Dimensions (HxWxD)	inch (mm)		11-7/16 x 41-5/16 x 9-3/8" (291 x 1049 x 238 mm)		11-7/16 x 41-5/16 x 9-3/8" (291 x 1049 x 238 mm)	
Packaged Dimensions (HxWxD)	inch (mm)		13-1/4 x 45-3/16 x 14-7/16" (337 x 1147 x 367 mm)		13-1/4 x 45-3/16 x 14-7/16" (337 x 1147 x 367 mm)	
Weight	Lbs (kg)		26.5 lbs (12 kg)		26.5 lbs (12 kg)	
Gross Weight	Lbs (kg)		38.0 lbs (17 kg)		38.0 lbs (17 kg)	
Operation Sound	H/M/L	dBA	45 / 41 / 36	44 / 40 / 35	45 / 41 / 36	44 / 40 / 35
Outdoor Unit			RX15FVJU		RX18FVJU	
Casing Color			Ivory White		Ivory White	
Compressor	Type		Hermetically Sealed Swing Type		Hermetically Sealed Swing Type	
	Model		2YC32JXD		2YC32JXD	
	Motor Output	W	1,500		1,500	
Refrigerant Oil	Model		FVC50K		FVC50K	
	Charge	oz	21.8		21.8	
Refrigerant	Model		R-410A		R-410A	
	Charge	Lbs	3.75		3.75	
Airflow Rate	cfm (m³/min)	H	1,603 (45.4)	1,367 (38.7)	1,603 (45.4)	1,367 (38.7)
		L	1,451 (41.1)	1,367 (38.7)	1,451 (41.1)	1,367 (38.7)
Fan	Type		Propeller		Propeller	
	Motor Output	W	53		53	
Running Current (Rated)	A		5.83	7.4	7.49	9.40
Power Consumption (Rated)	W		1,320	1,690	1,710	2,160
Power Factor	%		98.4	99.3	99.3	99.9
Dimensions (HxWxD)	inch (mm)		28-15/16 x 32-1/2 x 11-13/16" (719 x 825 x 300 mm)		28-15/16 x 32-1/2 x 11-13/16" (719 x 825 x 300 mm)	
Packaged Dimensions (HxWxD)	inch (mm)		31-7/16 x 37-15/16 x 15-3/8" (799 x 964 x 391 mm)		31-7/16 x 37-15/16 x 15-3/8" (799 x 964 x 391 mm)	
Weight	Lbs (kg)		117.0 lbs (53 kg)		117.0 lbs (53 kg)	
Gross Weight	Lbs (kg)		133.0 lbs (60 kg)		133.0 lbs (60 kg)	
Operation Sound	H / L	dBA	51 / —	51 / —	51 / —	51 / —
Drawing No.			3D062874A		3D062875A	

Note: ■ The data are based on the conditions shown in the table below.

Cooling	Heating	Piping Length
Indoor ; 80°FDB/67°FWB Outdoor ; 95°FDB/75°FWB	Indoor ; 70°FDB/60°FWB Outdoor ; 47°FDB/43°FWB	25 ft (7.5 m)

Conversion Formulae
kcal/h=kW×860 Btu/h=kW×3414 cfm=m³/min×35.3

60Hz 230V

Model	Indoor Units		FTXS24HVJU	
	Outdoor Units		RX24FVJU	
			Cooling	Heating
Capacity Rated (Min.-Max.)	Btu/h	22,000 (7,500-22,000)		24,000 (7,500-25,400)
Moisture Removal	Pt/h	6.3		—
Running Current (Rated)	A	11.35		12.43
Power Consumption Rated (Min.-Max.)	W	2,600 (450-2,600)		2,850 (450-3,320)
Power Factor	%	99.6		99.7
EER (Rated)	Btu/h-W	8.5		—
COP (Rated)	W/W	—		2.47
Energy Efficiency	SEER/HSPF	13.0		7.7
Piping Connections	Liquid	inch (mm)	ϕ 1/4" (6.4 mm)	
	Gas	inch (mm)	ϕ 5/8" (15.8 mm)	
	Drain	inch (mm)	ϕ 11/16" (17.5 mm)	
Heat Insulation		Both Liquid and Gas Pipes		
Max. Interunit Piping Length	feet (m)	98.4' (30 m)		
Max. Interunit Height Difference	feet (m)	65.6' (20m)		
Chargeless	feet (m)	33' (10m)		
Amount of Additional Charge of Refrigerant	oz/ft	0.22		
Indoor Unit		FTXS24HVJU		
Front Panel Color		White		
Airflow Rate	cfm (m³/min)	H	536 (15.2)	586 (16.6)
		M	473 (13.4)	532 (15.1)
		L	409 (11.6)	477 (13.5)
Fan	Type	Cross Flow Fan		
	Motor Output	W	43	
	Speed	Steps	5 Steps, Quiet, Auto	
Air Direction Control		Right, Left, Horizontal, Downward		
Air Filter		Removable / Washable / Mildew Proof		
Running Current (Rated)	A	0.20		
Power Consumption (Rated)	W	45		
Power Factor	%	97.8		
Temperature Control		Microcomputer Control		
Dimensions (HxWxD)	inch (mm)	11-7/16 x 41-5/16 x 9-3/8" (291 x 1049 x 238 mm)		
Packaged Dimensions (HxWxD)	inch (mm)	13-1/4 x 45-3/16 x 14-7/16" (337 x 1148 x 367 mm)		
Weight	Lbs (kg)	26.5 lbs (12 kg)		
Gross Weight	Lbs (kg)	38.0 lbs (17 kg)		
Operation Sound	H/M/L	dBA	46 / 42 / 37	46 / 42 / 37
Outdoor Unit		RX24FVJU		
Casing Color		Ivory White		
Compressor	Type	Hermetically Sealed Swing Type		
	Model	2YC45EXD		
	Motor Output	W	1,900	
Refrigerant Oil	Model	FVC50K		
	Charge	oz	25.2	
Refrigerant	Model	R-410A		
	Charge	Lbs	3.75	
Airflow Rate	cfm (m³/min)	H	1,752 (49.6)	1,465 (41.5)
		L	1,529 (43.3)	1,398 (39.6)
Fan	Type	Propeller		
	Motor Output	W	53	
Running Current (Rated)	A	11.15	12.23	
Power Consumption (Rated)	W	2,555	2,805	
Power Factor	%	99.7	99.7	
Dimensions (HxWxD)	inch	28-15/16 x 32-1/2 x 11-13/16" (719 x 825 x 300 mm)		
Packaged Dimensions (HxWxD)	inch	31-7/16 x 37-15/16 x 15-3/8" (799 x 964 x 390 mm)		
Weight	Lbs	121.0 lbs (55 kg)		
Gross Weight	Lbs	137.0 lbs (62 kg)		
Operation Sound	H / L	dBA	54 / —	54 / —
Drawing No.	3D063001A			

Note: ■ The data are based on the conditions shown in the table below.

Cooling	Heating	Piping Length
Indoor ; 80°FDB/67°F WB Outdoor ; 95°FDB/75°F WB	Indoor ; 70°FDB/60°F WB Outdoor ; 47°FDB/43°F WB	25 ft (7.5 m)

Conversion Formulae
kcal/h=kWx860 Btu/h=kWx3414 cfm=m³/minx35.3

4. Dimensions

4.1 Indoor Units

FTXS09/12HVJU

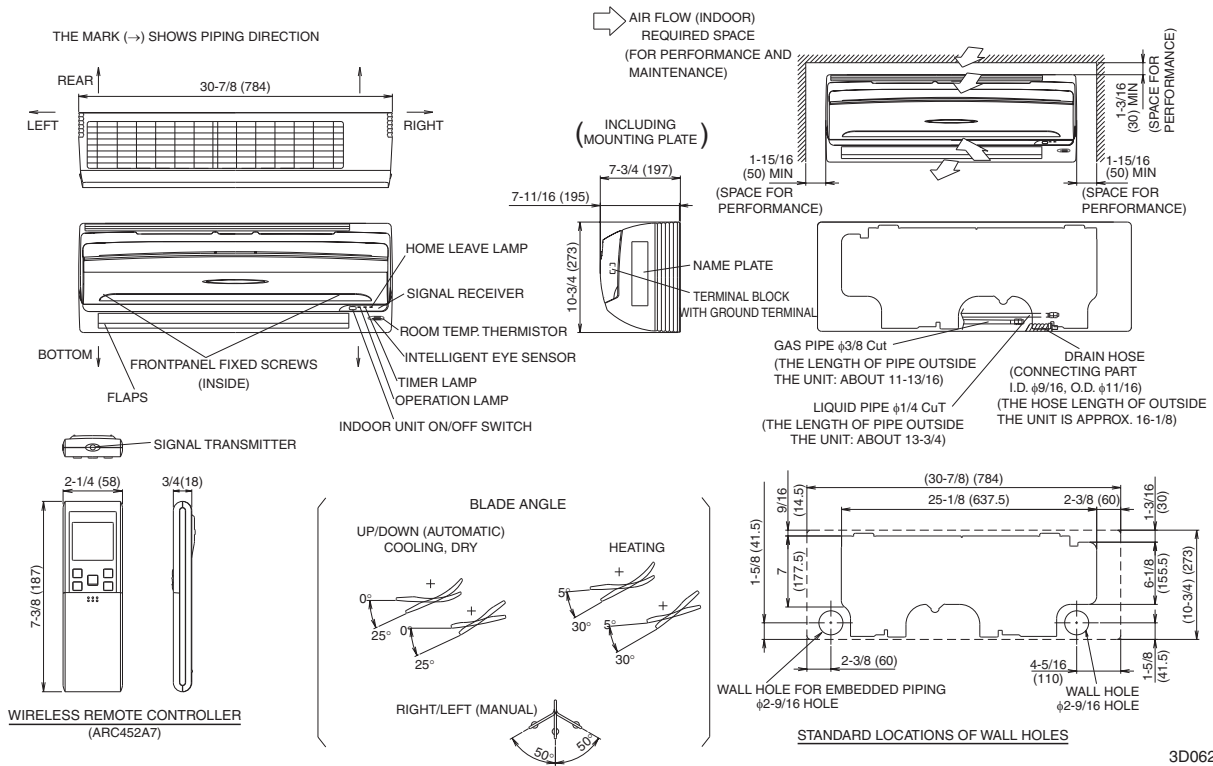

FTXS15/18HVJU

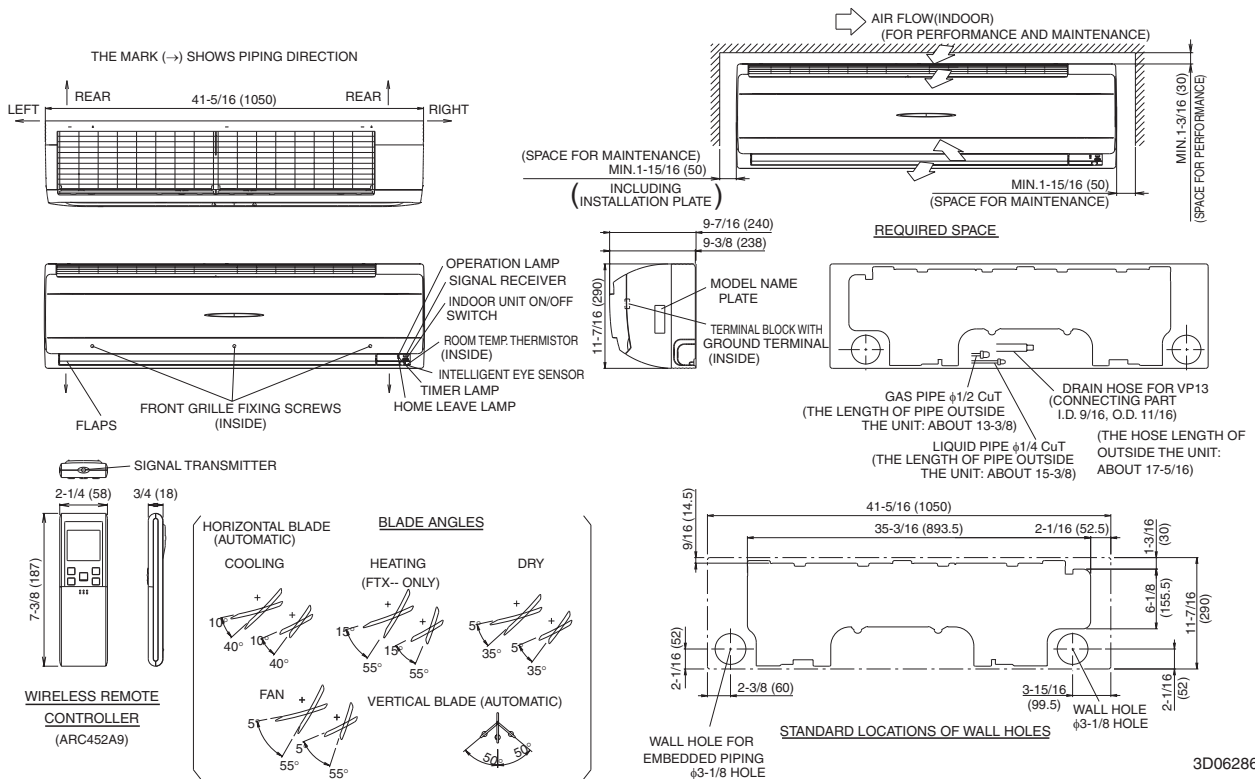

FTXS24HVJU

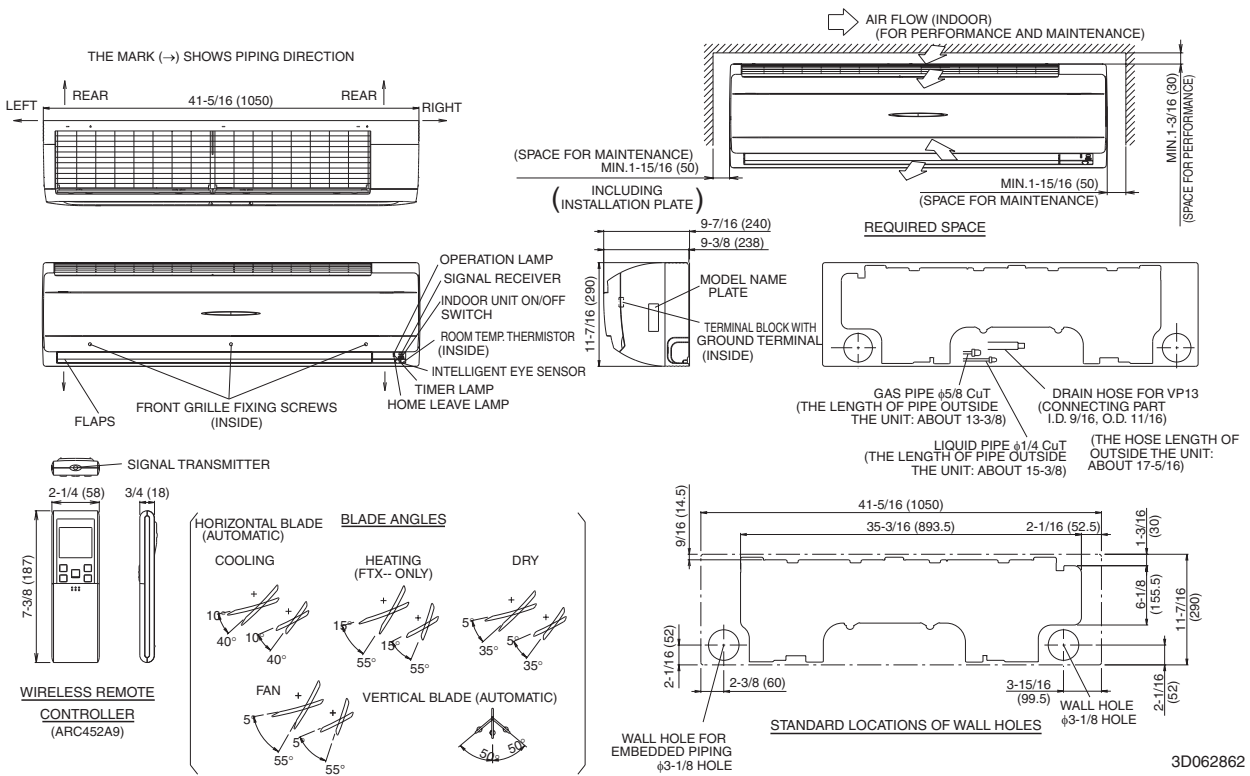

4.2 Outdoor Units

RX09/12FAVJU

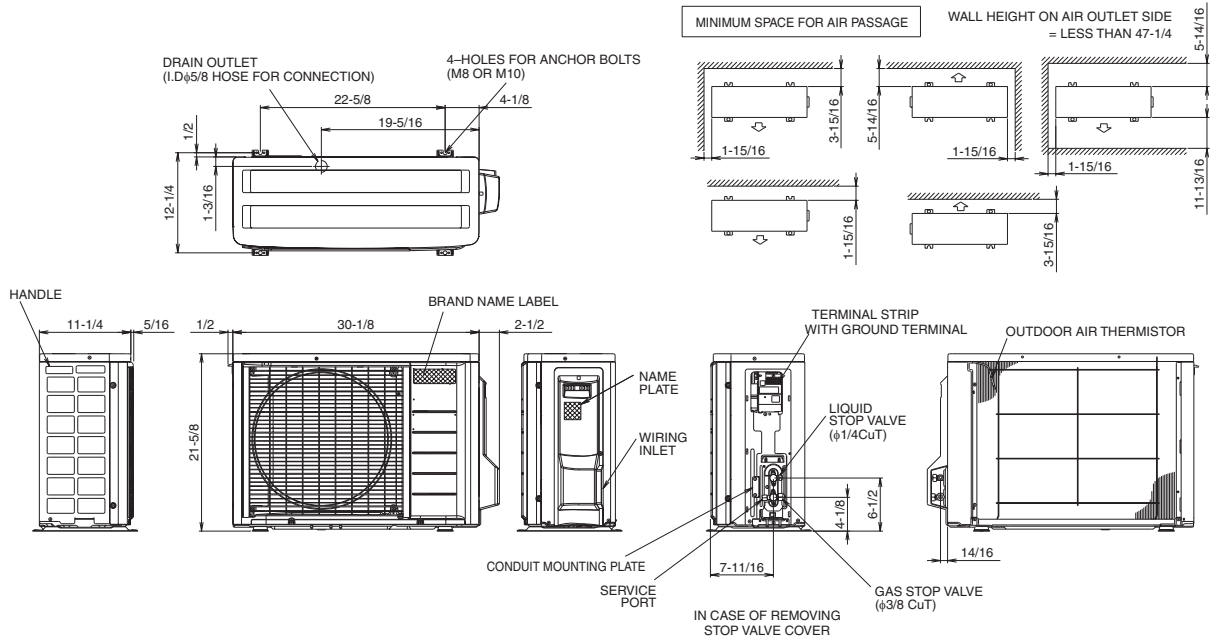

3D062757

RX15/18FVJU

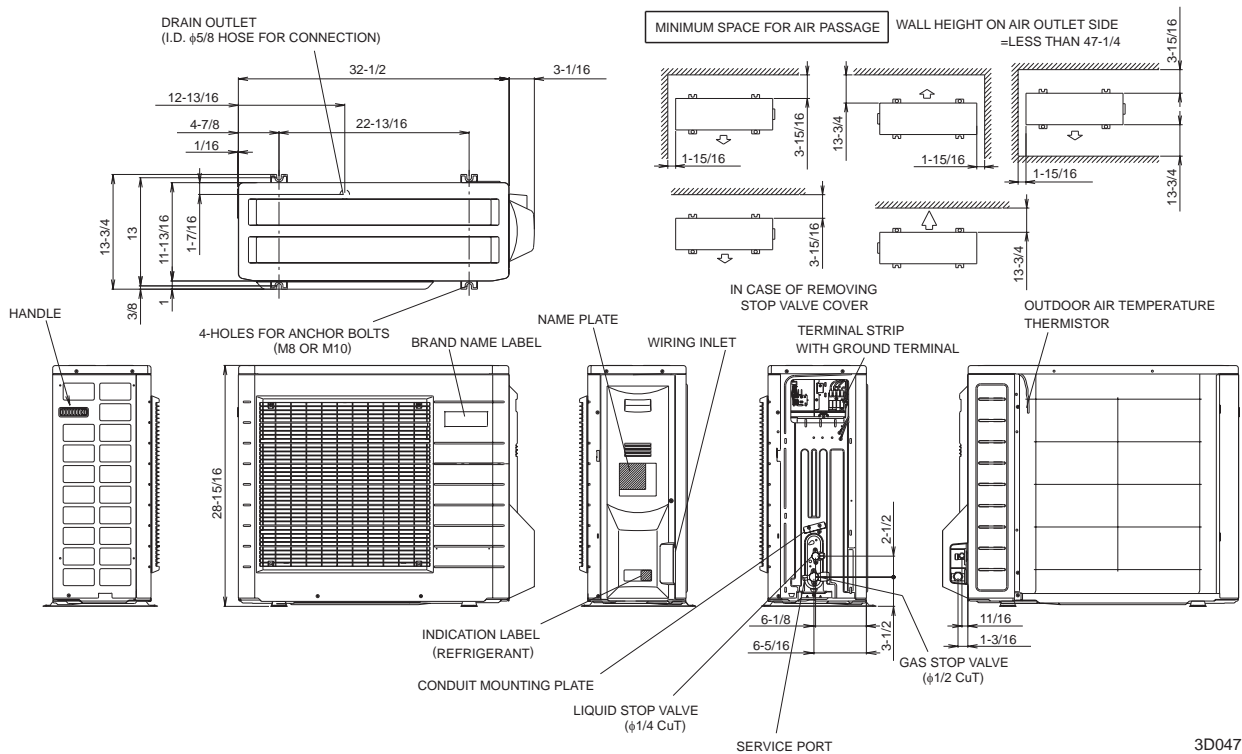

3D047140B

RX24FVJU

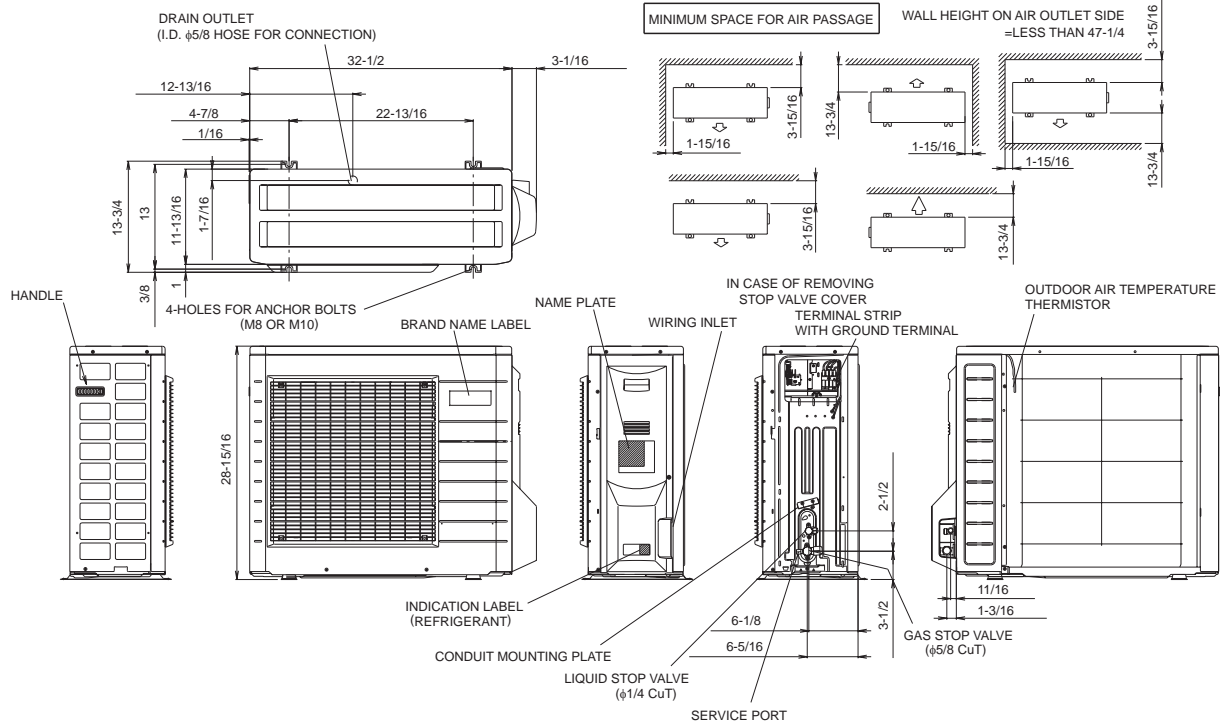

5. Wiring Diagrams

5.1 Indoor Units

FTXS09/12HVJU

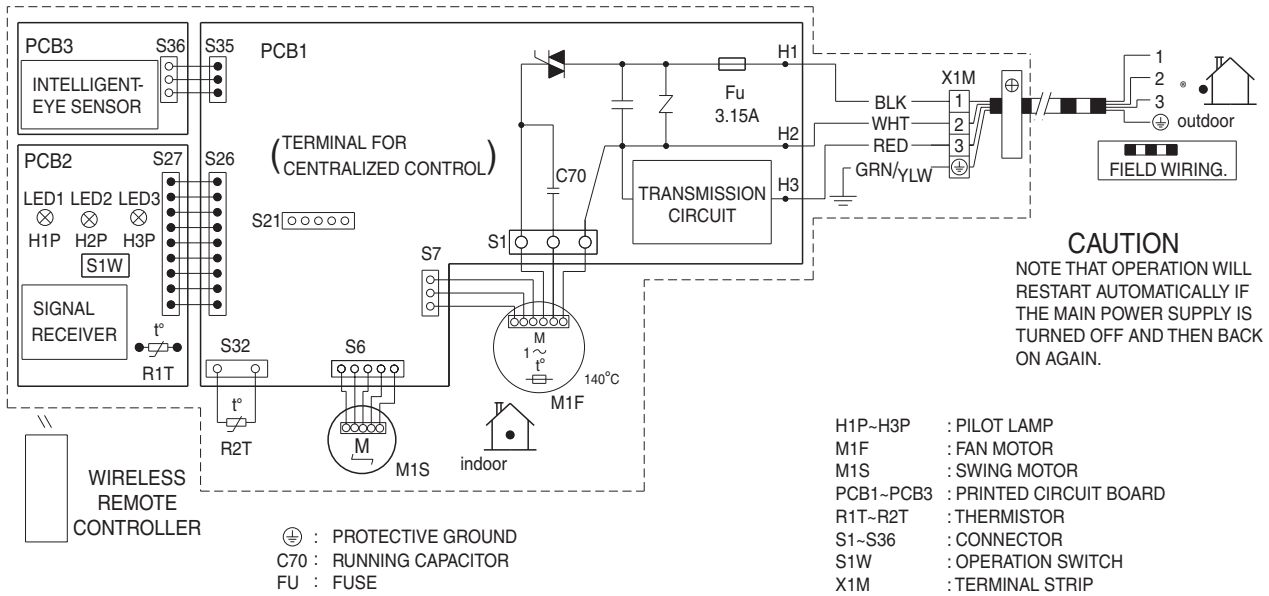

3D033599H

FTXS15/18/24HVJU

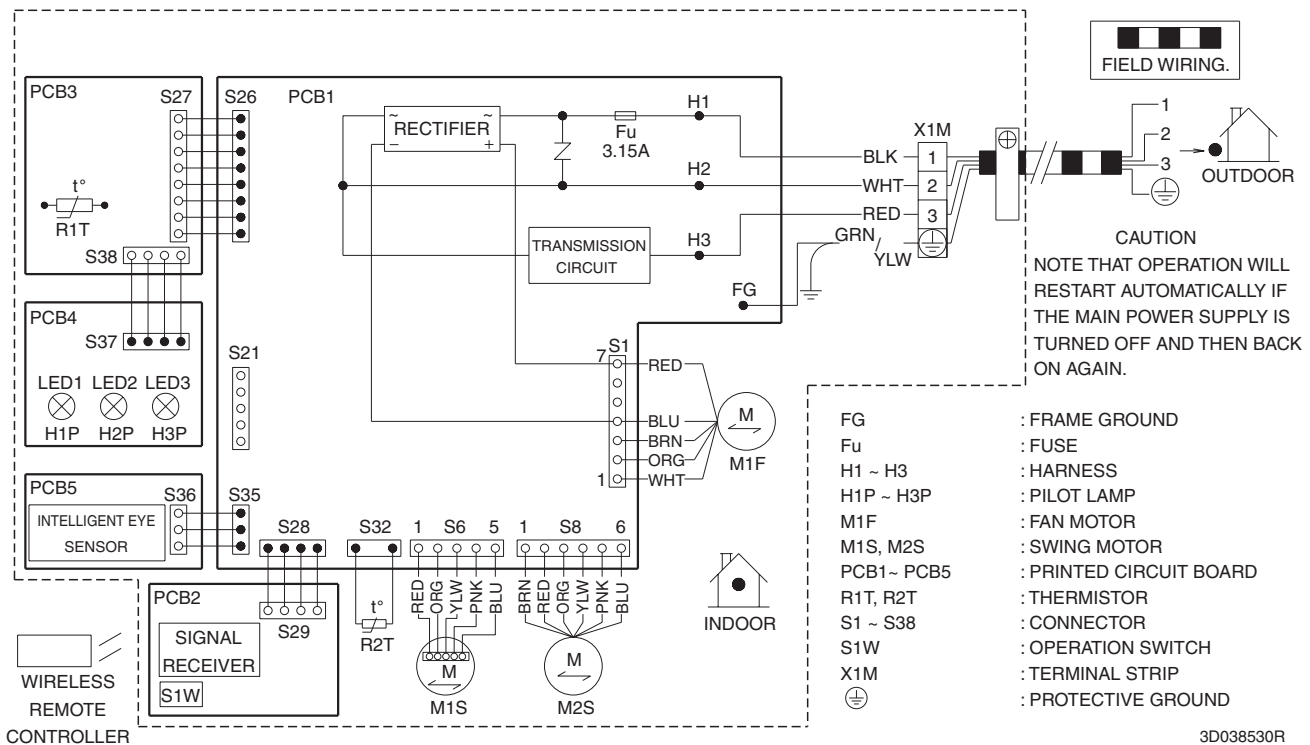

3D038530R

5.2 Outdoor Units

RX09/12FAVJU

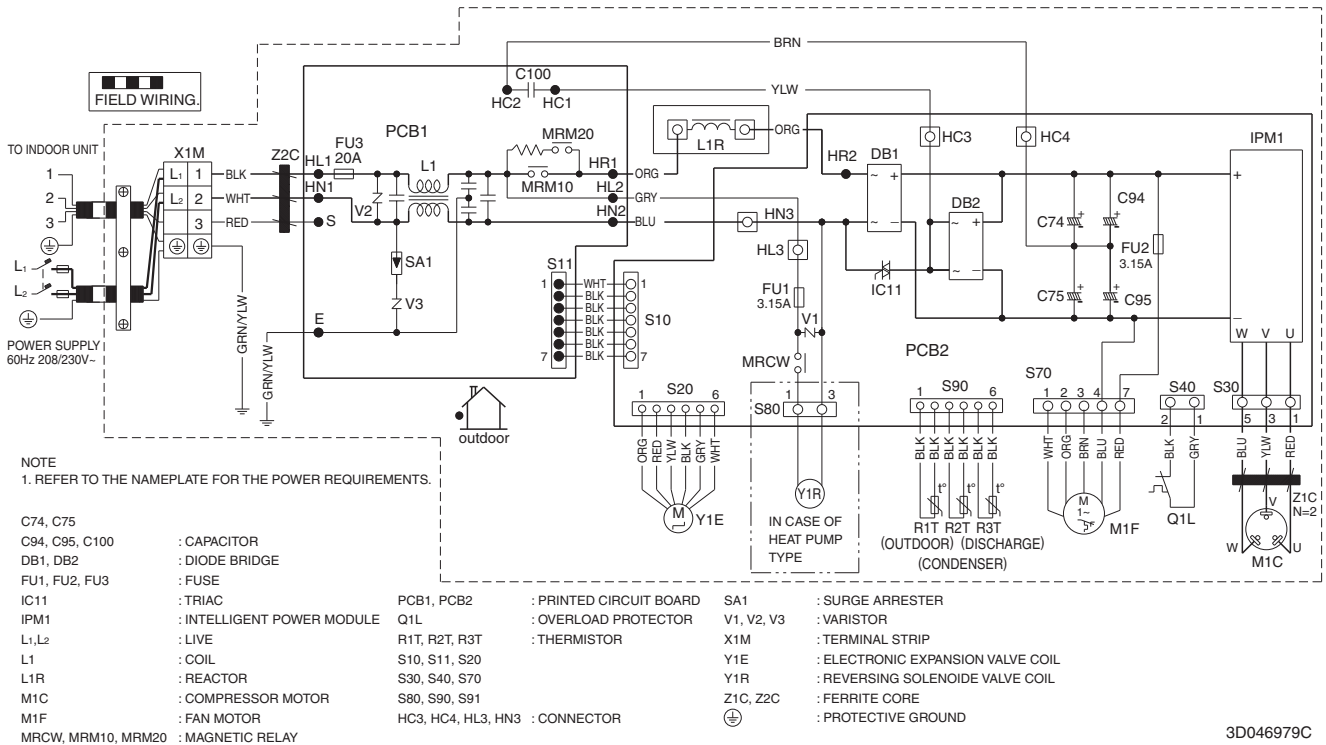

RX15/18/24FVJU

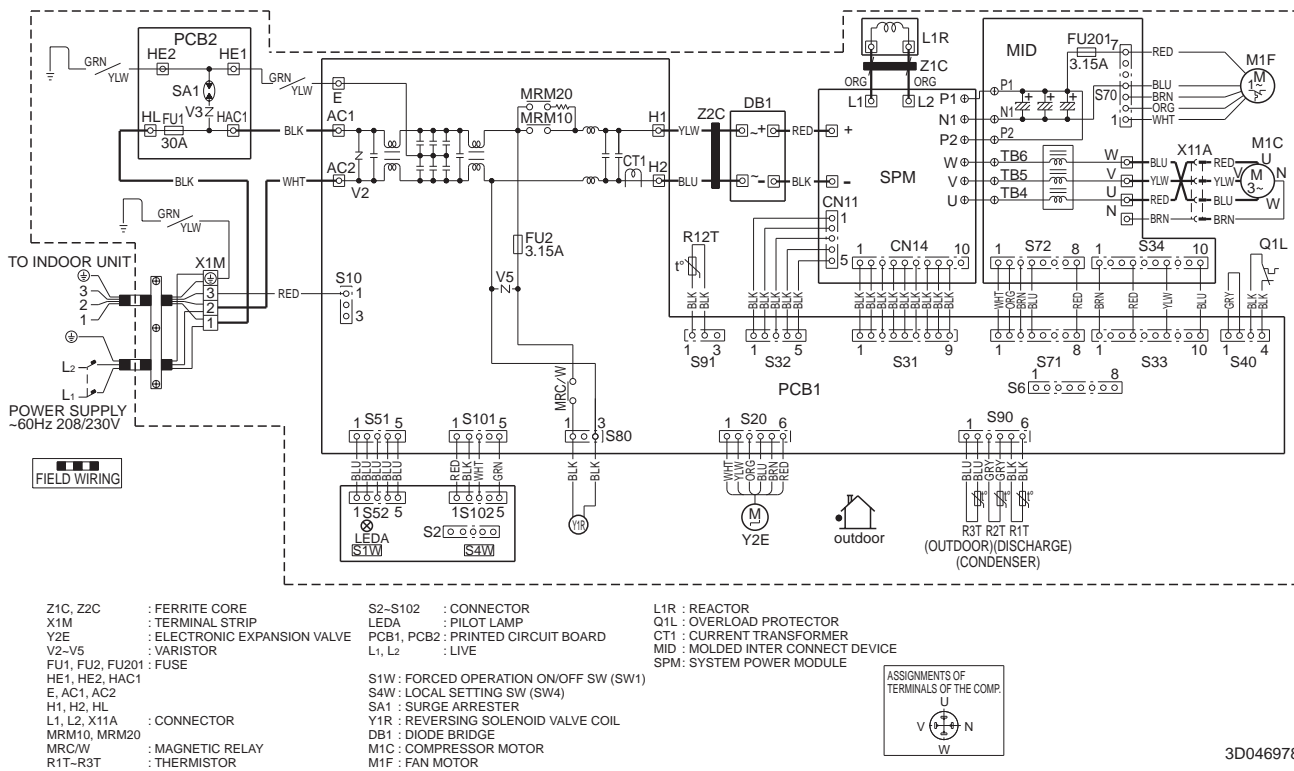

6. Piping Diagrams

6.1 Indoor Units

FTXS09/12HVJU

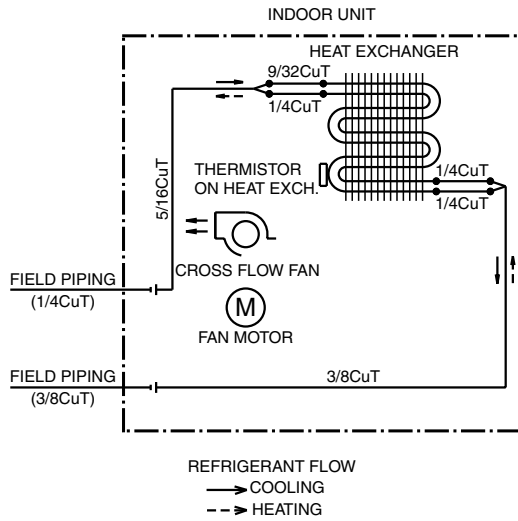

4D047158A

FTXS15/18/24HVJU

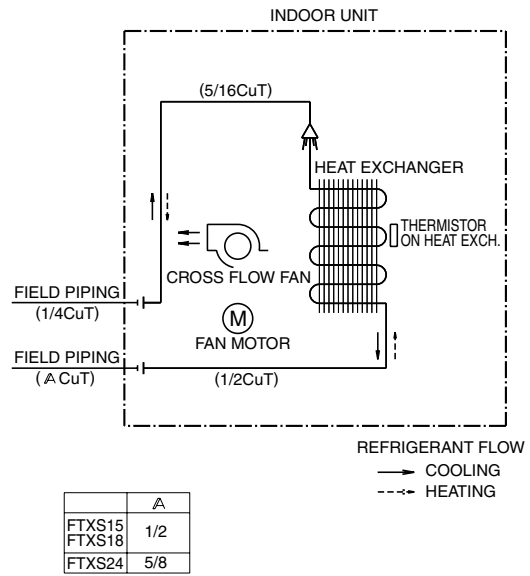

4D047162A

6.2 Outdoor Units

RX09FAVJU

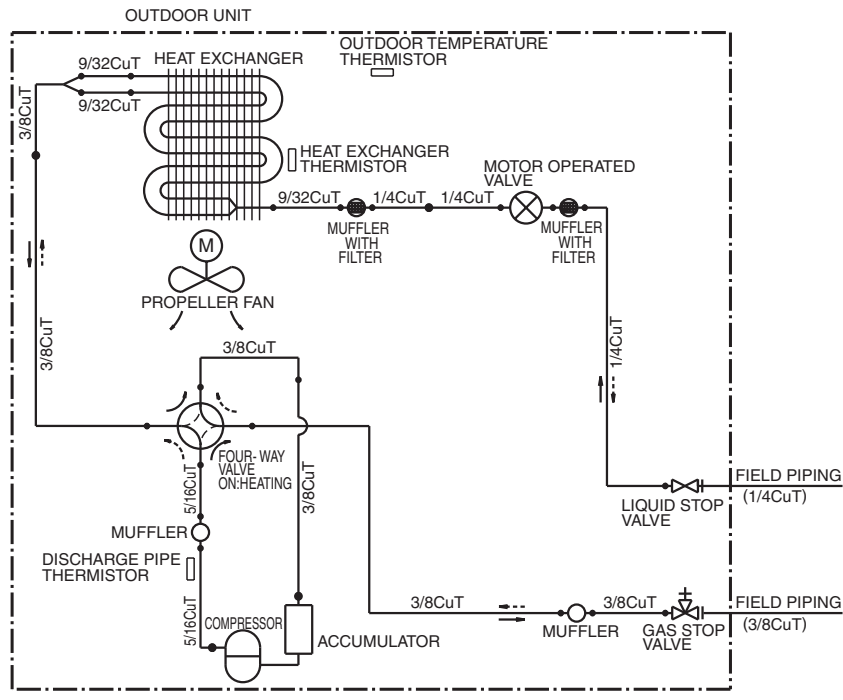

3D047143C

RX12FAVJU

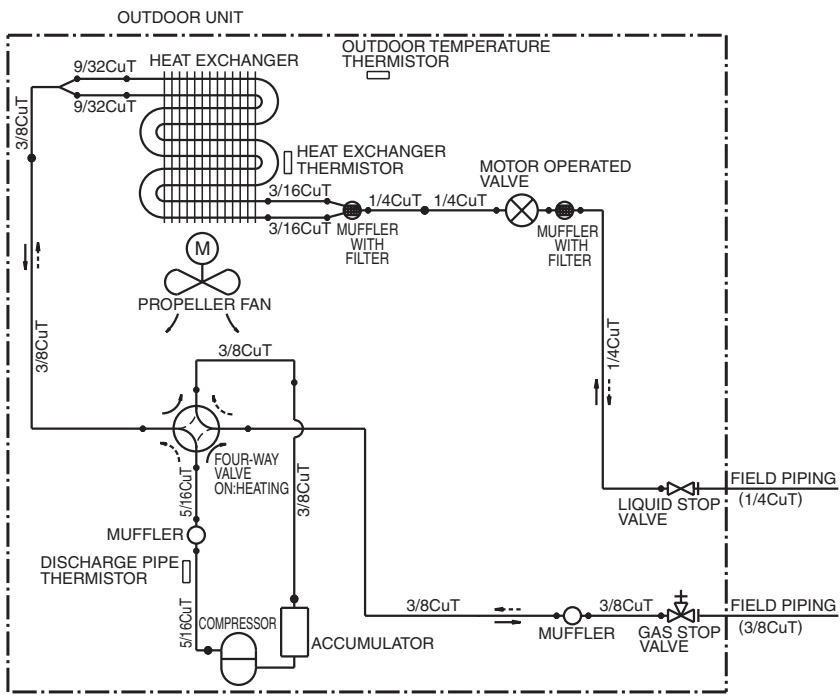

3D047142C

RX15/18FVJU

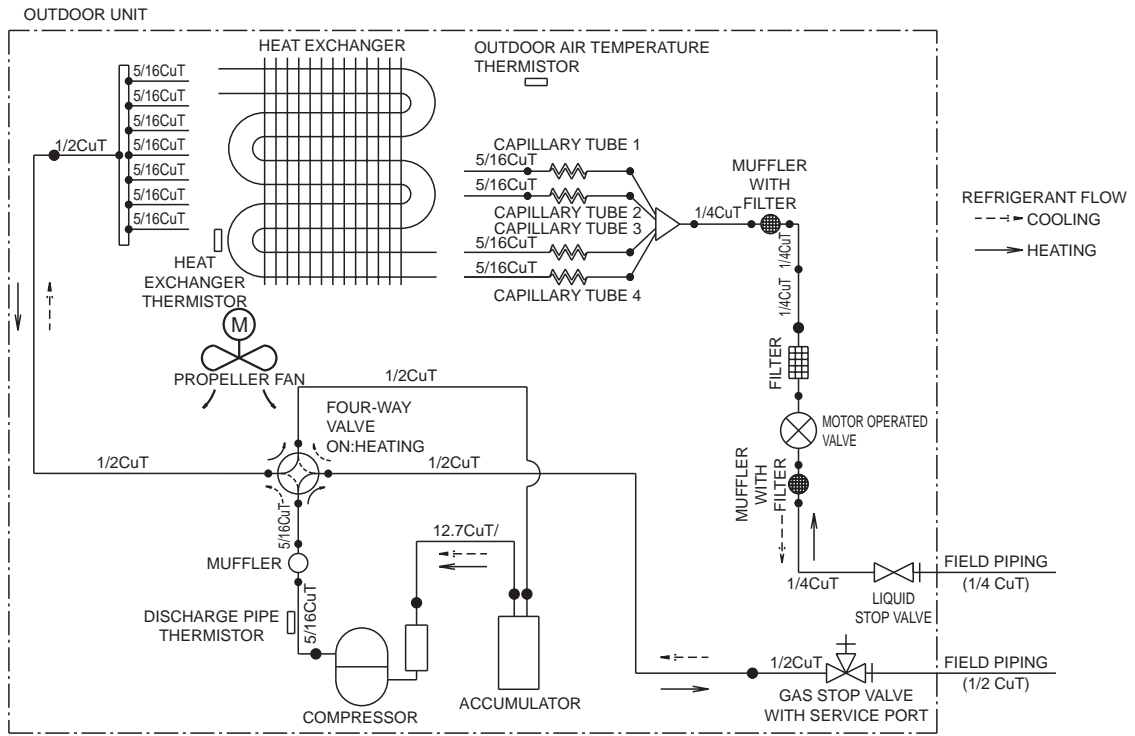

RX24FVJU

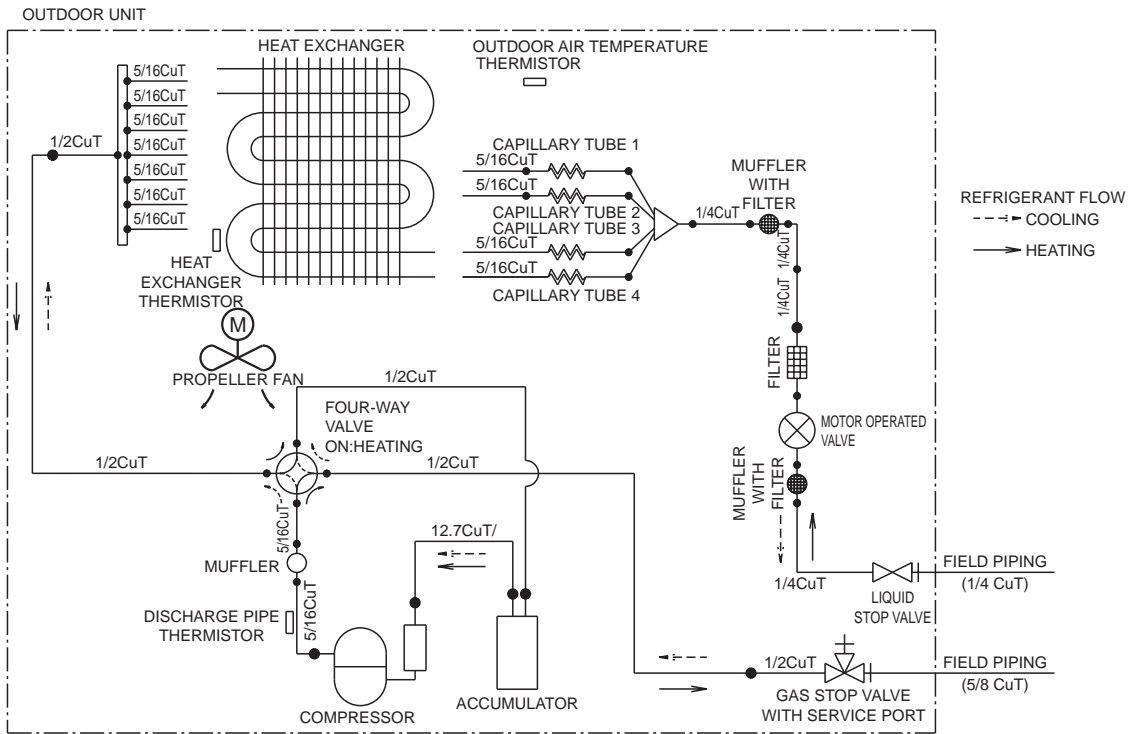

7. Capacity Tables

7.1 Heat Pump

FTXS09HVJU + RX09FAVJU (60Hz 208/230V)

Cooling

INDOOR		OUTDOOR TEMPERATURE(°FDB)																	
EWB	EDB	68.0			77.0			86.0			89.6			95.0			104.0		
		°F	°F	TC	SHC	PI	TC	SHC	PI	TC	SHC	PI	TC	SHC	PI	TC	SHC	PI	
57.2	68.0	8.67	5.68	0.71	8.27	5.46	0.76	7.88	5.24	0.81	7.72	5.14	0.83	7.48	5.01	0.86	7.08	4.79	0.92
60.8	71.6	9.13	5.87	0.71	8.73	5.65	0.76	8.33	5.43	0.81	8.18	5.34	0.83	7.94	5.21	0.86	7.54	4.99	0.91
64.4	77.0	9.52	6.02	0.70	9.13	5.81	0.75	8.73	5.59	0.80	8.57	5.52	0.83	8.33	5.38	0.86	7.93	5.16	0.91
67.0	80.0	9.72	6.10	0.70	9.32	5.89	0.75	8.92	5.67	0.80	8.77	5.58	0.82	8.50	5.44	0.85	8.13	5.24	0.91
71.6	86.0	10.31	6.33	0.70	9.91	6.12	0.75	9.51	5.91	0.80	9.35	5.82	0.82	9.12	5.69	0.85	8.72	5.48	0.90
75.2	89.6	10.70	6.46	0.69	10.30	6.27	0.74	9.91	6.06	0.79	9.75	5.97	0.81	9.51	5.85	0.84	9.11	5.64	0.89

Heating

INDOOR		OUTDOOR TEMPERATURE(°FWB)									
EDB	°F	14.0		23.0		32.0		43.0		50.0	
		TC	PI	TC	PI	TC	PI	TC	PI	TC	PI
60.8	6.20	0.97	7.51	1.01	8.83	1.05	10.40	1.10	11.45	1.13	
64.4	6.04	0.98	7.35	1.02	8.67	1.06	10.24	1.10	11.29	1.13	
68.0	5.88	0.99	7.19	1.03	8.51	1.07	10.08	1.11	11.13	1.14	
70.0	5.80	0.99	7.11	1.03	8.43	1.07	10.00	1.12	11.05	1.15	
71.6	5.72	1.00	7.03	1.04	8.34	1.07	9.92	1.12	10.97	1.15	
75.2	5.56	1.01	6.87	1.04	8.18	1.08	9.76	1.13	10.81	1.16	

Symbols

EWB	: Entering wet bulb temp.	(°F)
EDB	: Entering dry bulb temp.	(°F)
TC	: Total capacity	(kBtu/h)
SHC	: Sensible heating capacity	(kBtu/h)
PI	: Power input	(kW)

Note:

1. Ratings shown are net capacities which include a deduction for indoor fan motor heat.
2. ■ shows nominal (rated) capacities and power input.
3. TC and PI must be calculated by interpolation using the figures in the above tables. (Figures out of the tables should not be used for calculation.)
4. Capacities are based on the following conditions.
Corresponding refrigerant piping length : 25ft
Level difference : 0ft

3D057579A

FTXS12HVJU + RX12FAVJU (60Hz 208/230V)

Cooling

INDOOR		OUTDOOR TEMPERATURE(°FDB)																	
EWB	EDB	68.0			77.0			86.0			89.6			95.0			104.0		
°F	°F	TC	SHC	PI	TC	SHC	PI	TC	SHC	PI	TC	SHC	PI	TC	SHC	PI	TC	SHC	PI
57.2	68.0	13.03	8.54	1.09	12.49	8.31	1.17	11.95	7.95	1.25	11.74	7.83	1.28	11.42	7.65	1.33	10.88	7.35	1.41
60.8	71.6	13.09	8.41	1.10	12.55	8.18	1.18	12.01	7.83	1.26	11.79	7.71	1.29	11.47	7.53	1.34	10.93	7.23	1.42
64.4	77.0	13.16	8.33	1.11	12.63	8.09	1.19	12.09	7.75	1.27	11.87	7.64	1.30	11.07	7.14	1.35	11.01	7.15	1.43
67.0	80.0	13.12	8.24	1.11	12.58	8.00	1.19	12.04	7.65	1.27	11.82	7.53	1.30	11.50	7.36	1.35	10.96	7.06	1.43
71.6	86.0	13.30	8.16	1.12	12.76	7.92	1.20	12.22	7.58	1.28	12.00	7.46	1.31	11.68	7.29	1.36	11.14	7.00	1.44
75.2	89.6	13.35	8.06	1.12	12.81	7.84	1.20	12.27	7.51	1.28	12.06	7.39	1.31	11.50	7.07	1.36	11.19	6.92	1.44

Heating

INDOOR		OUTDOOR TEMPERATURE(°FWB)									
EDB		14.0		23.0		32.0		43.0		50.0	
°F		TC	PI	TC	PI	TC	PI	TC	PI	TC	PI
60.8		6.65	0.92	8.19	0.97	9.73	1.02	11.58	1.07	12.82	1.11
64.4		6.61	0.93	8.15	0.98	9.70	1.03	11.55	1.08	12.78	1.12
68.0		6.58	0.94	8.12	0.99	9.66	1.04	11.52	1.09	12.75	1.13
70.0		6.56	0.95	8.10	0.99	9.65	1.04	11.50	1.10	12.73	1.14
71.6		6.54	0.95	8.09	1.00	9.63	1.05	11.48	1.10	12.71	1.14
75.2		6.51	0.96	8.05	1.01	9.59	1.06	11.45	1.11	12.68	1.15

Symbols

EWB	: Entering wet bulb temp.	(°F)
EDB	: Entering dry bulb temp.	(°F)
TC	: Total capacity	(kBtu/h)
SHC	: Sensible heating capacity	(kBtu/h)
PI	: Power input	(kW)

Note:

1. Ratings shown are net capacities which include a deduction for indoor fan motor heat.
2. ■ shows nominal (rated) capacities and power input.
3. TC and PI must be calculated by interpolation using the figures in the above tables. (Figures out of the tables should not be used for calculation.)
4. Capacities are based on the following conditions.
Corresponding refrigerant piping length : 25ft
Level difference : 0ft

3D057580A

FTXS15HVJU + RX15FVJU (60Hz 208/230V)

Cooling

INDOOR		OUTDOOR TEMPERATURE(°FDB)																	
EWB	EDB	68.0			77.0			86.0			89.6			95.0			104.0		
°F	°F	TC	SHC	PI	TC	SHC	PI	TC	SHC	PI	TC	SHC	PI	TC	SHC	PI	TC	SHC	PI
57.2	68.0	15.05	9.86	1.00	14.54	9.67	1.09	14.02	9.33	1.19	13.82	9.21	1.22	13.51	9.06	1.28	13.00	8.79	1.38
60.8	71.6	15.47	9.95	1.02	14.96	9.75	1.11	14.45	9.42	1.21	14.24	9.31	1.25	13.94	9.15	1.30	13.43	8.89	1.40
64.4	77.0	16.11	10.19	1.05	15.60	10.00	1.14	15.09	9.67	1.24	14.88	9.58	1.28	14.58	9.40	1.33	14.06	9.14	1.43
67.0	80.0	16.54	10.38	1.07	16.02	10.19	1.17	15.51	9.86	1.26	15.31	9.75	1.30	15.00	9.60	1.36	14.49	9.34	1.45
71.6	86.0	17.17	10.54	1.10	16.66	10.34	1.20	16.15	10.02	1.29	15.94	9.92	1.33	15.64	9.76	1.39	15.13	9.50	1.48
75.2	89.6	17.60	10.62	1.12	17.09	10.45	1.22	16.57	10.14	1.31	16.37	10.03	1.35	16.06	9.88	1.41	15.55	9.62	1.50

Heating

INDOOR		OUTDOOR TEMPERATURE(°FWB)									
EDB		14.0		23.0		32.0		43.0		50.0	
°F		TC	PI	TC	PI	TC	PI	TC	PI	TC	PI
60.8		8.42	1.22	11.32	1.32	14.22	1.42	17.70	1.54	20.02	1.62
64.4		8.54	1.30	11.44	1.40	14.34	1.50	17.82	1.62	20.14	1.70
68.0		8.66	1.37	11.56	1.47	14.46	1.57	17.94	1.69	20.26	1.77
70.0		8.72	1.41	11.62	1.51	14.52	1.61	18.00	1.73	20.32	1.81
71.6		8.78	1.45	11.68	1.55	14.58	1.65	18.06	1.77	20.38	1.85
75.2		8.90	1.52	11.80	1.62	14.70	1.72	18.18	1.84	20.50	1.93

Symbols

EWB	: Entering wet bulb temp.	(°F)
EDB	: Entering dry bulb temp.	(°F)
TC	: Total capacity	(kBtu/h)
SHC	: Sensible heating capacity	(kBtu/h)
PI	: Power input	(kW)

Note:

1. Ratings shown are net capacities which include a deduction for indoor fan motor heat.
2. ■ shows nominal (rated) capacities and power input.
3. TC and PI must be calculated by interpolation using the figures in the above tables. (Figures out of the tables should not be used for calculation.)
4. Capacities are based on the following conditions.
Corresponding refrigerant piping length : 25ft
Level difference : 0ft

3D057581A

FTXS18HVJU + RX18FVJU (60Hz 208/230V)

Cooling

INDOOR		OUTDOOR TEMPERATURE(°FDB)																	
EWB	EDB	68.0			77.0			86.0			89.6			95.0			104.0		
°F	°F	TC	SHC	PI	TC	SHC	PI	TC	SHC	PI	TC	SHC	PI	TC	SHC	PI	TC	SHC	PI
57.2	68.0	18.05	11.82	1.39	17.54	11.66	1.49	17.02	11.32	1.58	16.82	11.21	1.62	16.51	11.07	1.68	16.00	10.81	1.77
60.8	71.6	18.47	11.88	1.41	17.96	11.71	1.51	17.45	11.38	1.60	17.24	11.27	1.64	16.94	11.13	1.70	16.43	10.87	1.79
64.4	77.0	19.11	12.09	1.44	18.60	11.92	1.54	18.09	11.59	1.63	17.88	11.51	1.67	17.58	11.34	1.73	17.06	11.09	1.82
67.0	80.0	19.54	12.27	1.47	19.02	12.09	1.56	18.51	11.77	1.66	18.31	11.66	1.69	18.00	11.52	1.75	17.49	11.27	1.85
71.6	86.0	20.17	12.38	1.50	19.66	12.20	1.59	19.15	11.89	1.69	18.94	11.78	1.72	18.64	11.64	1.78	18.13	11.39	1.88
75.2	89.6	20.60	12.43	1.52	20.09	12.29	1.61	19.57	11.97	1.71	19.37	11.87	1.75	19.06	11.72	1.80	18.55	11.48	1.90

Heating

INDOOR		OUTDOOR TEMPERATURE(°FWB)									
EDB		14.0		23.0		32.0		43.0		50.0	
°F		TC	PI	TC	PI	TC	PI	TC	PI	TC	PI
60.8		12.02	1.69	14.92	1.79	17.82	1.89	21.30	2.01	23.62	1.89
64.4		12.14	1.77	15.04	1.87	17.94	1.97	21.42	2.09	23.74	1.97
68.0		12.26	1.84	15.16	1.94	18.06	2.04	21.54	2.16	23.86	2.04
70.0		12.32	1.88	15.22	1.98	18.12	2.08	21.60	2.20	23.92	2.08
71.6		12.38	1.92	15.28	2.02	18.18	2.12	21.66	2.24	23.98	2.12
75.2		12.50	1.99	15.40	2.09	18.30	2.19	21.78	2.31	24.10	2.20

Symbols

EWB	: Entering wet bulb temp.	(°F)
EDB	: Entering dry bulb temp.	(°F)
TC	: Total capacity	(kBtu/h)
SHC	: Sensible heating capacity	(kBtu/h)
PI	: Power input	(kW)

Note:

1. Ratings shown are net capacities which include a deduction for indoor fan motor heat.
2. ■ shows nominal (rated) capacities and power input.
3. TC and PI must be calculated by interpolation using the figures in the above tables. (Figures out of the tables should not be used for calculation.)
4. Capacities are based on the following conditions.
Corresponding refrigerant piping length : 25ft
Level difference : 0ft

3D057582A

FTXS24HVJU + RX24FVJU (60Hz 208/230V)

Cooling

INDOOR		OUTDOOR TEMPERATURE(°FDB)																	
EWB	EDB	68.0			77.0			86.0			89.6			95.0			104.0		
°F	°F	TC	SHC	PI	TC	SHC	PI	TC	SHC	PI	TC	SHC	PI	TC	SHC	PI	TC	SHC	PI
57.2	68.0	22.05	14.16	2.24	21.54	14.32	2.33	21.02	13.98	2.43	20.82	13.88	2.46	20.51	13.75	2.52	20.00	13.52	2.62
60.8	71.6	22.47	14.45	2.26	21.96	14.32	2.35	21.45	13.99	2.45	21.24	13.89	2.49	20.94	13.75	2.54	20.43	13.52	2.64
64.4	77.0	23.11	14.62	2.29	22.60	14.48	2.38	22.09	14.15	2.48	21.88	14.09	2.52	21.58	13.92	2.57	21.06	13.69	2.67
67.0	80.0	23.54	14.78	2.31	23.02	14.64	2.41	22.51	14.31	2.50	22.31	14.21	2.54	22.00	14.08	2.60	21.49	13.85	2.69
71.6	86.0	24.17	14.84	2.34	23.66	14.69	2.44	23.15	14.37	2.53	22.94	14.27	2.57	22.64	14.14	2.63	22.13	13.90	2.72
75.2	89.6	24.60	14.85	2.36	24.09	14.73	2.46	23.57	14.42	2.55	23.37	14.32	2.59	23.06	14.18	2.65	22.55	13.95	2.74

Heating

INDOOR		OUTDOOR TEMPERATURE(°FWB)									
EDB		14.0		23.0		32.0		43.0		50.0	
°F		TC	PI	TC	PI	TC	PI	TC	PI	TC	PI
60.8		14.42	2.34	17.32	2.44	20.22	2.54	23.70	2.66	26.02	2.74
64.4		14.54	2.42	17.44	2.52	20.34	2.62	23.82	2.74	26.14	2.82
68.0		14.66	2.49	17.56	2.59	20.46	2.69	23.94	2.81	26.26	2.89
70.0		14.72	2.53	17.62	2.63	20.52	2.73	24.00	2.85	26.32	2.93
71.6		14.78	2.57	17.68	2.67	20.58	2.77	24.06	2.89	26.38	2.97
75.2		14.90	2.64	17.80	2.74	20.70	2.84	24.18	2.96	26.50	3.05

Symbols

EWB	: Entering wet bulb temp.	(°F)
EDB	: Entering dry bulb temp.	(°F)
TC	: Total capacity	(kBtu/h)
SHC	: Sensible heating capacity	(kBtu/h)
PI	: Power input	(kW)

Note:

1. Ratings shown are net capacities which include a deduction for indoor fan motor heat.
2. ■ shows nominal (rated) capacities and power input.
3. TC and PI must be calculated by interpolation using the figures in the above tables. (Figures out of the tables should not be used for calculation.)
4. Capacities are based on the following conditions.
Corresponding refrigerant piping length : 25ft
Level difference : 0ft

3D057583A

7.2 Capacity correction factor by the length of refrigerant piping (Reference)

The cooling and the heating capacity of the unit has to be corrected in accordance with the length of refrigerant piping. (The distance between the indoor unit and the outdoor unit)

<— line : cooling capacity>

<--- line : heating capacity>

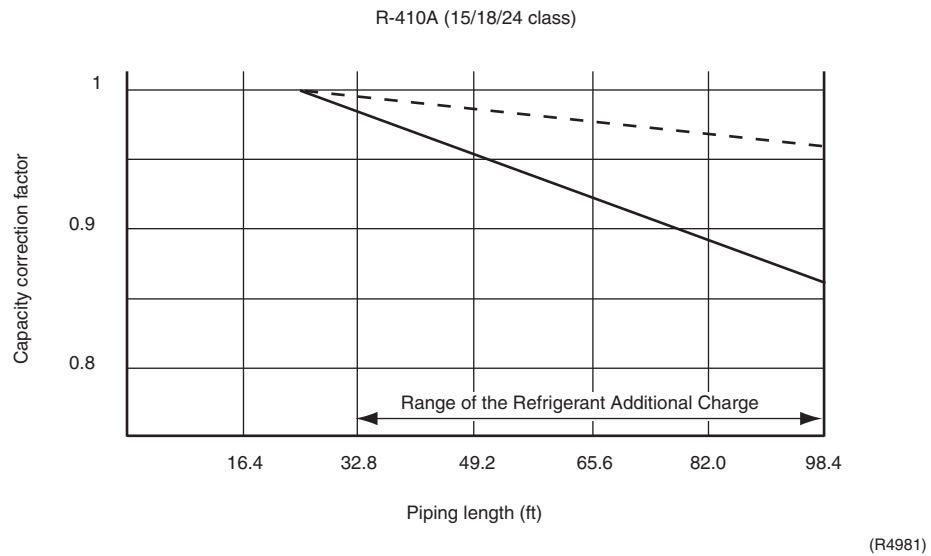
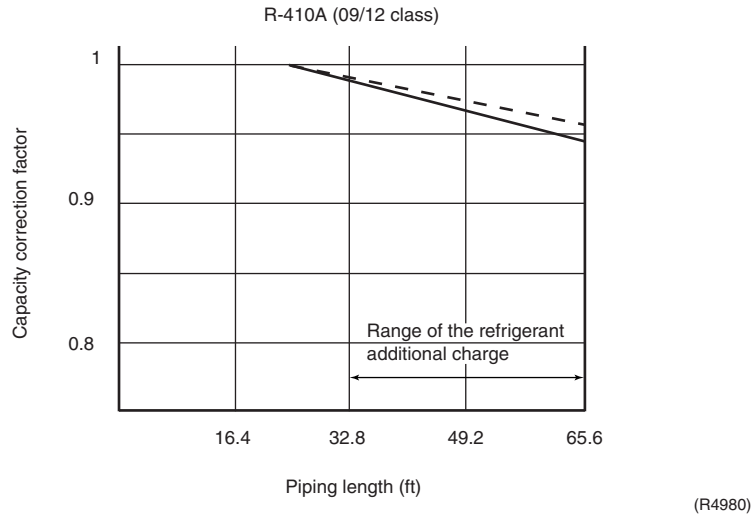

Note: The graphs show the factor when additional refrigerant of the proper quantity is charged.

8. Operation Limit

RX09/12FAVJU, RX15/18/24FVJU

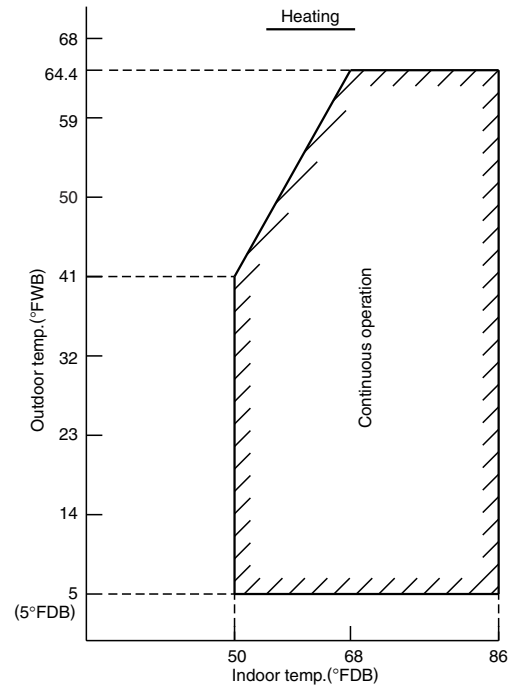
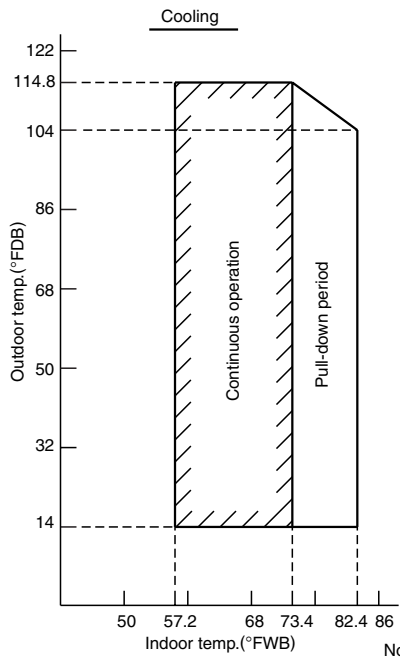

Notes:
 The graphs are based on the following conditions.
 • Equivalent piping length 25ft
 • Level difference 0ft
 • Air flow rate High

3D047649C

9. Sound Level

9.1 Measuring Location

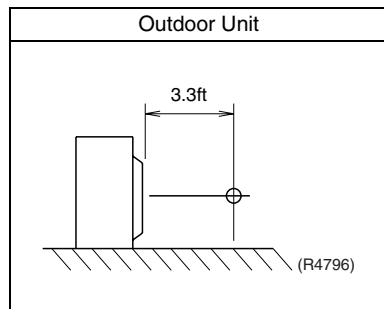
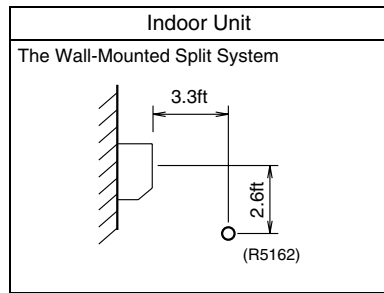

- Note:**
1. Operation sound is measured in an anechoic chamber.
 2. The data are based on the conditions shown in the table below.

Cooling	Heating	Piping Length
Indoor ; 80°FDB/67°FWB Outdoor ; 95°FDB/75°FWB	Indoor ; 70°FDB/60°FWB Outdoor ; 47°FDB/43°FWB	25ft

9.2 Octave Band Level

9.2.1 Indoor Units

FTXS09HVJU

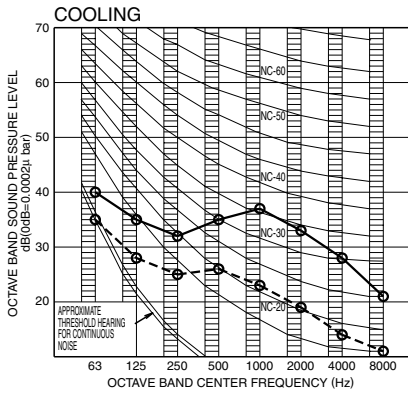

OVER ALL (dB)		
SCALE	60Hz 208/230V (H)	60Hz 208/230V (L)
A	38	25

(B.G.N IS ALREADY RECTIFIED)

OPERATING CONDITIONS

POWER SOURCE 208/230V 60Hz

JIS STANDARD

STANDARD EXTERNAL STATIC PRESSURE

○—○ 60Hz 208/230V(H)

○- -○ 60Hz 208/230V(L)

Cooling

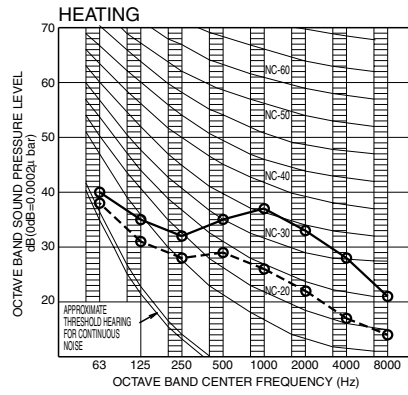

OVER ALL (dB)		
SCALE	60Hz 208/230V (H)	60Hz 208/230V (L)
A	38	28

(B.G.N IS ALREADY RECTIFIED)

OPERATING CONDITIONS

POWER SOURCE 208/230V 60Hz

JIS STANDARD

STANDARD EXTERNAL STATIC PRESSURE

○—○ 60Hz 208/230V(H)

○- -○ 60Hz 208/230V(L)

Heating

3D047160A

FTXS12HVJU

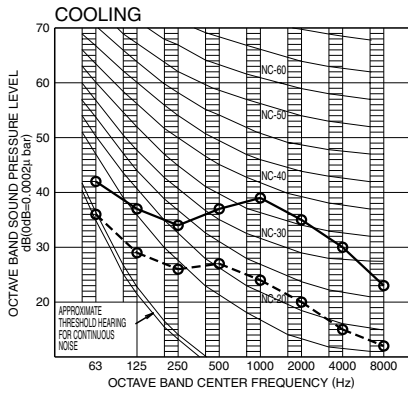

OVER ALL (dB)		
SCALE	60Hz 208/230V (H)	60Hz 208/230V (L)
A	40	26

(B.G.N IS ALREADY RECTIFIED)

OPERATING CONDITIONS

POWER SOURCE 208/230V 60Hz

JIS STANDARD

STANDARD EXTERNAL STATIC PRESSURE

○—○ 60Hz 208/230V(H)

○- -○ 60Hz 208/230V(L)

Cooling

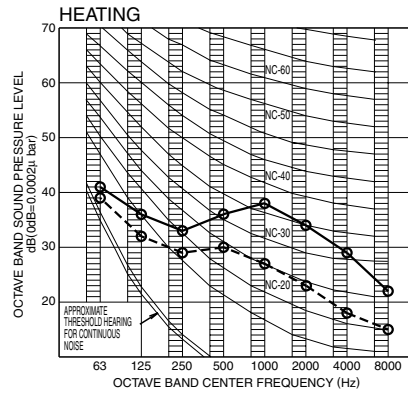

OVER ALL (dB)		
SCALE	60Hz 208/230V (H)	60Hz 208/230V (L)
A	39	29

(B.G.N IS ALREADY RECTIFIED)

OPERATING CONDITIONS

POWER SOURCE 208/230V 60Hz

JIS STANDARD

STANDARD EXTERNAL STATIC PRESSURE

○—○ 60Hz 208/230V(H)

○- -○ 60Hz 208/230V(L)

Heating

3D047170A

FTXS15/18HVJU

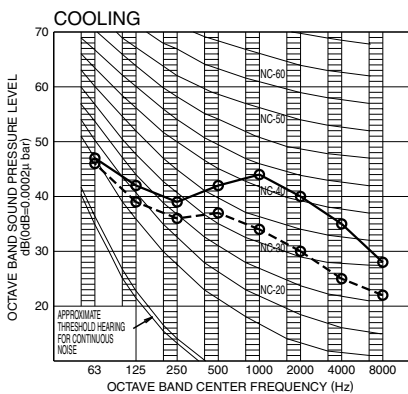

OVER ALL (dB)		
SCALE	60Hz 208/230V (H)	60Hz 208/230V (L)
A	45	36

(B.G.N IS ALREADY RECTIFIED)

OPERATING CONDITIONS

POWER SOURCE 208/230V 60Hz

JIS STANDARD

STANDARD EXTERNAL STATIC PRESSURE

○—○ 60Hz 208/230V(H)

○- -○ 60Hz 208/230V(L)

Cooling

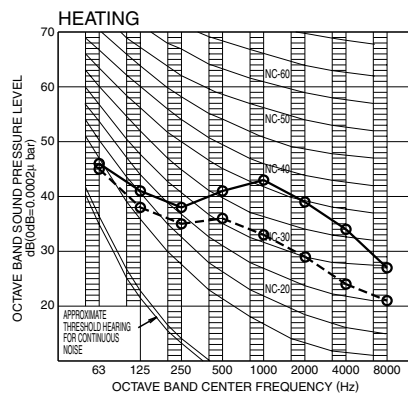

OVER ALL (dB)		
SCALE	60Hz 208/230V (H)	60Hz 208/230V (L)
A	44	35

(B.G.N IS ALREADY RECTIFIED)

OPERATING CONDITIONS

POWER SOURCE 208/230V 60Hz

JIS STANDARD

STANDARD EXTERNAL STATIC PRESSURE

○—○ 60Hz 208/230V(H)

○- -○ 60Hz 208/230V(L)

Heating

3D047167A

FTXS24HVJU

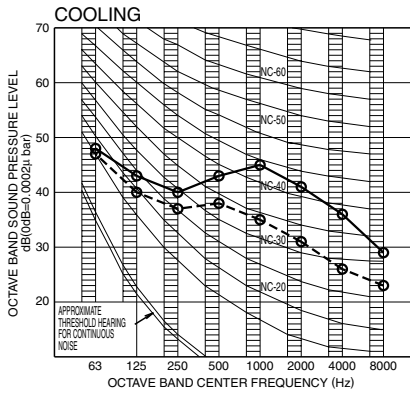

OVER ALL (dB)

SCALE	60Hz 208/230V (H)	60Hz 208/230V (L)
A	46	37

(B.G.N IS ALREADY RECTIFIED)

OPERATING CONDITIONS

POWER SOURCE 208/230V 60Hz

JIS STANDARD

○—○ 60Hz 208/230V(H)
○- -○ 60Hz 208/230V(L)

Cooling

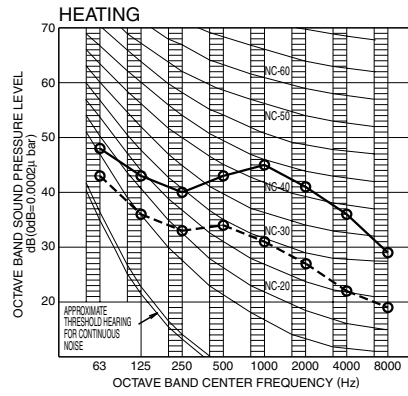

OVER ALL (dB)

SCALE	60Hz 208/230V (H)	60Hz 208/230V (L)
A	46	37

(B.G.N IS ALREADY RECTIFIED)

OPERATING CONDITIONS

POWER SOURCE 208/230V 60Hz

JIS STANDARD

○—○ 60Hz 208/230V(H)
○- -○ 60Hz 208/230V(L)

Heating

3D047171A

9.2.2 Outdoor Units

RX09FAVJU

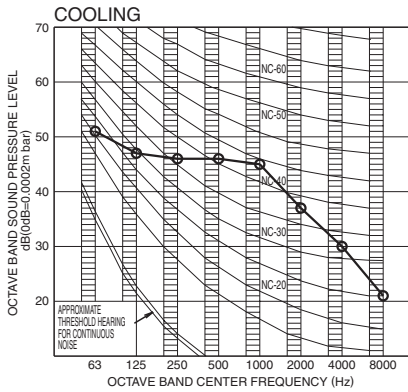

OVERALL (dB)	
SCALE	60Hz 208/230V(H)
A	48
(B.G.N IS ALREADY RECTIFIED)	
OPERATING CONDITIONS	
POWER SOURCE	208/230V 60Hz
JIS STANDARD	
○	60Hz 208/230V
○	Cooling

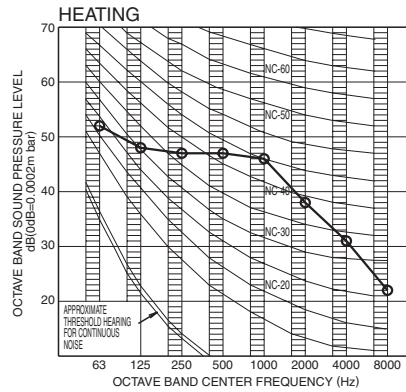

OVER ALL (dB)	
SCALE	60Hz 208/230V(H)
A	49
(B.G.N IS ALREADY RECTIFIED)	
OPERATING CONDITIONS	
POWER SOURCE	208/230V 60Hz
JIS STANDARD	
○	60Hz 208/230V
○	Heating

3D047644B

RX12FAVJU

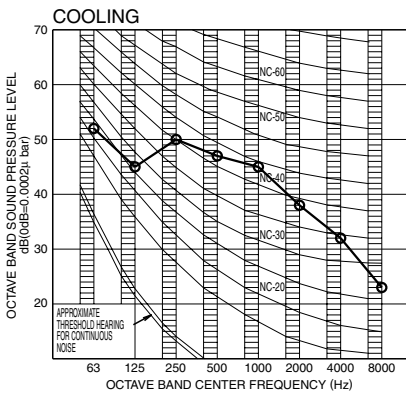

OVER ALL (dB)	
SCALE	60Hz 208/230V(H)
A	49
(B.G.N IS ALREADY RECTIFIED)	
OPERATING CONDITIONS	
POWER SOURCE	208/230V 60Hz
JIS STANDARD	
○	60Hz 208/230V
○	Cooling

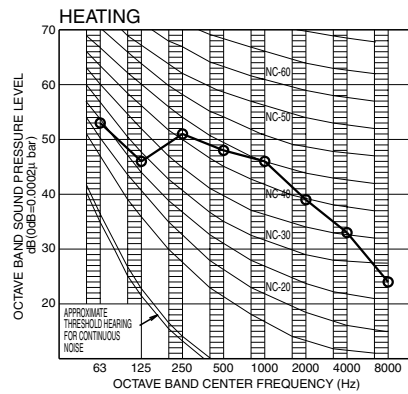

OVER ALL (dB)	
SCALE	60Hz 208/230V(H)
A	51
(B.G.N IS ALREADY RECTIFIED)	
OPERATING CONDITIONS	
POWER SOURCE	208/230V 60Hz
JIS STANDARD	
○	60Hz 208/230V
○	Heating

3D047645C

RX15/18FVJU

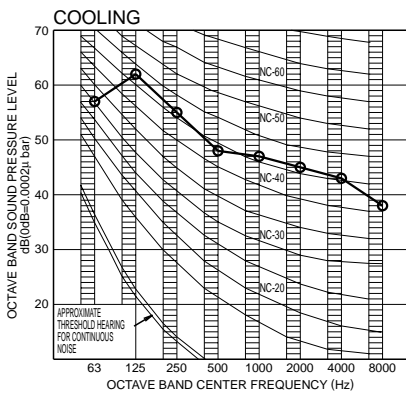

OVER ALL (dB)	
SCALE	60Hz 208/230V
A	51
(B.G.N IS ALREADY RECTIFIED)	
OPERATING CONDITIONS	
POWER SOURCE	208/230V 60Hz
JIS STANDARD	
○	60Hz 208/230V
○	Cooling

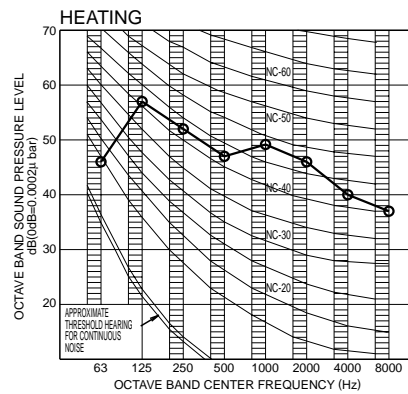

OVER ALL (dB)	
SCALE	60Hz 208/230V
A	51
(B.G.N IS ALREADY RECTIFIED)	
OPERATING CONDITIONS	
POWER SOURCE	208/230V 60Hz
JIS STANDARD	
○	60Hz 208/230V
○	Heating

3D047647A

RX24FVJU

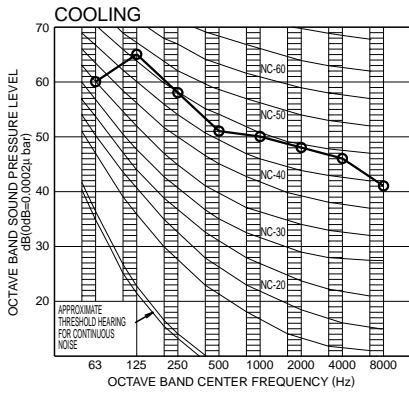

OVER ALL (dB)

SCALE	60Hz 208/230V
A	54

(B.G.N IS ALREADY RECTIFIED)

OPERATING CONDITIONS

POWER SOURCE 208/230V 60Hz

JIS STANDARD

○—○ 60Hz 208/230V

Cooling

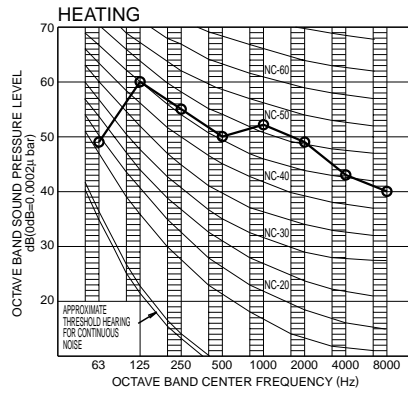

OVER ALL (dB)

SCALE	60Hz 208/230V
A	54

(B.G.N IS ALREADY RECTIFIED)

OPERATING CONDITIONS

POWER SOURCE 208/230V 60Hz

JIS STANDARD

○—○ 60Hz 208/230V

Heating

3D047648B

10. Electric Characteristics

Representative Unit Combination		Power Supply				COMP	OFM		IFM	
Indoor Unit	Outdoor Unit	Hz-Volts	Voltage Range	MCA	MFA	RLA	W	FLA	W	FLA
FTXS09HVJU	RX09FAVJU	60-208	MAX. 60Hz 253V MIN. 60Hz 187V	6.1	15	5.1	31	0.2	18	0.2
		60-230				4.6				0.18
FTXS12HVJU	RX12FAVJU	60-208	MAX. 60Hz 253V MIN. 60Hz 187V	7.9	15	6.7	31	0.2	18	0.2
		60-230				6.0				0.18
FTXS15HVJU	RX15FVJU	60-208	MAX. 60Hz 253V MIN. 60Hz 187V	13.7	20	11.8	53	0.24	43	0.2
		60-230				10.7				0.18
FTXS18HVJU	RX18FVJU	60-208	MAX. 60Hz 253V MIN. 60Hz 187V	14.1	20	12.2	53	0.24	43	0.2
		60-230				11.0				0.18
FTXS24HVJU	RX24FVJU	60-208	MAX. 60Hz 253V MIN. 60Hz 187V	15.8	20	13.6	53	0.26	43	0.22
		60-230				12.3				0.2

Symbols:

MCA : MIN. CIRCUIT AMPS (A)
 MFA : MAX. FUSE AMPS (A)
 RLA : RATED LOAD AMPS (A)
 OFM : OUTDOOR FAN MOTOR
 IFM : INDOOR FAN MOTOR
 FLA : FULL LOAD AMPS (A)
 W : FAN MOTOR RATED OUTPUT (W)
 RHz : RATED OPERATING FREQUENCY (Hz)

Note:

1. RLA is based on the following conditions.
Indoor temp. 80°FDB/67°FWB
Outdoor temp. 95°FDB/75°FWB
2. Maximum allowable voltage variation between phases is 2%.
3. Select wire size based on the larger value of MCA.
4. Instead of a fuse, use a circuit breaker.
5. Be sure to install a ground leak detector. (One that can handle higher harmonics.)
This unit uses an inverter, which means that it must be used with a ground leak detector capable handling high harmonics in order to prevent malfunctioning of the ground leak detector itself.

3D056378B

11. Installation Manual

11.1 Indoor Units

11.1.1 Safety Precautions

Safety Precautions

- Read these Safety Precautions carefully to ensure correct installation.
- This manual classifies the precautions into DANGER, WARNING and CAUTION. Be sure to follow all the precautions below: they are all important for ensuring safety.

	DANGER	Indicates an imminently hazardous situation which, if not avoided, will result in death or serious injury.
	WARNING	Failure to follow any of WARNING is likely to result in such grave consequences as death or serious injury.
	CAUTION	Failure to follow any of CAUTION may in some cases result in grave consequences.

- The following safety symbols are used throughout this manual:

	Be sure to observe this instruction.		Be sure to establish a ground connection.		Never attempt.
--	--------------------------------------	--	---	--	----------------

- After completing installation, test the unit to check for installation errors. Give the user adequate instructions concerning the use and cleaning of the unit according to the Operation Manual.

DANGER

- Refrigerant gas is heavier than air and replaces oxygen. A massive leak could lead to oxygen depletion, especially in basements, and an asphyxiation hazard could occur leading to serious injury or death.
- If the refrigerant gas leaks during installation, ventilate the area immediately.
Refrigerant gas may produce a toxic gas if it comes in contact with fire such as from a fan heater, stove or cooking device. Exposure to this gas could cause severe injury or death.
- After completing the installation work, check that the refrigerant gas does not leak.
Refrigerant gas may produce a toxic gas if it comes in contact with fire such as from a fan heater, stove or cooking device. Exposure to this gas could cause severe injury or death.
- Do not ground units to water pipes, telephone wires or lightning rods because incomplete grounding could cause a severe shock hazard resulting in severe injury or death, and to gas pipes because a gas leak could result in an explosion which could lead to severe injury or death.
- Safely dispose of the packing materials.
Packing materials, such as nails and other metal or wooden parts, may cause stabs or other injuries. Tear apart and throw away plastic packaging bags so that children will not play with them. Children playing with plastic bags face the danger of death by suffocation.
- Do not install unit in an area where flammable materials are present due to risk of explosion resulting in serious injury or death.
- Do not ground units to telephone wires or lightning rods because lightning strikes could cause a severe shock hazard resulting in severe injury or death, and to gas pipes because a gas leak could result in an explosion which could lead to severe injury or death.

WARNING

- Installation should be left to the authorized dealer or another trained professional.
Improper installation may cause water leakage, electrical shock, fire, or equipment damage.
- Install the air conditioner according to the instructions given in this manual.
Incomplete installation may cause water leakage, electrical shock, fire or equipment damage.
- Be sure to use the supplied or exact specified installation parts.
Use of other parts may cause the unit to come to lose, water leakage, electrical shock, fire or equipment damage.
- Install the air conditioner on a solid base that is level and can support the weight of the unit.
An inadequate base or incomplete installation may cause injury or equipment damage in the event the unit falls off the base or comes loose.
- Electrical work should be carried out in accordance with the installation manual and the national, state and local electrical wiring codes.
Insufficient capacity or incomplete electrical work may cause electrical shock, fire or equipment damage.
- Be sure to use a dedicated power circuit. Never use a power supply shared by another appliance.
Follow all appropriate electrical codes.
- For wiring, use a wire or cable long enough to cover the entire distance with no splices if possible. Do not use an extension cord. Do not put other loads on the power supply. Use a only a separate dedicated power circuit.
(Failure to do so may cause abnormal heat, electric shock, fire or equipment damage.)
- Use the specified types of wires for electrical connections between the indoor and outdoor units. Follow all state and local electrical codes.
Firmly clamp the interconnecting wires so their terminals receive no external stresses. Incomplete connections or clamping may cause terminal overheating, fire or equipment damage.
- After connecting all wiring be sure to shape the cables so that they do not put undue stress on the electrical covers, panels or terminals.
Install covers over the wires. Incomplete cover installation may cause terminal overheating, electrical shock, fire or equipment damage.

Safety Precautions

WARNING

- When installing or relocating the system, be sure to keep the refrigerant circuit free from all substances other than the specified refrigerant (R410A), such as air. (Any presence of air or other foreign substance in the refrigerant circuit causes an abnormal pressure rise which may result in rupture, resulting in injury.)
- During pump-down, stop the compressor before removing the refrigerant piping.
If the compressor is still running and the stop valve is open during pump-down, air will be sucked in when the refrigerant piping is removed, causing abnormally high pressure which could lead to equipment damage or and personal injury.
- During installation, attach the refrigerant piping securely before running the compressor.
If the compressor is not attached and the stop valve is open during pump-down, air will be sucked in when the compressor is run, causing abnormally high pressure which could lead to equipment damage and personal injury.
- Be sure to install a ground fault circuit interrupter breaker.
Failure to install a ground fault circuit interrupter breaker may result in electrically shocks, or fire personal injury.

CAUTION

- Do not install the air conditioner where gas leakage would be exposed to open flames.
If the gas leaks and builds up around the unit, it may catch fire.
- Establish drain piping according to the instructions of this manual.
Inadequate piping may cause water damage.
- Tighten the flare nut according to the specified torque. A torque wrench should be used.
If the flare nut is tightened too much, the flare nut may crack over time and cause refrigerant leakage.
- Do not touch the heat exchanger fins.
Improper handling may result in injury.
- Be very careful about product transportation.
Some products use PP bands for packaging. Do not use any PP bands for a means of transportation. It is dangerous.

11.1.2 09/12 Class

Accessories

(A) Mounting plate	1	(E) Remote controller holder	1	(K) Operation manual	1
(B) Mounting plate fixing screws 3/16" × 1"L (M4 × 25mm)	10	(F) Fixing screws for remote controller holder 1/8" × 13/16"L (M3 × 20mm)	2	(L) Installation manual	1
(C) Air-purifying filter with photocatalytic deodorizing function	2	(G) Dry batteries AAA. LR03 (alkaline)	2		
(D) Wireless remote controller	1	(H) Indoor unit fixing screws 3/16" × 1/2"L (M4 × 12mm)	2		

Choosing a Site

- Before choosing the installation site, obtain user approval.
- 1. Indoor unit.**
 - The indoor unit should be sited in a place where:
 - 1) the restrictions on installation specified in the indoor unit installation drawings are met,
 - 2) both air intake and exhaust have clear paths met,
 - 3) the unit is not in the path of direct sunlight,
 - 4) the unit is away from the source of heat or steam,
 - 5) there is no source of machine oil vapor as it may shorten the life of the indoor unit,
 - 6) cool air is circulated throughout the room,
 - 7) the unit is away from electronic ignition type fluorescent lamps (inverter or rapid start type) as they may shorten the remote controller range,
 - 8) the unit is at least 3.5 ft (1m) away from any television or radio set (unit may cause interference with the picture or sound).
 - 2. Wireless remote controller.**
 - 1) Turn on all the fluorescent lamps in the room, if any, and find the site where remote controller signals are properly received by the indoor unit (within 23 ft (7m)).

Indoor Unit Installation Drawings

ⓑ 3/16" × 1"L (M4 × 25mm)

Ⓐ Mounting plate

The mounting plate should be installed on a wall which can support the weight of the indoor unit.

■ **How to attach the indoor unit.**
Hook the claws of the bottom frame to the mounting plate. If the claws are difficult to hook, remove the front grille.

■ **How to remove the indoor unit.**
Push up the marked area (at the lower part of the front grille) to release the claws. If it is difficult to release, remove the front grille.

1-3/16" (30mm) or more from ceiling

1-15/16" (50mm) or more from walls (on both sides)

Front panel

Caulk pipe hole gap with putty.

Cut thermal insulation pipe to an appropriate length and wrap it with tape, making sure that no gap is left in the insulation pipe's cut line.

Wrap the insulation pipe with the finishing tape from bottom to top.

Air filters

Ⓒ Air-purifying filter with photocatalytic deodorizing function

Install Air-purifying filter with photocatalytic deodorizing function on air filter

Ⓒ Air-purifying filter with photocatalytic deodorizing function

Air filter

Ⓒ Air-purifying filter with photocatalytic deodorizing function

Service lid

■ **Opening service lid**
Service lid is opening/closing type.
Opening method

- 1) Remove the screws on the service lid.
- 2) Slide the service lid leftward.
- 3) Rotate the service lid upward.

Ⓓ Wireless remote controller

Before screwing the remote controller holder to the wall, make sure that control signals are properly received by indoor unit.

Ⓔ Remote controller holder

Ⓕ 1/8" × 13/16"L (M3 × 20mm)

Intelligent-eye Sensor

Adjusting the angle

- 1) Once installation of the indoor unit is complete, adjust the angle of the Intelligent-eye sensor to ensure the detection area properly covers the room. (Adjustable angle: 15° to right and left of center)
- 2) Gently push and slide the sensor to adjust the angle. Aim so that the sensor is pointing to the center of the room, or to the part of the room that is most frequently used.
- 3) After adjusting the angle, gently wipe the sensor with a clean cloth, being careful not to scratch the sensor.

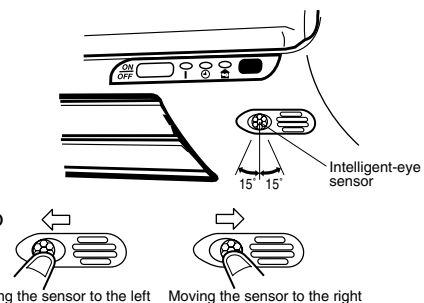

⚠ CAUTION

- 1) Do not hit or violently push the intelligent-eye sensor. This can lead to damage and malfunction.
- 2) Do not place large objects near the sensor. Also keep heating units or humidifiers outside the sensor's detection area.

Installation Tips

1. Removing and installing front panel.

• Removal method

Hook fingers on the panel protrusions on the left and right of the main body, and open until the panel stops. Slide the front panel sideways to disengage the rotating shaft. Then pull the front panel toward you to remove it.



• Installation method

Align the tabs of the front panel with the grooves, and push all the way in. Then close slowly. Push the center of the lower surface of the panel firmly to engage the tabs.

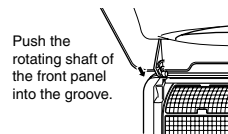

If it is difficult to remove, open the front grille and raise the top grid, using a screwdriver, to unhook the hooks.

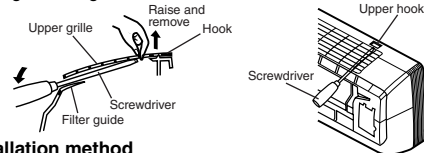

• Installation method

- 1) Attach the front grille to the bottom frame, and lock the upper hooks (2 points) securely.
- 2) Install 2 screws of the front grill.
- 3) Install the air filter and then mount the front panel.

3. How to set the different addresses.

When two indoor units are installed in one room, the two wireless remote controllers can be set for different addresses.

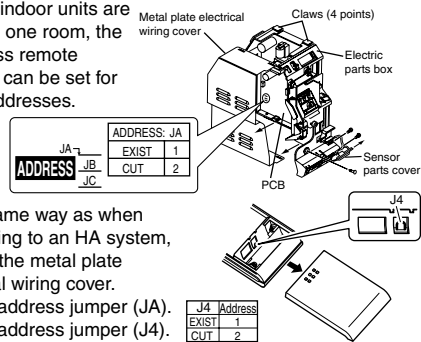

- 1) In the same way as when connecting to an HA system, remove the metal plate electrical wiring cover.
- 2) Cut the address jumper (JA).
- 3) Cut the address jumper (J4).

2. Removing and installing front grille.

• Removal method

- 1) Remove front panel to remove the air filter.
- 2) Remove the front grille. (2 screws)
- 3) Pull the lower part of the front grille toward you, then remove the front grille completely.
(There are 2 hooks on the upper part.)

Indoor Unit Installation (1)

1. Installing the mounting plate.

- The mounting plate should be installed on a wall which can support the weight of the indoor unit.
- 1) Temporarily secure the mounting plate to the wall, make sure that the panel is completely level, and mark the boring points on the wall.
- 2) Secure the mounting plate to the wall with screws.

Recommended mounting-plate retention spots and Dimensions

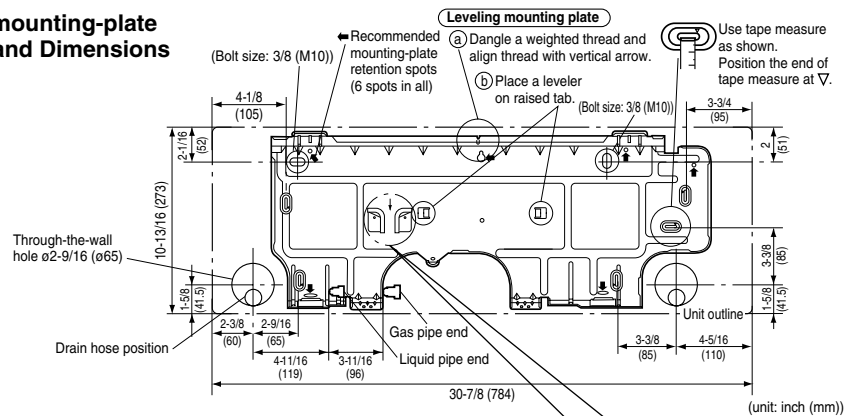

* The removed pipe port cover can be kept in the mounting plate pocket.



Removed pipe port cover

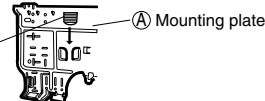

Indoor Unit Installation (2)

2. Boring a wall hole and installing wall embedded pipe.

- For walls containing metal frame or metal board, be sure to use a wall embedded pipe and wall cover in the feed-through hole to prevent possible heat, electrical shock, or fire.
 - Be sure to caulk the gaps around the pipes with caulking material to prevent water leakage.
- 1) Bore a feed-through hole of 2-9/16 inch (65mm) in the wall so it has a down slope toward the outside.
 - 2) Insert a wall pipe into the hole.
 - 3) Insert a wall cover into wall pipe.
 - 4) After completing refrigerant piping, wiring, and drain piping, caulk pipe hole gap with putty.

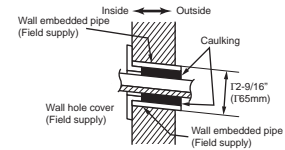

3. Installing indoor unit.

3-1. Right-side, right-back, or right-bottom piping.

- 1) Attach the drain hose to the underside of the refrigerant pipes with adhesive vinyl tape.
- 2) Wrap the refrigerant pipes and drain hose together with insulation tape.
- 3) Pass the drain hose and refrigerant pipes through the wall hole, then set the indoor unit on the mounting plate hooks by using the Δ markings at the top of the indoor unit as a guide.
- 4) Open the front panel, then open the service lid. (Refer to Installation Tips.)
- 5) Pass the interconnecting wires from the outdoor unit through the feed-through wall hole and then through the back of the indoor unit. Pull them through the front side. Bend the ends of tie wires upward in advance for easier work. (If the interconnecting wire ends are to be stripped first, bundle wire ends with adhesive tape.)
- 6) Press the indoor unit's bottom panel with both hands to set it on the mounting plate hooks. Make sure the wires do not catch on the edge of the indoor unit.

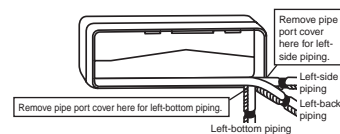
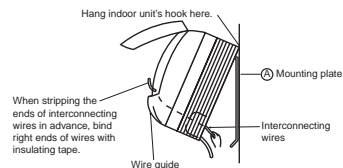
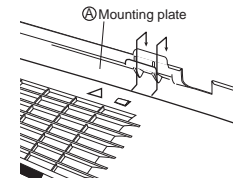
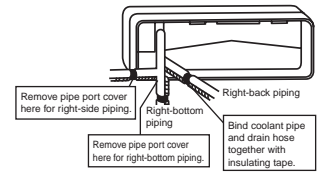

3-2. Left-side, left-back, or left-bottom piping.

- 1) Attach the drain hose to the underside of the refrigerant pipes with adhesive vinyl tape.
- 2) Be sure to connect the drain hose to the drain port in place of a drain plug.
- 3) Shape the refrigerant pipe along the pipe path marking on the mounting plate.
- 4) Pass drain hose and refrigerant pipes through the wall hole, then set the indoor unit on mounting plate hooks, using the Δ markings at the top of indoor unit as a guide.
- 5) Pull in the interconnecting wires.
- 6) Connect the inter-unit piping.
- 7) Wrap the refrigerant pipes and drain hose together with insulation tape as right figure, in case of setting the drain hose through the back of the indoor unit.
- 8) While exercising care so that the interconnecting wires do not catch indoor unit, press the bottom edge of indoor unit with both hands until it is firmly caught by the mounting plate hooks. Secure indoor unit to the mounting plate with the screws (3/16" x 1/2" (M4 x 12mm)).

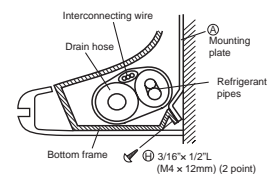
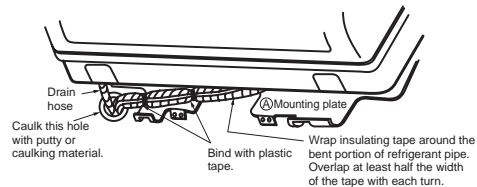
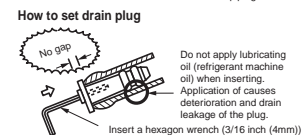

Indoor Unit Installation (3)

3-3. Wall embedded piping.

Follow the instructions given under

Left-side, left-back, or left-bottom piping

- 1) Insert the drain hose to this depth so it won't be pulled out of the drain pipe.

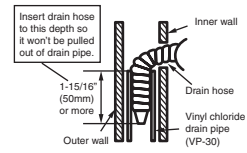

4. Wiring.

- 1) Strip wire ends. (9/16 inch (15mm))
- 2) Match wire colors with terminal numbers on indoor and outdoor unit's terminal blocks and firmly screw wires to the corresponding terminals.
- 3) Connect the ground wires to the corresponding terminals.
- 4) Pull wires to make sure that they are securely latched up.
- 5) In case of connecting to an adapter system. Run the remote controller cable and attach the S21 connector as the illustration above.
- 6) Shape the wires so that the service lid fits securely, then close service lid.

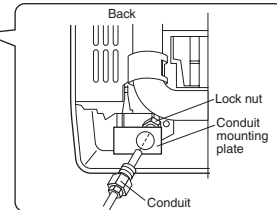
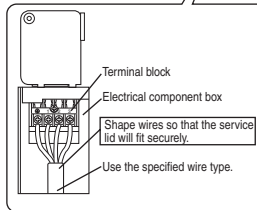

When wire length exceeds 33ft (10m), use AWG14 wires.

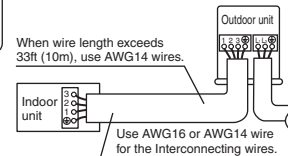

WARNING

- 1) Do not use spliced wires, strand wires, extension cords, or starburst connections, as they may cause overheating, electrical shock, or fire. Follow all Local, and State/Provincial electrical codes.
- 2) Do not use locally purchased electrical parts inside the product. (Do not overload the circuit by adding drain pump or other electrical equipment to unit terminals.) Doing so may cause electric shock or fire.
- 3) When carrying out wiring connection, take care not to pull at the conduit.

5. When connecting to an HA system.

- 1) Remove the front grille. (2 screws)
- 2) Remove the electrical wiring box. (3 screw)
- 3) Remove the metal plate electrical wiring cover. (4 tabs)
- 4) Remove the resin plastic electrical wiring cover. (2 tabs)
- 5) Attach the connection cord to the S21 connector and pull the harness out through the notched part in the figure.
- 6) Replace the electrical wiring cover as it was, and pull the harness around, as shown in the figure.

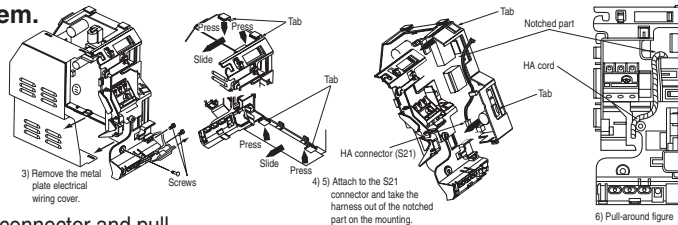

6. Drain piping.

- 1) Connect the drain hose, as described right.

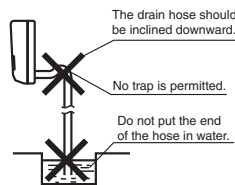

- 2) Remove the air filters and pour some water into the drain pan to check if the water flows smoothly.

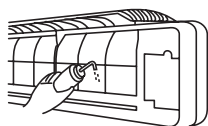

- 3) When drain hose requires extension, obtain an extension hose commercially available.

Be sure to thermally insulate the indoor section of the extension hose.

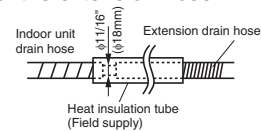

- 4) When connecting a rigid polyvinyl chloride pipe (nominal diameter 1/2 inch (13mm)) directly to the drain hose attached to the indoor unit as with embedded piping work, use any commercially available drain socket (nominal diameter 1/2 inch (13mm)) as a joint.

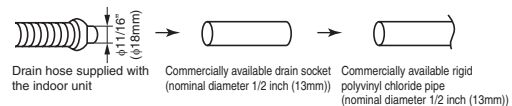

Refrigerant Piping Work

1. Flaring the pipe end.

- 1) Cut the pipe end with a pipe cutter.
- 2) Remove burrs with the cut surface facing downward so that the chips do not enter the pipe.
- 3) Put the flare nut on the pipe.
- 4) Flare the pipe.
- 5) Check that the flaring is properly made.

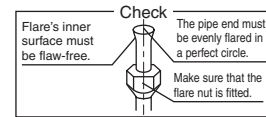
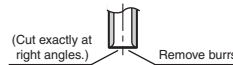

Set exactly at the position shown below.

Flare tool for R410A		Conventional flare tool	
Clutch-type	Clutch-type (Rigid-type)	Wing-nut type (Imperial-type)	
A	A	A	A
0 - 0.020 inch (0 - 0.5mm)	0.039 - 0.059 inch (1.0 - 1.5mm)	0.059 - 0.079 inch (1.5 - 2.0mm)	

⚠ WARNING

- 1) Do not use mineral oil on flared part.
- 2) Prevent mineral oil from getting into the system as this would reduce the unit life.
- 3) Never use piping which has been used for previous installations. Only use parts which are provided with the unit.
- 4) Never install a refrigerant drier to this unit.
- 5) The drying material may dissolve and damage the system.
- 6) Incomplete or improper flaring may cause refrigerant gas leakage.

2. Refrigerant piping.

⚠ CAUTION

- 1) Use the flare nut fixed to the main unit. (To prevent cracking of the flare nut by aged deterioration.)
- 2) To prevent gas leakage, apply refrigeration oil only to the inner surface of the flare. (Use refrigeration oil for R410A.)
- 3) Use torque wrenches when tightening the flare nuts to prevent damage to the flare nuts and gas leakage.

Align the centers of both flares and tighten the flare nuts 3 or 4 turns by hand. Then tighten them fully with the torque wrenches.

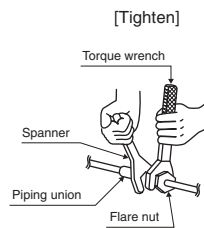
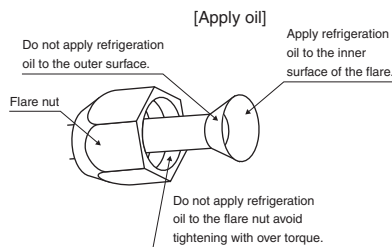

Flare nut tightening torque	
Gas side	Liquid side
3/8 inch	1/4 inch
24.1 - 29.4ft • lbf (32.7 - 39.9N • m)	10.4 - 12.7ft • lbf (14.2 - 17.2N • m)

2-1. Caution on piping handling

- 1) Protect the open end of the pipe against dust and moisture.
- 2) All pipe bends should be as gentle as possible. Use a pipe bender for bending.

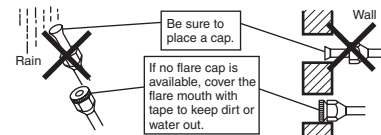

2-2. Selection of copper and heat insulation materials

- When using commercial copper pipes and fittings, observe the following:
 - 1) Insulation material: Polyethylene foam
Heat transfer rate: 0.041 to 0.052 W/mK (0.024 to 0.030 Btu/ft²°F (0.035 to 0.045 kcal/mh°C))
Choose heat insulation materials that are designed for HVAC use.

- 2) Be sure to insulate both the gas and liquid piping and to provide insulation dimensions as below.

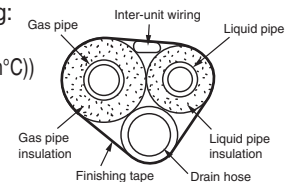

Gas side	Liquid side	Gas pipe thermal insulation	Liquid pipe thermal insulation
O.D. 3/8 inch (9.5mm)	O.D. 1/4 inch (6.4mm)	I.D. 0.427 - 0.590 inch (12 - 15mm)	I.D. 0.315 - 0.393 inch (8 - 10mm)
Minimum bend radius		Thickness 0.393 inch (8mm) Min.	
1-3/16 inch (30mm) or more			
Thickness 0.031 inch (0.8mm) (C1220T-O)			

- 3) Use separate thermal insulation pipes for gas and liquid refrigerant pipes.

Run Test and Final Check

1. Trial operation and testing.

- 1-1 Measure the supply voltage and make sure that it falls in the specified range.
- 1-2 Trial operation should be carried out in either cooling or heating mode.
- In cooling mode, select the lowest programmable temperature; in heating mode, select the highest programmable temperature.
 - 1) Trial operation may be disabled in either mode depending on the room temperature. Use the remote controller for trial operation as described below.
 - 2) After trial operation is complete, set the temperature to a normal level (78°F to 82°F (26°C to 28°C) in cooling mode, 68°F to 75°F (20°C to 24°C) in heating mode).
 - 3) For protection, the unit disables restart operation for 3 minutes after it is turned off.
- 1-3 Carry out the test operation in accordance with the Operation Manual to ensure that all functions and parts, are working properly.
- The air conditioner requires a small amount of power in its standby mode. If the system is not to be used for some time after installation, shut off the circuit breaker to eliminate unnecessary power consumption.
 - If the circuit breaker trips to shut off the power to the air conditioner, the system will restore the original operation mode when the circuit breaker is opened again.

Trial operation from remote controller.

- 1) Press the MODE button and select the trial operation mode.
- 2) Press ON/OFF button to turn on the system.
- 3) Simultaneously press MODE button and both of TEMP button.
- 4) Press MODE button twice.
("T" will appear on the display to indicate that Trial Operation mode is selected.)
- 5) Trial run mode terminates in approx. 30 minutes and switches into normal mode. To quit a trial operation, press ON/OFF button.

2. Test items.

Test items	Symptom	Check
Indoor and outdoor units are installed properly on solid bases.	Fall, vibration, noise	
No refrigerant gas leaks.	Incomplete cooling/heating function	
Refrigerant gas and liquid pipes and indoor drain hose extension are thermally insulated.	Water leakage	
Drain line is properly installed.	Water leakage	
System is properly grounded.	Electrical leakage	
The specified wires are used for interconnecting wire connections.	Inoperative or burn damage	
Indoor or outdoor unit's air intake or exhaust has clear path of air. Stop valves are opened.	Incomplete cooling/heating function	
Indoor unit properly receives remote controller commands.	Inoperative	

11.1.3 15/18/24 Class

Accessories					
Ⓐ Mounting plate	1	Ⓔ Remote controller holder	1	Ⓚ Operation manual	1
Ⓑ Mounting plate fixing screws 3/16" × 1"L (M4 × 25mm)	10	Ⓕ Fixing screws for remote controller holder 1/8" × 13/16"L (M3 × 20mm)	2	Ⓛ Installation manual	1
Ⓒ Air-purifying filter with photocatalytic deodorizing function	2	Ⓖ Dry batteries AAA. LR03 (alkaline)	2		
Ⓓ Wireless remote controller	1	Ⓗ Indoor unit fixing screws 3/16" × 1/2"L (M4 × 12mm)	2		

Choosing a Site

- Before choosing the installation site, obtain user approval.

- 1. Indoor unit.**
 - The indoor unit should be sited in a place where:
 - 1) the restrictions on installation specified in the indoor unit installation drawings are met,
 - 2) both air intake and exhaust have clear paths met,
 - 3) the unit is not in the path of direct sunlight,
 - 4) the unit is away from the source of heat or steam,
 - 5) there is no source of machine oil vapour (this may shorten indoor unit life),
 - 6) cool air is circulated throughout the room,
 - 7) the unit is away from electronic ignition type fluorescent lamps (inverter or rapid start type) as they may shorten the remote controller range,
 - 8) the unit is at least 3.5 ft (1m) away from any television or radio set (unit may cause interference with the picture or sound).
- 2. Wireless remote controller.**
 - 1) Turn on all the fluorescent lamps in the room, if any, and find the site where remote controller signals are properly received by the indoor unit (within 23 ft (7m)).

Indoor Unit Installation Drawings

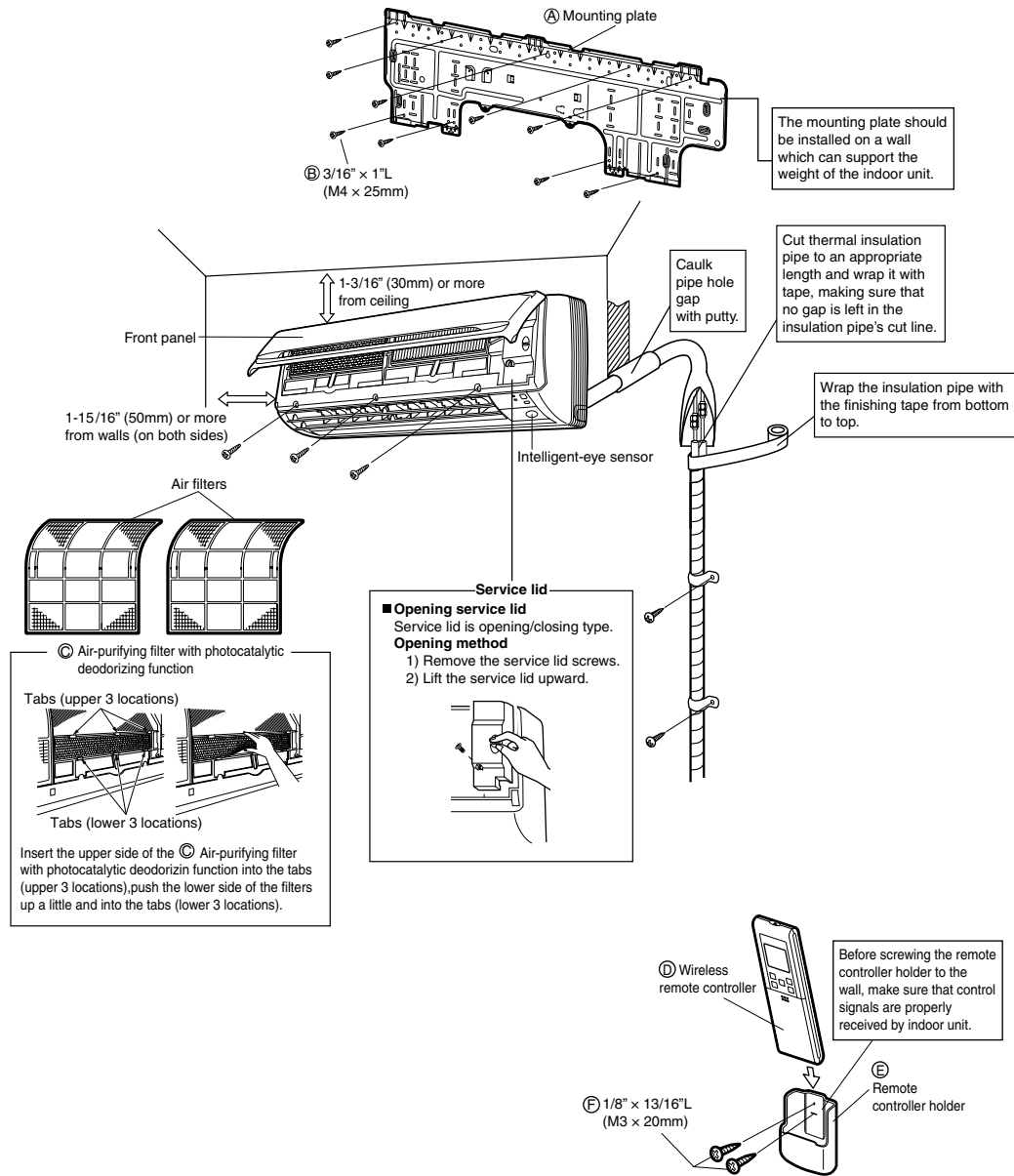

Intelligent-eye Sensor

⚠ CAUTION

- 1) Do not hit or violently push the intelligent-eye sensor. This can lead to damage and malfunction.
- 2) Do not place large objects near the sensor. Also keep heating units or humidifiers outside the sensor's detection area.

Installation Tips

1. Removing and installing front panel.

• Removal method

Hook fingers on the panel protrusions on the left and right of the main body, and open until the panel stops. Slide the front panel sideways to disengage the rotating shaft. Then pull the front panel toward you to remove it.

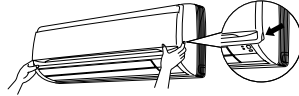

• Installation method

Align the tabs of the front panel with the grooves, and push all the way in. Then close slowly. Push the center of the lower surface of the panel firmly to engage the tabs.

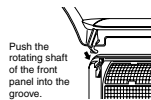

<When there is no work space because the unit is close to ceiling>

⚠ CAUTION

Be sure to wear protection gloves.

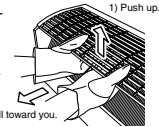

Place both hands under the center of the front grille, and while pushing up, pull it toward you.

• Installation method

- 1) Install the front grille and firmly engage the upper hooks. (3 locations)
- 2) Install 3 screws of the front grill.
- 3) Install the air filter and then mount the front panel.

3. How to set the different addresses.

When two indoor units are installed in one room, the two wireless remote controllers can be set for different addresses.

- 1) In the same way as when connecting to an HA system, remove the metal plate electrical wiring cover.
- 2) Cut the address jumper (JA).
- 3) Cut the address jumper (J4).

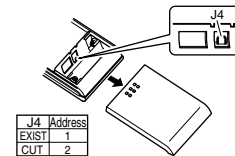
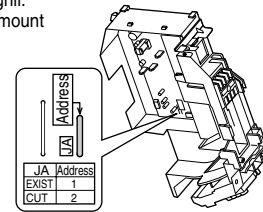

2. Removing and installing front grille.

• Removal method

- 1) Remove front panel to remove the air filter.
- 2) Remove the front grille. (3 screws)
- 3) In front of the ○○○ mark of the front grille, there are 3 upper hooks. Lightly pull the front grille toward you with one hand, and push down on the hooks with the fingers of your other hand.

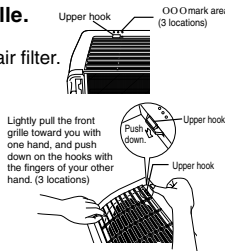

Indoor Unit Installation (1)

1. Installing the mounting plate.

- The mounting plate should be installed on a wall which can support the weight of the indoor unit.
- 1) Temporarily secure the mounting plate to the wall, make sure that the panel is completely level, and mark the boring points on the wall.
- 2) Secure the mounting plate to the wall with screws.

Recommended mounting-plate retention spots and Dimensions

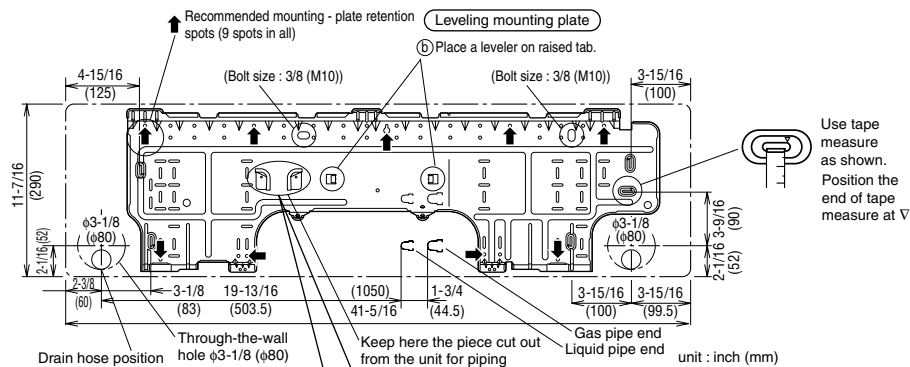

* The removed pipe port cover can be kept in the mounting plate pocket.

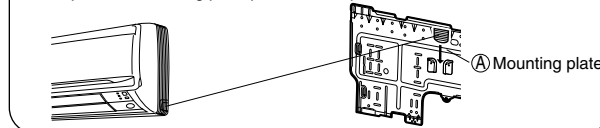

Indoor Unit Installation (2)

2. Boring a wall hole and installing wall embedded pipe.

- For walls containing metal frame or metal board, be sure to use a wall embedded pipe and wall cover in the feed-through hole to prevent possible heat, electrical shock, or fire.
 - Be sure to caulk the gaps around the pipes with caulking material to prevent water leakage.
- 1) Bore a feed-through hole of 3-1/8 inch (80mm) in the wall so it has a down slope toward the outside.
 - 2) Insert a wall pipe into the hole.
 - 3) Insert a wall cover into wall pipe.
 - 4) After completing refrigerant piping, wiring, and drain piping, caulk pipe hole gap with putty.

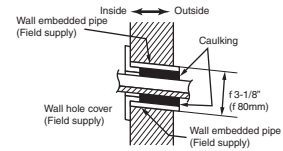

3. Installing indoor unit.

3-1. Right-side, right-back, or right-bottom piping.

- 1) Attach the drain hose to the underside of the refrigerant pipes with adhesive vinyl tape.
- 2) Wrap the refrigerant pipes and drain hose together with insulation tape.
- 3) Pass the drain hose and refrigerant pipes through the wall hole, then set the indoor unit on the mounting plate hooks by using the Δ markings at the top of the indoor unit as a guide.
- 4) Open the front panel, then open the service lid. (Refer to Installation Tips.)
- 5) Pass the interconnecting wires from the outdoor unit through the feed-through wall hole and then through the back of the indoor unit. Pull them through the front side. Bend the ends of tie wires upward in advance for easier work. (If the interconnecting wire ends are to be stripped first, bundle wire ends with adhesive tape.)
- 6) Press the indoor unit's bottom panel with both hands to set it on the mounting plate hooks. Make sure the wires do not catch on the edge of the indoor unit.

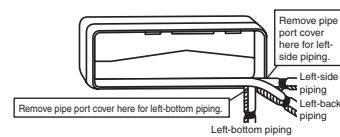
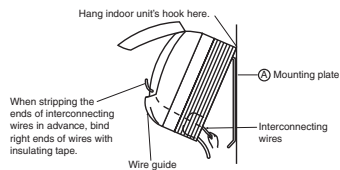
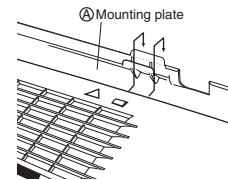
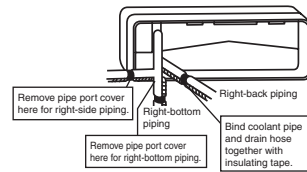

3-2. Left-side, left-back, or left-bottom piping.

- 1) Attach the drain hose to the underside of the refrigerant pipes with adhesive vinyl tape.
- 2) Be sure to connect the drain hose to the drain port in place of a drain plug.
- 3) Shape the refrigerant pipe along the pipe path marking on the mounting plate.
- 4) Pass drain hose and refrigerant pipes through the wall hole, then set the indoor unit on mounting plate hooks, using the Δ markings at the top of indoor unit as a guide.
- 5) Pull in the interconnecting wires.
- 6) Connect the inter-unit piping.
- 7) Wrap the refrigerant pipes and drain hose together with insulation tape as right figure, in case of setting the drain hose through the back of the indoor unit.
- 8) While exercising care so that the interconnecting wires do not catch indoor unit, press the bottom edge of indoor unit with both hands until it is firmly caught by the mounting plate hooks. Secure indoor unit to the mounting plate with the screws (3/16" x 1/2"L (M4 x 12mm)).

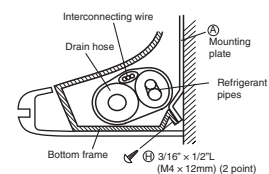
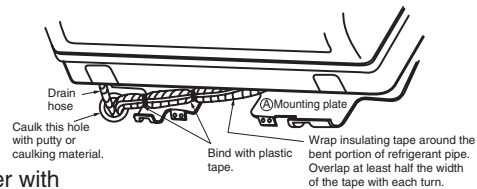
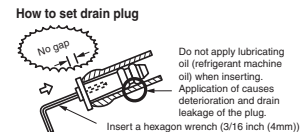

Indoor Unit Installation (3)

3-3. Wall embedded piping.

Follow the instructions given under

Left-side, left-back, or left-bottom piping

- 1) Insert the drain hose to this depth so it won't be pulled out of the drain pipe.

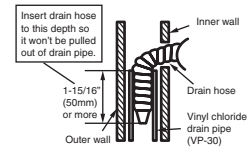

4. Wiring.

- 1) Strip wire ends. (9/16 inch (15mm))
- 2) Match wire colours with terminal numbers on indoor and outdoor unit's terminal blocks and firmly screw wires to the corresponding terminals.
- 3) Connect the ground wires to the corresponding terminals.
- 4) Pull wires to make sure that they are securely latched up.
- 5) In case of connecting to an adapter system. Run the remote controller cable and attach the S21 connector as the illustration above.
- 6) Shape the wires so that the service lid fits securely, then close service lid.

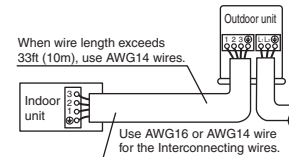
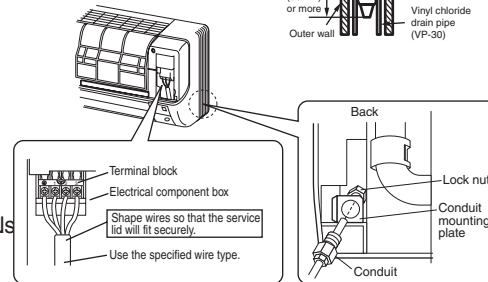

⚠ WARNING

- 1) Do not use spliced wires, strand wires, extension cords, or starburst connections, as they may cause overheating, electrical shock, or fire. Follow all Local, and State electrical codes.
- 2) Do not use locally purchased electrical parts inside the product. (Do not overload the circuit by adding drain pump or other electrical equipment to unit terminals.) Doing so may cause electric shock or fire.
- 3) When carrying out wiring connection, take care not to pull at the conduit.

5. When connecting to an HA system.

- 1) Remove the front grille. (3 screws)
- 2) Remove the electrical wiring box. (1 screw)
- 3) Remove the metal plate electrical wiring cover. (4 tabs)
- 4) Attach the connection cord to the S21 connector and pull the harness out through the notched part in the figure.
- 5) Replace the electrical wiring cover as it was, and pull the harness around, as shown in the figure.

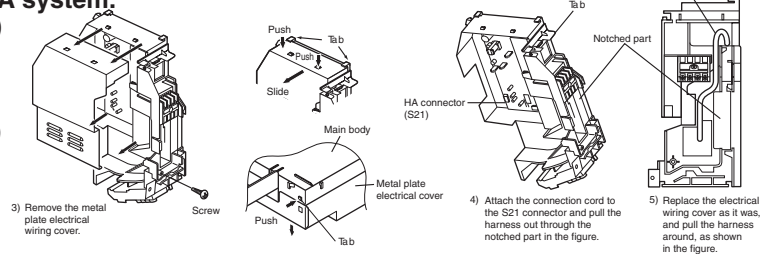

6. Drain piping.

- 1) Connect the drain hose, as described right.

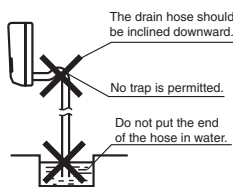

- 2) Remove the air filters and pour some water into the drain pan to check the water flows smoothly.

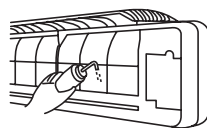

- 3) When drain hose requires extension, obtain an extension hose commercially available.

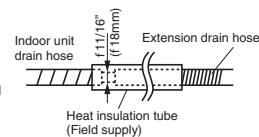

Be sure to thermally insulate the indoor section of the extension hose.

- 4) When connecting a rigid polyvinyl chloride pipe (nominal diameter 1/2 inch (13mm)) directly to the drain hose attached to the indoor unit as with embedded piping work, use any commercially available drain socket (nominal diameter 1/2 inch (13mm)) as a joint.

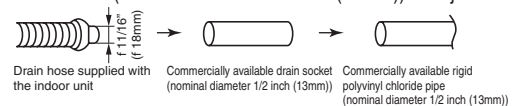

Refrigerant Piping Work

1. Flaring the pipe end.

- 1) Cut the pipe end with a pipe cutter.
- 2) Remove burrs with the cut surface facing downward so that the chips do not enter the pipe.
- 3) Put the flare nut on the pipe.
- 4) Flare the pipe.
- 5) Check that the flaring is properly made.

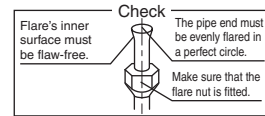
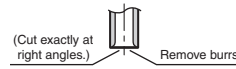

Flaring

Set exactly at the position shown below.

Die	Flare tool for R410A		Conventional flare tool	
	Clutch-type	Clutch-type (Rigid-type)	Wing-nut type (Imperial-type)	
A	0-0.020 inch (0-0.5mm)	0.039-0.059 inch (1.0-1.5mm)	0.059-0.079 inch (1.5-2.0mm)	

⚠ WARNING

- 1) Do not use mineral oil on flared part.
- 2) Prevent mineral oil from getting into the system as this would reduce the unit life.
- 3) Never use piping which has been used for previous installations. Only use parts which are provided with the unit.
- 4) Do never install a refrigerant drier to this unit.
- 5) The drying material may dissolve and damage the system.
- 6) Incomplete or improper flaring may cause refrigerant gas leakage.

2. Refrigerant piping.

⚠ CAUTION

- 1) Use the flare nut fixed to the main unit. (To prevent cracking of the flare nut by aged deterioration.)
- 2) To prevent gas leakage, apply refrigeration oil only to the inner surface of the flare. (Use refrigeration oil for R410A.)
- 3) Use torque wrenches when tightening the flare nuts to prevent damage to the flare nuts and gas leakage.

Align the centers of both flares and tighten the flare nuts 3 or 4 turns by hand. Then tighten them fully with the torque wrenches.

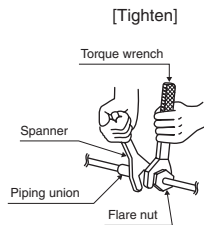
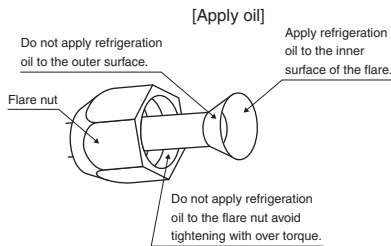

Flare nut tightening torque		
Gas side		Liquid side
1/2 inch	5/8 inch	1/4 inch
36.5-44.5ft • lbf (49.5-60.3N • m)	45.6-55.6ft • lbf (61.8-75.4N • m)	10.4-12.7ft • lbf (14.2-17.2N • m)

Choose heat insulation materials that are designed for HVAC use.

2-1. Caution on piping handling

- 1) Protect the open end of the pipe against dust and moisture.
- 2) All pipe bends should be as gentle as possible.
Use a pipe bender for bending.

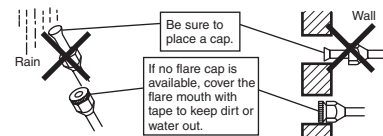

2-2. Selection of copper and heat insulation materials

- When using commercial copper pipes and fittings, observe the following:
 - 1) Insulation material: Polyethylene foam
Heat transfer rate: 0.041 to 0.052 W/mK (0.024 to 0.030 Btu/ft•h°F (0.035 to 0.045kcal/mh°C))
Choose heat insulation materials that are designed for HVAC use.

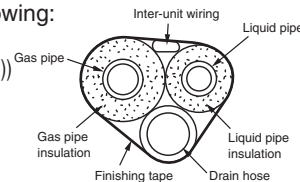

- 2) Be sure to insulate both the gas and liquid piping and to provide insulation dimensions as below.

Gas side		Liquid side	Gas pipe thermal insulation		Liquid pipe thermal insulation	
15/18 class	24 class	15/18/24 class	15/18 class	24 class	15/18/24 class	
O.D. 1/2 inch (12.7mm)	O.D. 5/8 inch (15.9mm)	O.D. 1/4 inch (6.4mm)	I.D. 0.551-0.630 inch (14-16mm)	I.D. 0.630-0.709 inch (16-20mm)	I.D. 0.315-0.393 inch (8-10mm)	
Minimum bend radius			Thickness 0.393 inch (8mm) Min.			
1-9/16 inch (40mm) or more	1-15/16 inch (50mm) or more	1-3/16 inch (30mm) or more				
Thickness 0.031 inch (0.8mm) (C1220T-O)	Thickness 0.039 inch (1.0mm) (C1220T-O)	Thickness 0.031 inch (0.8mm) (C1220T-O)				

- 3) Use separate thermal insulation pipes for gas and liquid refrigerant pipes.

Run Test and Final Check

1. Trial operation and testing.

- 1-1 Measure the supply voltage and make sure that it falls in the specified range.
- 1-2 Trial operation should be carried out in either cooling or heating mode.
 - In cooling mode, select the lowest programmable temperature; in heating mode, select the highest programmable temperature.
 - 1) Trial operation may be disabled in either mode depending on the room temperature. Use the remote controller for trial operation as described below.
 - 2) After trial operation is complete, set the temperature to a normal level (78°F to 82°F (26°C to 28°C) in cooling mode, 68°F to 75°F (20°C to 24°C) in heating mode).
 - 3) For protection, the unit disables restart operation for 3 minutes after it is turned off.
- 1-3 Carry out the test operation in accordance with the Operation Manual to ensure that all functions and parts, are working properly.
 - The air conditioner requires a small amount of power in its standby mode. If the system is not to be used for some time after installation, shut off the circuit breaker to eliminate unnecessary power consumption.
 - If the circuit breaker trips to shut off the power to the air conditioner, the system will restore the original operation mode when the circuit breaker is opened again.

Trial operation from remote controller.

- 1) Press the MODE button and select the trial operation mode.
- 2) Press ON/OFF button to turn on the system.
- 3) Simultaneously press MODE button and both of TEMP button.
- 4) Press MODE button twice.
(“T” will appear on the display to indicate that Trial Operation mode is selected.)
- 5) Trial run mode terminates in approx. 30 minutes and switches into normal mode. To quit a trial operation, press ON/OFF button.

2. Test items.



Test items	Symptom	Check
Indoor and outdoor units are installed properly on solid bases.	Fall, vibration, noise	
No refrigerant gas leaks.	Incomplete cooling/heating function	
Refrigerant gas and liquid pipes and indoor drain hose extension are thermally insulated.	Water leakage	
Drain line is properly installed.	Water leakage	
System is properly ground to earth.	Electrical leakage	
The specified wires are used for interconnecting wire connections.	Inoperative or burn damage	
Indoor or outdoor unit's air intake or exhaust has clear path of air. Stop valves are opened.	Incomplete cooling/heating function	
Indoor unit properly receives remote controller commands.	Inoperative	

11.2 Outdoor Units



11.2.1 Safety Precautions

Safety Precautions

- Read these Safety Precautions carefully to ensure correct installation.
- This manual classifies the precautions into DANGER, WARNING and CAUTION. Be sure to follow all the precautions below: they are all important for ensuring safety.

	DANGER	Indicates an imminently hazardous situation which, if not avoided, will result in death or serious injury.
	WARNING	Failure to follow any of WARNING is likely to result in such grave consequences as death or serious injury.
	CAUTION	Failure to follow any of CAUTION may in some cases result in grave consequences.

- The following safety symbols are used throughout this manual:

	Be sure to observe this instruction.		Be sure to establish a ground connection.		Never attempt.
---	--------------------------------------	---	---	---	----------------

- After completing installation, test the unit to check for installation errors. Give the user adequate instructions concerning the use and cleaning of the unit according to the Operation Manual.

DANGER

- Refrigerant gas is heavier than air and replaces oxygen. A massive leak could lead to oxygen depletion, especially in basements, and an asphyxiation hazard could occur leading to serious injury or death.
- If the refrigerant gas leaks during installation, ventilate the area immediately.
Refrigerant gas may produce a toxic gas if it comes in contact with fire such as from a fan heater, stove or cooking device. Exposure to this gas could cause severe injury or death.
- After completing the installation work, check that the refrigerant gas does not leak.
Refrigerant gas may produce a toxic gas if it comes in contact with fire such as from a fan heater, stove or cooking device. Exposure to this gas could cause severe injury or death.
- Do not ground units to water pipes, telephone wires or lightning rods because incomplete grounding could cause a severe shock hazard resulting in severe injury or death, and to gas pipes because a gas leak could result in an explosion which could lead to severe injury or death.
- Safely dispose of the packing materials. Packing materials, such as nails and other metal or wooden parts, may cause stabs or other injuries. Tear apart and throw away plastic packaging bags so that children will not play with them. Children playing with plastic bags face the danger of death by suffocation.
- Do not install unit in an area where flammable materials are present due to risk of explosion resulting in serious injury or death.
- Do not ground units to telephone wires or lightning rods because lightning strikes could cause a severe shock hazard resulting in severe injury or death, and to gas pipes because a gas leak could result in an explosion which could lead to severe injury or death.

WARNING

- Installation should be left to the authorized dealer or another trained professional.
Improper installation may cause water leakage, electrical shock, fire, or equipment damage.
- Install the air conditioner according to the instructions given in this manual.
Incomplete installation may cause water leakage, electrical shock, fire or equipment damage.
- Be sure to use the supplied or exact specified installation parts.
Use of other parts may cause the unit to come to lose, water leakage, electrical shock, fire or equipment damage.
- Install the air conditioner on a solid base that is level and can support the weight of the unit.
An inadequate base or incomplete installation may cause injury or equipment damage in the event the unit falls off the base or comes loose.
- Electrical work should be carried out in accordance with the installation manual and the national, state and local electrical wiring codes. Insufficient capacity or incomplete electrical work may cause electrical shock, fire or equipment damage.
- Be sure to use a dedicated power circuit. Never use a power supply shared by another appliance. Follow all appropriate electrical codes.
- For wiring, use a wire or cable long enough to cover the entire distance with no splices if possible. Do not use an extension cord. Do not put other loads on the power supply. Use a only a separate dedicated power circuit. (Failure to do so may cause abnormal heat, electric shock, fire or equipment damage.)
- Use the specified types of wires for electrical connections between the indoor and outdoor units. Follow all state and local electrical codes. Firmly clamp the interconnecting wires so their terminals receive no external stresses. Incomplete connections or clamping may cause terminal overheating, fire or equipment damage.
- After connecting all wiring be sure to shape the cables so that they do not put undue stress on the electrical covers, panels or terminals. Install covers over the wires. Incomplete cover installation may cause terminal overheating, electrical shock, fire or equipment damage.
- When installing or relocating the system, be sure to keep the refrigerant circuit free from all substances other than the specified refrigerant (R410A), such as air. (Any presence of air or other foreign substance in the refrigerant circuit causes an abnormal pressure rise which may result in rupture, resulting in injury.)

Safety Precautions

WARNING

- During pump-down, stop the compressor before removing the refrigerant piping.
If the compressor is still running and the stop valve is open during pump-down, air will be sucked in when the refrigerant piping is removed, causing abnormally high pressure which could lead to equipment damage or and personal injury.
- During installation, attach the refrigerant piping securely before running the compressor.
If the compressor is not attached and the stop valve is open during pump-down, air will be sucked in when the compressor is run, causing abnormally high pressure which could lead to equipment damage and personal injury.
- Install a leak circuit breaker, as required. If a leak circuit breaker is not installed, electric shock may result.
- Be sure to install a ground fault circuit interrupter breaker. Failure to install a ground fault circuit interrupter breaker may result in electrical shocks, fire, or personal injury.

CAUTION

- Do not install the air conditioner where gas leakage would be exposed to open flames.
If the gas leaks and builds up around the unit, it may catch fire.
- Establish drain piping according to the instructions of this manual. Inadequate piping may cause water damage.
- Tighten the flare nut according to the specified torque. A torque wrench should be used.
If the flare nut is tightened too much, the flare nut may crack over time and cause refrigerant leakage.
- Do not touch the heat exchanger fins.
Improper handling may result in injury.
- Be very careful about product transportation. Some products use PP bands for packaging. Do not use any PP bands for a means of transportation. It is dangerous.
- Make sure to provide for adequate measures in order to prevent that the outdoor unit be used as a shelter by small animals.
Small animals making contact with electrical parts can cause malfunctions, smoke or fire. Please instruct the customer to keep the area around the unit clean.

11.2.2 09/12 Class

Accessories

Accessories supplied with the outdoor unit:

(A) Installation manual	1	(B) Drain plug 	1	Located on the bottom of the packing case.
-------------------------	---	--------------------	---	--

Precautions for Selecting the Location

- 1) Choose a place strong enough to bear the weight and vibration of the unit. The location should not amplify operating sounds.
- 2) Choose a location where the hot air discharged from the unit and the operation sounds do not bother neighbors.
- 3) Avoid noise sensitive locations such as bedrooms to avoid future problems.
- 4) There must be sufficient clearance for carrying the unit into and out of the site.
- 5) There must be sufficient space around the air inlet and the air outlet with no obstructions to airflow.
- 6) The surrounding area must be free from the possibility of flammable gas leakage.
- 7) Install units, power cords and inter-connecting cables at least 10 feet away from television and radio sets. This is to prevent interference to images and sounds. (Noises may be heard even if they are more than 10 feet away depending on radio wave conditions.)
- 8) In coastal areas or other places with salty atmosphere of sulfate gas, corrosion may shorten the life of the air conditioner.
- 9) Do not place moisture sensitive equipment or articles under the outdoor unit condensate drain.

NOTE

Do not install unit by hanging from a ceiling or stacking units.

CAUTION

When operating the air conditioner in a outdoor temperature below, follow the instructions described below.

- 1) To prevent exposure to wind, install the outdoor unit with its suction side facing the wall.
- 2) Never install the outdoor unit at a site where the suction side may be exposed directly to wind.
- 3) To prevent exposure to wind, it is recommended to install a baffle plate on the air discharge side of the outdoor unit.
- 4) In heavy snowfall areas, select an installation site where the snow will not affect the unit.

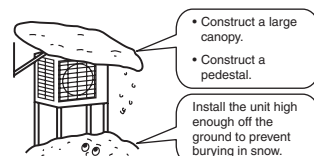

Precautions on Installation

- Ensure the strength and level of the installation will not cause any operating vibration or noise after installed.
- In accordance with the foundation drawing, fix the unit securely by means of the foundation bolts. (Prepare four sets of 3/8" or 7/16" foundation bolts, nuts and washers each which are available on the market.)
- It is best to screw in the foundation bolts until their length are 3/4" from the foundation surface.

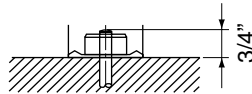

Outdoor Unit Installation Drawings

Model	09 / 12 class
Max. allowable length	65 ft
Max. allowable height	49 ft
Additional refrigerant required for refrigerant pipe exceeding 33 ft in length.	0.22 oz/ft
Gas pipe	O.D. 3/8"
Liquid pipe	O.D. 1/4"

* Be sure to add the proper amount of additional refrigerant. Failure to do so may result in reduced performance.

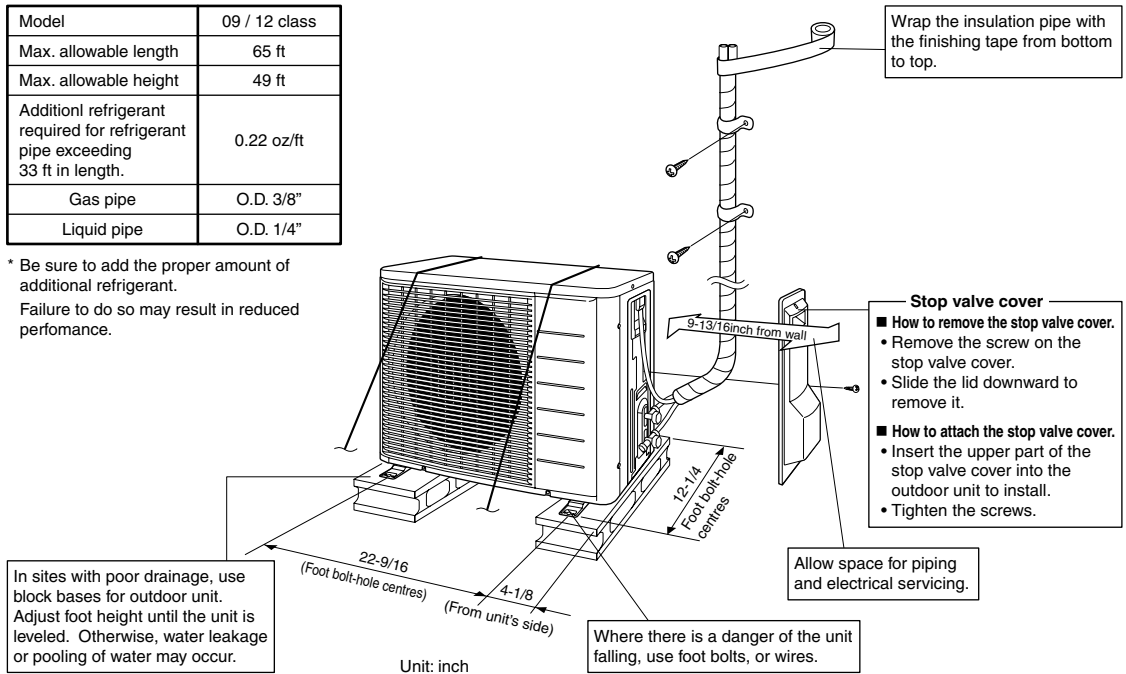

Installation Guidelines

- Where a wall or other obstacle is in the path of outdoor unit's intake or exhaust airflow, follow the installation guidelines below.
- For any of the below installation patterns, the wall height on the exhaust side should be 4 ft or less.

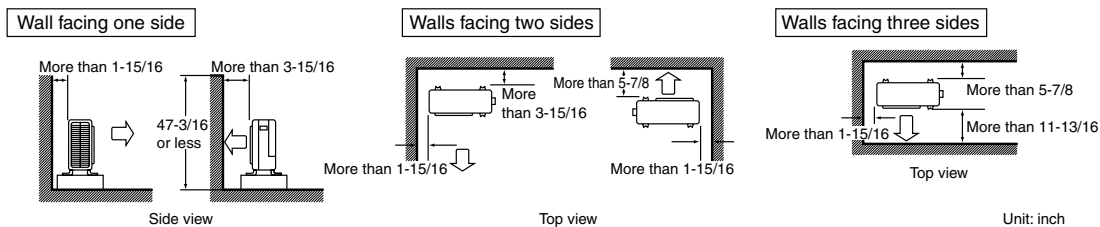

Outdoor Unit Installation (1)

1. Installing Outdoor Unit

- 1) When installing the outdoor unit, refer to "Precautions for Selecting the Location" and the "Outdoor Unit Installation Drawings."
- 2) If drain work is necessary, follow the procedures below.

2. Drain Work

- 1) Use drain plug for drainage.
- 2) If the drain port is covered by a mounting base or floor surface, place additional foot bases of at least 1-1/4" inch height under the outdoor unit's feet.
- 3) In cold areas, do not use a drain hose with the outdoor unit. (Otherwise, drain water may freeze, impairing heating performance.)

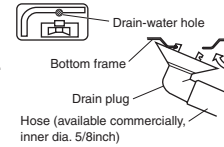

3. Flaring the Pipe End

- 1) Cut the pipe end with a pipe cutter.
- 2) Remove burrs with the cut surface facing downward so that the chips do not enter the pipe.
- 3) Put the flare nut on the pipe.
- 4) Flare the pipe.
- 5) Check that the flaring is properly made.



Flaring

Set exactly at the position shown below.

Die	Flare tool for R410A		Conventional flare tool	
	Clutch-type	Clutch-type (Rigid-type)	Wing-nut type (Imperial-type)	
A	0-0.020"	0.039-0.059"	0.059-0.079"	

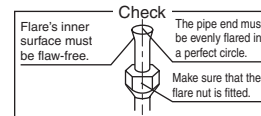

⚠ WARNING

- 1) Do not use mineral oil on flared part.
- 2) Prevent mineral oil from getting into the system as this would reduce the unit life.
- 3) Never use piping which has been used for previous installations. Only use parts which are provided with the unit.
- 4) Never install a refrigerant drier to this unit.
- 5) The drying material may dissolve and damage the system.
- 6) Incomplete or improper flaring may cause refrigerant gas leakage.

4. Refrigerant Piping

⚠ CAUTION

- 1) Use the flare nut fixed to the main unit to prevent cracking and deterioration.
- 2) To prevent gas leakage, apply refrigeration oil only to the inner surface of the flare. (Use refrigeration oil for R410A.)
- 3) Use torque wrenches when tightening the flare nuts to prevent damage to the flare nuts and gas leakage.

Align the centers of both flares and tighten the flare nuts 3 or 4 turns by hand. Then tighten them fully with the torque wrenches.

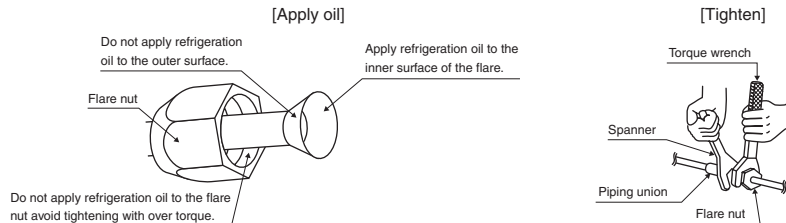

Flare nut tightening torque		Valve cap tightening torque	
Gas side	Liquid side	Gas side	Liquid side
3/8 inch	1/4 inch	3/8 inch	1/4 inch
24.1-29.4ft • lbf	10.4-12.7ft • lbf	15.9-20.2ft • lbf	15.9-20.2ft • lbf
		Service port cap tightening torque	7.9-10.8ft • lbf

Outdoor Unit Installation (2)

5. Purging Air and Checking for Gas Leakage

- When the piping work is completed, it is necessary to purge the air and check for gas leakage.

⚠ WARNING

- Do not place any substance other than the specified refrigerant (R410A) into the refrigeration cycle.
- When a refrigerant gas leak occurs, ventilate the room as soon and as much as possible.
- R410A, as well as other refrigerants, should always be recovered and never be released directly into the environment.
- Use a vacuum pump for R410A exclusively. Using the same vacuum pump for different refrigerants may damage the vacuum pump or the unit.

- If adding additional refrigerant, perform air purging from the refrigerant pipes and indoor unit using a vacuum pump before charging additional refrigerant.
- Use a hexagonal wrench (3/16") to operate the stop valve rod.
- All refrigerant pipe joints should be tightened with a torque wrench to the specified tightening torque.

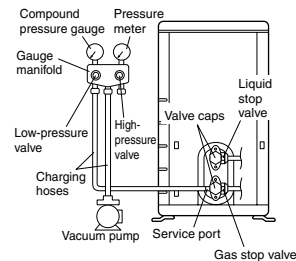

- Connect projection side of charging hose (which comes from gauge manifold) to gas stop valve's service port.
- Fully open gauge manifold's low-pressure valve (Lo) and completely close its high-pressure valve (Hi). (High-pressure valve subsequently requires no operation.)
- Do vacuum pumping and make sure that the vacuum pressure gauge reads - 29.9 inHg *1.
- Close gauge manifold's low-pressure valve (Lo) and stop vacuum pump. (Keep this state for a few minutes to make sure that the vacuum pressure gauge pointer does not swing back.)*2.
- Remove valve caps from liquid stop valve and gas stop valve.
- Turn the liquid stop valve's rod 90 degrees counterclockwise with a hexagonal wrench to open valve. Close it after 5 seconds, and check for gas leakage. Using soapy water, check for gas leakage from indoor unit's flare and outdoor unit's flare and valve rods. After the check is complete, wipe all soapy water off.
- Disconnect charging hose from gas stop valve's service port, then fully open liquid and gas stop valves. (Do not attempt to turn valve rod beyond its stop.)
- Tighten valve caps and service port caps for the liquid and gas stop valves with a torque wrench at the specified torques.

*1. Pipe length vs. vacuum pump run time

Pipe length	Up to 50 feet	More than 50 feet
Run time	Not less than 10 min.	Not less than 15 min.

*2. If the vacuum pressure gauge pointer swings back, refrigerant may have water content or a loose pipe joint may exist. Check all pipe joints and retighten nuts as needed, then repeat steps 2) through 4).

Outdoor Unit Installation (3)

6. Refilling The Refrigerant

Check the type of refrigerant to be used on the machine nameplate.

Precautions when adding R410A

Fill from the liquid pipe in liquid form.

It is a mixture of refrigerant, so adding it in gas form may cause the refrigerant composition to change, preventing normal operation.

- 1) Before filling, check whether the cylinder has a siphon attached or not. (It should have something like “liquid filling siphon attached” displayed on it.)
 - Be sure to use the R410A tools to ensure pressure and to prevent foreign objects entering.

Filling a cylinder with an attached siphon

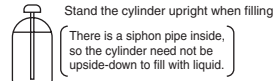

Filling other cylinders

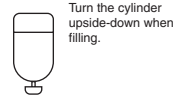

7. Refrigerant Piping Work

7-1 Cautions on Pipe Handling

- 1) Protect the open end of the pipe against dust and moisture.
- 2) All pipe bends should be as gentle as possible. Use a pipe bender for bending.

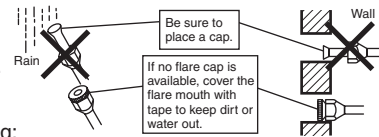

7-2 Selection of Copper and Heat Insulation materials

When using commercial copper pipes and fittings, observe the following:

- 1) Insulation material: Polyethylene foam
Heat transfer rate: 0.041 to 0.052 W/mK (0.024-0.030 Btu/ft²°F)
Choose heat insulation materials that are designed for HVAC use.

- 2) Be sure to insulate both the gas and liquid piping and to provide insulation dimensions as below.

Gas side	Liquid side	Gas pipe thermal insulation	Liquid pipe thermal insulation
09/12 class		09/12 class	
O.D. 3/8 inch	O.D. 1/4 inch	I.D. 0.472-0.590 inch	I.D. 0.315-0.393 inch
Minimum bend radius		Thickness 0.393 inch Min.	
1-3/16 inch or more			
Thickness 0.031 inch (C1220T-O)			

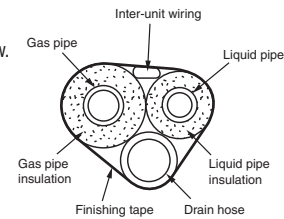

- 3) Use separate thermal insulation pipes for gas and liquid refrigerant pipes.

Pump Down Operation

In order to protect the environment, be sure to pump down when relocating or disposing of the unit.

- 1) Remove the valve cap from liquid stop valve and gas stop valve.
- 2) Carry out forced cooling operation.
- 3) After 5 to 10 minutes, close the liquid stop valve with a hexagonal wrench.
- 4) After 2 to 3 minutes, close the gas stop valve and stop forced cooling operation.

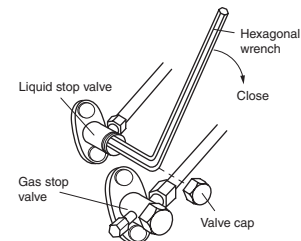

How to force cooling operation mode

■ Using the indoor unit operation/stop button

Press the indoor unit operation/stop button for at least 5 seconds. (Operation will start.)

- Forced cooling operation will stop automatically after around 15 minutes.
To force a test run to stop, press the indoor unit operation/stop button.

■ Using the main unit's remote control

- 1) Press the “operation/stop” button. (Operation will start.)
 - 2) Press the temperature ▲▼ button and the “operation select” button at the same time.
 - 3) Press the “operation select” button twice. (T will be displayed and the unit will enter test run mode.)
 - 4) Press the “operation select” button to return the operation mode to cooling.
- Test run mode will stop automatically after around 30 minutes. To force a test run to stop, press the operation/stop button.

CAUTION

After closing the liquid stop valve, close the gas stop valve within 3 minutes, then stop the forced operation.

Wiring

⚠ WARNING

- 1) Do not use spliced wires, strand wires, extension cords, or starburst connections, as they may cause overheating, electrical shock, or fire. Follow all Local, and State electrical codes.
- 2) Do not use locally purchased electrical parts inside the product. (Do not overload the circuit by adding drain pump or other electrical equipment to unit terminals.) Doing so may cause electric shock or fire.
- 3) Be sure to install an earth leak detector. (One that can handle higher harmonics.)
(This unit uses an inverter, which means that it must be used an earth leak detector capable handling harmonics in order to prevent malfunctioning of the earth leak detector itself.)
- 4) When carrying out wiring connection, take care not to pull at the conduit.

- Do not turn ON the safety breaker until all work is completed.

- 1) Strip the insulation from the wire (3/4 inch).
- 2) Connect the connection wires between the indoor and outdoor units **so that the terminal numbers match**. Tighten the terminal screws securely. We recommend a flathead screwdriver be used to tighten the screws. The screws are packed with the terminal board.

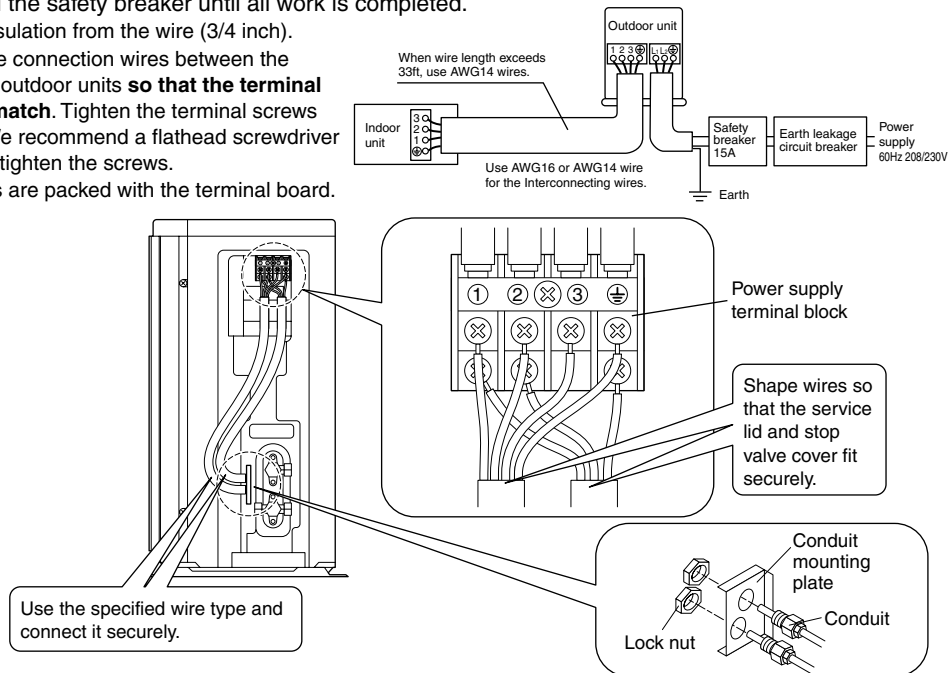

Observe the notes mentioned below when wiring to the power supply terminal board.

Precautions to be taken for power supply wiring.

(Use a round crimp-style terminal for connection to the power supply terminal board. In case it cannot be used due to unavoidable reasons, be sure to observe the following instruction.)

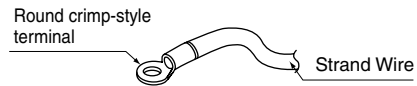

⚠ CAUTION

When connecting the connection wires to the terminal block using a single core wire, be sure to perform curling. Problems with the work may cause heat and fires.

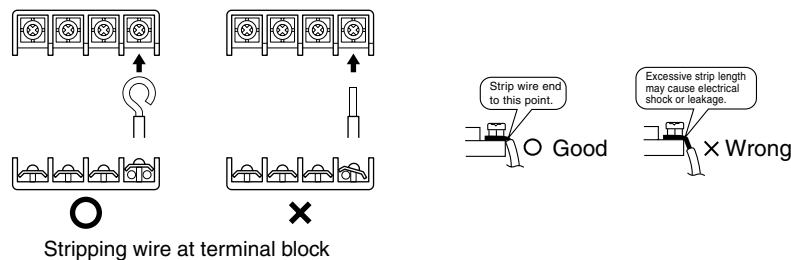

- 3) Pull the wire and make sure that it is tight. Then fix the wire in place with a strain relief.

Run Test and Final Check

1. Trial Operation and Testing.

1-1 Measure the supply voltage and make sure that it falls in the specified range.

1-2 Trial operation should be carried out in either cooling or heating mode.

- In cooling mode, select the lowest programmable temperature; in heating mode, select the highest programmable temperature.
 - 1) Trial operation may be disabled in either mode depending on the room temperature.
 - 2) After trial operation is complete, set the temperature to a normal level (78°F to 82°F in cooling mode, 68°F to 75°F in heating mode).
 - 3) For protection, the unit disables restart operation for 3 minutes after it is turned off.

1-3 Carry out the test operation in accordance with the Operation Manual to ensure that all functions and parts, such as louver movement, are working properly.

- The air conditioner requires a small amount of power in its standby mode. If the system is not to be used for some time after installation, shut off the circuit breaker to eliminate unnecessary power consumption.
- If the circuit breaker trips to shut off the power to the air conditioner, the system will restore the original operation mode when the circuit breaker is opened again.

2. Test Items.

Test Items	Symptom (diagnostic display on RC)	Check
Indoor and outdoor units are installed properly on solid bases.	Fall, vibration, noise	
No refrigerant gas leaks.	Incomplete cooling/heating function	
Refrigerant gas and liquid pipes and indoor drain hose extension are thermally insulated.	Water leakage	
Drain line is properly installed.	Water leakage	
System is properly grounded.	Electrical leakage	
The specified wires are used for interconnecting wire connections.	Inoperative or burn damage	
Indoor or outdoor unit's air intake or exhaust has clear path of air. Stop valves are opened.	Incomplete cooling/heating function	
Indoor unit properly receives remote control commands.	Inoperative	

11.2.3 15/18/24 Class

Accessories

Accessories supplied with the outdoor unit:

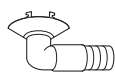
(A) Installation manuals	1	(B) Drain plug (Heat pump-Models)  Located on the bottom of the packing case.	1
--------------------------	---	---	---

Precautions for Selecting the Location

- 1) Choose a place strong enough to bear the weight and vibration of the unit. The location should not amplify operation sounds of the unit.
- 2) Choose a location where the hot air discharged from the unit and operation sounds do not bother neighbors.
- 3) Avoid noise sensitive locations such as bedrooms to avoid future problems.
- 4) There must be sufficient clearance for carrying the unit into and out of the site.
- 5) There must be sufficient space around the air inlet and the air outlet with no obstructions to airflow.
- 6) The surrounding area must be free from the possibility of flammable gas leakage.
- 7) Install units, power cords and inter-connecting cables at least 10 feet away from television and radio sets. This is to prevent interference to images and sounds. (Noises may be heard even if they are more than 10 feet away depending on radio wave conditions.)
- 8) In coastal areas or other places with salty atmosphere of sulfate gas, corrosion may shorten the life of the air conditioner.
- 9) Do not place moisture sensitive equipment or articles under the outdoor unit condensate drain.

NOTE

Do not install unit by hanging from a ceiling or stacking units.

⚠ Caution

When operating the air conditioner in a outdoor temperature below, be sure to follow the instructions described below.

- 1) To prevent exposure to wind, install the outdoor unit with its suction side facing the wall.
- 2) Never install the outdoor unit at a site where the suction side may be exposed directly to wind.
- 3) To prevent exposure to wind, it is recommended to install a baffle plate on the air discharge side of the outdoor unit.
- 4) In heavy snowfall areas, select an installation site where the snow will not affect the unit.

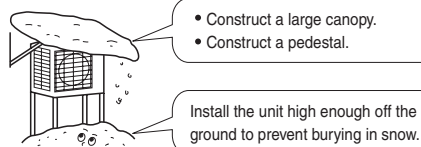

Precautions on Installation

- Ensure the strength and level of the installation will not cause any operating vibration or noise after installed.
- In accordance with the foundation drawing, fix the unit securely by means of the foundation bolts. (Prepare four sets of 3/8" or 7/16" foundation bolts, nuts and washers each which are available on the market.)
- It is best to screw in the foundation bolts until their length are 3/4" from the foundation surface.

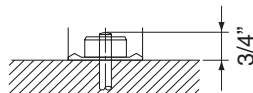

Outdoor Unit Installation Drawings

Model	15 class	18 class	24 class
Max. allowable length	98.4 ft		
Min. allowable length	4.9 ft		
Max. allowable height	65.6 ft		
Additional refrigerant required for refrigerant pipe exceeding 33 ft in length.	0.22 oz/ft		
Gas pipe	O.D. 1/2"	O.D. 5/8"	
Liquid pipe	O.D. 1/4"		

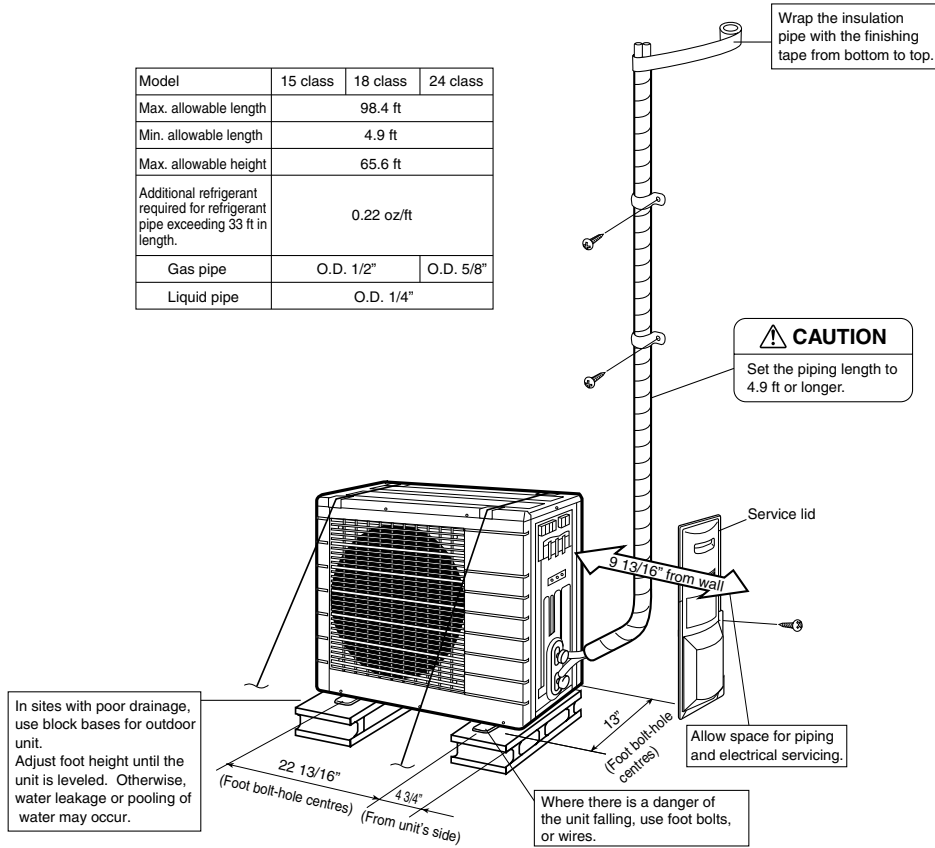

Installation Guidelines

- Where a wall or other obstacle is in the path of outdoor unit's intake or exhaust airflow, follow the installation guidelines below.
- For any of the below installation patterns, the wall height on the exhaust side should be 4 ft or less.

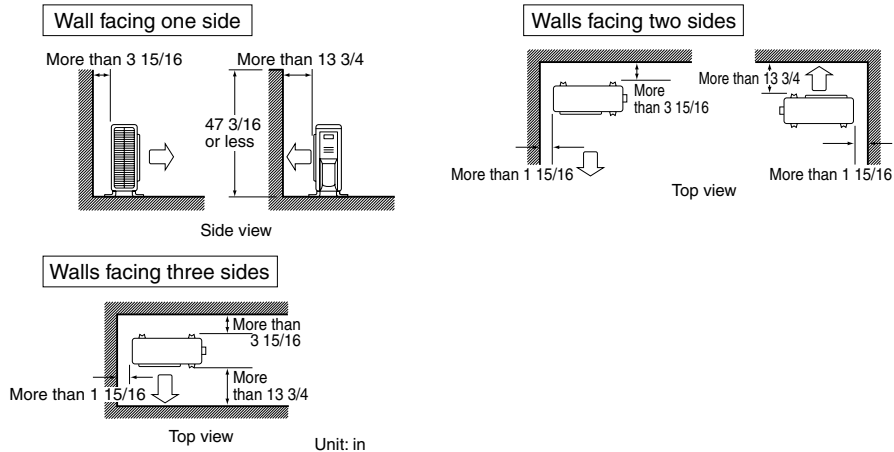

Outdoor Unit Installation

1. Installing Outdoor Unit

- 1) When installing the outdoor unit, refer to "Precautions for Selecting the Location" and the "Outdoor Unit Installation Drawings."
- 2) If drain work is necessary, follow the procedures below.

2. Drain Work

- 1) Use drain plug for drainage.
- 2) If the drain port is covered by a mounting base or floor surface, place additional foot bases of at least 1 1/4" in height under the outdoor unit's feet.
- 3) In cold areas, do not use a drain hose with the outdoor unit.
(Otherwise, drain water may freeze, impairing heating performance.)

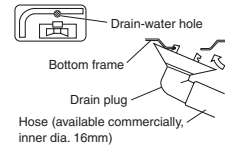

3. Flaring the Pipe End

- 1) Cut the pipe end with a pipe cutter.
- 2) Remove burrs with the cut surface facing downward so that the chips do not enter the pipe.
- 3) Put the flare nut on the pipe.
- 4) Flare the pipe.
- 5) Check that the flaring is properly made.

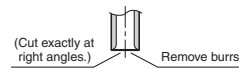

Flaring

Set exactly at the position shown below.

Die	Flare tool for R-410A		Conventional flare tool	
	Clutch-type	Clutch-type (Rigid-type)	Wing-nut type (Imperial-type)	
A	0 - 0.020"	0.039 - 0.059"	0.059 - 0.079"	

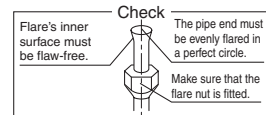

⚠ Warning

- 1) Do not use mineral oil on flared part.
- 2) Prevent mineral oil from getting into the system as this would reduce the unit life.
- 3) Never use piping which has been used for previous installations. Only use parts which are provided with the unit.
- 4) Never install a refrigerant drier to this unit.
- 5) The drying material may dissolve and damage the system.
- 6) Incomplete or improper flaring may cause refrigerant gas leakage.

4. Refrigerant Piping

⚠ Caution

- 1) Use the flare nut fixed to the main unit to prevent cracking from deterioration.
- 2) To prevent gas leakage, apply refrigeration oil only to the inner surface of the flare. (Use refrigeration oil for R410A.)
- 3) Use torque wrenches when tightening the flare nuts to prevent damage to the flare nuts and gas leakage.

Align the centers of both flares and tighten the flare nuts 3 or 4 turns by hand. Then tighten them fully with the torque wrenches.

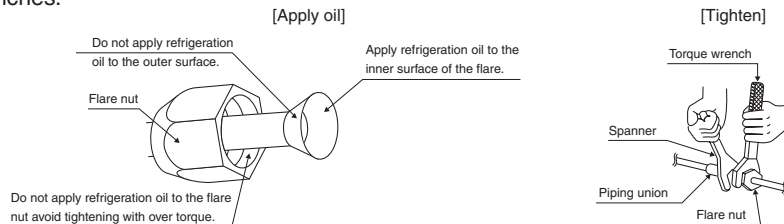

Flare nut tightening torque		
Gas side		Liquid side
1/2 inch	5/8 inch	1/4 inch
36.5~44.5ft • lbf	45.6~55.6ft • lbf	10.4~12.7ft • lbf

Valve cap tightening torque		
Gas side		Liquid side
1/2 inch	5/8 inch	1/4 inch
35.5~44.0ft • lbf	32.5~39.7ft • lbf	15.9~20.2ft • lbf

Service port cap tightening torque	7.9~10.8ft • lbf
------------------------------------	------------------

Outdoor Unit Installation

5. Purging Air and Checking for Gas Leakage

- When the piping work is completed, it is necessary to purge the air and check for gas leakage.

Warning

- Do not place any substance other than the specified refrigerant (R410A) into the refrigeration cycle.
- When a refrigerant gas leak occurs, ventilate the room as soon and as much as possible.
- R410A, as well as other refrigerants, should always be recovered and never be released directly into the environment.
- Use a vacuum pump for R410A exclusively. Using the same vacuum pump for different refrigerants may damage the vacuum pump or the unit.

- If adding additional refrigerant, perform air purging from the refrigerant pipes and indoor unit using a vacuum pump before charging additional refrigerant.
- Use a hexagonal wrench (3/16") to operate the shut-off valve rod.
- All refrigerant pipe joints should be tightened with a torque wrench to the specified tightening torque.

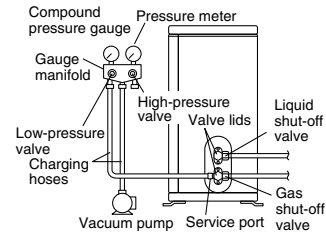

- 1) Connect projection side (on which worm pin is pressed) of charging hose (which comes from gauge manifold) to gas shut-off valve's service port.
- ↓
- 2) Fully open gauge manifold's low-pressure valve (Lo) and completely close its high-pressure valve (Hi). (High-pressure valve subsequently requires no operation.)
- ↓
- 3) Do vacuum pumping and make sure that the vacuum pressure gauge reads - 29.9 inHg *1.
- ↓
- 4) Close gauge manifold's low-pressure valve (Lo) and stop vacuum pump. (Keep this state for a few minutes to make sure that the vacuum pressure gauge pointer does not swing back.)*2.
- ↓
- 5) Remove valve lids from liquid shut-off valve and gas shut-off valve.
- ↓
- 6) Turn the liquid shut-off valve's rod 90 degrees counterclockwise with a hexagonal wrench to open valve. Close it after 5 seconds, and check for gas leakage. Using soapy water, check for gas leakage from indoor unit's flare and outdoor unit's flare and valve rods. After the check is complete, wipe all soapy water off.
- ↓
- 7) Disconnect charging hose from gas shut-off valve's service port, then fully open liquid and gas shut-off valves. (Do not attempt to turn valve rod beyond its stop.)
- ↓
- 8) Tighten valve lids and service port cap for the liquid and gas shut-off valves with a torque wrench at the specified torques.

*1. Pipe length vs. vacuum pump run time

Pipe length	Up to 50 feet	More than 50 feet
Run time	Not less than 10 min.	Not less than 15 min.

*2. If the vacuum pressure gauge pointer swings back, refrigerant may have water content or a loose pipe joint may exist. Check all pipe joints and retighten nuts as needed, then repeat steps 2) through 4).

Outdoor Unit Installation

6. Refilling The Refrigerant

Check the type of refrigerant to be used on the machine nameplate.

Precautions when adding R410A

Fill from the liquid pipe in liquid form.

It is a mixture of refrigerant, so adding it in gas form may cause the refrigerant composition to change, preventing normal operation.

- 1) Before filling, check whether the cylinder has a siphon attached or not. (It should have something like "liquid filling siphon attached" displayed on it.)

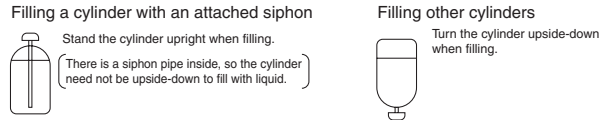

- Be sure to use the R410A tools to ensure pressure and to prevent foreign objects entering.

7. Refrigerant Piping Work

7-1 Cautions on Pipe Handling

- 1) Protect the open end of the pipe against dust and moisture.
- 2) All pipe bends should be as gentle as possible. Use a pipe bender for bending.

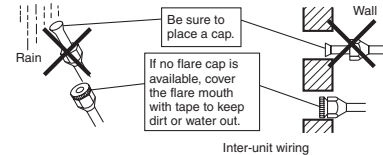

7-2 Selection of Copper and Heat Insulation materials

When using commercial copper pipes and fittings, observe the following:

- 1) Insulation material: Polyethylene foam
Heat transfer rate: 0.041 to 0.052 W/mK (0.024-0.030 Btu/ft²°F)
Choose heat insulation materials that are designed for HVAC use.

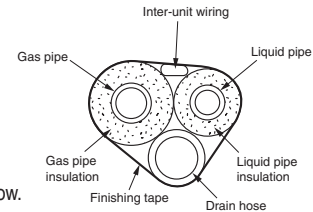

- 2) Be sure to insulate both the gas and liquid piping and to provide insulation dimensions as below.

Gas side		Liquid side	Gas pipe thermal insulation		Liquid pipe thermal insulation	
15/18 class	24 class	15/18/24 class	15/18 class	24 class	15/18/24 class	
O.D. 1/2 inch (12.7mm)	O.D. 5/8 inch (15.9mm)	O.D. 1/4 inch (6.4mm)	I.D. 0.551-0.630 inch (14-16mm)	I.D. 0.630-0.709 inch (16-20mm)	I.D. 0.315-0.393 inch (8-10mm)	
Minimum bend radius			Thickness 0.393 inch (8mm) Min.			
1-9/16 inch (40mm) or more	1-15/16 inch (50mm) or more	1-3/16 inch (30mm) or more				
Thickness 0.031 inch (0.8mm) (C1220T-O)	Thickness 0.039 inch (1.0mm) (C1220T-O)	Thickness 0.031 inch (0.8mm) (C1220T-O)				

- Use separate thermal insulation pipes for gas and liquid refrigerant pipes.

Pump Down Operation

In order to protect the environment, be sure to pump down when relocating or disposing of the unit.

- 1) Remove the valve lids from liquid shut-off valve and gas shut-off valve.
- 2) Carry out forced cooling operation.
- 3) After five to ten minutes, close the liquid shut-off valve with a hexagonal wrench.
- 4) After two to three minutes, close the gas shut-off valve and stop forced cooling operation.

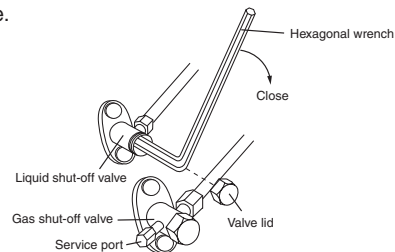

Forced cooling operation

- 1) Press the Forced Operation switch (SW1) to begin forced cooling. Press the Forced Operation switch (SW1) again to stop forced cooling.

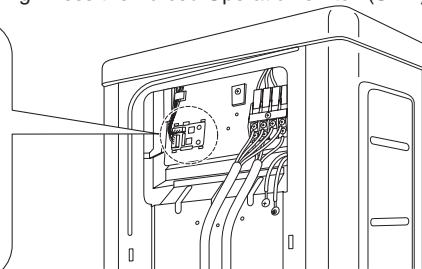
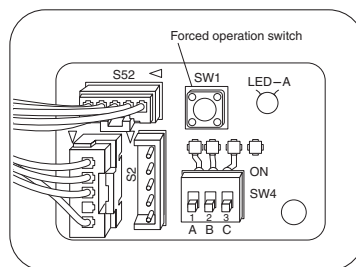

Wiring

⚠ Warning

- 1) Do not use spliced wires, stand wires, extension cords, or starburst connections, as they may cause overheating, electrical shock, or fire. Follow all Local, and State electrical codes.
- 2) Do not use locally purchased electrical parts inside the product. (Do not overload the circuit by adding drain pump or other electrical equipment to unit terminals.) Doing so may cause electric shock or fire.
- 3) Be sure to install a ground leak detector. (One that can handle higher harmonics.)
(This unit uses an inverter, which means that it must be used an gournd leak detector capable handling harmonics in order to prevent malfunctioning of the ground leak detector itself.)
- 4) When carrying out wiring connection, take care not to pull at the conduit.

• Do not turn ON the safety breaker until all work is completed.

- 1) Strip the insulation from the wire (3/4 in).
- 2) Connect the connection wires between the indoor and outdoor units **so that the terminal numbers match**. Tighten the terminal screws securely. We recommend a flathead screwdriver be used to tighten the screws. The screws are packed with the terminal board.

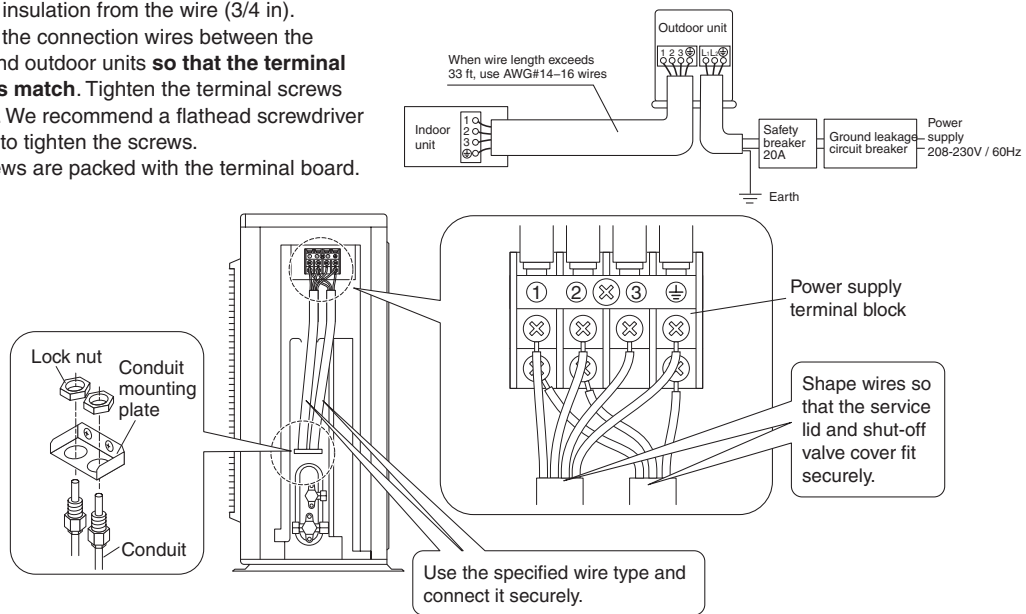

Observe the notes mentioned below when wiring to the power supply terminal board.

Precautions to be taken for power supply wiring.

(Use a round crimp-style terminal for connection to the power supply terminal board. In case it cannot be used due to unavoidable reasons, be sure to observe the following instruction.)

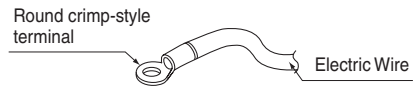

⚠ Caution

When connecting the connection wires to the terminal board using a single core wire, be sure to perform curling. Problems with the work may cause heat and fires.

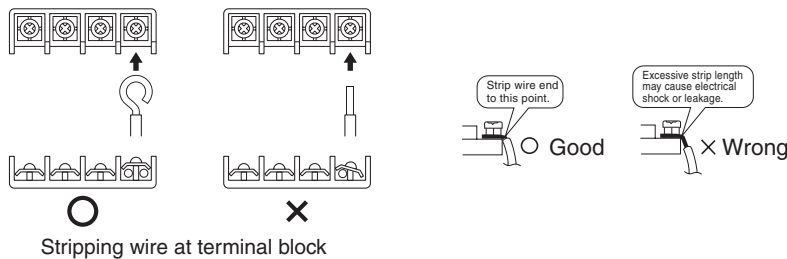

- 3) Pull the wire and make sure that it is tight. Then fix the wire in place with a strain relief.

Run Test and Final Check

1. Trial Operation and Testing.

1-1 Measure the supply voltage and make sure that it falls in the specified range.

1-2 Trial operation should be carried out in either cooling or heating mode.

- In cooling mode, select the lowest programmable temperature; in heating mode, select the highest programmable temperature.
 - 1) Trial operation may be disabled in either mode depending on the room temperature.
 - 2) After trial operation is complete, set the temperature to a normal level (78°F to 82°F in cooling mode, 68°F to 75°F in heating mode).
 - 3) For protection, the unit disables restart operation for 3 minutes after it is turned off.

1-3 Carry out the test operation in accordance with the Operation Manual to ensure that all functions and parts, are working properly.

- The air conditioner requires a small amount of power in its standby mode. If the system is not to be used for some time after installation, shut off the circuit breaker to eliminate unnecessary power consumption.
- If the circuit breaker trips to shut off the power to the air conditioner, the system will restore the original operation mode when the circuit breaker is opened again.

2. Test Items.

Test Items	Symptom	Check
Indoor and outdoor units are installed properly on solid bases.	Fall, vibration, noise	
No refrigerant gas leaks.	Incomplete cooling/heating function	
Refrigerant gas and liquid pipes and indoor drain hose extension are thermally insulated.	Water leakage	
Drain line is properly installed.	Water leakage	
System is properly grounded.	Electrical leakage	
The specified wires are used for interconnecting wire connections.	Inoperative or burn damage	
Indoor or outdoor unit's air intake or exhaust has clear path of air. Shut-off valves are opened.	Incomplete cooling/heating function	
Indoor unit properly receives remote control commands.	Inoperative	





12. Operation Manual

12.1 Safety precautions

Safety Precautions

- Keep this manual where the operator can easily find it.
- Read this manual carefully before starting the unit.
- For safety reason, the operator must read the following cautions carefully.
- This manual classifies precautions into DANGER, WARNING and CAUTION. Be sure to follow all precautions below: they are all important for ensuring safety.





 DANGER	 WARNING	 CAUTION
Indicates an imminently hazardous situation which, if not avoided, will result in death or serious injury.	If you do not follow these instructions exactly, the unit may cause property damage, personal injury or loss of life.	If you do not follow these instructions exactly, the unit may cause minor or moderate property damage or personal injury.

 Never do.	 Be sure to follow the instructions.
 Be sure to ground the air conditioner.	
 Never touch the air conditioner (including the remote controller) with a wet hand.	 Never cause the air conditioner (including the remote controller) to get wet.

DANGER

- For refrigerant leakage, consult your dealer.
Refrigerant gas is heavier than air and replaces oxygen. A massive leak could lead to oxygen depletion, especially in basements, and an asphyxiation hazard could occur leading to serious injury or death.
- Refrigerant gas may produce a toxic gas if it comes in contact with fire such as from a fan heater, stove or cooking device. Exposure to this gas could cause severe injury or death.
- Any abnormalities in the operation of the air conditioner such as smoke or fire could result in severe injury or death. Turn off the power and contact your dealer immediately for instructions.
- Do not install the unit in an area where flammable materials are present due to risk of explosion resulting in serious injury or death.
- If equipment utilizing a burner is used in the same room as the air conditioner, there is the danger of oxygen deficiency which could lead to an asphyxiation hazard resulting in serious injury or death.
Be sure to ventilate the room sufficiently to avoid this hazard.
- Safely dispose of the packing materials.
Packing materials, such as nails and other metal or wooden parts, may cause stabs or other injuries. Tear apart and throw away plastic packaging bags so that children will not play with them. Children playing with plastic bags face the danger of death by suffocation.

WARNING

-  • Avoid exposure to airflow for long periods of time.
-  • Do not put your finger, a rod or other objects into the air outlet or inlet. As the fan is rotating at a high speed and could, cause injury. Always keep small children away from the unit during operation.
-  • Do not attempt to repair, relocate, modify or reinstall the air conditioner by yourself. Incorrect work or modifications could cause electric shocks, fire or other damage.
For repairs and reinstallation, consult your Daikin dealer for advice and information.
-  • If the air conditioner is not cooling (heating) properly, the refrigerant may be leaking, contact your authorized dealer or qualified service repairman.
When making repairs which requires adding refrigerant, consult with your authorized dealer or qualified service repairman.
-  • Do not attempt to install the air conditioner by yourself. Improper installation could result in water leakage, electric shocks or fire. For installation, consult your authorized dealer or a qualified technician.

CAUTION



- The air conditioner must be grounded to the earth. Improper grounding may result in electric shocks. Do not connect the earth grounding wire to a gas pipe, water pipe, lightning rod, or a telephone ground line. Follow all local and state electrical codes.



- Do not use this unit for cooling precision instruments, food, plants, animals or works of art.
- Avoid direct exposure to airflow.
- Do not block air inlets nor outlets. Impaired air flow may result in poor performance or equipment problems.
- Do not stand, sit, or place objects on the outdoor unit. To avoid injury, do not remove the fan guard.
- Do not place anything under the indoor or outdoor unit that must be kept away from moisture, such as electrical or electronic equipment. In certain conditions, moisture in the air may condense and drip.
- Check the unit stand and fittings for damage annually.
- Do not touch the air inlet and aluminum fins of outdoor unit. It may cause injury and/or damage the heat transfer surface.
- This appliance is NOT intended for use by young children or impaired persons without proper supervision.
- Keep unit free of leaves and insects that can cause malfunction or electrical fire.
- Do not pull at the conduit or hang anything on it. Otherwise it will cause fire or electric shock.
- Do not touch the heat exchanger fins. Improper handling may result in injury.
- Do not turn off the power immediately after stopping operation. Always wait at least five minutes before turning off the power. Otherwise, water leakage and trouble may occur.



- To avoid personal injury or equipment damage be sure to stop the operation, turn the breaker off or pull out the supply cord before cleaning or servicing the unit. NOTE: More than one disconnect may be required to shut off all power.
- Do not connect the air conditioner to a power supply different from the one specified. It may cause improper operation or fire.
- Depending on the environment, state and local electrical codes, a ground fault circuit interrupter may be required. Improper grounding or lack of a ground fault circuit interrupter may result in electrical shock, injuries, or death.
- Arrange the drain hose to ensure smooth drainage. Improper drainage may cause water damage to the building, or it's furnishing.
- Depending on the usage environment, water may leak from the air conditioner. If this happens, contact your Daikin Dealer.
- The remote controller should be installed in such away that children cannot play with it.
- Do not place objects in direct proximity of the outdoor unit and do not let leaves and other debris accumulate around the unit.



- Do not operate the air conditioner with wet hands.



- Do not wash the indoor unit with excessive water, only use a slightly wet cloth.
- Do not place things such as vessels containing water or anything else on top of the unit. Water may penetrate into the unit and degrade electrical insulations, resulting in an electric shock.

Installation site.

- To install the air conditioner in the following types of environments, consult the dealer.
 - Places with an oily ambient or where steam or soot occurs.
 - Salty environment such as coastal areas.
 - Places where sulfide gas occurs such as hot springs.
 - Places where snow may block the outdoor unit. The drain from the outdoor unit must be discharged to a place of good drainage.

Consider nuisance to your neighbours from noises.

- For installation, choose a place as described below.
 - A place solid enough to bear the weight of the unit which does not amplify the operation noise or vibration.
 - A place from where the air discharged from the outdoor unit or the operation noise will not annoy your neighbours.

Electrical work.

- For power supply, be sure to use a separate power circuit dedicated to the air conditioner.

System relocation.

- Relocating the air conditioner requires specialized knowledge and skills. Please consult the dealer if relocation is necessary for moving or remodeling.

12.2 09/12 Class

Name of Parts

Indoor Unit

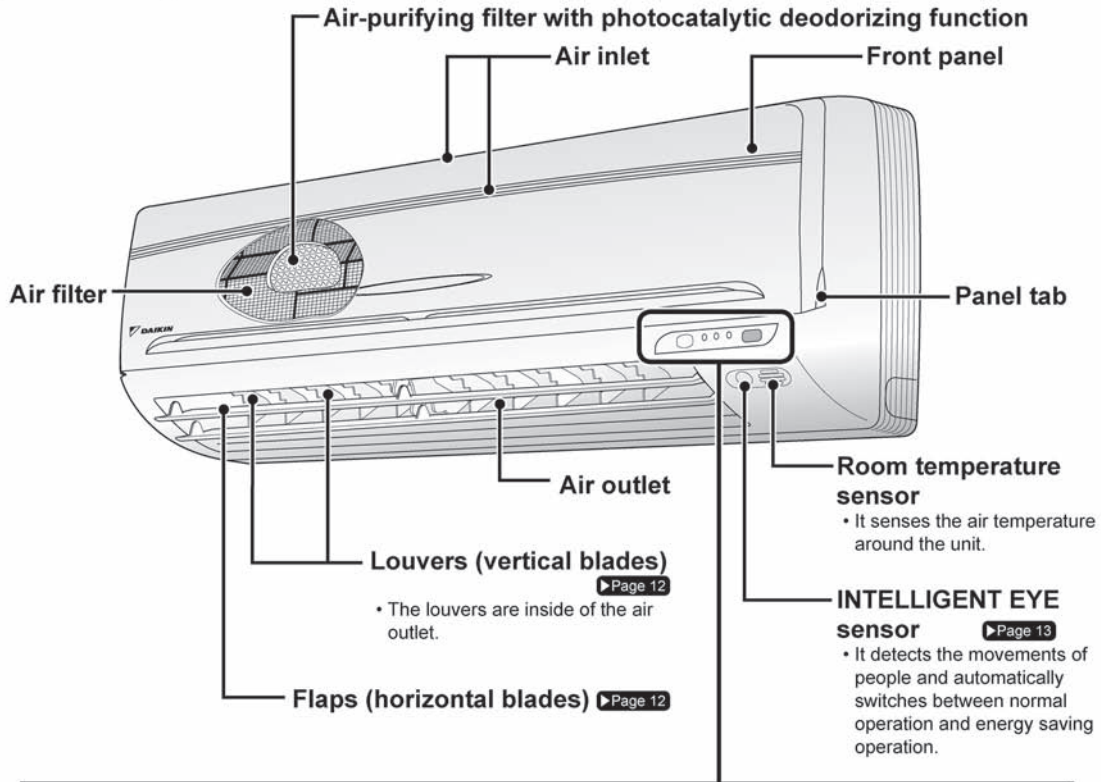

Control panel

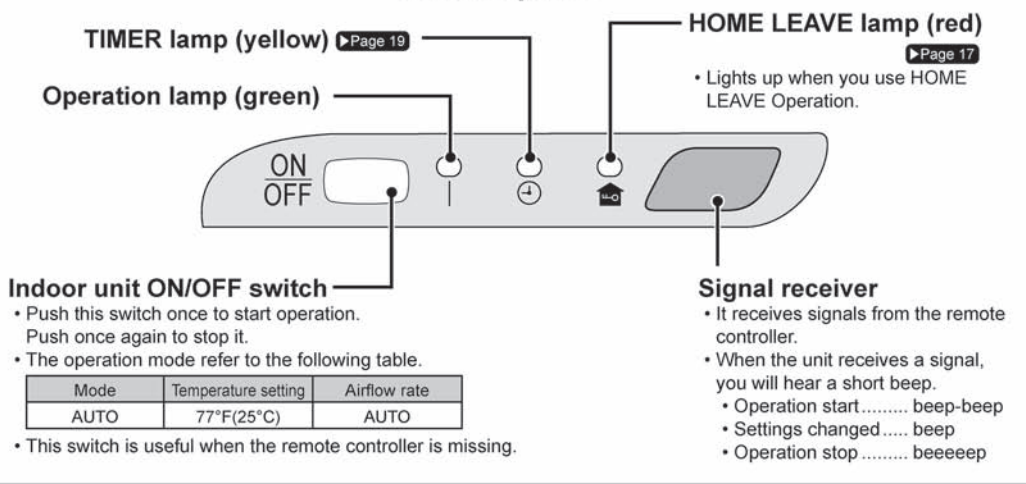

Open the front panel

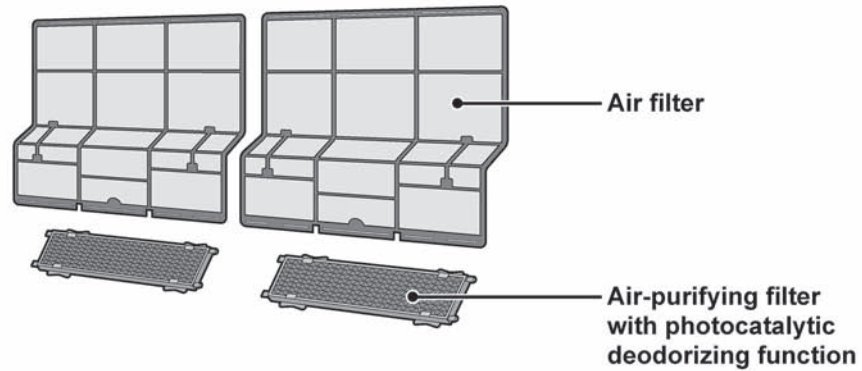
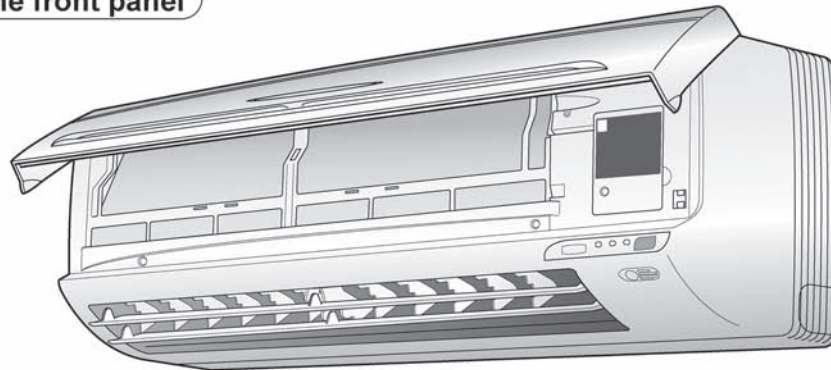

Outdoor Unit

• Appearance of the outdoor unit may differ from some models.

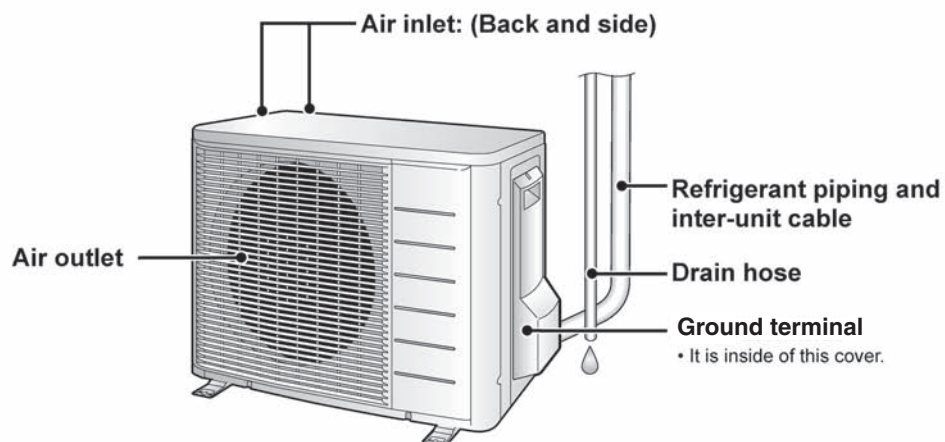

Name of Parts

Remote Controller: ARC452A7

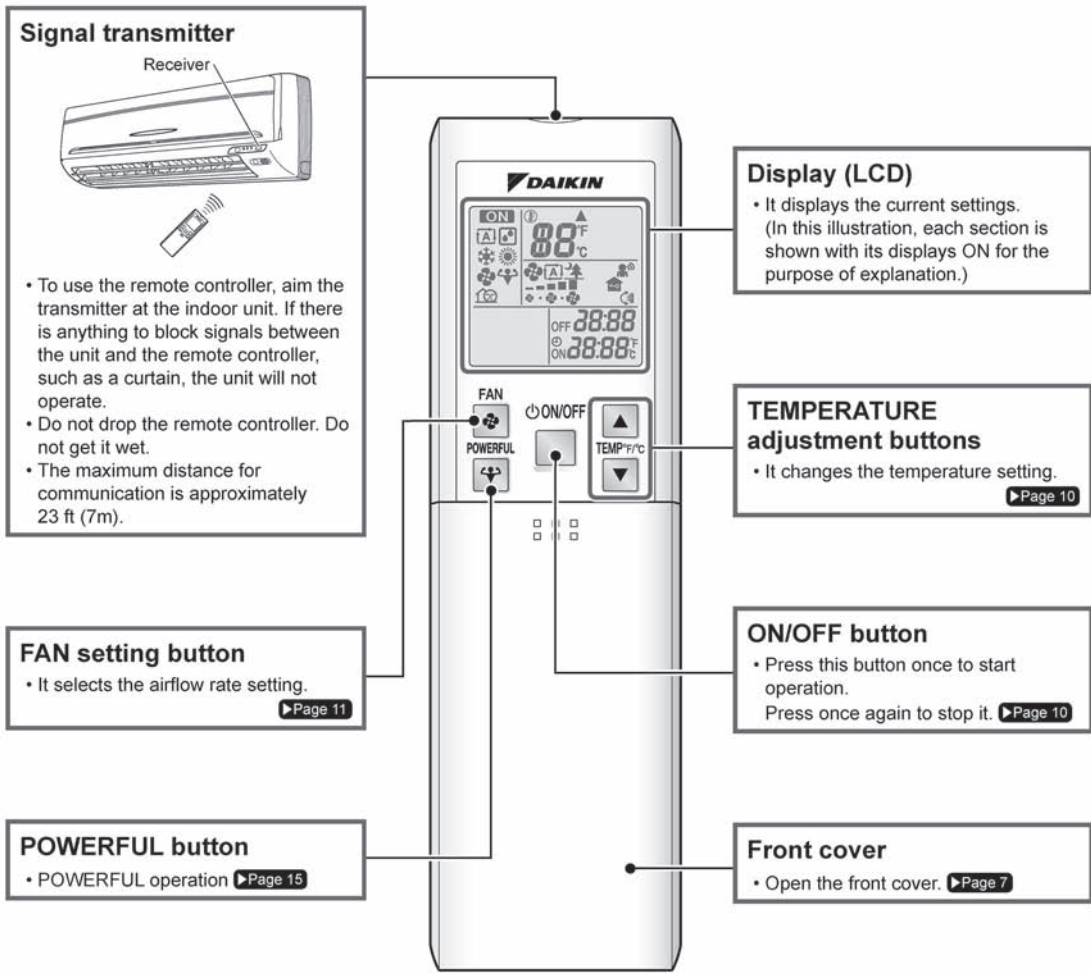

Open the front cover

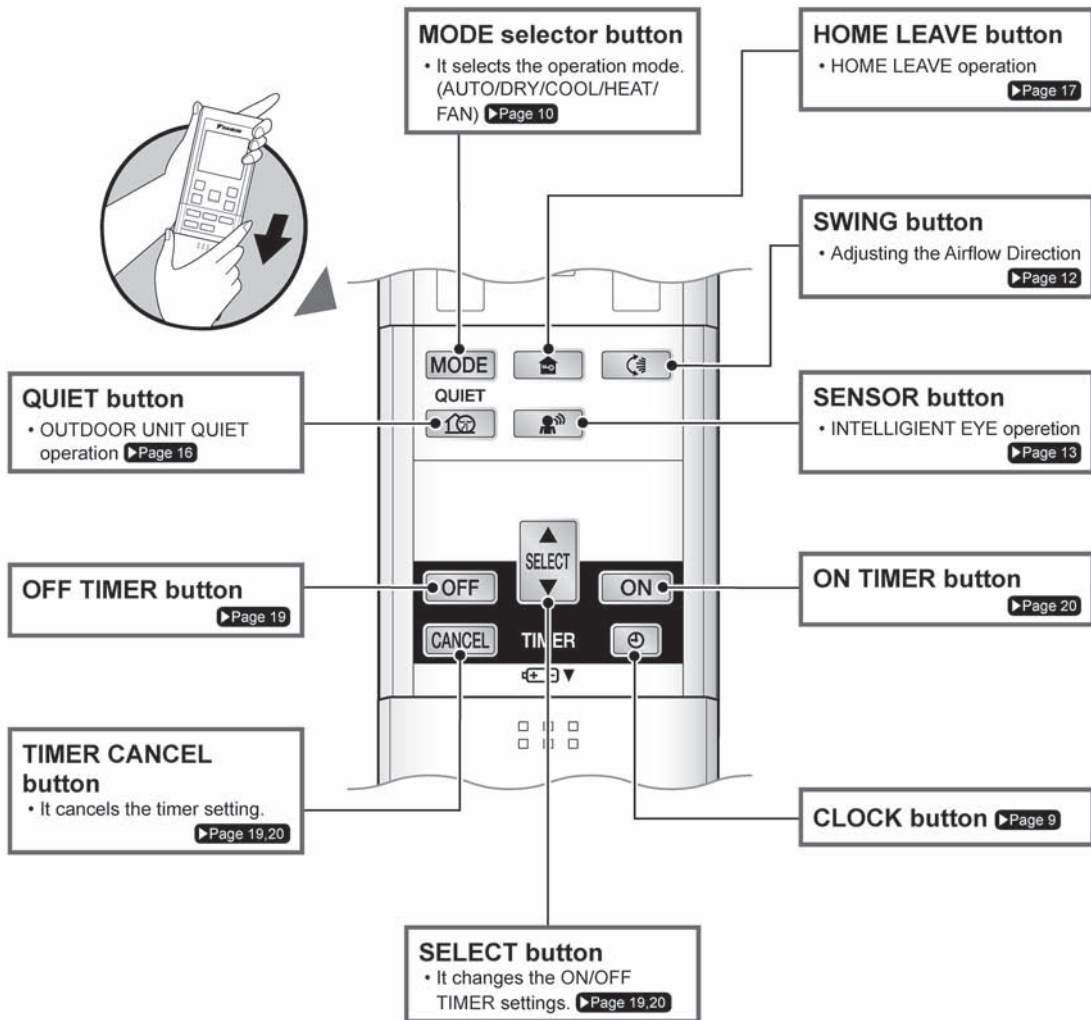

Preparation before Operation

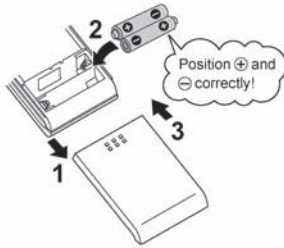

■ To set the batteries

1. Slide the front cover to take it off.
2. Set 2 dry batteries AAA.LR03 (alkaline).
3. Set the front cover as before.

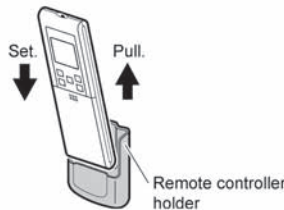

■ To fix the remote controller holder on the wall

1. Choose a place from where the signals reach the unit.
2. Fix the holder to a wall, a pillar, etc. with the screws supplied with the holder.
3. Place the remote controller in the remote controller holder.

■ Celsius/Fahrenheit display switch

- The Celsius or Fahrenheit display is selectable with the following buttons.

Press  and  buttons simultaneously for 5 seconds.

- The temperature will be displayed in Fahrenheit if it is presently displayed in Celsius, and vice versa.

ATTENTION

■ About batteries

- When replacing the batteries, use batteries of the same type, and replace the 2 old batteries together.
- When the system is not used for a long time, take the batteries out.
- The batteries will last for approximately 1 year. If the remote controller display begins to fade and the degradation of reception performance occurs within a year, however, replace both 2 batteries with new, size AAA.LR03 (alkaline).
- The attached batteries are provided for the initial use of the system.
The usable period of the batteries may be short depending on the manufactured date of the air conditioner.

■ About remote controller

- Never expose the remote controller to direct sunlight.
- Dust on the signal transmitter or receiver will reduce the sensitivity. Wipe off dust with soft cloth.
- Signal communication may be disabled if an electronic-starter-type fluorescent lamp (such as inverter-type lamps) is in the room. Consult the shop if that is the case.
- If the remote controller signals happen to operate another appliance, move that appliance to somewhere else, or consult the service shop.

■ Celsius/Fahrenheit display change function of remote controller

- The set temperature may increase when the display is changed to Celsius from Fahrenheit, because a fraction of 0.5°C is rounded up.
- Example: A set temperature of 64°F (equivalent to 18.5°C) will be converted into 19°C.
When the display is changed to Fahrenheit again, the set temperature will be converted into 66°F (equivalent to 19°C) instead of the original set temperature (64°F) but a set temperature of 66°F (equivalent to 19°C) will be converted into 19°C with no temperature change.
- A reception sound will go off for the transmission of set temperature to the indoor unit at the time of setting the Celsius/Fahrenheit display change function.

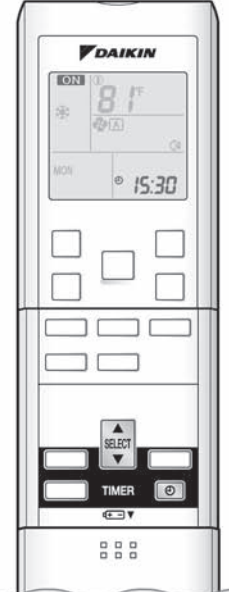



■ Turn the breaker ON
 • Turning ON the breaker closes the flap. (This is a normal procedure.)



■ To set the clock

- 1. Press** .

 "0:00" is displayed.
 "MON" and "⏻" blinks.

- 2. Press**  **to set the current day of the week.**
- 3. Press** .

 "⏻" blinks.

- 4. Press**  **to set the clock to the present time.**
 • Holding down  button rapidly increases or decreases the time display.
- 5. Press** .

 " ." blinks.

NOTE

■ Tips for saving energy

- Be careful not to COOL (HEAT) the room too much.
 Keeping the temperature setting at a moderate level helps save energy.
- Cover windows with a blind or a curtain.
 Blocking sunlight and air from outdoors increases the cooling (heating) effect.
- Clogged air filters cause inefficient operation and waste energy. Clean them once in about every two weeks.

Recommended temperature setting
For COOL: 78°F – 82°F (26°C – 28°C)
For HEAT: 68°F – 75°F (20°C – 24°C)

■ Please note

- The air conditioner always consumes 50-120 btu/h (15-35 watts) of electricity even while it is not operating.
- If you are not going to use the air conditioner for a long period, for example in spring or autumn, turn the breaker OFF.
- Use the air conditioner in the following conditions.

Mode	Operating conditions	If operation is continued out of this range
COOL	Outdoor temperature : 14 to 115°F (-10 to 46°C) Indoor temperature : 64 to 90°F (18 to 32°C) Indoor humidity : 80% max.	<ul style="list-style-type: none"> • A safety device may work to stop the operation. Under 0°F and over 115°F outdoor temperature. • See Note 2 for 0°F to 14°F operation. • Condensation may occur on the indoor unit and drip.
HEAT	Outdoor temperature : 5 to 64°F (-15 to 18°C) Indoor temperature : 50 to 86°F (10 to 30°C)	<ul style="list-style-type: none"> • A safety device may work to stop the operation. Under 0°F or over 64°F outdoor temperature. • See the Note 3 for 0°F to 5°F.
DRY	Outdoor temperature : 14 to 115°F (-10 to 46°C) Indoor temperature : 64 to 90°F (18 to 32°C) Indoor humidity : 80% max.	<ul style="list-style-type: none"> • A safety device may work to stop the operation. • Condensation may occur on the indoor unit and drip.

- Operation outside this humidity or temperature range may cause a safety device to disable the system.

AUTO · DRY · COOL · HEAT · FAN Operation

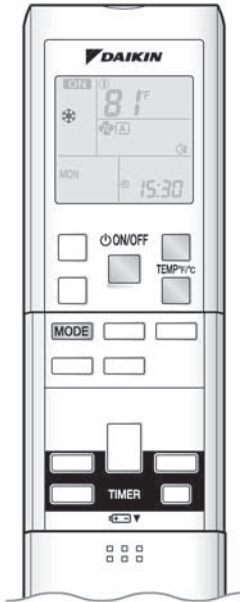

The air conditioner operates with the operation mode of your choice.
From the next time on, the air conditioner will operate with the same operation mode.

■ To start operation

1. Press **MODE** and select a operation mode.

- Each pressing of the button advances the mode setting in sequence.

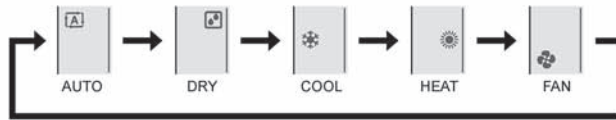

2. Press .

- "ON" is displayed on the LCD.
- The OPERATION lamp lights up.

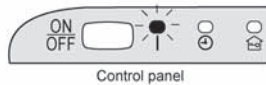

■ To stop operation

Press  again.

- "ON" is displayed on the LCD.
- Then OPERATION lamp goes off.

■ To change the temperature setting

Press  or .

- The displayed items on the LCD will change whenever either one of the buttons is pressed.

DRY or FAN mode	COOL mode	HEAT mode	AUTO mode
The temperature setting is not variable.	64~90°F (18~32°C)	50~86°F (10~30°C)	64~86°F (18~30°C)
Press ▲ to raise the temperature and press ▼ to lower the temperature.			

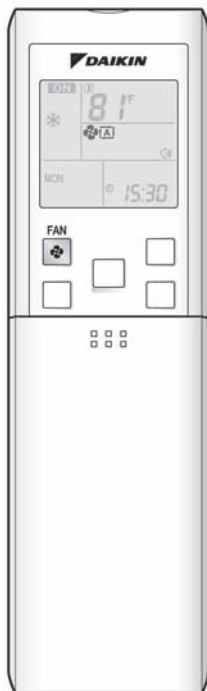

■ To change the airflow rate setting

Press .

DRY mode	AUTO or COOL or HEAT or FAN mode
The airflow rate setting is not variable.	Five levels of airflow rate setting from  to  plus "[A]" and  are available. 

- Indoor unit quiet operation
When the airflow is set to , the noise from the indoor unit will become quieter. Use this when making the noise quieter. The unit might lose capacity when the airflow rate is set to a weak level.
- Each pressing of the button advances the airflow rate setting in sequence.



NOTE

■ Note on HEAT operation

- Since this air conditioner heats the room by taking heat from outdoor air to indoors, the heating capacity becomes smaller in lower outdoor temperatures. If the heating effect is insufficient, it is recommended to use another heating appliance in combination with the air conditioner.
- The heat pump system heats the room by circulating hot air around all parts of the room. After the start of HEAT operation, it takes some time before the room gets warmer.
- In HEAT operation, frost may occur on the outdoor unit and lower the heating capacity. In that case, the system switches into defrosting operation to take away the frost.
- During defrosting operation, hot air does not flow out of indoor unit.

■ Note on COOL operation

- This air conditioner cools the room by blowing the hot air in the room outside, so if the outside temperature is high, the performance of the air conditioner drops.

■ Note on DRY operation

- The computer chip works to rid the room of humidity while maintaining the temperature as much as possible. It automatically controls temperature and airflow rate, so manual adjustment of these functions is unavailable.

■ Note on AUTO operation

- In AUTO operation, the system selects a temperature setting and an appropriate operation mode (COOL or HEAT) based on the room temperature at the start of the operation.
- The system automatically reselects setting at a regular interval to bring the room temperature to user-setting level.
- If you do not like AUTO operation, manually change the set temperature.

■ Note on FAN operation

- This is valid for fan only.

■ Note on airflow rate setting

- At smaller airflow rates, the cooling (heating) effect is also smaller.

Adjusting the Airflow Direction

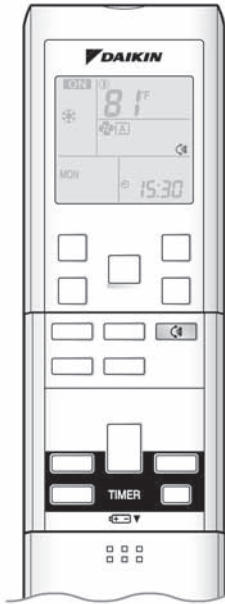

You can adjust the airflow direction to increase your comfort.

Adjusting the upper and lower airflow direction

■ To adjust the fins (horizontal blades)

1. Press .

- "☺" is displayed on the LCD and the flaps will begin to swing.

2. When the fins have reached the desired position, press  once more.

- The flaps will stop moving.
- "☺" disappears from the LCD.

Adjusting the right and left airflow direction

■ To adjust the louvers (vertical blades)

- Hold the knob and move the louvers.
(You will find a knob on the left-side and the right-side blades.)

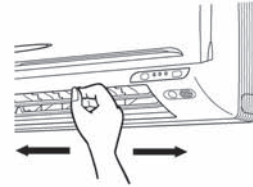

NOTE

■ Notes on flaps and louvers angles

- When "SWING button" is selected, the fins swinging range depends on the operation mode.
(See the figure.)

Three-Dimensional (3-D) Airflow

- Using three-dimensional airflow circulates cold air, which tends to be collected at the bottom of the room, and hot air, which tends to collect near the ceiling, throughout the room, preventing areas of cold and hot developing.

■ ATTENTION

- Always use a remote controller to adjust the angles of the fins and louvers. If you attempt to move it forcibly by hand when it is swinging, the mechanism may break.
- Always use a remote controller to adjust the louvers angles. Inside the air outlet, a fan is rotating at a high speed.

COOL AND DRY MODE

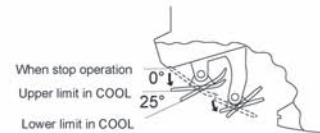

HEAT AND FAN MODE

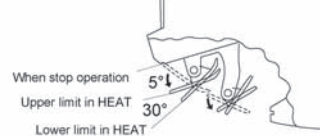

INTELLIGENT EYE Operation

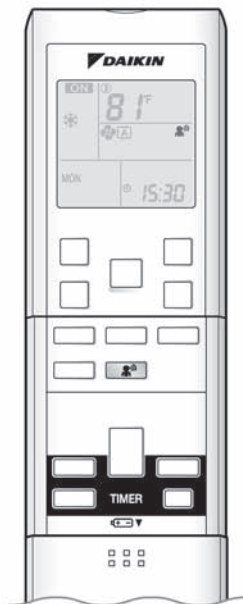

"INTELLIGENT EYE" is the infrared sensor which detects the human movement.

■ To start INTELLIGENT EYE operation

1. Press  .

- "  " displayed on the LCD.

■ To cancel the INTELLIGENT EYE operation

2. Press  again.

- "  " disappears from the LCD.

[EX.]

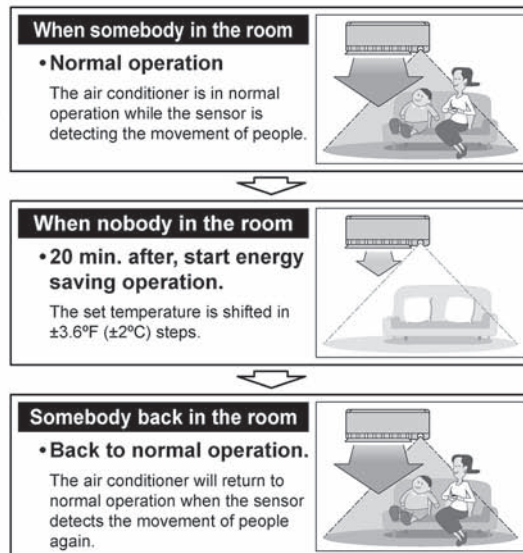

INTELLIGENT EYE Operation

■ To adjust the angle of the INTELLIGENT EYE sensor

- You can adjust the angle of the INTELLIGENT EYE sensor to increase the detection area.
(Adjustable angle: 15° to right and left of center)

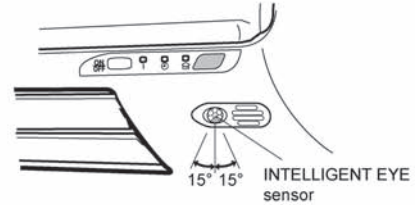

- Gently push and slide the sensor to adjust the angle.
- After adjusting the angle, wipe the sensor gently with a clean cloth, being careful not to scratch the sensor.



Moving the sensor to the left Moving the sensor to the right

“INTELLIGENT EYE” is useful for Energy Saving

■ Energy saving operation

- Change the temperature -3.6°F (-2°C) in HEAT / $+3.6^{\circ}\text{F}$ ($+2^{\circ}\text{C}$) in COOL / $+1.8^{\circ}\text{F}$ ($+1^{\circ}\text{C}$) in dry mode from set temperature.
- Decrease the airflow rate slightly in FAN mode only.
- If no presence detected in the room for 20 minutes.

NOTE

■ Notes on “INTELLIGENT EYE”

- Application range is as follows.

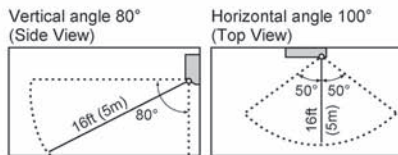

- Sensor may not detect moving objects further than 16ft (5m) away. (Check the application range)
- Sensor detection sensitivity changes according to indoor unit location, the speed of passersby, temperature range, etc.
- The sensor also mistakenly detects pets, sunlight, fluttering curtains and light reflected off of mirrors as passersby.
- INTELLIGENT EYE operation will not go on during powerful operation.
- NIGHT SET MODE [▶Page 19](#) will not go on during use of INTELLIGENT EYE operation.

⚠ CAUTION

- Do not place large objects near the sensor.
Also keep heating units or humidifiers outside the sensor's detection area. This sensor can detect undesirable objects.
- Do not hit or violently push the INTELLIGENT EYE sensor. This can lead to damage and malfunction.

POWERFUL Operation

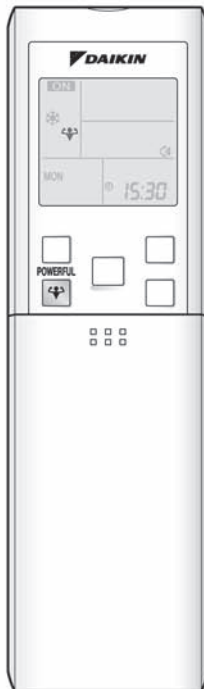

POWERFUL operation quickly maximizes the cooling (heating) effect in any operation mode. You can get the maximum capacity.

■ To start POWERFUL operation

Press  during operation.

- POWERFUL operation ends in 20 minutes. Then the system automatically operates again with the previous settings which were used before POWERFUL operation.
- “” is displayed on the LCD.
- When using POWERFUL operation, there are some functions which are not available.

■ To cancel POWERFUL operation

Press  again.

- “” disappears from the LCD.

NOTE

■ Notes on POWERFUL operation

- POWERFUL Operation cannot be used together with QUIET Operation. Priority is given to the function of whichever button is pressed last.
- POWERFUL Operation can only be set when the unit is running. Pressing the operation stop button causes the settings to be canceled, and the “” disappears from the LCD.
- **In COOL and HEAT mode**
To maximize the cooling (heating) effect, the capacity of outdoor unit must be increased and the airflow rate be fixed to the maximum setting. The temperature and airflow settings are not variable.
- **In DRY mode**
The temperature setting is lowered by 4.5°F (2.5°C) and the airflow rate is slightly increased.
- **In FAN mode**
The airflow rate is fixed to the maximum setting.
- **In AUTO mode**
To maximize the cooling (heating) effect, the capacity of outdoor unit must be increased and the airflow rate be fixed to the maximum setting.
- POWERFUL Operation will not increase the capacity of the air conditioner if the air conditioner is already in operation with its maximum capacity demonstrated.

OUTDOOR UNIT QUIET Operation

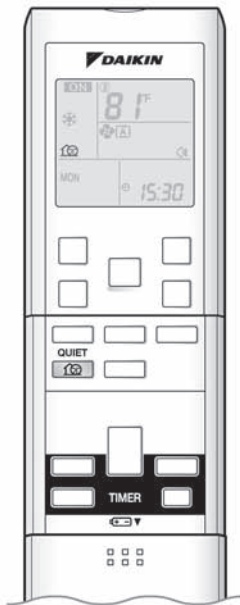

OUTDOOR UNIT QUIET operation lowers the noise level of the outdoor unit by changing the frequency and fan speed on the outdoor unit. This function is convenient during night.

■ To start OUTDOOR UNIT QUIET operation

Press .

- "🏠" is displayed on the LCD.

■ To cancel OUTDOOR UNIT QUIET operation

Press  again.

- "🏠" disappears from the LCD.

NOTE

■ Note on OUTDOOR UNIT QUIET operation

- This function is available in COOL, HEAT, and AUTO modes.
(This is not available in FAN and DRY mode.)
- POWERFUL operation and OUTDOOR UNIT QUIET operation cannot be used at the same time.
Priority is given to the function of whichever button is pressed last.
- If operation is stopped using the remote controller or the main unit ON/OFF switch when using OUTDOOR UNIT QUIET operation, "🏠" will remain on the remote controller display.
- OUTDOOR UNIT QUIET Operation will drop neither the frequency nor fan speed if the frequency and fan speed have been already dropped low enough.

HOME LEAVE Operation

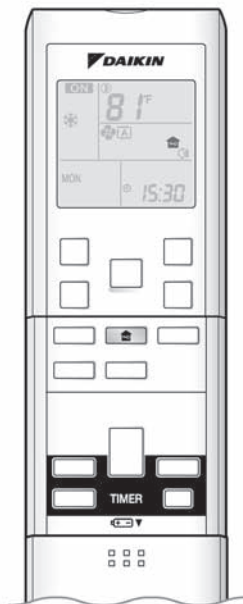

HOME LEAVE operation is a function which allows you to record your preferred temperature and airflow rate settings.

■ To start HOME LEAVE operation

1. Press .

- “” is displayed on the LCD.
- The HOME LEAVE lamp lights up.



■ To cancel HOME LEAVE operation





2. Press again.





- “” disappears from the LCD.
- The HOME LEAVE lamp goes off.

Before using HOME LEAVE operation.

■ To set the temperature and airflow rate for HOME LEAVE operation

When using HOME LEAVE operation for the first time, please set the temperature and airflow rate for HOME LEAVE operation. Record your preferred temperature and airflow rate.

	Initial setting		Selectable range	
	Temperature	Airflow rate	Temperature	Airflow rate
COOL	77°F(25°C)	AUTO	64-90°F(18-32°C)	5 step, “  ” and “  ”
HEAT	77°F(25°C)	AUTO	50-86°F(10-30°C)	5 step, “  ” and “  ”

1. Press “”. Make sure “” is displayed in the remote controller display.
2. Adjust the set temperature with “” or “” as you like.
3. Adjust the airflow rate with “FAN” setting button as you like.

Home leave operation will run with these settings the next time you use the unit. To change the recorded information, repeat steps 1 – 3.

■ What's the HOME LEAVE operation?

Is there a set temperature and airflow rate which is most comfortable, a set temperature and airflow rate which you use the most? HOME LEAVE operation is a function that allows you to record your favorite set temperature and airflow rate. You can start your favorite operation mode simply by pressing the HOME LEAVE button on the remote controller. This function is convenient in the following situations.

■ Useful in these cases

1. Use as an energy-saving mode.

Set the temperature 3-5°F(2-3°C) higher (COOL) or lower (HEAT) than normal. Setting the fan speed to the lowest setting allows the unit to be used in energy-saving mode. Also convenient for use while you are out or sleeping.

• Every day before you leave the house...



When you go out, push the "HOME LEAVE Operation" button, and the air conditioner will adjust capacity to reach the preset temperature for HOME LEAVE Operation.



When you return, you will be welcomed by a comfortably air conditioned room.



Push the "HOME LEAVE Operation" button again, and the air conditioner will adjust capacity to the set temperature for normal operation.

• Before bed...



Set the unit to HOME LEAVE Operation before leaving the living room when going to bed.



The unit will maintain the temperature in the room at a comfortable level while you sleep.



When you enter the living room in the morning, the temperature will be just right. Disengaging HOME LEAVE Operation will return the temperature to that set for normal operation. Even the coldest winters will pose no problem!

2. Use as a favorite mode.

Once you record the temperature and airflow rate settings you most often use, you can retrieve them by pressing HOME LEAVE button. You do not have to go through troublesome remote controller operations.

NOTE

- Once the temperature and airflow rate for HOME LEAVE operation are set, those settings will be used whenever HOME LEAVE operation is used in the future. To change these settings, please refer to the "Before using HOME LEAVE operation" section above.
- HOME LEAVE operation is only available in COOL and HEAT mode. It cannot be used in AUTO, DRY, and FAN mode.
- HOME LEAVE operation runs in accordance with the previous operation mode (COOL or HEAT) before using HOME LEAVE operation.
- HOME LEAVE operation and POWERFUL operation cannot be used at the same time. Last button that was pressed has priority.
- The operation mode cannot be changed while HOME LEAVE operation is being used.
- When operation is shut off during HOME LEAVE operation, using the remote controller or the indoor unit ON/OFF switch, "  " will remain on the remote controller display.

TIMER Operation

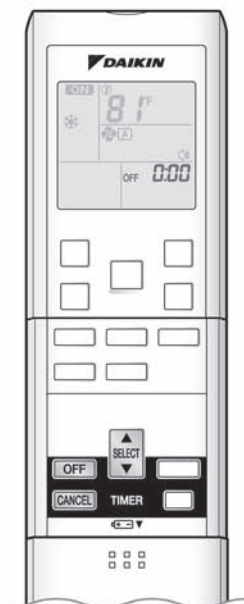

Timer functions are useful for automatically switching the air conditioner on or off at night or in the morning. You can also use OFF TIMER and ON TIMER in combination.

■ To use OFF TIMER operation

- Check that the clock is correct.
If not, set the clock to the present time. ▶Page 9

1. Press **OFF**.



2. Press **SELECT** until the time setting reaches the point you like.

- Every pressing of either button increases or decreases the time setting by 10 minutes. Holding down either button changes the setting rapidly.

3. Press **OFF** again.

- The TIMER lamp lights up.

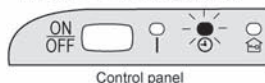

Control panel

■ To cancel OFF TIMER Operation

Press **CANCEL**.

- The TIMER lamp goes off.

NOTE

- When TIMER is set, the present time is not displayed.
- Once you set ON, OFF TIMER, the time setting is kept in the memory. (The memory is canceled when remote controller batteries are replaced.)
- When operating the unit via the ON/OFF Timer, the actual length of operation may vary from the time entered by the user. (Maximum approx. 10 minutes)

■ NIGHT SET MODE

- When the OFF TIMER is set, the air conditioner automatically adjusts the temperature setting (0.9°F(0.5°C) up in COOL, 3.6°F(2.0°C) down in HEAT) to prevent excessive COOL (HEAT) for your pleasant sleep.

TIMER Operation

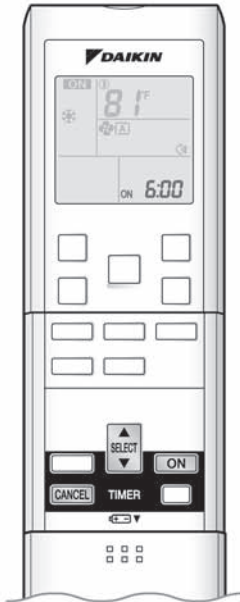

■ To use ON TIMER operation

- Check that the clock is correct.
If not, set the clock to the present time. ▶Page 9

1. Press **ON**.



2. Press **SELECT** until the time setting reaches the point you like.

- Every pressing of either button increases or decreases the time setting by 10 minutes. Holding down either button changes the setting rapidly.

3. Press **ON** again.

- The TIMER lamp lights up.



■ To cancel OFF TIMER Operation

Press **CANCEL**.

- The TIMER lamp goes off.

■ To combine ON TIMER and OFF TIMER

- A sample setting for combining the two timers is shown below.

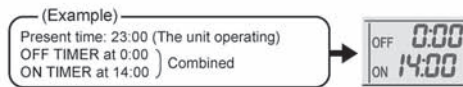

ATTENTION

■ In the following cases, set the timer again.

- After a breaker has turned OFF.
- After a power failure.
- After replacing batteries in the remote controller.

Care and Cleaning

CAUTION Before cleaning, be sure to stop the operation and turn the breaker OFF.

Units

■ Indoor unit, Outdoor unit and Remote controller

Wipe them with dry soft cloth.

Front panel

1. Open the front panel.

- Hold the panel by the tabs on the two sides and lift it until it stops with a click.

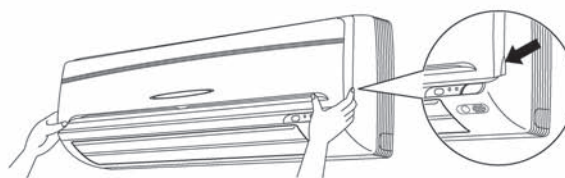

2. Remove the front panel.

- Supporting the front panel with one hand, release the lock by sliding down the knob with the other hand.
- To remove the front panel, pull it toward yourself with both hands.

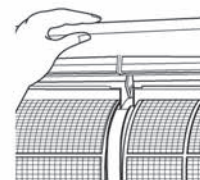

3. Clean the front panel.

- Wipe it with a soft cloth soaked in water.
- Only neutral detergent may be used.
- In case of washing the panel with water, wipe it with dry soft cloth, dry it in the shade.

4. Attach the front panel.

- Set the 3 keys of the front panel into the slots and push them in all the way.
- Close the front panel slowly and push the panel at the 3 points. (1 on each side and 1 in the middle.)
- Check to see if the rotating axis in the upper center section is moving.



CAUTION

- Do not touch the metal parts of the indoor unit. If you touch those parts, this may cause an injury.
- When removing or attaching the front panel, use a robust and stable stool and watch your steps carefully.
- When removing or attaching the front panel, support the panel securely with your hand to prevent it from falling.
- For cleaning, do not use hot water above 104°F(40°C), benzine, gasoline, thinner, nor other volatile oils, polishing compound, scrubbing brushes, nor other hand stuff.
- After cleaning, make sure that the front panel is securely fixed.

Care and Cleaning

Filters

1. Open the front panel. ▶Page 21

2. Pull out the air filters.

- Push a little upwards the tab at the center of each air filter, then pull it down.



3. Take off the Air-purifying filter with photocatalytic deodorizing function.

- Hold the recessed parts of the frame and unhook the four claws.

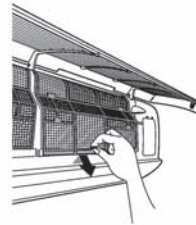

Air-purifying filter with photocatalytic deodorizing function

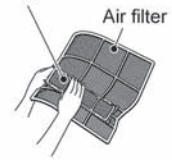

4. Clean or replace each filter.

See figure.

5. Set the air filter and the Air-purifying filter with photocatalytic deodorizing function as they were and close the front panel.

- Insert claws of the filters into slots of the front panel.
Close the front panel slowly and push the panel at the 3 points.
(1 on each side and 1 in the middle.)

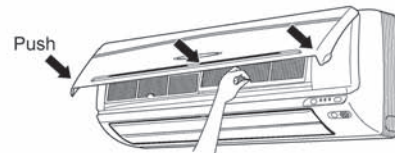

CAUTION

- Do not touch the aluminum fins by bare hand at the time of dismounting or mounting the filter.

Air Filter**Wash the air filters with water or clean them with vacuum cleaner.**

- If the dust does not come off easily, wash them with neutral detergent thinned with lukewarm water, then dry them up in the shade.
- It is recommended to clean the air filters every 2 weeks.

**Air-purifying filter with photocatalytic deodorizing function**

The Air-purifying filter with photocatalytic deodorizing function can be renewed by washing it with water once every 6 months. We recommend replacing it once every 3 years.

[Maintenance]

- 1. Vacuum dust, and soak in warm water or water for about 10 to 15 minutes if dirt is heavy.**
- 2. Do not remove filter from frame when washing with water.**
- 3. After washing, shake off remaining water and dry in the shade.**
- 4. Since the material is made out of paper, do not wring out the filter when removing water from it.**

[Replacement]

- 1. Remove the tabs on the filter frame and replace with a new filter.**

- Dispose of the old filter as flammable waste.

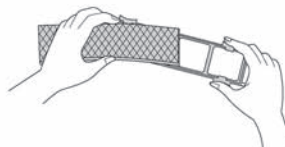

Care and Cleaning

NOTE

- Operation with dirty filters:
 - 1) cannot deodorize the air.
 - 2) cannot clean the air.
 - 3) results in poor Heating or Cooling.
 - 4) may cause odor
- To order Air-purifying filter with photocatalytic deodorizing function, contact the service shop where you bought the air conditioner.
- Dispose of old filters as flammable waste.

Item	Part No.
Air-purifying filter with photocatalytic deodorizing function (with frame) 1 set	KAF918A43
Air-purifying filter with photocatalytic deodorizing function (without frame) 1 set	KAF918A44

ATTENTION



- Do not throw away the filter frame. Reuse the filter frame when replacing the Air-purifying filter with photocatalytic deodorizing function.

CHECK

- Check that the base, stand and other fittings of the outdoor unit are not decayed or corroded.
- Check that nothing blocks the air inlets and the outlets of the indoor unit and the outdoor unit.
- Check that the drain comes smoothly out of the drain hose during COOL or DRY operation.
 - If no drain water is seen, water may be leaking from the indoor unit. Stop operation and consult the service shop if this is the case.

Before a long idle period

1. Operate the “FAN only” for several hours on a fine day to dry out the inside.

- Press **MODE** and select “” operation.
- Press  and start operation.

2. After operation stops, turn off the breaker for the room air conditioner.

3. Clean the air filters and set them again.

4. Take out batteries from the remote controller.

Trouble Shooting

These cases are not troubles.

The following cases are not air conditioner troubles but have some reasons. You may just continue using it.

Case	Explanation
Operation does not start soon. <ul style="list-style-type: none"> When ON/OFF button was pressed soon after operation was stopped. When the mode was reselected. 	<ul style="list-style-type: none"> This is to protect the air conditioner. You should wait for about 3 minutes.
Hot air does not flow out soon after the start of heating operation.	<ul style="list-style-type: none"> The air conditioner is warming up. You should wait for 1 to 4 minutes. (The system is designed to start discharging air only after it has reached a certain temperature.)
The heating operation stops suddenly and a flowing sound is heard.	<ul style="list-style-type: none"> The system is taking away the frost on the outdoor unit. You should wait for about 4 to 12 minutes.
The outdoor unit emits water or steam.	<ul style="list-style-type: none"> In HEAT mode <ul style="list-style-type: none"> The frost on the outdoor unit melts into water or steam when the air conditioner is in defrost operation. In COOL or DRY mode <ul style="list-style-type: none"> Moisture in the air condenses into water on the cool surface of outdoor unit piping and drips.
Mist comes out of the indoor unit.	<ul style="list-style-type: none"> This happens when the air in the room is cooled into mist by the cold airflow during cooling operation. This is because the air in the room is cooled by the heat exchanger and becomes mist during defrost operation.
The indoor unit gives out odour.	<ul style="list-style-type: none"> This happens when smells of the room, furniture, or cigarettes are absorbed into the unit and discharged with the airflow. (If this happens, we recommend you to have the indoor unit washed by a technician. Consult the service shop where you bought the air conditioner.)
The outdoor fan rotates while the air conditioner is not in operation.	<ul style="list-style-type: none"> After operation is stopped: <ul style="list-style-type: none"> The outdoor fan continues rotating for another 60 seconds for system protection. While the air conditioner is not in operation: <ul style="list-style-type: none"> When the outdoor temperature is very high, the outdoor fan starts rotating for system protection.
The operation stopped suddenly. (OPERATION lamp is on.)	<ul style="list-style-type: none"> For system protection, the air conditioner may stop operating on a sudden large voltage fluctuation. It automatically resumes operation in about 3 minutes.
No remote controller signals are displayed. The remote controller sensitivity is low. The display is low in contrast or blacked out. The display runs out of control.	<ul style="list-style-type: none"> The batteries are dying and the remote controller is malfunctioning. Replace all the batteries with new size batteries, AAA.LR03 (alkaline). For details, refer to "To set the batteries" of this manual. ▶Page 8

Trouble Shooting

Check again.

Please check again before calling a repair person.

Case	Check
<p>The air conditioner does not operate. (OPERATION lamp is off.)</p>	<ul style="list-style-type: none"> • Hasn't a breaker turned OFF or a fuse blown? • Isn't it a power failure? • Are batteries set in the remote controller? • Is the timer setting correct?
<p>Cooling (Heating) effect is poor.</p>	<ul style="list-style-type: none"> • Are the air filters clean? • Is there anything to block the air inlet or the outlet of the indoor and the outdoor units? • Is the temperature setting appropriate? • Are the windows and doors closed? • Are the airflow rate and the air direction set appropriately?
<p>Operation stops suddenly. (OPERATION lamp flashes.)</p>	<ul style="list-style-type: none"> • Are the air filters clean? • Is there anything to block the air inlet or the outlet of the indoor and the outdoor units? Clean the air filters or take all obstacles away and turn the breaker OFF. Then turn it ON again and try operating the air conditioner with the remote controller. If the lamp still flashes, call the service shop where you bought the air conditioner.
<p>An abnormal functioning happens during operation.</p>	<ul style="list-style-type: none"> • The air conditioner may malfunction with lightning or radio waves. Turn the breaker OFF, turn it ON again and try operating the air conditioner with the remote controller.
<p>The fin does not start swinging immediately.</p>	<ul style="list-style-type: none"> • The air conditioner is adjusting the fin position. The fin will start moving soon.

■ **Call the service shop immediately.**

 **WARNING**

- **When an abnormality (such as a burning smell) occurs, stop operation and turn the breaker OFF.**
Continued operation in an abnormal condition may result in problems, electric shocks or fire.
Consult the service shop where you bought the air conditioner.
- **Do not attempt to repair or modify the air conditioner by yourself.**
Incorrect work may result in electric shocks or fire.
Consult the service shop where you bought the air conditioner.

If one of the following symptoms takes place, call the service shop immediately.

- The power cord is abnormally hot or damaged.
- An abnormal sound is heard during operation.
- The safety breaker, a fuse, or the ground leakage breaker cuts off the operation frequently.
- A switch or a button often fails to work properly.
- There is a burning smell.
- Water leaks from the indoor unit.

Turn the breaker OFF and call the service shop.



■ **After a power failure**

The air conditioner automatically resumes operation in about 3 minutes. You should just wait for a while.

■ **Lightning**

If lightning may strike the neighboring area, stop operation and turn the breaker OFF for system protection.

■ **We recommend periodical maintenance.**

In certain operating conditions, the inside of the air conditioner may get foul after several seasons of use, resulting in poor performance. It is recommended to have periodical maintenance by a specialist aside from regular cleaning by the user. For specialist maintenance, contact the service shop where you bought the air conditioner. The maintenance cost must be born by the user.

Fault diagnosis.

FAULT DIAGNOSIS BY REMOTE CONTROLLER

In the ARC452A series, the temperature display sections on the main unit indicate corresponding codes.

1. When the **TIMER CANCEL** button is held down for 5 seconds, a "00" indication flashes on the temperature display section.

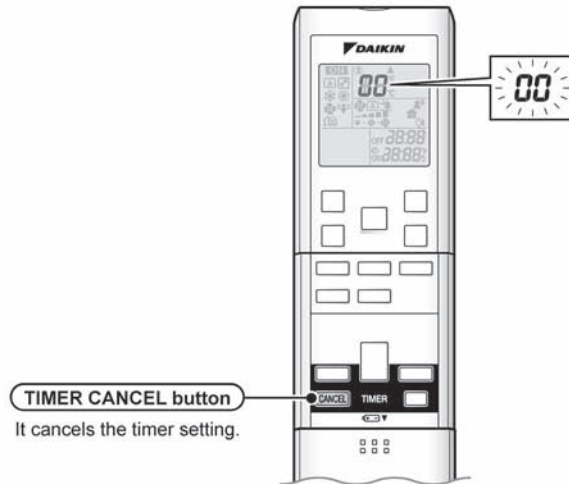

2. Press the **TIMER CANCEL** button repeatedly until a continuous beep is produced.

• The code indication changes as shown below, and notifies with a long beep.

	CODE	MEANING
SYSTEM	00	NORMAL
	U0	REFRIGERANT SHORTAGE
	U2	DROP VOLTAGE OR MAIN CIRCUIT OVERVOLTAGE
	U4	FAILURE OF TRANSMISSION (BETWEEN INDOOR UNIT AND OUTDOOR UNIT)
INDOOR UNIT	A1	INDOOR PCB DEFECTIVENESS
	A5	HIGH PRESSURE CONTROL OR FREEZE-UP PROTECTOR
	A6	FAN MOTOR FAULT
	C4	FAULTY HEAT EXCHANGER TEMPERATURE SENSOR
OUTDOOR UNIT	C9	FAULTY SUCTION AIR TEMPERATURE SENSOR
	EA	COOLING-HEATING SWITCHING ERROR
	E5	OL STARTED
	E6	FAULTY COMPRESSOR START UP
	E7	DC FAN MOTOR FAULT
	E8	OPERATION HALT DUE TO DETECTION OF INPUT OVER CURRENT
	F3	HIGH TEMPERATURE DISCHARGE PIPE CONTROL
	F6	HIGH PRESSURE CONTROL (IN COOLING)
	H6	OPERATION HALT DUE TO FAULTY POSITION DETECTION SENSOR
	H8	CT ABNORMALITY
	H9	FAULTY SUCTION AIR TEMPERATURE SENSOR
	J3	FAULTY DISCHARGE PIPE TEMPERATURE SENSOR
	J6	FAULTY HEAT EXCHANGER TEMPERATURE SENSOR
	L4	HIGH TEMPERATURE AT INVERTER CIRCUIT HEATSINK
L5	OUTPUT OVERCURRENT	
P4	FAULTY INVERTER CIRCUIT HEATSINK TEMPERATURE SENSOR	

NOTE

1. A short beep and two consecutive beeps indicate non-corresponding codes.
2. To cancel the code display, hold the **TIMER CANCEL** button down for 5 seconds. The code display also cancel itself if the button is not pressed for 1 minute.

12.3 15/18/24 Class

Name of Parts

Indoor Unit

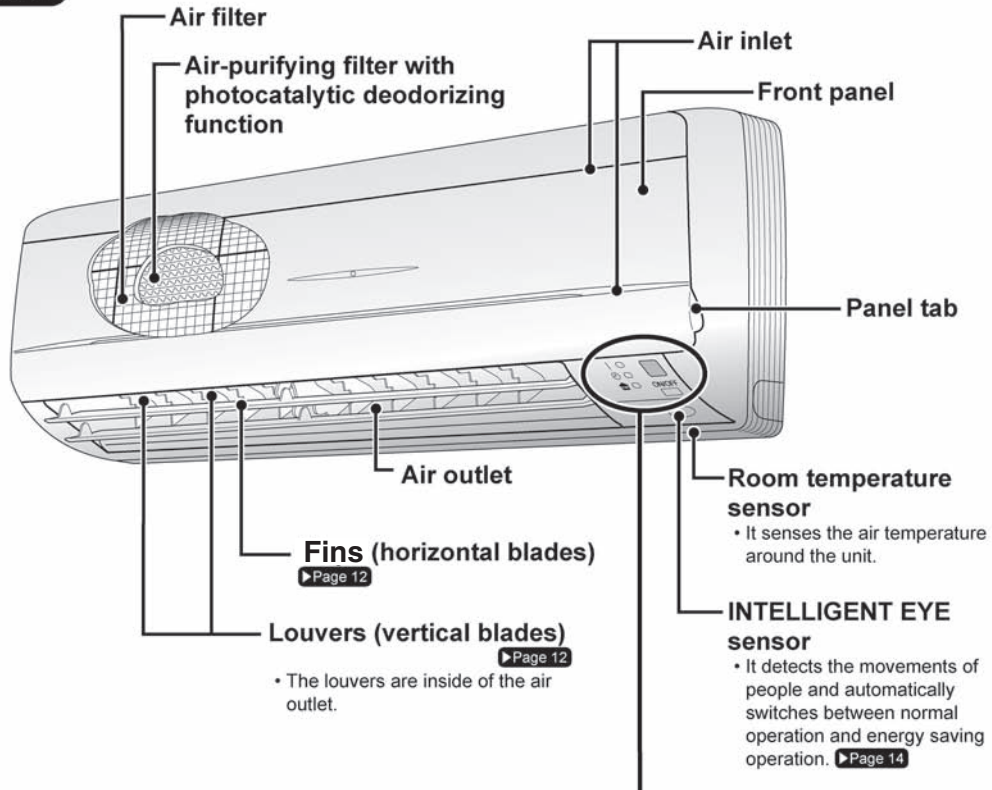

Control panel

Operation lamp (green)

TIMER lamp (yellow)
▶Page 20

HOME LEAVE lamp (red)
▶Page 18

- Lights up when you use HOME LEAVE Operation.

Signal receiver

- It receives signals from the remote controller.
- When the unit receives a signal, you will hear a short beep.
- Operation start beep-beep
- Settings changed beep
- Operation stop beeeeeeep

Indoor unit ON/OFF switch

- Push this switch once to start operation. Push once again to stop it.
- For operation mode, refer to the following table.

Mode	Temperature setting	Airflow rate
AUTO	77°F(25°C)	AUTO

- This switch is useful when the remote controller is missing.

Open the front panel

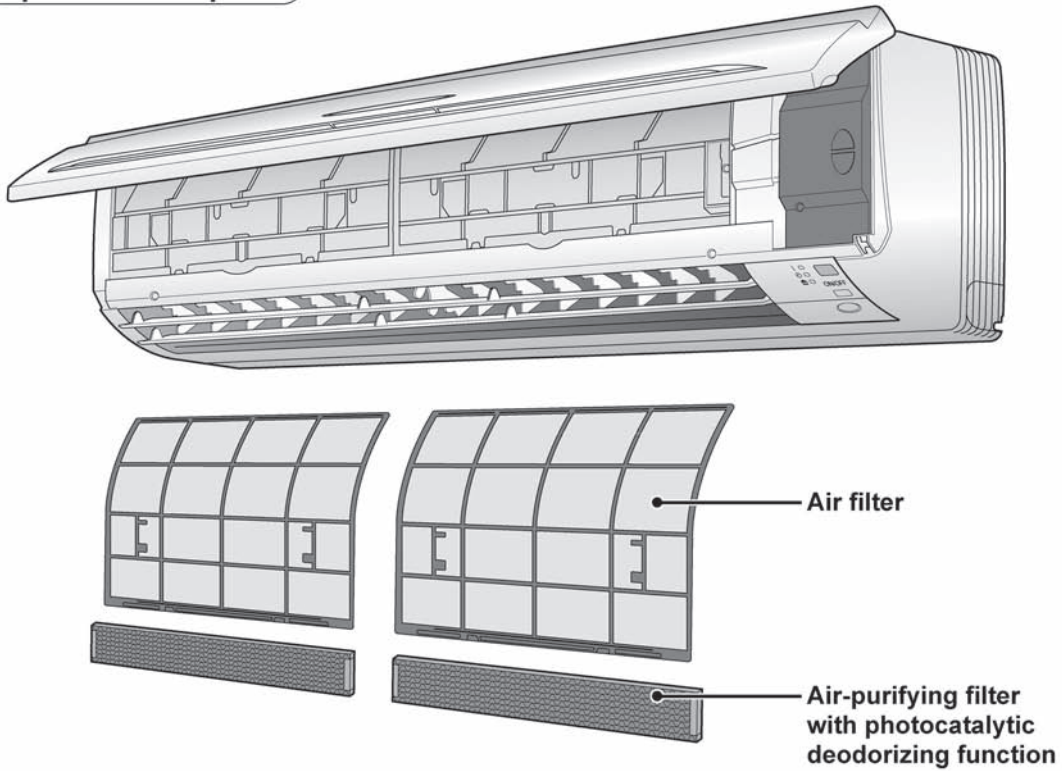

Outdoor Unit

• Appearance of the outdoor unit may differ from some models.

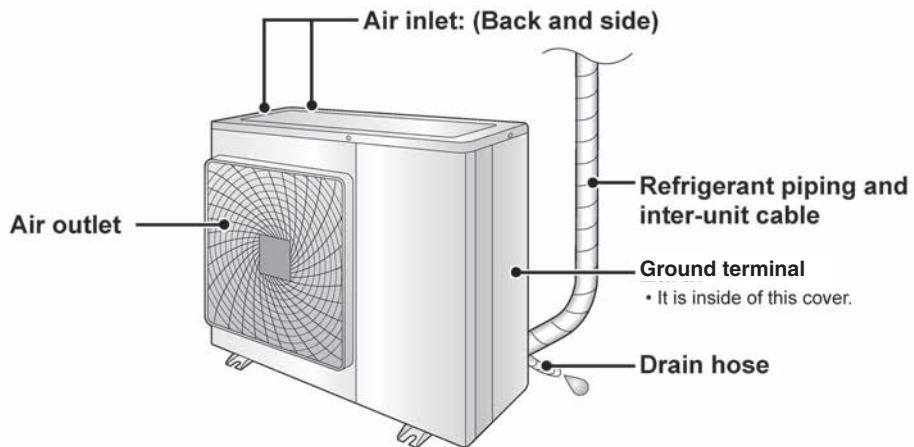

Name of Parts

Remote Controller: ARC452A9

Signal transmitter

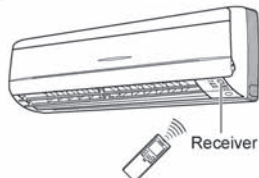

- To use the remote controller, aim the transmitter at the indoor unit. If there is anything to block signals between the unit and the remote controller, such as a curtain, the unit will not operate.
- Do not drop the remote controller. Do not get it wet.
- The maximum distance for communication is approximately 23 ft (7m).

FAN setting button

- It selects the airflow rate setting.

▶Page 11

POWERFUL button

- POWERFUL operation ▶Page 16

Display (LCD)

- It displays the current settings. (In this illustration, each section is shown with its displays ON for the purpose of explanation.)

TEMPERATURE adjustment buttons

- It changes the temperature setting.

▶Page 10

ON/OFF button

- Press this button once to start operation.

Press once again to stop it. ▶Page 10

Front cover

- Open the front cover. ▶Page 7

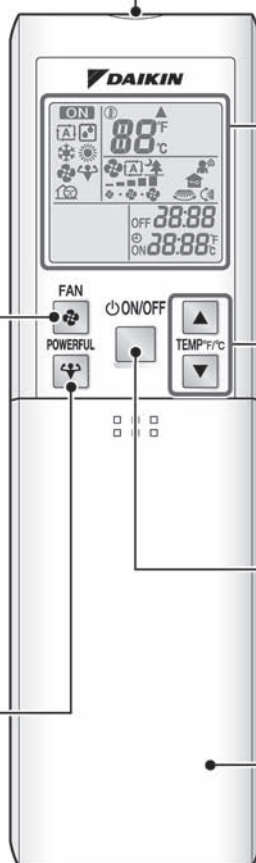

Open the front cover

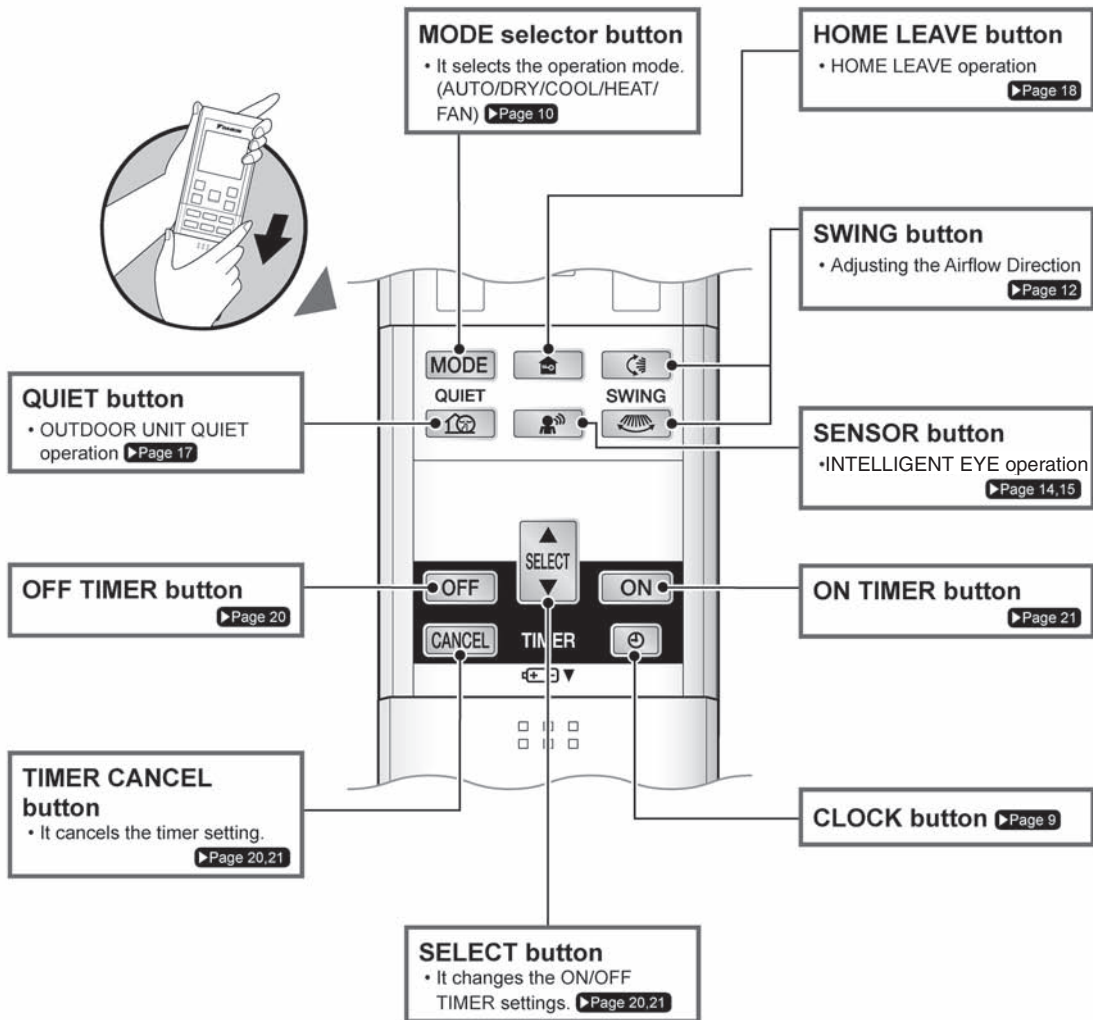

Preparation before Operation

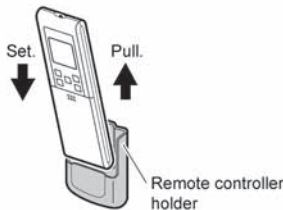
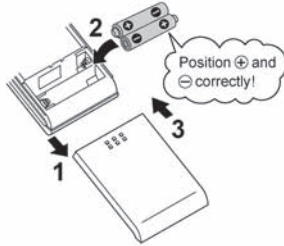

■ To set the batteries

1. Slide the front cover to take it off.
2. Set 2 dry batteries AAA.LR03 (alkaline).
3. Set the front cover as before.

■ To fix the remote controller holder on the wall

1. Choose a place from where the signals reach the unit.
2. Fix the holder to a wall, a pillar, etc. with the screws supplied with the holder.
3. Place the remote controller in the remote controller holder.

■ Celsius/Fahrenheit display switch

- The Celsius or Fahrenheit display is selectable with the following buttons.

Press  and  buttons simultaneously for 5 seconds.

- The temperature will be displayed in Fahrenheit if it is presently displayed in Celsius, and vice versa.

ATTENTION

■ About batteries

- When replacing the batteries, use batteries of the same type, and replace the 2 old batteries together.
- When the system is not used for a long time, take the batteries out.
- The batteries will last for approximately 1 year. If the remote controller display begins to fade and the degradation of reception performance occurs within a year, however, replace both 2 batteries with new, size AAA.LR03 (alkaline).
- The attached batteries are provided for the initial use of the system.
The usable period of the batteries may be short depending on the manufactured date of the air conditioner.

■ About remote controller

- Never expose the remote controller to direct sunlight.
- Dust on the signal transmitter or receiver will reduce the sensitivity. Wipe off dust with soft cloth.
- Signal communication may be disabled if an electronic-starter-type fluorescent lamp (such as inverter-type lamps) is in the room. Consult the shop if that is the case.
- If the remote controller signals happen to operate another appliance, move that appliance to somewhere else, or consult the service shop.

■ Celsius/Fahrenheit display change function of remote controller

- The set temperature may increase when the display is changed to Celsius from Fahrenheit, because a fraction of 0.5°C is rounded up.
- Example: A set temperature of 64°F (equivalent to 18.5°C) will be converted into 19°C.
When the display is changed to Fahrenheit again, the set temperature will be converted into 66°F (equivalent to 19°C) instead of the original set temperature (64°F) but a set temperature of 66°F (equivalent to 19°C) will be converted into 19°C with no temperature change.
- A reception sound will go off for the transmission of set temperature to the indoor unit at the time of setting the Celsius/Fahrenheit display change function.

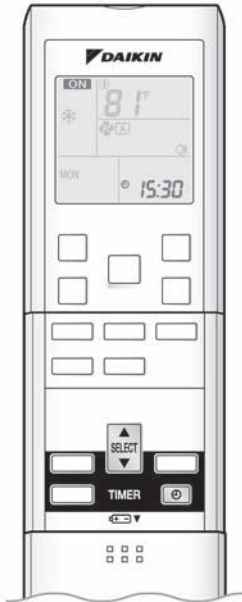

■ Turn the breaker ON

- Turning ON the breaker closes the flap. (This is a normal procedure.)

■ To set the clock

1. Press



"0:00" is displayed.
"MON" and "⏻" blinks.

2. Press to set the current day of the week.

3. Press .



"⏻" blinks.

4. Press to set the clock to the present time.

- Holding down button rapidly increases or decreases the time display.

5. Press .

- Always point the remote controller at the indoor unit when pushing the buttons when setting the indoor unit's internal clock.



"." blinks.

NOTE

■ Tips for saving energy

- Be careful not to COOL (HEAT) the room too much.
Keeping the temperature setting at a moderate level helps save energy.
- Cover windows with a blind or a curtain.
Blocking sunlight and air from outdoors increases the cooling (heating) effect.
- Clogged air filters cause inefficient operation and waste energy. Clean them once in about every two weeks.

Recommended temperature setting
For COOL: 78°F – 82°F (26°C – 28°C)
For HEAT: 68°F – 75°F (20°C – 24°C)

■ Please note

- The air conditioner always consumes 50-120 btu/h (15-35 watts) of electricity even while it is not operating.
- If you are not going to use the air conditioner for a long period, for example in spring or autumn, turn the breaker OFF.
- Use the air conditioner in the following conditions.

Mode	Operating conditions	If operation is continued out of this range
COOL	Outdoor temperature : 14 to 115°F (-10 to 46°C) Indoor temperature : 64 to 90°F (18 to 32°C) Indoor humidity : 80% max.	<ul style="list-style-type: none"> • A safety device may work to stop the operation. • See Note 2 for 0°F to 14°F operation. • Condensation may occur on the indoor unit and drip.
HEAT	Outdoor temperature : 5 to 64°F (-15 to 18°C) Indoor temperature : 50 to 86°F (10 to 30°C)	<ul style="list-style-type: none"> • A safety device may work to stop the operation. Under 0°F or over 64°F outdoor temperature. • See the Note 3 for 0°F to 5°F.
DRY	Outdoor temperature : 14 to 115°F (-10 to 46°C) Indoor temperature : 64 to 90°F (18 to 32°C) Indoor humidity : 80% max.	<ul style="list-style-type: none"> • A safety device may work to stop the operation. • Condensation may occur on the indoor unit and drip.

- Operation outside this humidity or temperature range may cause a safety device to disable the system.

AUTO · DRY · COOL · HEAT · FAN Operation

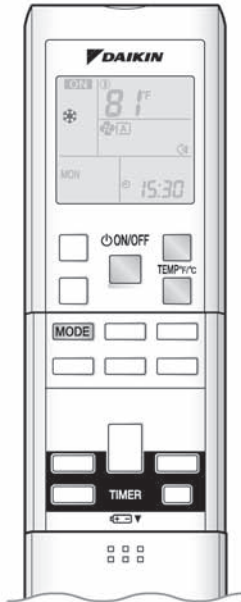

The air conditioner operates with the operation mode of your choice.
From the next time on, the air conditioner will operate with the same operation mode.

■ To start operation

1. Press **MODE** and select a operation mode.

- Each pressing of the button advances the mode setting in sequence.

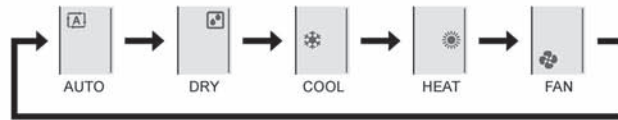

2. Press .

- "ON" is displayed on the LCD.
- The OPERATION lamp lights up.



Control panel

■ To stop operation

Press  again.

- "ON" is displayed on the LCD.
- Then OPERATION lamp goes off.

■ To change the temperature setting

Press  or .

- The displayed items on the LCD will change whenever either one of the buttons is pressed.

	DRY or FAN mode	COOL mode	HEAT mode	AUTO mode
The temperature setting is not variable.		64~90°F (18~32°C)	50~86°F (10~30°C)	64~86°F (18~30°C)
		Press ▲ to raise the temperature and press ▼ to lower the temperature.		

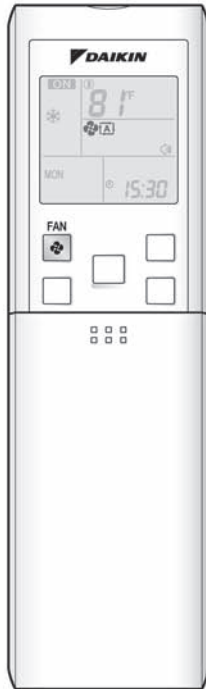

■ To change the airflow rate setting

Press .

DRY mode	AUTO or COOL or HEAT or FAN mode
The airflow rate setting is not variable.	Five levels of airflow rate setting from " " to " " plus "[A]" and " " are available. 

- Indoor unit quiet operation
When the airflow is set to " ", the noise from the indoor unit will become quieter. Use this when making the noise quieter. The unit might lose capacity when the airflow rate is set to a weak level.
- Each pressing of the button advances the airflow rate setting in sequence.



NOTE

■ Note on HEAT operation

- Since this air conditioner heats the room by taking heat from outdoor air to indoors, the heating capacity becomes smaller in lower outdoor temperatures. If the heating effect is insufficient, it is recommended to use another heating appliance in combination with the air conditioner.
- The heat pump system heats the room by circulating hot air around all parts of the room. After the start of HEAT operation, it takes some time before the room gets warmer.
- In HEAT operation, frost may occur on the outdoor unit and lower the heating capacity. In that case, the system switches into defrosting operation to take away the frost.
- During defrosting operation, hot air does not flow out of indoor unit.

■ Note on COOL operation

- This air conditioner cools the room by blowing the hot air in the room outside, so if the outside temperature is high, the performance of the air conditioner drops.

■ Note on DRY operation

- The computer chip works to rid the room of humidity while maintaining the temperature as much as possible. It automatically controls temperature and airflow rate, so manual adjustment of these functions is unavailable.

■ Note on AUTO operation

- In AUTO operation, the system selects a temperature setting and an appropriate operation mode (COOL or HEAT) based on the room temperature at the start of the operation.
- The system automatically reselects setting at a regular interval to bring the room temperature to user-setting level.
- If you do not like AUTO operation, manually change the set temperature.

■ Note on FAN operation

- This is valid for fan only.

■ Note on airflow rate setting

- At smaller airflow rates, the cooling (heating) effect is also smaller.

Adjusting the Airflow Direction



You can adjust the airflow direction to increase your comfort.

Adjusting the upper and lower airflow direction

■ To adjust the fins (horizontal blades)

1. Press .

- "🌀" is displayed on the LCD and the fins will begin to swing.

2. When the fins have reached the desired position, press  once more.

- The fins will stop moving.
- "🌀" disappears from the LCD.

Adjusting the right and left airflow direction

■ To adjust the louvers (vertical blades)





3. Press .

- "🌀" is displayed on the LCD.

4. When the louvers have reached the desired position, press the  once more.

- The louvers will stop moving.
- "🌀" disappears from the LCD.

■ To start 3-D Airflow

1. 3. Press the  and the  :
the “” and “” display will light up and the fins and louvers will move in turn.

■ To cancel 3-D Airflow

2. 4. Press either the  or the .

NOTE

■ Notes on fins and louvers angles

- When “SWING button” is selected, the fins swinging range depends on the operation mode. (See the figure.)

Three-Dimensional (3-D) Airflow

- Using three-dimensional airflow circulates cold air, which tends to collect at the bottom of the room, and hot air, which tends to collect near the ceiling, throughout the room, preventing areas of cold and hot developing.

■ ATTENTION

- Always use a remote controller to adjust the angles of the fins and louvers. If you attempt to move it forcibly with hand when it is swinging, the mechanism may be broken.
- Always use a remote controller to adjust the louvers angles. In side the air outlet, a fan is rotating at a high speed.

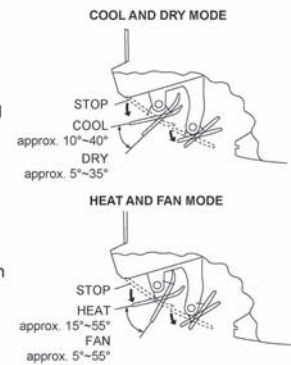

INTELLIGENT EYE Operation

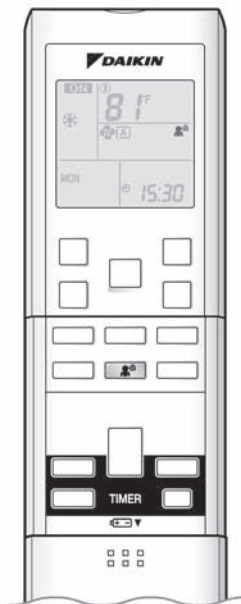

"INTELLIGENT EYE" is the infrared sensor which detects the human movement.

■ To start INTELLIGENT EYE operation

1. Press .

- "" displayed on the LCD.

■ To cancel the INTELLIGENT EYE operation

2. Press  again.

- "" disappears from the LCD.

[EX.]

When somebody in the room

• Normal operation

The air conditioner is in normal operation while the sensor is detecting the movement of people.



When nobody in the room

• 20 min. after, start energy saving operation.

The set temperature is shifted in $\pm 3.6^{\circ}\text{F}$ ($\pm 2^{\circ}\text{C}$) steps.

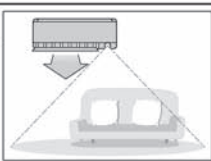

Somebody back in the room

• Back to normal operation.

The air conditioner will return to normal operation when the sensor detects the movement of people again.



“INTELLIGENT EYE” is useful for Energy Saving

■ Energy saving operation

- Change the temperature -3.6°F (-2°C) in HEAT / $+3.6^{\circ}\text{F}$ ($+2^{\circ}\text{C}$) in COOL / $+1.8^{\circ}\text{F}$ ($+1^{\circ}\text{C}$) in DRY mode from set temperature.
- Decrease the airflow rate slightly in FAN mode only.
- If no presence detected in the room for 20 minutes.

NOTE

■ Notes on “INTELLIGENT EYE”

- Application range is as follows.

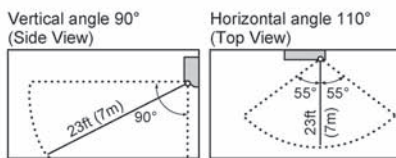

- Sensor may not detect moving objects further than 23ft (7m) away. (Check the application range)
- Sensor detection sensitivity changes according to indoor unit location, the speed of passersby, temperature range, etc.
- The sensor also mistakenly detects pets, sunlight, fluttering curtains and light reflected off of mirrors.
- INTELLIGENT EYE operation will not go on during powerful operation.
- NIGHT SET MODE (Page 20) will not go on during use of INTELLIGENT EYE operation.

- The volume of air will be set to AUTO. If the upward and downward airflow direction is selected, the COMFORT AIRFLOW operation will be canceled. Priority is given to the function of whichever button is pressed last.

CAUTION

- Do not place large objects near the sensor. Also keep heating units or humidifiers outside the sensor's detection area. This sensor can detect undesirable objects.
- Do not hit or violently push the INTELLIGENT EYE sensor. This can lead to damage and malfunction.

POWERFUL Operation

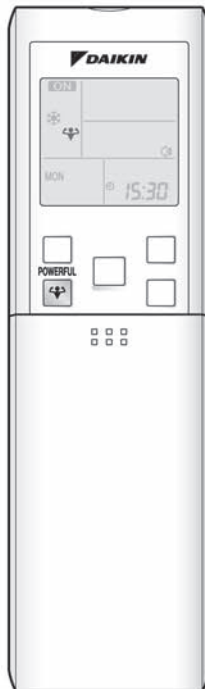

POWERFUL operation quickly maximizes the cooling (heating) effect in any operation mode. You can get the maximum capacity.

■ To start POWERFUL operation

Press  during operation.

- POWERFUL operation ends in 20 minutes. Then the system automatically operates again with the previous settings which were used before POWERFUL operation.
- “” is displayed on the LCD.
- When using POWERFUL operation, there are some functions which are not available.

■ To cancel POWERFUL operation

Press  again.

- “” disappears from the LCD.

NOTE

■ Notes on POWERFUL operation

- POWERFUL Operation cannot be used together with QUIET Operation. Priority is given to the function of whichever button is pressed last.
- POWERFUL Operation can only be set when the unit is running. Pressing the operation stop button causes the settings to be canceled, and the “” disappears from the LCD.
- **In COOL and HEAT mode**
To maximize the cooling (heating) effect, the capacity of outdoor unit must be increased and the airflow rate be fixed to the maximum setting. The temperature and airflow settings are not variable.
- **In DRY mode**
The temperature setting is lowered by 4.5°F (2.5°C) and the airflow rate is slightly increased.
- **In FAN mode**
The airflow rate is fixed to the maximum setting.
- **In AUTO mode**
To maximize the cooling (heating) effect, the capacity of outdoor unit must be increased and the airflow rate be fixed to the maximum setting.
- POWERFUL Operation will not increase the capacity of the air conditioner if the air conditioner is already in operation with its maximum capacity demonstrated.

OUTDOOR UNIT QUIET Operation

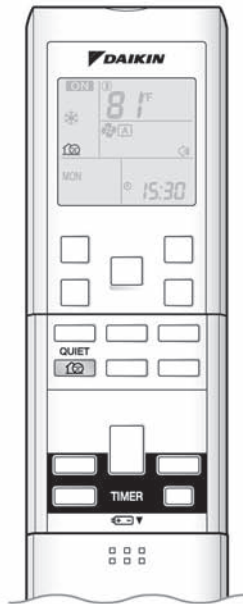

OUTDOOR UNIT QUIET operation lowers the noise level of the outdoor unit by changing the frequency and fan speed on the outdoor unit. This function is convenient during night.

■ To start OUTDOOR UNIT QUIET operation

Press .

• "" is displayed on the LCD.

■ To cancel OUTDOOR UNIT QUIET operation

Press  again.

• "" disappears from the LCD.

NOTE

■ Note on OUTDOOR UNIT QUIET operation

- This function is available in COOL, HEAT, and AUTO modes.
(This is not available in FAN and DRY mode.)
- POWERFUL operation and OUTDOOR UNIT QUIET operation cannot be used at the same time.
Priority is given to the function of whichever button is pressed last.
- If operation is stopped using the remote controller or the main unit ON/OFF switch when using OUTDOOR UNIT QUIET operation, "" will remain on the remote controller display.
- OUTDOOR UNIT QUIET Operation will drop neither the frequency nor fan speed if the frequency and fan speed have been already dropped low enough.

HOME LEAVE Operation

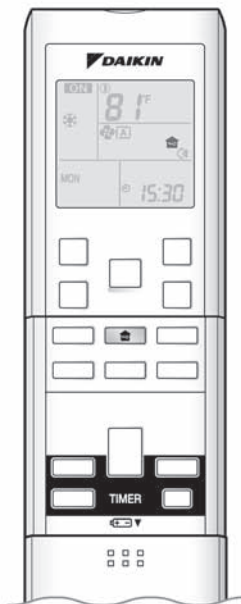

HOME LEAVE operation is a function which allows you to record your preferred temperature and airflow rate settings.

■ To start HOME LEAVE operation

1. Press .

- "  " is displayed on the LCD.
- The HOME LEAVE lamp lights up.

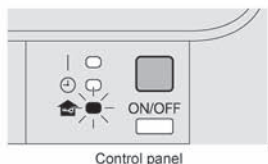

■ To cancel HOME LEAVE operation





2. Press again.





- "  " disappears from the LCD.
- The HOME LEAVE lamp goes off.

Before using HOME LEAVE operation.

■ To set the temperature and airflow rate for HOME LEAVE operation

When using HOME LEAVE operation for the first time, please set the temperature and airflow rate for HOME LEAVE operation. Record your preferred temperature and airflow rate.

	Initial setting		Selectable range	
	Temperature	Airflow rate	Temperature	Airflow rate
COOL	77°F(25°C)	AUTO	64-90°F(18-32°C)	5 step, "  " and "  "
HEAT	77°F(25°C)	AUTO	50-86°F(10-30°C)	5 step, "  " and "  "

1. Press  . Make sure "  " is displayed in the remote controller display.
2. Adjust the set temperature with "  " or "  " as you like.
3. Adjust the airflow rate with "FAN" setting button as you like.

Home leave operation will run with these settings the next time you use the unit. To change the recorded information, repeat steps 1 – 3.

■ What's the HOME LEAVE operation?

Is there a set temperature and airflow rate which is most comfortable, a set temperature and airflow rate which you use the most? HOME LEAVE operation is a function that allows you to record your favorite set temperature and airflow rate. You can start your favorite operation mode simply by pressing the HOME LEAVE button on the remote controller. This function is convenient in the following situations.

■ Useful in these cases

1. Use as an energy-saving mode.

Set the temperature 3-5°F(2-3°C) higher (COOL) or lower (HEAT) than normal. Setting the fan speed to the lowest setting allows the unit to be used in energy-saving mode. Also convenient for use while you are out or sleeping.

• Every day before you leave the house...



When you go out, push the "HOME LEAVE Operation" button, and the air conditioner will adjust capacity to reach the preset temperature for HOME LEAVE Operation.



When you return, you will be welcomed by a comfortably air conditioned room.



Push the "HOME LEAVE Operation" button again, and the air conditioner will adjust capacity to the set temperature for normal operation.

• Before bed...



Set the unit to HOME LEAVE Operation before leaving the living room when going to bed.



The unit will maintain the temperature in the room at a comfortable level while you sleep.



When you enter the living room in the morning, the temperature will be just right. Disengaging HOME LEAVE Operation will return the temperature to that set for normal operation. Even the coldest winters will pose no problem!

2. Use as a favorite mode.

Once you record the temperature and airflow rate settings you most often use, you can retrieve them by pressing HOME LEAVE button. You do not have to go through troublesome remote controller operations.

NOTE

- Once the temperature and airflow rate for HOME LEAVE operation are set, those settings will be used whenever HOME LEAVE operation is used in the future. To change these settings, please refer to the "Before using HOME LEAVE operation" section above.
- HOME LEAVE operation is only available in COOL and HEAT mode. It cannot be used in AUTO, DRY, and FAN mode.
- HOME LEAVE operation runs in accordance with the previous operation mode (COOL or HEAT) before using HOME LEAVE operation.
- HOME LEAVE operation and POWERFUL operation cannot be used at the same time. Last button that was pressed has priority.
- The operation mode cannot be changed while HOME LEAVE operation is being used.
- When operation is shut off during HOME LEAVE operation, using the remote controller or the indoor unit ON/OFF switch, "🏠" will remain on the remote controller display.

TIMER Operation

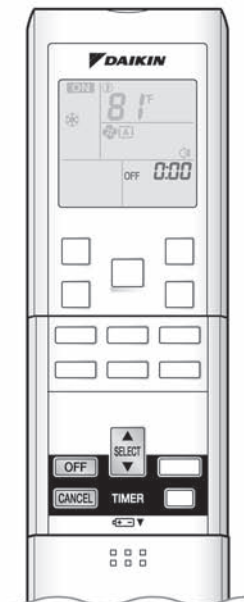

Timer functions are useful for automatically switching the air conditioner on or off at night or in the morning. You can also use OFF TIMER and ON TIMER in combination.

■ To use OFF TIMER operation

- Check that the clock is correct.
If not, set the clock to the present time. ▶Page 9

1. Press **OFF**.



2. Press **SELECT** until the time setting reaches the point you like.

- Every pressing of either button increases or decreases the time setting by 10 minutes. Holding down either button changes the setting rapidly.

3. Press **OFF** again.

- The TIMER lamp lights up.

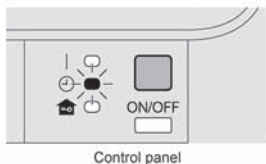

Control panel

■ To cancel OFF TIMER Operation

Press **CANCEL**.

- The TIMER lamp goes off.

NOTE

- When TIMER is set, the present time is not displayed.
- Once you set ON, OFF TIMER, the time setting is kept in the memory. (The memory is canceled when remote controller batteries are replaced.)
- When operating the unit via the ON/OFF Timer, the actual length of operation may vary from the time entered by the user. (Maximum approx. 10 minutes)

■ NIGHT SET MODE

- When the OFF TIMER is set, the air conditioner automatically adjusts the temperature setting (0.9°F(0.5°C) up in COOL, 3.6°F(2.0°C) down in HEAT) to prevent excessive cooling (heating) for your pleasant sleep.

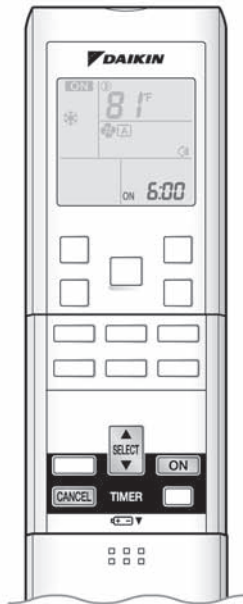

■ To use ON TIMER operation

- Check that the clock is correct.
If not, set the clock to the present time. ▶Page 9

1. Press **ON**.



2. Press **SELECT** until the time setting reaches the point you like.

- Every pressing of either button increases or decreases the time setting by 10 minutes. Holding down either button changes the setting rapidly.

3. Press **ON** again.

- The TIMER lamp lights up.



Control panel

■ To cancel OFF TIMER Operation

Press **CANCEL**.

- The TIMER lamp goes off.

■ To combine ON TIMER and OFF TIMER

- A sample setting for combining the two timers is shown below.

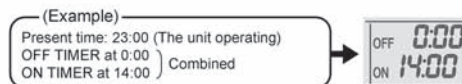

ATTENTION

■ In the following cases, set the timer again.

- After a breaker has turned OFF.
- After a power failure.
- After replacing batteries in the remote controller.

Care and Cleaning



CAUTION

Before cleaning, be sure to stop the operation and turn the breaker OFF.

Units

■ Indoor unit, Outdoor unit and Remote controller

Wipe them with dry soft cloth.

Front panel

1. Open the front panel.

- Hold the panel by the tabs on the two sides and lift it until it stops with a click.

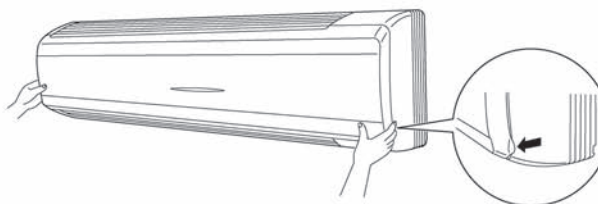

2. Remove the front panel.

- Open the front panel further while sliding it to either the left or right and pulling it toward you. This will disconnect the rotation dowel on one side. Then disconnect the rotation dowel on the other side in the same manner.

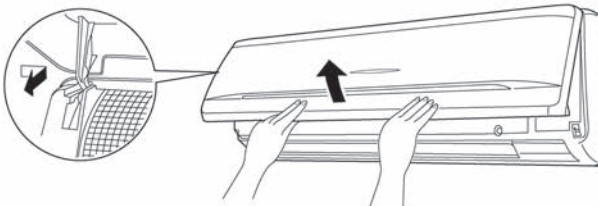

3. Clean the front panel.

- Wipe it with a soft cloth soaked in water.
- Only neutral detergent may be used.
- In case of washing the panel with water, wipe it with dry soft cloth, dry it up in the shade after washing.

4. Attach the front panel.

- Align the rotation dowels on the left and right of the front panel with the slots, then push them all the way in.
- Close the front panel slowly. (Press the panel at both sides and the center.)

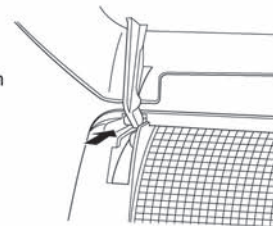

CAUTION

- Do not touch the metal parts of the indoor unit. If you touch those parts, this may cause an injury.
- When removing or attaching the front panel, use a robust and stable stool and watch your steps carefully.
- When removing or attaching the front panel, support the panel securely with hand to prevent it from falling.
- For cleaning, do not use hot water above 104°F(40°C), benzine, gasoline, thinner, nor other volatile oils, polishing compound, scrubbing brushes, nor other hand stuff.
- After cleaning, make sure that the front panel is securely fixed.

Filters

1. Open the front panel. ▶Page 24

2. Pull out the air filters.

- Push a little upwards the tab at the center of each air filter, then pull it down.

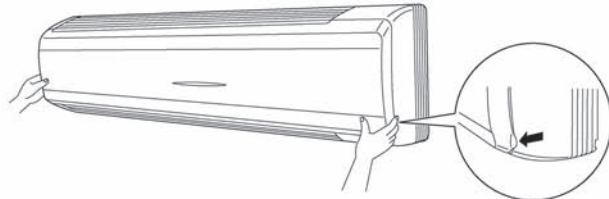

3. Take off the Air-purifying filter with photocatalytic deodorizing function.

- Press the top of the aircleaning filter onto the tabs (3 tabs at top). Then press the bottom of the filter up slightly, and press it onto the tabs (3 at bottom).

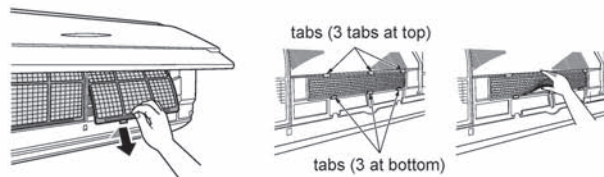

4. Clean or replace each filter.

See figure.

5. Set the air filter and the Air-purifying filter with photocatalytic deodorizing function as they were and close the front panel.

- Press the front panel at both sides and the center.

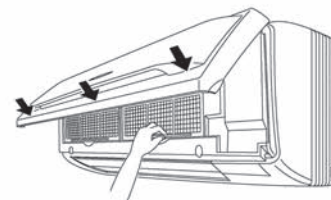

CAUTION

- Do not touch the aluminum fins by bare hand at the time of dismantling or mounting the filter.

Care and Cleaning

Air Filter

Wash the air filters with water or clean them with vacuum cleaner.

- If the dust does not come off easily, wash them with neutral detergent thinned with lukewarm water, then dry them up in the shade.
- It is recommended to clean the air filters every 2 weeks.



Air-purifying filter with photocatalytic deodorizing function

The Air-purifying filter with photocatalytic deodorizing function can be renewed by washing it with water once every 6 months. We recommend replacing it once every 3 years.

[Maintenance]

- 1. Vacuum dusts, and soak in warm water or water for about 10 to 15 minutes if dirt is heavy.**
- 2. Do not remove filter from frame when washing with water.**
- 3. After washing, shake off remaining water and dry in the shade.**
- 4. Since the material is made out of paper, do not wring out the filter when removing water from it.**

[Replacement]

- 1. Remove the tabs on the filter frame and replace with a new filter.**

- Dispose of the old filter as flammable waste.

NOTE

- Operation with dirty filters:
 - 1) cannot deodorize the air.
 - 2) cannot clean the air.
 - 3) results in poor HEAT or COOL.
 - 4) may cause odor.
- To order Air-purifying filter with photocatalytic deodorizing function contact to the service shop there you bought the air conditioner.
- Dispose of old filters as flammable waste.

Item	Part No.
Air-purifying filter with photocatalytic deodorizing function (without frame) 1 set	KAF952A42



ATTENTION

- Do not throw away the filter frame. Reuse the filter frame when replacing the Air-purifying filter with photocatalytic deodorizing function.

CHECK

- Check that the base, stand and other fittings of the outdoor unit are not decayed or corroded.
- Check that nothing blocks the air inlets and the outlets of the indoor unit and the outdoor unit.
- Check that the drain comes smoothly out of the drain hose during COOL or DRY operation.
 - If no drain water is seen, water may be leaking from the indoor unit. Stop operation and consult the service shop if this is the case.

Before a long idle period

- 1. Operate the “FAN only” for several hours on a fine day to dry out the inside.**
 - Press **MODE** and select “” operation.
 - Press  and start operation.
- 2. After operation stops, turn off the breaker for the room air conditioner.**
- 3. Clean the air filters and set them again.**
- 4. Take out batteries from the remote controller.**

Trouble Shooting

These cases are not problems.

The following incidents are not problems with the air conditioner but might require an understanding of how it operates.

Case	Explanation
Operation does not start soon. <ul style="list-style-type: none"> When ON/OFF button was pressed soon after operation was stopped. When the mode was reselected. 	<ul style="list-style-type: none"> This is to protect the air conditioner. You should wait for about 3 minutes.
Hot air does not flow out soon after the start of heating operation.	<ul style="list-style-type: none"> The air conditioner is warming up. You should wait for 1 to 4 minutes. (The system is designed to start discharging air only after it has reached a certain temperature.)
The heating operation stops suddenly and a flowing sound is heard.	<ul style="list-style-type: none"> The system is taking away the frost on the outdoor unit. You should wait for about 4 to 12 minutes.
The outdoor unit emits water or steam.	<ul style="list-style-type: none"> In HEAT mode <ul style="list-style-type: none"> The frost on the outdoor unit melts into water or steam when the air conditioner is in defrost operation. In COOL or DRY mode <ul style="list-style-type: none"> Moisture in the air condenses into water on the cool surface of outdoor unit piping and drips.
Mist comes out of the indoor unit.	<ul style="list-style-type: none"> This happens when the air in the room is cooled into mist by the cold airflow during cooling operation. This is because the air in the room is cooled by the heat exchanger and becomes mist during defrost operation.
The indoor unit gives out odour.	<ul style="list-style-type: none"> This happens when smells of the room, furniture, or cigarettes are absorbed into the unit and discharged with the airflow. (If this happens, we recommend you to have the indoor unit washed by a technician. Consult the service shop where you bought the air conditioner.)
The outdoor fan rotates while the air conditioner is not in operation.	<ul style="list-style-type: none"> After operation is stopped: <ul style="list-style-type: none"> The outdoor fan continues rotating for another 60 seconds for system protection. While the air conditioner is not in operation: <ul style="list-style-type: none"> When the outdoor temperature is very high, the outdoor fan starts rotating for system protection.
The operation stopped suddenly. (OPERATION lamp is on.)	<ul style="list-style-type: none"> For system protection, the air conditioner may stop operating on a sudden large voltage fluctuation. It automatically resumes operation in about 3 minutes.
No remote controller signals are displayed. The remote controller sensitivity is low. The display is low in contrast or blacked out. The display runs out of control.	<ul style="list-style-type: none"> The batteries are dying and the remote controller is malfunctioning. Replace all the batteries with new size batteries, AAA.LR03 (alkaline). For details, refer to "To set the batteries" of this manual. ▶Page 8

Check again.

Please check again before calling a repair person.

Case	Check
<p>The air conditioner does not operate. (OPERATION lamp is off.)</p>	<ul style="list-style-type: none"> • Hasn't a breaker turned OFF or a fuse blown? • Isn't it a power failure? • Are batteries set in the remote controller? • Is the timer setting correct?
<p>Cooling (Heating) effect is poor.</p>	<ul style="list-style-type: none"> • Are the air filters clean? • Is there anything to block the air inlet or the outlet of the indoor and the outdoor units? • Is the temperature setting appropriate? • Are the windows and doors closed? • Are the airflow rate and the air direction set appropriately?
<p>Operation stops suddenly. (OPERATION lamp flashes.)</p>	<ul style="list-style-type: none"> • Are the air filters clean? • Is there anything to block the air inlet or the outlet of the indoor and the outdoor units? Clean the air filters or take all obstacles away and turn the breaker OFF. Then turn it ON again and try operating the air conditioner with the remote controller. If the lamp still flashes, call the service shop where you bought the air conditioner.
<p>An abnormal functioning happens during operation.</p>	<ul style="list-style-type: none"> • The air conditioner may malfunction with lightning or radio waves. Turn the breaker OFF, turn it ON again and try operating the air conditioner with the remote controller.
<p>The fin does not start swinging immediately.</p>	<ul style="list-style-type: none"> • The air conditioner is adjusting the fin position. The fin will start moving soon.

Trouble Shooting

- Call the service shop immediately.

WARNING

- When an abnormality (such as a burning smell) occurs, stop operation and turn the breaker OFF.
Continued operation in an abnormal condition may result in troubles, electric shocks or fire.
Consult the service shop where you bought the air conditioner.
- Do not attempt to repair or modify the air conditioner by yourself.
Incorrect work may result in electric shocks or fire.
Consult the service shop where you bought the air conditioner.

If one of the following symptoms takes place, call the service shop immediately.

- The power cord is abnormally hot or damaged.
- An abnormal sound is heard during operation.
- The safety breaker, a fuse, or the ground leakage breaker cuts off the operation frequently.
- A switch or a button often fails to work properly.
- There is a burning smell.
- Water leaks from the indoor unit.

Turn the breaker OFF and call the service shop.



- After a power failure

The air conditioner automatically resumes operation in about 3 minutes. You should just wait for a while.

- Lightning

If lightning may strike the neighboring area, stop operation and turn the breaker OFF for system protection.

- We recommend periodical maintenance.

In certain operating conditions, the inside of the air conditioner may get foul after several seasons of use, resulting in poor performance. It is recommended to have periodical maintenance by a specialist aside from regular cleaning by the user. For specialist maintenance, contact the service shop where you bought the air conditioner. The maintenance cost must be born by the user.

Fault diagnosis.

FAULT DIAGNOSIS BY REMOTE CONTROLLER

In the ARC452A series, the temperature display sections on the main unit indicate corresponding codes.

1. When the **TIMER CANCEL** button is held down for 5 seconds, a “00” indication flashes on the temperature display section.

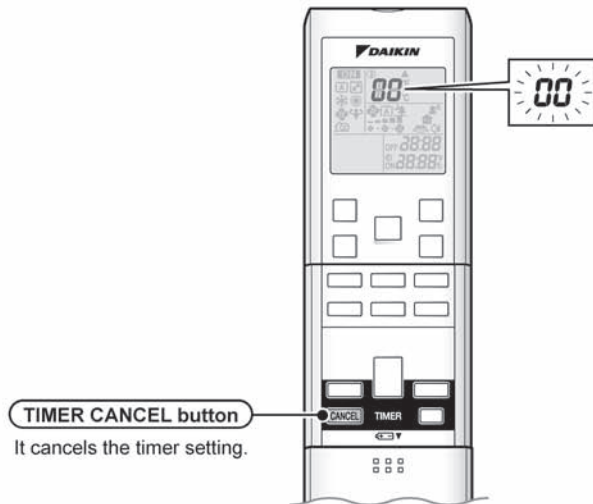

2. Press the **TIMER CANCEL** button repeatedly until a continuous beep is produced.

• The code indication changes as shown below, and notifies with a long beep.

	CODE	MEANING
SYSTEM	00	NORMAL
	U0	REFRIGERANT SHORTAGE
	U2	DROP VOLTAGE OR MAIN CIRCUIT OVERVOLTAGE
	U4	FAILURE OF TRANSMISSION (BETWEEN INDOOR UNIT AND OUTDOOR UNIT)
INDOOR UNIT	A1	INDOOR PCB DEFECTIVENESS
	A5	HIGH PRESSURE CONTROL OR FREEZE-UP PROTECTOR
	A6	FAN MOTOR FAULT
	C4	FAULTY HEAT EXCHANGER TEMPERATURE SENSOR
OUTDOOR UNIT	C9	FAULTY SUCTION AIR TEMPERATURE SENSOR
	EA	COOLING-HEATING SWITCHING ERROR
	E5	OL STARTED
	E6	FAULTY COMPRESSOR START UP
	E7	DC FAN MOTOR FAULT
	E8	OPERATION HALT DUE TO DETECTION OF INPUT OVER CURRENT
	F3	HIGH TEMPERATURE DISCHARGE PIPE CONTROL
	H6	OPERATION HALT DUE TO FAULTY POSITION DETECTION SENSOR
	H8	CT ABNORMALITY
	H9	FAULTY SUCTION AIR TEMPERATURE SENSOR
	J3	FAULTY DISCHARGE PIPE TEMPERATURE SENSOR
	J6	FAULTY HEAT EXCHANGER TEMPERATURE SENSOR
	L4	HIGH TEMPERATURE AT INVERTER CIRCUIT HEATSINK
	L5	OUTPUT OVERCURRENT
P4	FAULTY INVERTER CIRCUIT HEATSINK TEMPERATURE SENSOR	

NOTE

1. A short beep and two consecutive beeps indicate non-corresponding codes.
2. To cancel the code display, hold the **TIMER CANCEL** button down for 5 seconds. The code display also cancels itself if the button is not pressed for 1 minute.

13. Optional Accessories

13.1 Option List

13.1.1 Indoor Units

	Option Name	FTXS09/12HVJU	FTXS15/18/24HVJU
1	Centralized Control Board-Up to 5 Rooms ★1	KRC72	
2	Wiring Adapter for Time Clock / Remote Control ★2 (Normal Open Pulse Contact / Normal Open Contact)	KRP413A1S	
3	Central Remote Controller ★1	DCS302C71	
4	Unified ON/OFF Controller ★1	DCS301C71	
5	Schedule Timer Controller ★1	DST301BA61	
6	Interface Adapter for Room Air Conditioner	KRP928B2S	
7	Air-Purifying Filter with Photocatalytic Deodorizing Function (with Frame)	KAF918A43	—
8	Air-Purifying Filter with Photocatalytic Deodorizing Function (without Frame)	KAF918A44	KAF952A42
9	The Remote Controller Loss Prevention with the Chain	KKF917A4	

Note: ★1 Wiring adapter is also required for each indoor unit.
★2 Time clock and other devices ; obtained locally.

13.1.2 Outdoor Units



	Option Name	RX09/12FAVJU	RX15/18/24FVJU
1	Drain Plug	KKP937A4	
2	Air Direction Adjustment Grille	KPW937A4	KPW945A4

13.2 Installation Manual



13.2.1 KRP413A1S

Safety Precautions

- Read these safety precautions carefully before installing the unit, and be sure to install the unit properly.
- This manual classifies precautions to the user into the following two categories. These warnings and cautions are for your safety. Follow them.

 WARNING	Faulty installation can result in death or serious injury
 CAUTION	Faulty installation can result in serious injury or other serious consequences.

- Below is a key to symbols used in this manual.

	Be sure to follow instructions.
	Be sure to perform grounding work.
	Never attempt.

- After installation is complete, test the unit to confirm that it is working properly, and instruct the owner its proper use.

WARNING

- Installation should be left to the dealer from whom you purchased the unit, or another qualified professionals.
- Install the unit securely according to the installation manual. Faulty installation may lead to electric shock or fire.
- Be sure to use the supplied or specified parts. Using other parts may lead to electric shock or fire.
- Install the unit securely in a location that will support its weight. If installed in a poor location or improperly installed, the unit may not work as intended.
- For electrical work, follow local electric standards and the installation manual. Faulty installation may lead to fire or electric shock.
- Do not bundle the power cord, or attempt to extend it by splicing it with another cord or by using an extension cord. Do not place any other load on the power circuit used for the unit. Improper wiring may lead to electric shock, heat generation or fire.
- Use dedicated wiring for all electrical connections, and be sure to arrange the wiring so that force applied to the wiring will not damage the terminals. Poor wiring or installation may cause electric shock, heat generation or fire.

CAUTION

- Before installation, unplug the air conditioner to ensure safety. Failure to do so may cause electric shock.
- Static electricity may damage electric components. Before connecting cables and communication lines, and operating the switches, be sure to discharge any electrical charge from your body (by, for example, touching the earth line)
- Do not install the unit in a location where it may be exposed to flammable gases. If gas leaks and build up around the unit, it may catch fire.
- Do not place the wiring close to the power cord, inter-unit cable, or pipes which generate noise. Treat the wiring with care.

1. Functions and Features

- On/Off setting
- Switching between Instantaneous Contact/Normal Contact
- Connection with five-room central controller (KRC72 for oversea model)
- Connection with fan coil remote controller
- Automatic reset after power failure
- Output of normal operation signals/malfunction signals

2. Field Wiring

For interconnecting wiring, use Daikin KDC100A12 cable (not supplied) or other similar cable. The cable should have the specifications shown below.

■ Optional cable KDC100A12 (without connectors)

Specifications: 0.2 mm² × 4 conductors (sheathed)
 Outer diameter: φ 5.3
 Length: 328 ft
 Color: Grey

■ Other cable (commercially available)

Item	Outer dia.	Remarks
Cable for instrumentation (IPVV) 0.3 mm ² × 4-core	7.2 mm	Hard sheath
Microphone cord (MVVS) 0.3 mm ² × 4-core	8.0 mm	Shielded
Microphone cord (MVVS) 0.2 mm ² × 4-core	6.5 mm	
Microphone cord (MVVS) 0.15 mm ² × 4-core	4.8 mm	
Intercom cable 0.65 mm ² dia. × 4-core		
PVC jumper wire (TJVC) (from 0.5 mm dia. × 4 pcs.)	—	Not sheathed

Note 1: Keep any wiring for the control unit away from the power cord to prevent electrical noise.

Note 2: Do not use cables shown above for power cord, inter-unit cord/cable or power cord for lamps.

Installation

This product is available in two types. The **KRP413A1S · KRP413AA1S** is for installation in a case independent of the indoor unit, and the **KRP413A1** is for installation within the indoor unit.

1. KRP413A1S · KRP413AA1S

1 Installation diagram

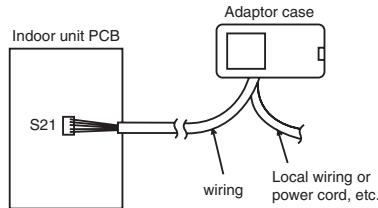

2 Components

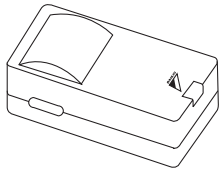
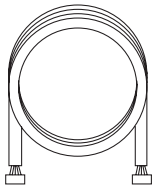
<p>① Adaptor case assy (Adaptor (PCB) is attached in the adaptor case.)</p> 	<p>② Wiring (approx. 0.8 m)</p> 
<p>③ Accessories</p> <ul style="list-style-type: none"> • Binding band (4 pcs.) • Securing tape for attaching to the indoor unit (2 sets) • Screws for attaching the adaptor case (4 pcs.) • Screws for attaching to the wall (3 pcs.) 	
<p>④ Installation manual</p>	

2. KRP413A1

For this type, install the adaptor PCB within the indoor unit. The method of installation and connection vary depending on the model of the air conditioner. See your air conditioner installation manual for details.

1 Components

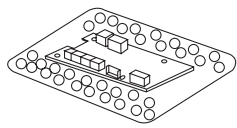
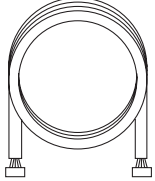
<p>① Adaptor PCB</p> 	<p>② Wiring (approx. 0.25 m)</p> 
<p>③ Installation manual</p>	

3. Attaching Adaptor Case Assy (for KRP413A1S · KRP413AA1S)

1 Using the screws (to mount on a wall, etc.)

- Use the 3 supplied screws to attach the case assy .

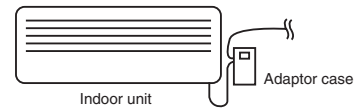

- Install the adaptor case assy as close to the indoor unit as possible.
- ① Removing case front

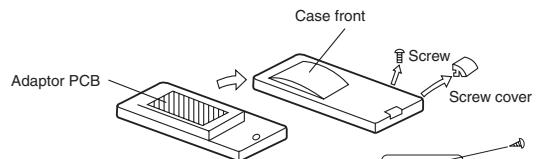

- Remove the screw cover, one of the screws and then the case front.
- ② Attach the case back to the surface by tightening the screws through the screw holes (one round hole, two long holes).
 - ③ After connecting the cables (refer to the following sections), replace the case front. Be careful not to damage the wiring in the case.

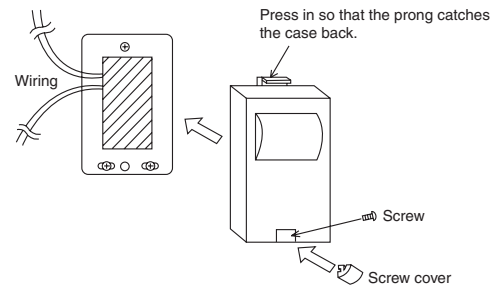

2 Using securing tape (to attach on the indoor unit)

- Attach the adaptor case with the supplied securing tape.
- ① Remove the case front (as for mounting on a wall).
 - ② After connecting the cables (see the following sections), replace the case front. It can be screwed to the case back from the rear with the four supplied screws.
Be careful not to damage the wiring in the case.
 - ③ Attach the hook side (loop side) of the included securing tape to the rear surface of the HA case, then attach the loop side (hook side) to the top of the air conditioner unit spaced at the same intervals.

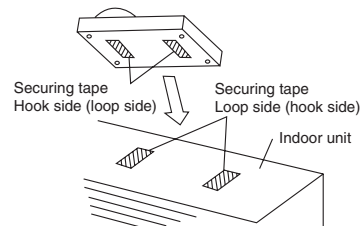

To prevent the adaptor case assy from falling, do not use the securing tape for attaching it to a wall or other surface.

Wiring

1. Wiring

- ① Connect one end of the wiring to connector S21 of the PCB in the indoor unit.
- ② Connect the other end of the wiring to connector S6 of the adaptor PCB.
- ③ Connect field wiring according to the functions assigned to each connection terminal of the adaptor PCB.
- ④ Secure all wires.

1 Securing wires in the adaptor case assy (for KRP413A1S · KRP413AA1S)

- Fasten with a tie-wrap so that wires will not come loose even if pulled.

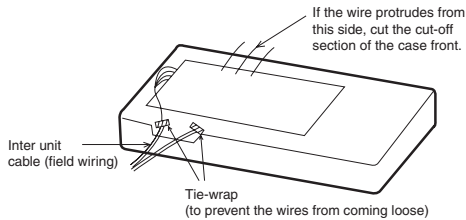

2 Securing wires in the indoor unit (for KRP413A1)

- The method for securing wire varies depending on the model of the air conditioner. See your air conditioner installation manual for details.

2. Automatic Reset After Power Failure

- This PCB stores the following data in the event of a power failure (common features).
 - ① On/Off (see Note 1)
 - ② Operation modes
 - ③ Temperature setting
 - ④ Air flow rate
 - ⑤ On/Off status of remote controller
 (Note 1 When SW1-2 is in Off mode, the unit will not be activated.)

3. Monitor Signal Output (normal operation and malfunction)

- Maximum length of the wiring is 100 m.

1 Monitor signal output for LED

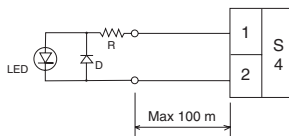

■ Locally procured parts

Item	Manufacturer	Type
LED	Toshiba	TLG208 (green) TLR208 (red)
D	Rohm	1S2473
R		510 ohm 1/4W

2 Monitor signal output (normal operation and malfunction) using external relay contacts

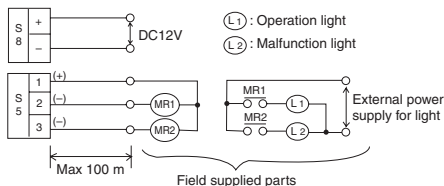

■ Field procured parts (Recommended external relay contacts)

Manufacturer	Type	Coil rated voltage	Coil resistance
Omron	MY relay	12 V DC	160 ohm ± 10%
Matsushita	HC relay	12 V DC	160 ohm ± 10%

4. Connection with Remote Controller

Example connections with three kinds of remote controllers are shown below.

Note: These connections cannot be used in combination.

1 Generic remote controller

- Set SW1-1 to Off and select Operation Mode 1.



<Instantaneous Contact>

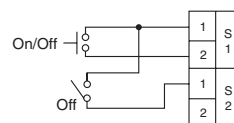

- The remote controller most recently used (local or air conditioner) takes precedence.
- Use a remote controller with a pulse width of 100 msec or more.

<Normal Contact>

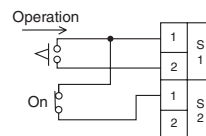

- Power On/Off cannot be controlled from the unit's remote controller.
- When power is restored after a power failure in this mode, On or Off is determined according to the current settings of the remote controller.

2 Five-room central controller (KRC72)

- Set SW1-1 to Off and select Operation Mode 1.
- The remote controller most recently used takes precedence.

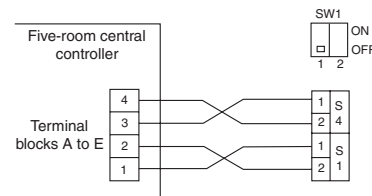

3 Fan coil remote controller

- Set SW1-1 to On and select Operation Mode 2.
- Most settings (power On/Off, air flow rate, mode change) cannot be made using the air conditioner's remote controller.
- When power is restored after a power failure in this mode, On or Off is determined according to the current settings of the remote controller.
- When the Cooling /Heating mode is changed, use the air conditioner's remote controller to adjust the temperature.

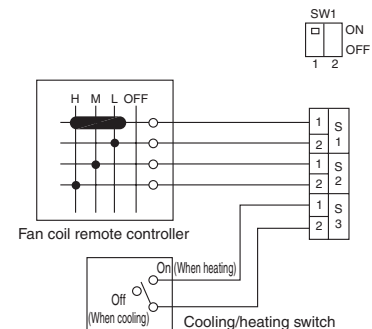

Test Operation and Confirmation

1. When the System is Not Working

- Is the air conditioner working properly?
- Are the connectors of the wiring properly connected?
- Are the remote controller and field wiring properly connected?
- Are all switch settings correct?
- If there is nothing apparently wrong, conduct a diagnostic check using the following procedure.

■ Diagnostic check

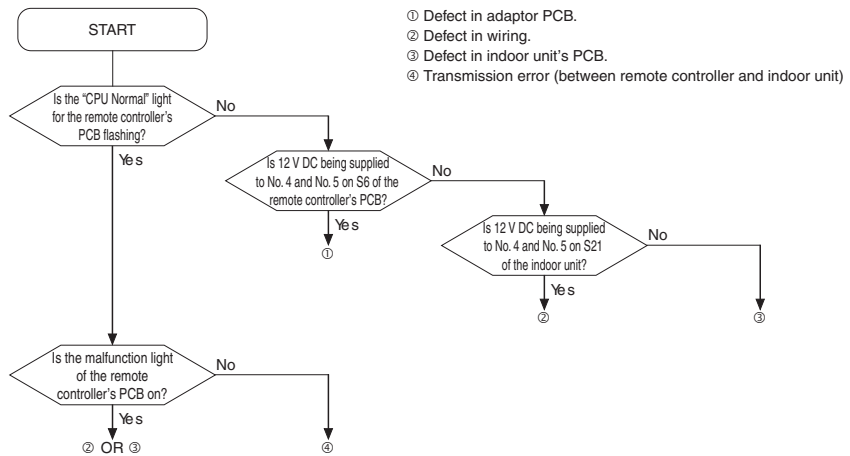

2. Switch Settings and Connection Terminals

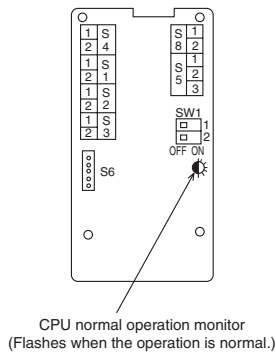

SW1-1	Selecting the operation mode	OFF	Operation mode 1 (Used with the exception of fan coil remote controller settings)	
		ON	Operation mode 2 (Used with fan coil remote controller settings)	
SW1-2	Selecting On/Off when power is restored after a power failure	OFF	Always Off	
		ON	Off if operation was in Off mode before power failure; On if operation was in On mode before power failure	
S1	SW1-1: OFF (Operation mode 1)	S1 (1) - S2 (1)	Instantaneous contact	Normal contact
		S1 (1) - S1 (2)	OPEN	CLOSE
S2	SW1-1: ON (Operation mode 2)	Pulse input On/Off switching		OPEN, Not activated
		S2 (2), S3	Not used	
S3	SW1-1: ON (Operation mode 2)	S1, S2 OPEN	Not activated	
		S1 (1) - S1 (2) CLOSE	On, airflow: L tap	
S4	(1) - (2)	S1 (1) - S2 (1) CLOSE	On, airflow: M tap	
		S1 (1) - S2 (2) CLOSE	On, airflow: H tap	
S5	(1) - (3)	S3 (With the remote controller only)	OPEN, Cooling	
			CLOSE, Heating	
S6 connector	(1) - (2)	Voltage on (DC12 V), normal operation light output		
S8	(+) - (-)	Normal operation light output (power for light required)		
		Malfunction light output (power for light required)		
S6 connector		Connect with connector S21 on the PCB of the indoor unit		
S8		Relay DC 12 V power supply terminal (Field supplied parts)		

13.2.2 KRP928B2S

Safety Precautions

- Read these Safety Precautions carefully to ensure correct installation.

This manual classifies precautions into WARNING and CAUTION.

WARNING : Failure to follow WARNING is very likely to result in such grave consequences as death or serious injury.

CAUTION : Failure to follow CAUTION may result in serious injury or property damage, and in certain circumstances, may result in a grave consequence.

Be sure to follow all the precautions below; they are all important for ensuring safety.

WARNING

- **Installation should be left to the dealer or another qualified professional.**
Improper installation by yourself may cause malfunction, electrical shock, or fire.
- **Install the set according to the instructions given in this manual.**
Incomplete or improper installation may cause malfunction, electrical shock, or fire.
- **Be sure to use the standard attachments or the genuine parts.**
Use of other parts may cause malfunction, electrical shock, or fire.
- **Disconnect power to the connected equipment before starting installation.**
Failure to do so may cause malfunction, electrical shock, or fire.

CAUTION

- **A ground leakage circuit breaker should be installed**
If the breaker is not installed, electrical shock may occur.
- **Do not install the set in a location where there is danger of exposure to inflammable gas.**
Gas accumulated around the unit at the worst may cause fire.
- **To prevent damage due to electrostatic discharge, touch your hand to a nearby metal object (doorknob, aluminum sash, etc.) to discharge static electricity from your body before touching this kit.**
Static electricity can damage this kit.
- **Lay this cable separately from other power cables to avoid external electrical noises.**

- After installation is complete, test the operation of the PCB set to check for problems, and explain how to use the set to the end-user.

1. Overview, Features and Compatible Models

This kit is the interface required when connecting the central controller and a Daikin Room Air Conditioner. Use of the central controller makes it possible to perform the following monitoring and operations. It is compatible with room air conditioners which have an HA connector S21.

1. Run / stop for the central controller and wired remote controller, operating mode selection, and temperature can be set.
2. The operating status, any errors, and the content of those errors can be monitored from the central controller and wired remote controller.
3. Run / stop for the central controller and wireless remote controller, operating mode selection, and the temperature setting can be limited by the central controller.
4. Zone control can be performed from the central controller.
5. The unit can remember the operating status of the air conditioner before a power outage and then start operating in the same status when the power comes back on.
6. Card keys, operating control panels, and other constant / instantaneous connection-compatible equipment can be connected.
7. The Operating / error signals can be read.
8. HA JEM-A-compatible equipment can be connected.
9. The indoor temperature can be monitored from the Ve-up controller.

Precaution

1. When reading the Operating / error signals, a separate external power source (DC 12V) is needed.
2. A separate timer power source (DC 16V) is needed when using the schedule timer independently, and not in conjunction with other central controllers.
3. The range of temperatures that can be set from the central controller is 18°C to 32°C in cooling and 14°C to 28°C in heating.
4. Fan operation cannot be selected from the central controller or wired remote controller.
5. Group control (i.e., control of multiple indoor units with a single remote controller) is not available.
6. Monitoring is not available of the thermo status, compressor operating status, indoor fan operating status, electric heater, or humidifier operating status.
7. Forced thermo off, filter sign display and reset, fan direction and speed settings, air conditioning fee management, energy savings instructions, low-noise instructions, and demand instructions cannot be made.

2. Component Parts and Separately-Sold Parts which are Required

This kit includes the following components. Check to ensure that none of these are missing.

Parts	Q'ty	Parts	Q'ty
Kit assy PCB is in the housing.	1	Connection harness (about 1.6m)	1set
		Mounting screws	3pcs.
		Binding band	1pc.
		Installation manual	1set

3. Names of Parts and Electric Wiring

<Wiring procedure>

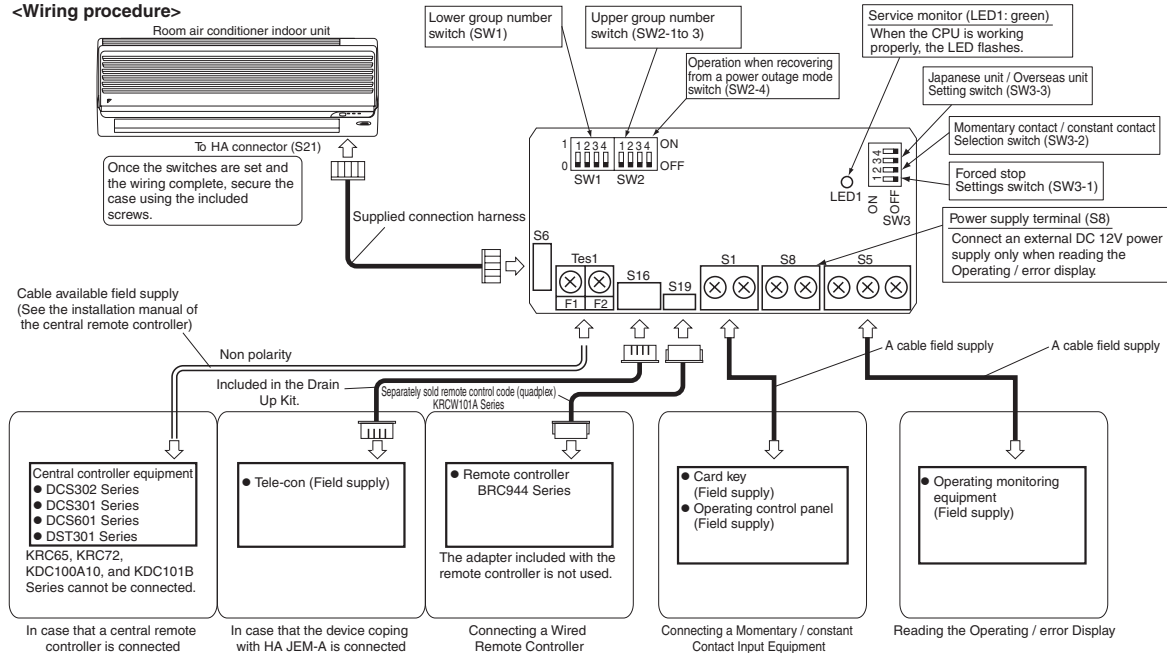

4. Switch Settings

NOTE Turn the power on after all the switches have been set. Settings made while the power is on are invalid.

Open the Kit's case and set the switches on the circuit board.

(1) For Overseas / Japanese unit setting (SW3-3)

Room air conditioners, different methods are used for setting the temperature in automatic mode, so this switch needs to be set.

Destination	SW3-3 setting	What Happens
Japan	OFF (Factory setting)	• "Automatic" operation is not available from the central controller. When using "automatic" operation using the wireless remote controller, the central controller displays automatic cooling (heating) and 77°F (25°C). Even if the temperature is changed, it will return to 77°F (25°C) after a while.
Overseas	ON	• "Automatic" operation is available from the central controller.

(2) Group number settings (SW1 and SW2-1 to SW2-3)

Set these when using the central controller. (Set to the ■ side.) Do not set more than one unit to the same number.

However, these settings do not need to be made when using the schedule timer independently. (The settings are needed when used in conjunction with another DCS Series central controller.) In this case, the schedule timer performs an auto address after the power is turned on, so new group numbers are automatically set. Settings made using the switches will be overwritten.

SW2 setting	Upper group NO.	SW1 setting	Lower group NO.	SW1 setting	Lower group NO.
1	1	0	0	0	8
2	2	0	1	0	9
3	3	0	2	0	10
4	4	0	3	0	11
5	5	0	4	0	12
6	6	0	5	0	13
7	7	0	6	0	14
8	8	0	7	0	15

NOTE also that a separate timer power source is needed when using the schedule timer independently. Power source specs: DC 16V, +10%, -15%, 200mA. Recommended power source: Omron S82J-01015A. (Should be used with the output voltage adjusted to the center, DC 16V.)

(3) Settings when recovering from a power outage (SW2-4)

This selects whether to restart operation when the power comes back on after a power outage occurred during operation. This setting is given priority in cases where the indoor unit has an auto start ON / OFF jumper. Note also that regardless of whether switch SW2-4 is on or off, the operating mode, set temperature, fan direction and speed settings, and remote control prohibition status are stored.

SW2-4 setting	What Happens
OFF (Factory setting)	Stops after recovering from a power outage
ON	Stops if the unit was stopped before the power outage and runs if it was running.

(4) Contact input function settings (SW3-1 to SW3-2)

When using contact input (S1), choose one of the following functions.

S1 operating mode	SW3-1 setting	SW3-2 setting	What Happens	Control mode
Instantaneous contact input (factory setting)	OFF	OFF	The operating status of the air conditioner is reversed by an instantaneous input of 100 msec or more.	Last command priority
Constant contact input	ON	ON	Contact - Open to close: air condition runs. Close to open: air conditioner is stopped (NOTE 1).	ON / OFF control is rejected (operate / stop / timer prohibition) (NOTE 2).
Forced stop or remote controller permission input	ON	Invalid	Contact - Open to close: air condition stops (forced stop). Close to open: no change in operating status.	During a forced stop, all remote controller actions are prohibited.

NOTE1: Since central equipment and HA JEM-A-compatible equipment both use last command priority, the contact status and operating status of the air conditioner might not match sometimes.

Example: If the unit is run from the central controller while the air conditioner is stopped with an open contact, the contact will be open and the unit will be running.

NOTE2: Operating mode and fan direction and speed settings can be changed.

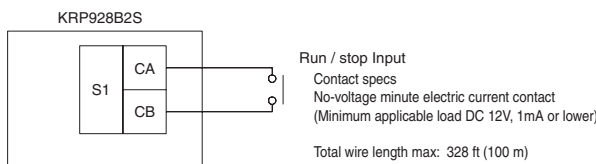

5. Control Codes

When using a central remote controller, the operating codes can be used to limit operation from wireless remote controllers.

○ : permitted; ◯ : prohibited

S1 operating mode	Control mode	Control code	Operations from the remote controller				Operations from central controller, contact input and HA JEM-A input
			"Run" control from the central controller	"Stop" control from the central controller	Operating mode temperature	Fan direction and fan speed	
Instantaneous contact mode	ON / OFF control is rejected	0,1,3	○	○	○	○	○
	Only OFF control is accepted	2, 12-19	○	○	○	○	
	Central priority	4, 5	○	○	○	○	
	Last command priority	6,7	○	○	○	○	
	Timer operation is accepted by remote controller	8, 9	○	○	○	○	
Constant contact mode	2,10-19	○	○	○	○	○	
	0,1,3,5-7	○	○	○	○		
	4	○	○	○	○		
	8	○	○	○	○		
Forced stop		9	○	○	○	○	

*Only during timer operation

The remote controller permission / prohibition settings using the Ve-up controller are as follows.

○ : permitted; ◯ : prohibited

S1 pin operating mode	Ve-up controller settings			Operations from the remote controller			Operations from central controller, contact input and HA JEM-A input
	Start / stop	Change operating mode	Change set temperature	Run / timer	Stop	Operating mode temperature	
Instantaneous contact mode	ON / OFF control is rejected	permitted	permitted/prohibited	○	○	○	○
Constant contact mode	permitted	permitted/prohibited	permitted/prohibited	○	○	○	
Instantaneous contact mode	Only OFF control is accepted	permitted	permitted/prohibited	○	○	○	○
Constant contact mode	permitted	permitted	permitted/prohibited	○	○	○	
Instantaneous contact mode	Last command priority	permitted	permitted/prohibited	○	○	○	○
Constant contact mode	permitted	permitted/prohibited	permitted/prohibited	○	○	○	
Forced stop	Does not affect settings			○	○	○	

6. Read Operating / Error Display Signal

The Operating / error signals can be read from the contact output (S5).

Output specs

M1: Turn MR 1 ON when the air conditioner is running.

M2: Turn MR 2 when a communication error has occurred between the KRP928B2S and the air conditioner, or MR 1 is ON and the unit has stopped after an error.

MR 2 is not turned ON during a warning.

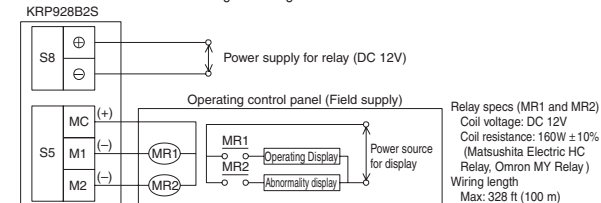

7. Combining Equipment

The central controller can be combined with the following devices.

	Central Remote Controller	ON / OFF controller	Schedule timer	D-BIPS	Forced stop contact input	Constant contact input	Instantaneous contact input	HA JEM-A-compatible equipment	Wired Remote Controller	Wireless Remote Controller
Central Remote Controller	○	○	○	○	○	○	○	○	○	○
ON / OFF controller	○	○	○	○	○	○	○	○	○	○
Schedule timer	○	○	○	○	○	○	○	○	○	○
D-BIPS	○	○	○	○	○	○	○	○	○	○
Forced stop contact input	○	○	○	○	○	○	○	○	○	○
Constant contact input	○	○	○	○	○	○	○	○	○	○
Instantaneous contact input	○	○	○	○	○	○	○	○	○	○
HA JEM-A-compatible equipment	○	○	○	○	○	○	○	○	○	○
Wired Remote Controller	○	○	○	○	○	○	○	○	○	○
Wireless Remote Controller	○	○	○	○	○	○	○	○	○	○



3P157704-2B

13.2.3 KPW937A4

■ Before Installation

Checking the parts

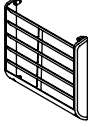
Check the following parts

Name	Louver	Installation manual
Shape		
	With 4 screws	
Quantity	1 piece	1 piece

■ Installation Procedure

Selection of Installation Location

Use when installing in a location that meets the following conditions.

- When installing near the border to a neighbor's house
- If exhaust blows directly on passers-by because outdoor unit is installed facing a road.
- Changing the fan direction of the outdoor unit to prevent it blowing directly on shrubbery, etc.

Installation of Louver

- Installation is possible in the four directions: upward, downward, rightward, and leftward.
- The installation screws are attached to the louver.
- First temporarily attach the louver with 4 screws, then check that the angle is correct, and finally tighten the screws fully.

⚠ CAUTION

1. Install so that a short circuit is prevented.
2. For the use in snowy regions, avoid installation with the air outlet facing upward. Install so that the air outlet faces leftward, rightward, or downward. Snow accumulates in the air outlet of the outdoor unit, causing malfunction of the main body of the outdoor unit.
3. Be advised that if the fan direction is up, dead leaves and other foreign matter easily accumulates in the exhaust vent.

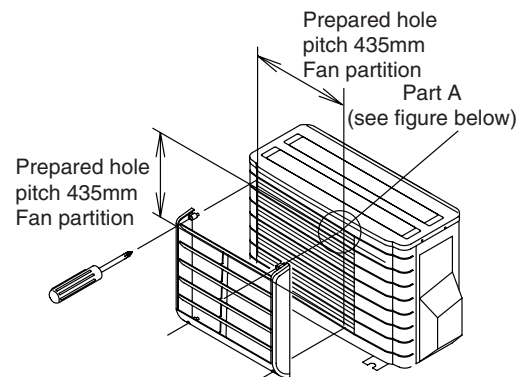

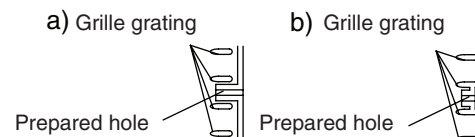

The prepared hole is in between the grating of the grille. Part A (prepared hole) cross section (the shape of either a or b)



4P104499-1A

13.2.4 KPW945A4

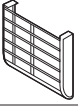
■ Before installation

Check the following parts	Name	Louver	Truss tapping screw	Installation manual
	Shape			
	Quantity	1piece	M4x4screws(max.7.5kW class) M5x4screws(8.0/9.0kW class)	1piece

■ Installation Procedure

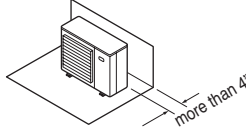
Selection of Installation Location	Space Needed for Installation
<p>Use when installing in a location that meets the following conditions.</p> <ul style="list-style-type: none"> ● When installing near the border to a neighbor's house ● If exhaust blows directly on passers-by because outdoor unit is installed facing a road. ● If exhaust blows directly on vegetation 	<ul style="list-style-type: none"> ● A minimum of 4 inches needed between the back of the outdoor unit and any obstructions (walls, etc.) 

Installation of Louvers

⚠ Caution

Attach the louvers overlapping the standard grill.
Installing the louvers without the grill would allow hands to enter the fan area, which is dangerous, so be sure to install the standard grill.

When pointing up

- (1) Remove the 4 attachment screws from the standard grill.

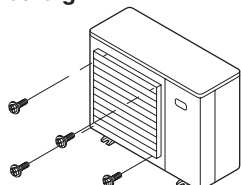

- (2) Install the louver pointed up.

- Overlap the standard grill and screw both in together.
- The attachment screws are in the louvers.

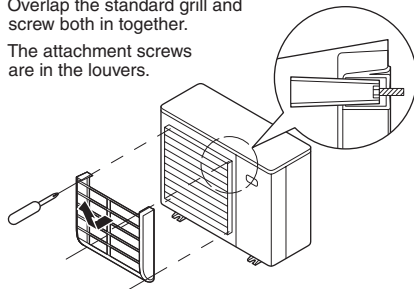

- (3) Installation complete

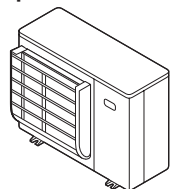

When pointing down

- (1) Remove the 4 attachment screws from the standard grill.

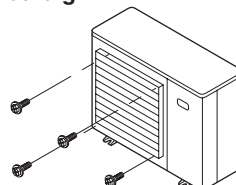

- (2) Install the louver pointed down.

- Overlap the standard grill and screw both in together.
- The attachment screws are in the louvers.

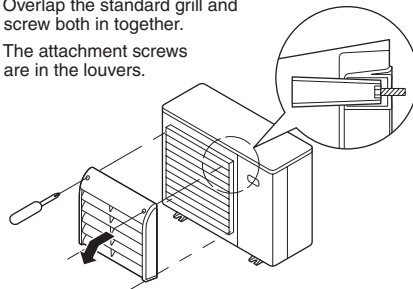

- (3) Installation complete

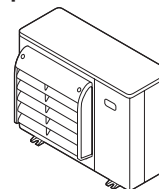

3P089958-2C



- Daikin Industries, Ltd.'s products are manufactured for export to numerous countries throughout the world. Daikin Industries, Ltd. does not have control over which products are exported to and used in a particular country. Prior to purchase, please therefore confirm with your local authorized importer, distributor and/or retailer whether this product conforms to the applicable standards, and is suitable for use, in the region where the product will be used. This statement does not purport to exclude, restrict or modify the application of any local legislation.
- Ask a qualified installer or contractor to install this product. Do not try to install the product yourself. Improper installation can result in water or refrigerant leakage, electrical shock, fire or explosion.
- Use only those parts and accessories supplied or specified by Daikin. Ask a qualified installer or contractor to install those parts and accessories. Use of unauthorized parts and accessories or improper installation of parts and accessories can result in water or refrigerant leakage, electrical shock, fire or explosion.
- Read the User's Manual carefully before using this product. The User's Manual provides important safety instructions and warnings. Be sure to follow these instructions and warnings.

If you have any inquiries, please contact your local importer, distributor and/or retailer.



© 2004 Daikin Industries, Limited.

Daikin®, Daikin AC™, Absolute Comfort™, VRV® and REFNET™ are trademarks pending or registered trademarks of Daikin Industries, Limited. All rights reserved. LonWorks® and LON® are registered trademarks of Echelon Corporation. BACnet® is a Data Communication Protocol for Building Automation and Control Networks, developed under the auspices of the American Society of Heating, Refrigerating and Air-Conditioning Engineers (ASHRAE).



JMI-0107



JQA-1452

About ISO 9001

ISO 9001 is a plant certification system defined by the International Organization for Standardization (ISO) relating to quality assurance. ISO 9001 certification covers quality assurance aspects related to the "design, development, manufacture, installation, and supplementary service" of products manufactured at the plant.



EC99J2044

About ISO 14001

ISO 14001 is the standard defined by the International Organization for Standardization (ISO) relating to environmental management systems. Our group has been acknowledged by an internationally accredited compliance organisation as having an appropriate programme of environmental protection procedures and activities to meet the requirements of ISO 14001.

Dealer

DAIKIN AC (AMERICAS), INC.
 1645 Wallace Drive, Suite 110
 Carrollton, TX75006
 info@daikinac.com
 www.daikinac.com

©All rights reserved

● Specifications, designs and other content appearing in this brochure are current as of January 2009 but subject to change without notice.