



Safety Considerations

Give this installation manual to the customer when installation is completed.

- Read these **Safety Considerations** carefully to ensure correct installation.
- Be sure to complete trial operation of the air conditioner / heat pump, in advance, in accordance with the instructions in the installation manual for the air conditioner / heat pump.
- Meanings of **WARNING** and **CAUTION** symbols:

WARNING: Indicates a potentially hazardous situation which, if not avoided, could result in death or serious injury.

CAUTION: Indicates a potentially hazardous situation which, if not avoided, may result in minor or moderate injury. It may also be used to alert against unsafe practices.

- **WARNING**
 - Only qualified personnel must carry out the installation work. Installation must be done in accordance with this installation manual. Improper installation may result in electric shock, fire, or equipment damage.
 - Use only specified accessories and parts for installation work. Failure to use specified parts may result in electric shock, fire, or equipment damage.
 - Before touching electrical parts, turn off the air conditioner / heat pump.
 - Electrical work must be performed in accordance with relevant local and national regulations and with the instructions in this installation manual. Always use a dedicated circuit. Failure to comply may result in electric shock or fire.
 - Do not disassemble, modify, or repair. Doing so may result in fire, electric shock, or injury.
 - Do not handle this product with wet hands. Doing so may result in electric shock or fire.
 - Do not allow this product to get wet or use it when bathing or similar activities using water. Failure to comply may result in electric shock or fire.

- Do not use this product near medical equipment or persons using cardiac pacemakers or defibrillators. This product may cause life-threatening electromagnetic interference.
- Do not use this product near auto-control equipment such as automatic doors or fire alarm equipment. Doing so may result in accidents due to malfunctioning.
- Immediately turn off the circuit breaker for the air conditioner / heat pump if there is an abnormal odor or sound, the unit is overheating, or smoke is emanating from the unit. There is a risk of fire or malfunction. Request an inspection by your dealer.
- Turn off the circuit breaker for the air conditioner / heat pump if the product was dropped or the case is damaged. There is a risk of fire or electric shock. Request an inspection by your dealer.
- Do not install the wireless LAN connection adapter in the plenum of the building. Doing so may result in fire.

- **CAUTION**
 - Do not install this product where gas leakage could be exposed to open flames. If the gas leaks and builds up around the product, it may catch fire.
 - Touch a nearby metal object (doorknob, aluminum sash, etc.) to discharge static electricity from your body before touching this set. Static electricity from your body can damage this set.
 - Grip the connector when disconnecting the connection cord from the outlet. Otherwise fire or electric shock can occur.
 - Do not use where small children can get access. There is a risk of injury to small children.

- Do not use this product near a microwave oven. This can affect wireless LAN communications.

Accessories

(A) Wireless LAN connection adapter	1	(B) Serial number sticker *1	1	(C) Installation manual (multi-language)	1
(D) Connection cord (1.6m) *2	1	(E) Fastening tape	1	(F) Mounting screw	2
(G) Home automation printed-circuit board (HA PCB) *3	1	(H) Harness (with ferrite core) *3	1	(J) Harness (without ferrite core) *3	1

- *1 Attach to the sticker attachment area on this document and keep safe.
- *2 Do not use extension or other cords.
- *3 Not used with air conditioners fitted with an S21 connector.

[About the SSID and KEY]

• The [SSID] and [KEY] shown on the (B) serial number sticker are necessary when connecting the air conditioner and a smartphone via wireless LAN.

[Sticker attachment area]

Attach the (B) serial number sticker to the sticker attachment area and keep safe.

Names of Parts

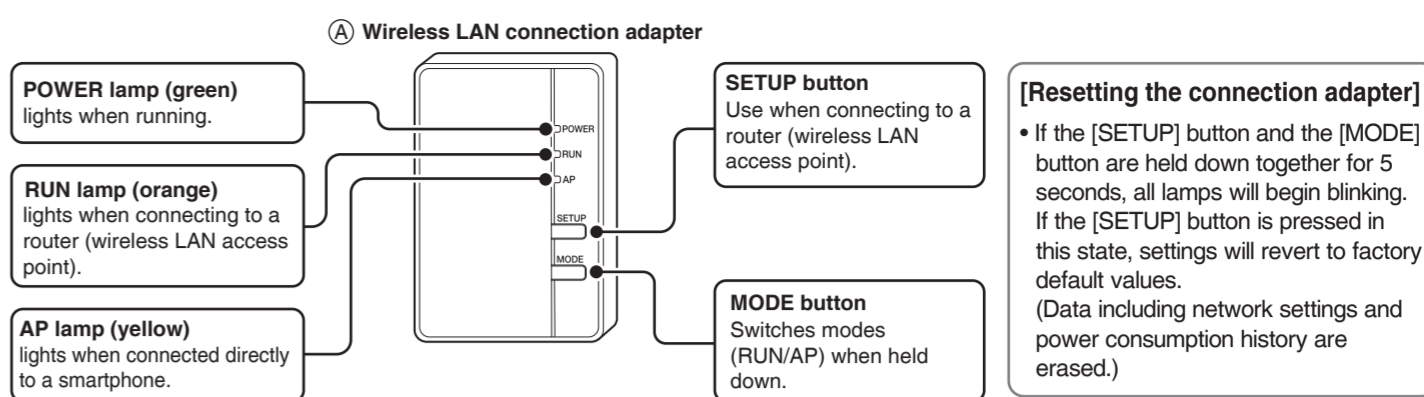

Installation Position

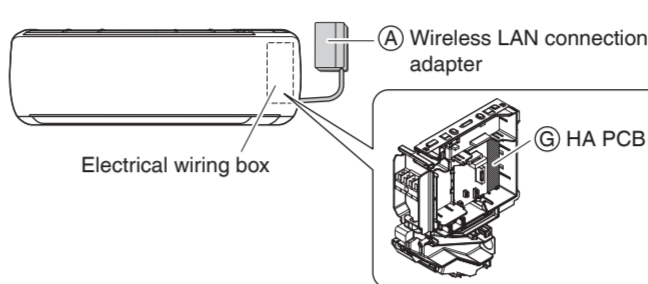

Wiring Outline

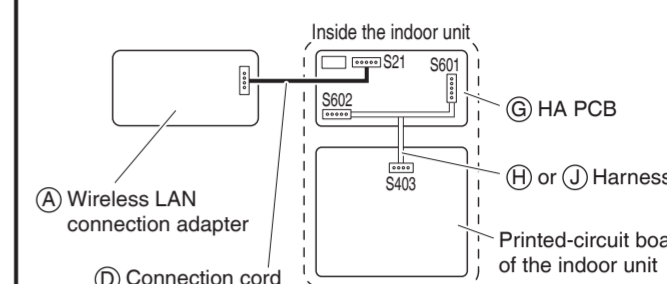

HA PCB Installation Procedure (1)

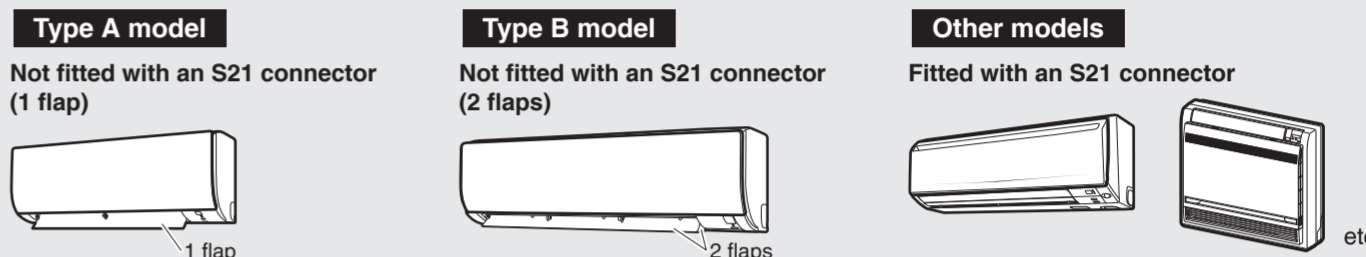

- WARNING**
Be sure to turn OFF the power at the time of installation work. Touching any electric parts with the power turned ON may cause electric shock.

1. Remove the front panel, service lid, and front grille in accordance with the installation manual for the air conditioner.

2. Install the (G) HA PCB.
Installation procedures for the (G) HA PCB differ by model type. Refer to the relevant section.

For **Type A model** ⇒ Proceed to "HA PCB Installation Procedure (2) **Type A**"

For **Type B model** ⇒ Proceed to "HA PCB Installation Procedure (2) **Type B**"

For **Other models** ⇒ Connect the (D) connection cord to the S21 connector in accordance with the installation manual for the air conditioner. (It is not necessary to install the (G) HA PCB.) After making the connection, return the front grille, service lid, and front panel to their original positions.

HA PCB Installation Procedure (2) Type A

3. Remove the electrical wiring box cover.
• Disengage the hooks to remove the electrical wiring box cover.

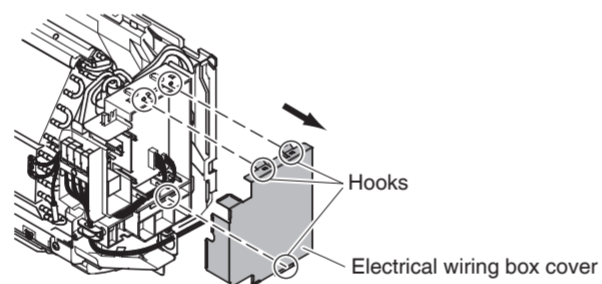

4. Remove the electrical wiring box (if necessary).

If there is workspace on the right-hand side of the indoor unit, the installation work can be conducted without removing the electrical wiring box. Connect the (G) HA PCB without removing the electrical wiring box, if possible.

- 1) Disconnect the inter-unit wire.
- 2) Disconnect the fan motor connector (S200) and swing motor connector (S6).
- 3) Disconnect the thermistor and ground wire from the heat exchanger (2 screws). (Some models may not have ground wire.)
- 4) Remove the mounting screw of the electrical wiring box (1 screw).

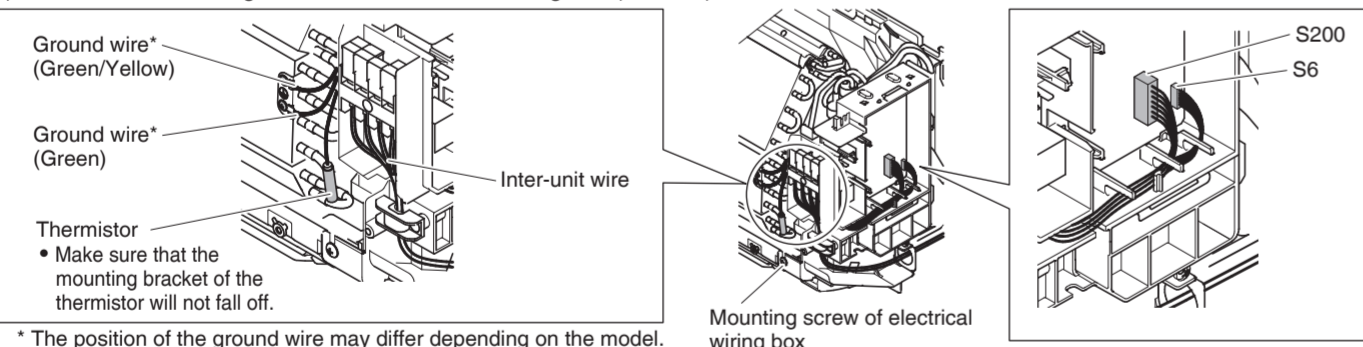

5. Install the HA PCB to the electrical wiring box.

- 1) Attach the (H) harness (with ferrite core), by connecting it to the S601 and S602 connectors on the (G) HA PCB. (See Fig. 2)
- 2) Insert the connector of the (H) harness (with ferrite core) into the S403 connector on the electrical wiring box. (See Fig. 2)
- 3) Install the (G) HA PCB to the electrical wiring box. (See Fig. 2)
- 4) Insert the (D) connection cord into the S21 connector (white) on the (G) HA PCB. (See Fig. 3)
• Insert the connector of the (D) connection cord without the cord anchor. (See Fig. 1)
- 5) Route the (D) connection cord as shown in the figure. (See Fig. 3)

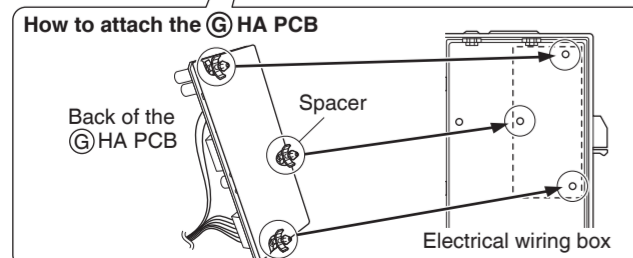
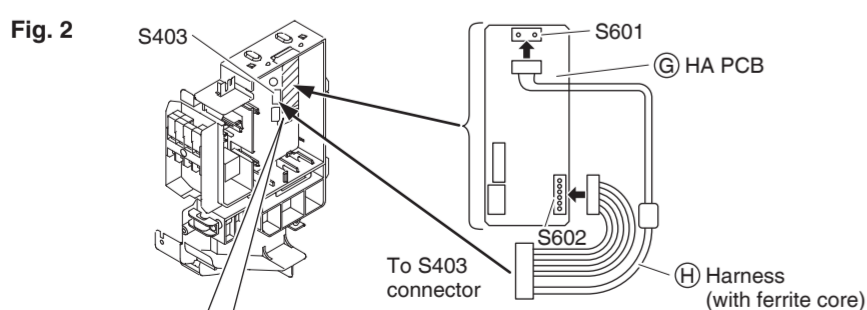

6. Return the electrical wiring box cover and electrical wiring box (if it was removed) to their original positions.

7. Return the front grille, service lid, and front panel to their original positions in accordance with the installation manual for the air conditioner.

HA PCB Installation Procedure (2) Type B

3. Remove the electrical wiring box cover.
• Disengage the hooks to remove the electrical wiring box cover.

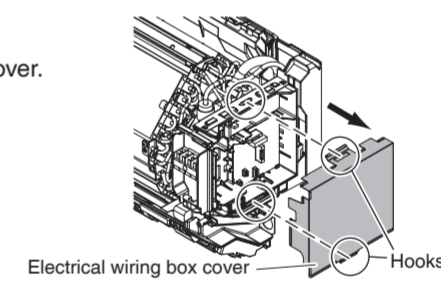

4. Remove the electrical wiring box (if necessary).

If there is workspace on the right-hand side of the indoor unit, the installation work can be conducted without removing the electrical wiring box. Connect the (G) HA PCB without removing the electrical wiring box, if possible.

- 1) Disconnect the inter-unit wire.
- 2) Disconnect the fan motor connector (S200) and swing motor connector (S6).
- 3) Disconnect the thermistor and ground wire from the heat exchanger (2 screws). (Some models may not have ground wire.)
- 4) Remove the mounting screw of the electrical wiring box (1 screw).

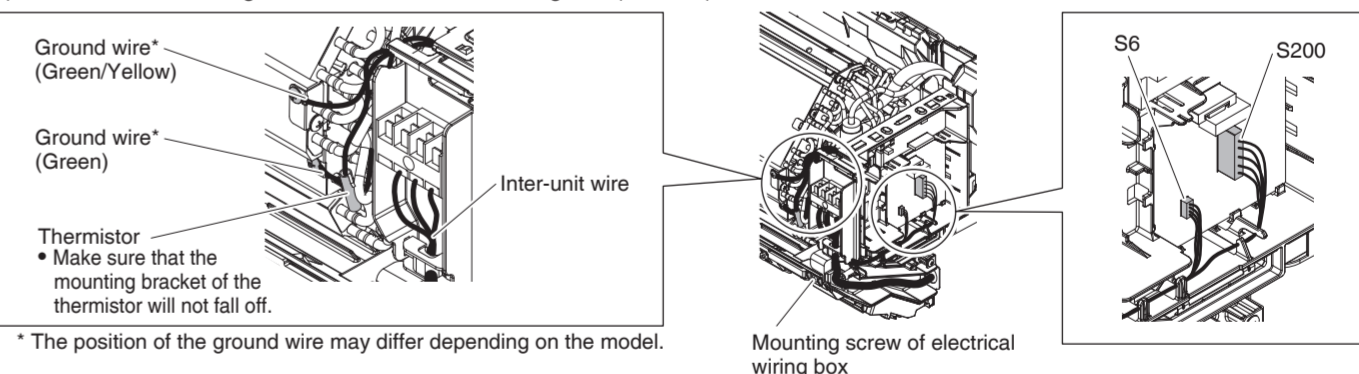

5. Install the HA PCB to the electrical wiring box.

- 1) Attach the (J) harness (without ferrite core), by connecting it to the S601 and S602 connectors on the (G) HA PCB. (See Fig. 2)
- 2) Insert the connector of the (J) harness (without ferrite core) into the S403 connector on the electrical wiring box. (See Fig. 2)
- 3) Install the (G) HA PCB to the electrical wiring box. (See Fig. 2)
- 4) Insert the (D) connection cord into the S21 connector (white) on the (G) HA PCB. (See Fig. 3)
• Insert the connector of the (D) connection cord without the cord anchor. (See Fig. 1)
- 5) Route the (D) connection cord as shown in the figure. (See Fig. 3)

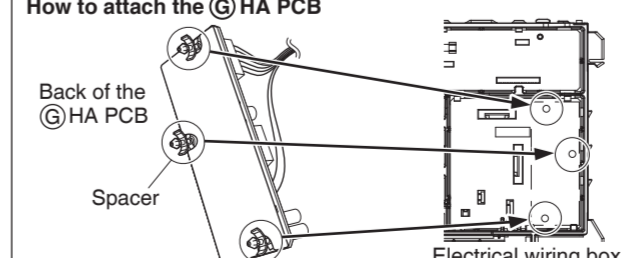
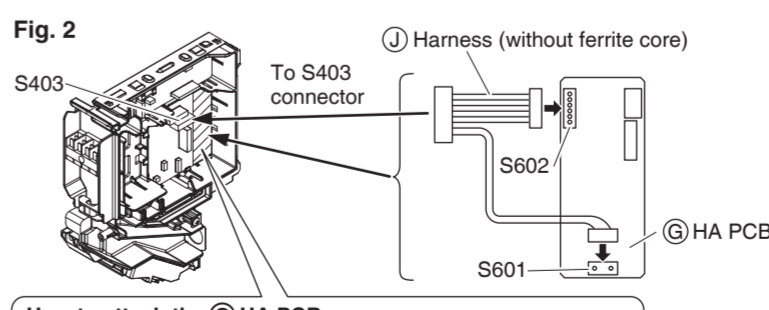

6. Return the electrical wiring box cover and electrical wiring box (if it was removed) to their original positions.

7. Return the front grille, service lid, and front panel to their original positions in accordance with the installation manual for the air conditioner.

Wireless LAN Connection Adapter Installation Procedure All types

The following procedures are also applicable to air conditioners fitted with an S21 connector.

1. Remove the upper case of the **(A)** wireless LAN connection adapter.

Press a slot-head screwdriver* into the dent between the upper and lower cases of the **(A)** wireless LAN connection adapter to remove. (Be careful not to damage the case.)
* Use a slot-head screwdriver with a wide head (0.2 inches (5mm) or wider is recommended).

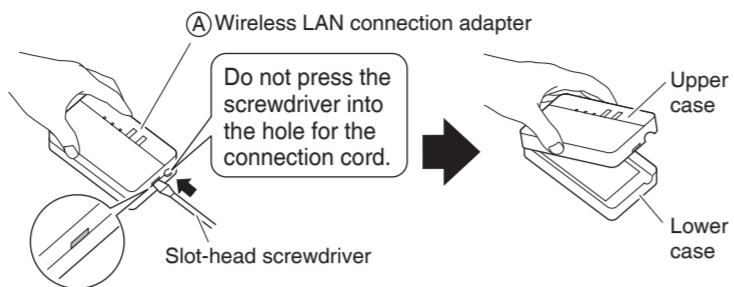

2. Attach the **(D)** connection cord to the **(A)** wireless LAN connection adapter.

- 1) Attach the connector of the **(D)** connection cord.
- 2) Fasten the **(D)** connection cord to the notch in the lower case of the **(A)** wireless LAN connection adapter.

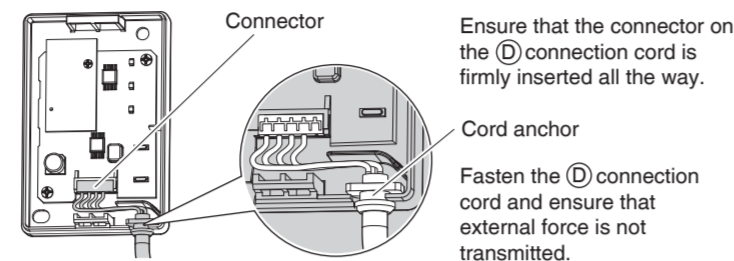

3. Install the lower case of the **(A)** wireless LAN connection adapter to a wall, a pillar, or similar location.

- Install the lower case so as to allow the upper case to be easily removed for maintenance purposes.
- Do not install outdoors or anywhere it is likely to get wet.
- Do not install it near the sensor part of the indoor unit.

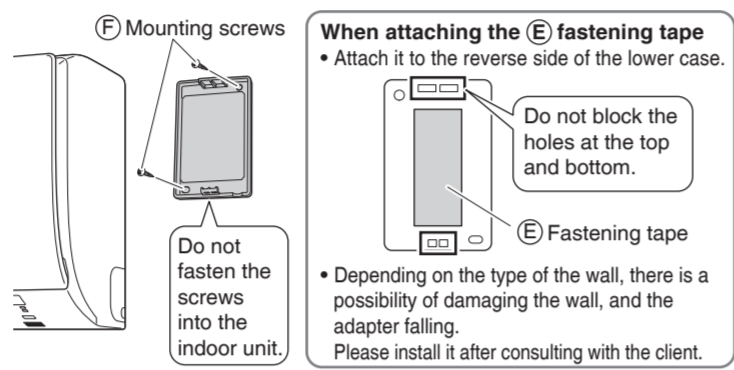

4. Return the adapter case to its original condition.

Close the adapter by hooking the top of the upper case on the top clip of the lower case.

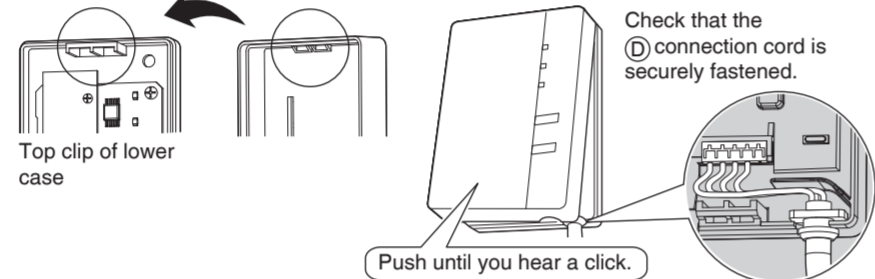

5. Turn on the power supply, wait until the initialization is complete, and check that the **[POWER]** lamp of the **(A)** wireless LAN connection adapter lights up.

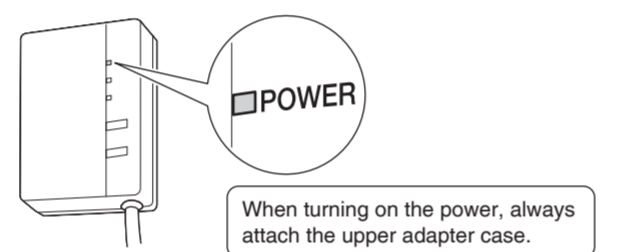

Preparation Before Configuring Connection Settings All types

The customer is responsible for providing the following.

- Smartphone or tablet PC (Supported OS: Android 4.0.3 or later; iOS 7.0 or later.)
- Internet line and communicating device (Modem/router or a similar device)
- Wireless LAN access point (The corresponding channel for the wireless LAN connection adapter is 1-11.)
- [DAIKIN Mobile Controller] (No Cost)

Installation method of online controller

For Android Phones/Tablets	For iPhones/iPads
(1) Open the [Google Play].	(1) Open the [App Store].
(2) Search for [Daikin Comfort Control].	(2) Search for [Daikin Comfort Control].
(3) Follow the directions on the screen to install.	(3) Follow the directions on the screen to install.

Configuring Connection Settings (1) All types

Check whether the router to be used supports WPS.

If WPS is supported → Proceed to **Simple setup** If WPS is not supported → Proceed to **Advanced setup**

Simple setup

1. Check that the **[POWER]** lamp is continuously lit and the **[RUN]** lamp is blinking.

- If the **[POWER]** lamp is lit and the **[RUN]** lamp is not lit, hold down the **[MODE]** button on the adapter for about 2 seconds to prompt the **[RUN]** lamp to begin blinking. (Blinking begins in about 30 seconds.)

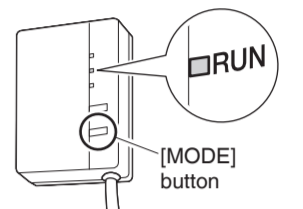

2. Press the **[WPS]** button on the router (wireless LAN access point).

- Operation procedures for the **[WPS]** button vary by router (wireless LAN access point). For details, refer to the instruction manual for the router.

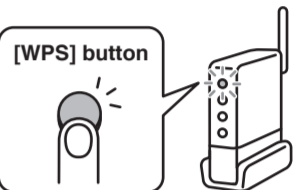

3. Hold down the **[SETUP]** button on the adapter for about 2 seconds.

- The **[RUN]** lamp will begin to blink more rapidly, and will change to a continuous light once a connection between the router (wireless LAN access point) and the adapter has been established. If a connection fails to establish, repeat procedures from step 1 of "Simple setup". If a connection still cannot be established, follow the procedures in "Advanced setup". (In some cases, a connection cannot be established using the steps in "Simple setup" owing to compatibility issues.)

4. Connect the smartphone (tablet PC) and the router (wireless LAN access point).

- A connection can be established by opening the smartphone's Wi-Fi network list, selecting the **[SSID]** for the router and entering its password.

5. Tap the installed app **[Daikin Comfort Control]** to start it.

- If the connected air conditioner is listed in the units overview screen, setup is complete. If it is not listed, tap **[refresh]** in the top right corner of the units overview screen.

Note

- If an upgrade is available for your adapter, the notification icon "u" will be displayed on the units overview screen. Tap it to upgrade your firmware.



Configuring Connection Settings (2) All types

Advanced setup • All steps are demonstrated using iOS.

1. Check that the **[AP]** lamp is lit (continuously). If the **[AP]** lamp is not lit, hold down the **[MODE]** button on the adapter for about 2 seconds to prompt the **[AP]** lamp to light up (continuously). (Lights in about 10 seconds.)

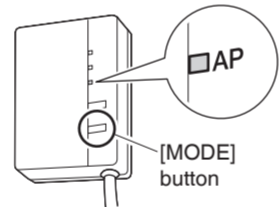

2. Connect the smartphone (tablet PC) directly with the adapter via wireless LAN.

- Open the smartphone's Wi-Fi network list, select the **[SSID]** (DaikinAP *****) shown on the **(B)** serial number sticker, or the **(A)** wireless LAN connection adapter, and then enter the **[KEY]**.

3. Tap the installed app **[Daikin Comfort Control]** to start it.

4. Make the wireless connection settings.

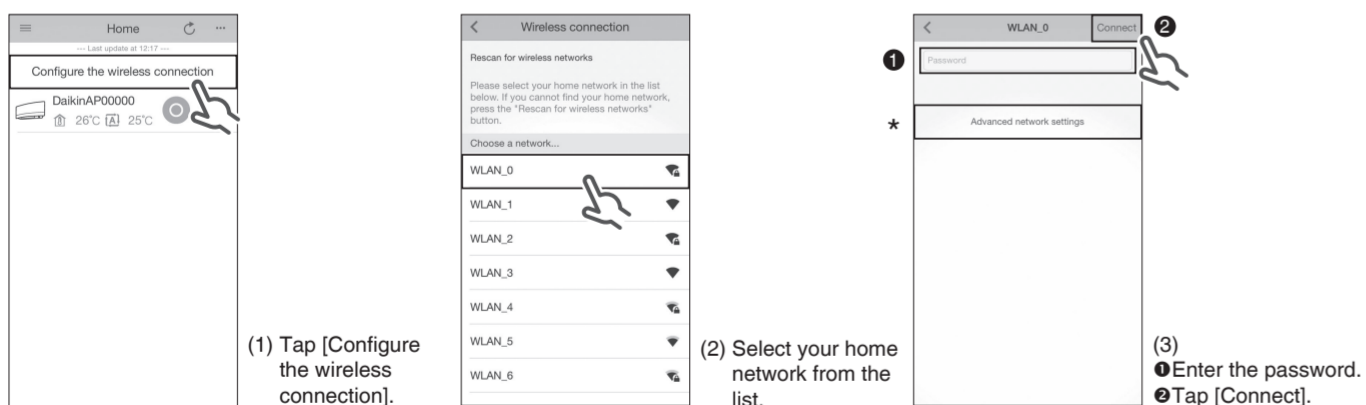

(4) Follow the on-screen instructions from here onward to complete setup.

(5) After implementing the setting above and the product and router (wireless LAN access point) are connected, the **[RUN]** lamp will light. If this blinks for 1 minute or longer, check the power to the router (wireless LAN access point), network name and the password and start again from the first procedure.

* To set the wireless connection manually, tap **[Advanced network settings]**, turn off **[Automatic IP address (DHCP)]**, fill in the required information for the Wi-Fi router, tap **[✓]** and then tap **[Connect]** on the wireless connection screen. Follow the on-screen instructions and then continue as in step (5).



5. Connect the smartphone (tablet PC) and the router (wireless LAN access point), and then start **[Daikin Comfort Control]**.

- Refer to step 4 and step 5 of "Simple setup".

Troubleshooting

The following table provides brief descriptions of how to handle problems or uncertainties when you install the product or make connection settings. Check our website for details.

URL

<http://daikincomfort.com/DuctlessWireless/FAQ>



• FAQ can be viewed via smartphone (tablet PC). To access, please scan the 2D barcode.

When this happens	Explanation and where to check
[RUN] lamp does not light up (continuously).	The [RUN] lamp blinks. → Perform Simple setup or Advanced setup again. → Check that the [SSID] and password for the adapter are entered correctly. → Move the router (wireless LAN access point) closer to the adapter. → The smartphone or router (wireless LAN access point) in use may not be supported. Check our website for details.

After-sale Service

For inquiries concerning after-sale service, contact your dealer and advise them of the following details:

- Model name
- Date of installation
- Conditions at the time of failure (as precisely as possible)
- Your address, name, and telephone number

This telecommunication equipment is in compliance with FCC/IC requirements.

FCC CAUTION

Changes or modifications not expressly approved by the party responsible for compliance could void the user's authority to operate the equipment.

This transmitter must not be co-located or operated in conjunction with any other antenna or transmitter.

This device complies with Part 15 of FCC Rules and Industry Canada license-exempt RSS standard(s). Operation is subject to the following two conditions: (1) this device may not cause interference, and (2) this device must accept any interference, including interference that may cause undesired operation of this device.

This equipment complies with FCC/IC radiation exposure limits set forth for an uncontrolled environment and meets the FCC radio frequency (RF) Exposure Guidelines and RSS-102 of the IC radio frequency (RF) Exposure rules. This equipment should be installed and operated keeping the radiator at least 8 inches (20cm) or more away from person's body.

Contains FCC ID:VPYLBVD
Contains IC: 772C-LBYD

GOODMAN MANUFACTURING COMPANY, L.P.

5151 San Felipe, Suite 500
Houston, TX 77056 USA

DAIKIN INDUSTRIES, LTD.

Head office:
Umeda Center Bldg., 2-4-12, Nakazaki-Nishi,
Kita-ku, Osaka, 530-8323 Japan

Tokyo office:
JR Shinagawa East Bldg., 2-18-1, Konan,
Minato-ku, Tokyo, 108-0075 Japan
<http://www.daikin.com>